

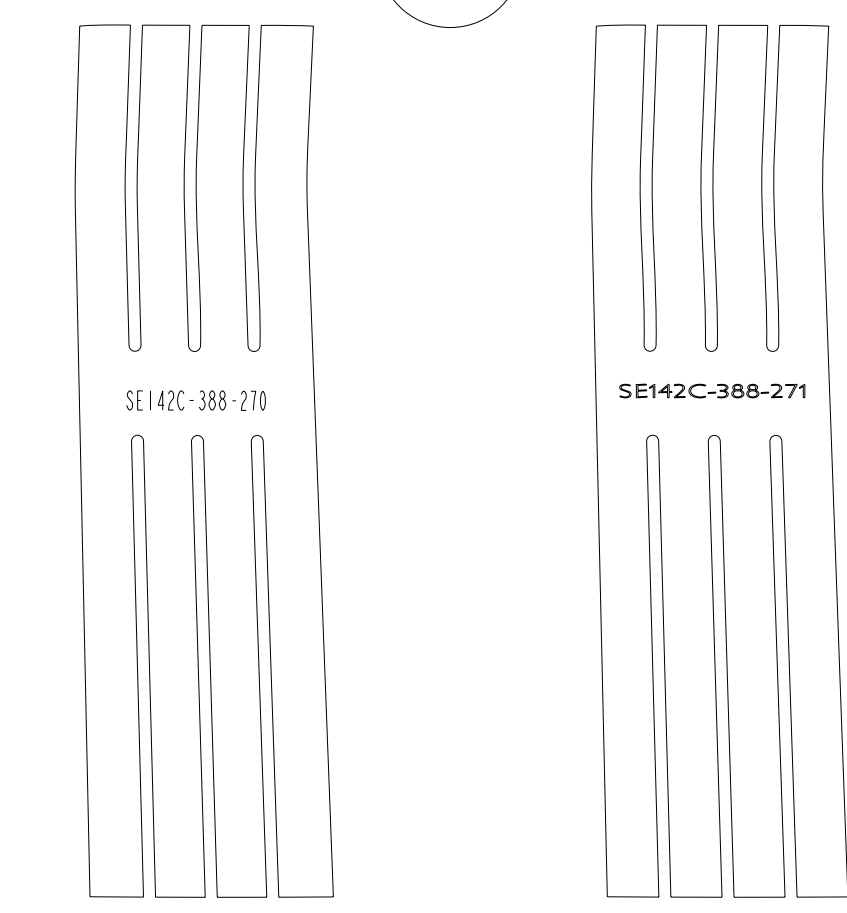



2

THESE PARTS TO BE NEMA GRADE G11CR MATERIAL



01

INSTANCE SE142C-388\_FLAT\_270  
INSTANCE SE142C-388\_FLAT\_271

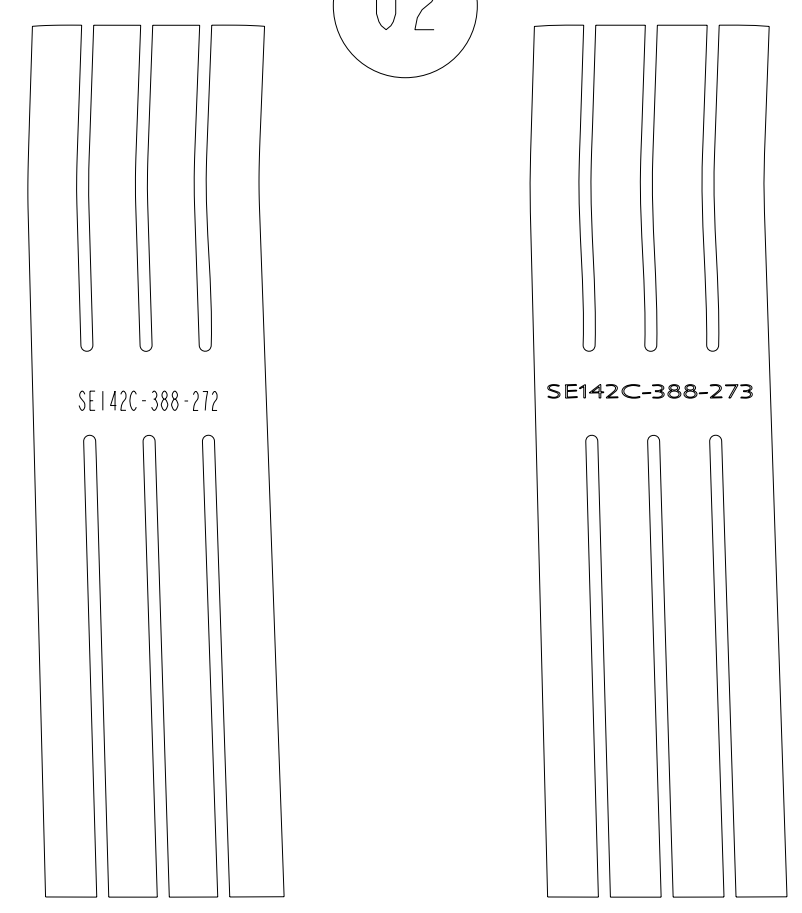

02

INSTANCE SE142C-388\_FLAT\_272  
INSTANCE SE142C-388\_FLAT\_273

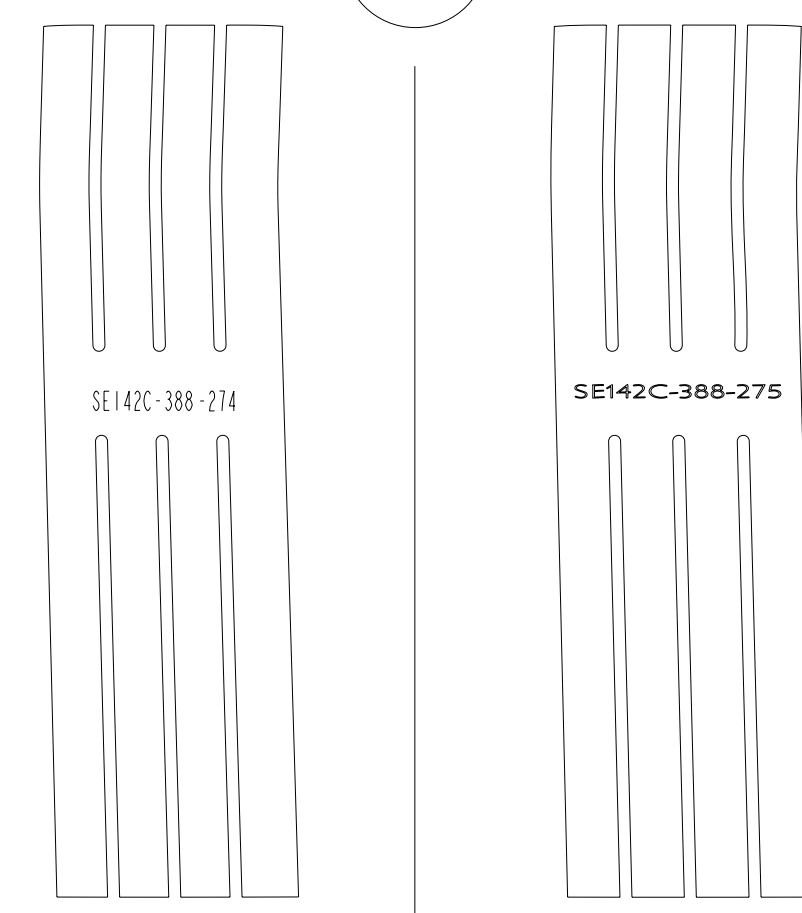

03

INSTANCE SE142C-388\_FLAT\_274  
INSTANCE SE142C-388\_FLAT\_275

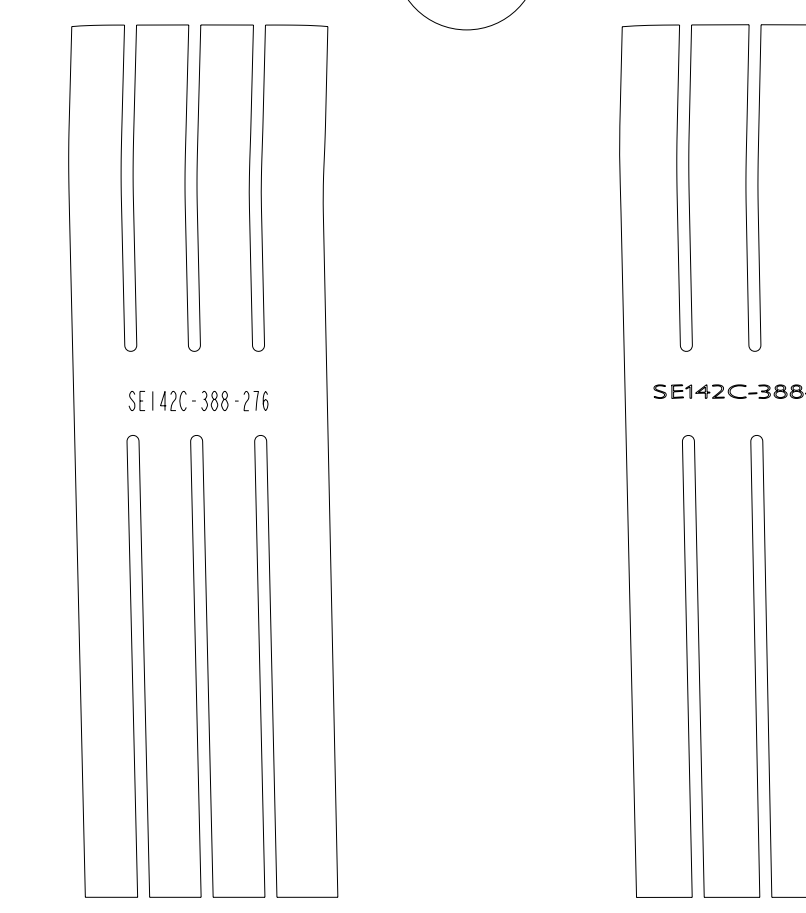

04

INSTANCE SE142C-388\_FLAT\_276  
INSTANCE SE142C-388\_FLAT\_277

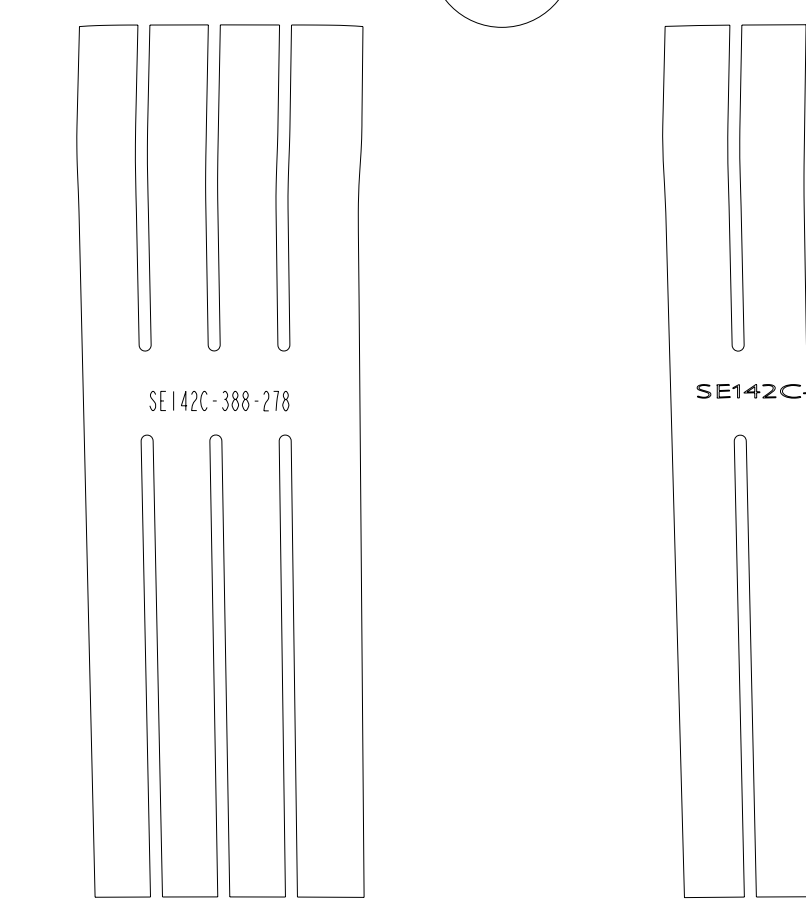

05

INSTANCE SE142C-388\_FLAT\_278  
INSTANCE SE142C-388\_FLAT\_279

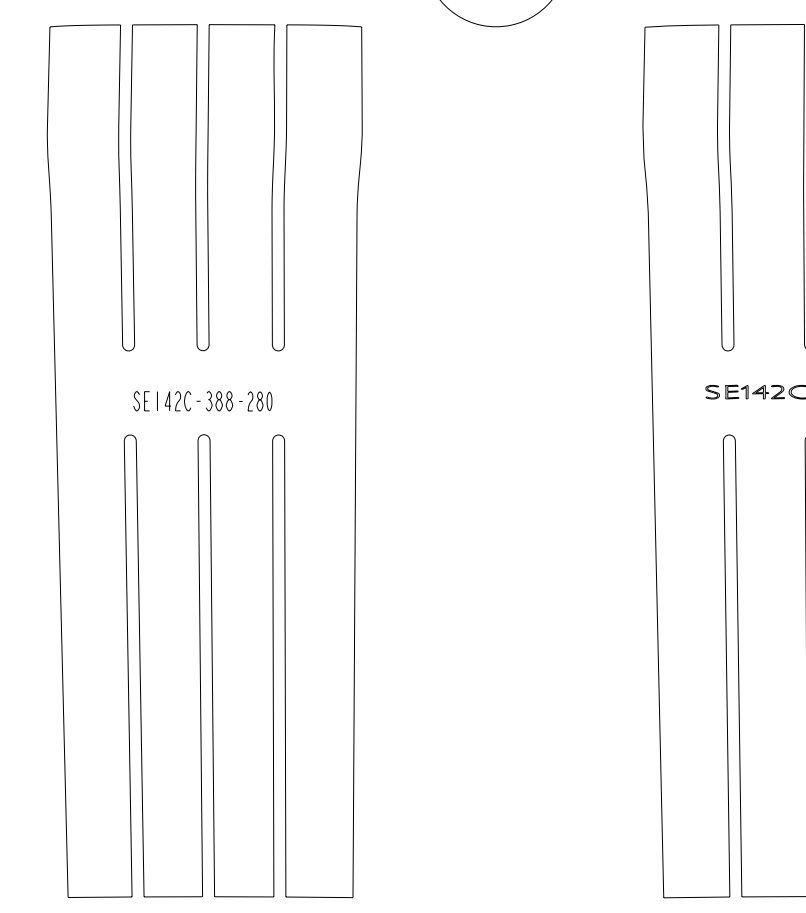

06

INSTANCE SE142C-388\_FLAT\_280  
INSTANCE SE142C-388\_FLAT\_281

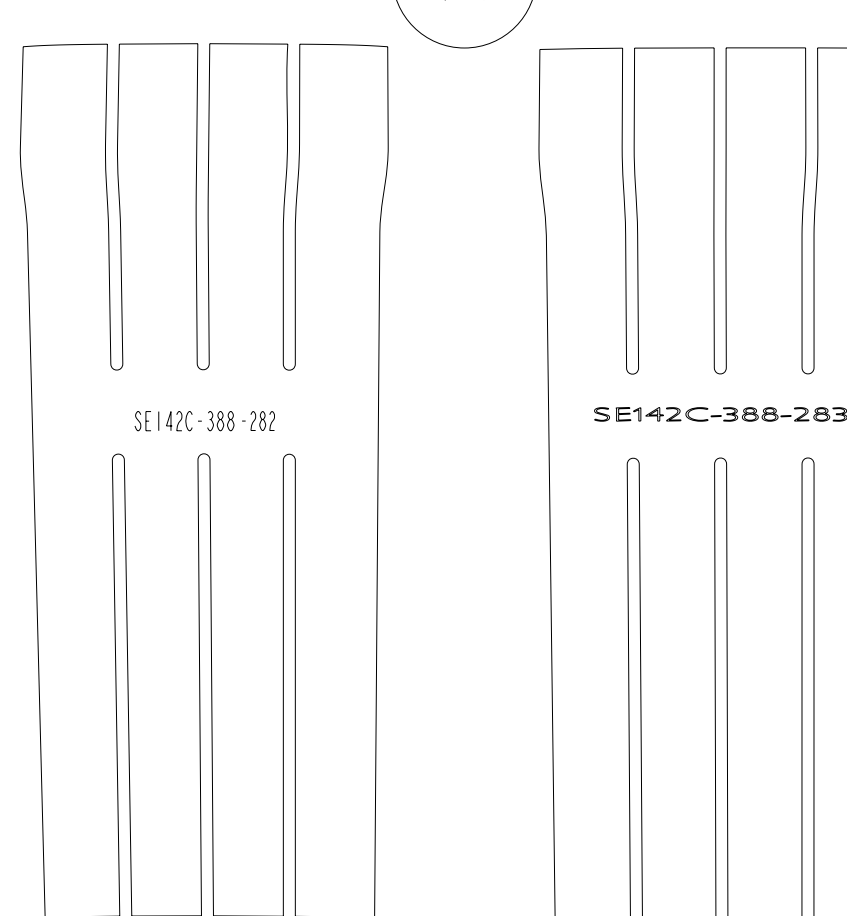

07

INSTANCE SE142C-388\_FLAT\_282  
INSTANCE SE142C-388\_FLAT\_283

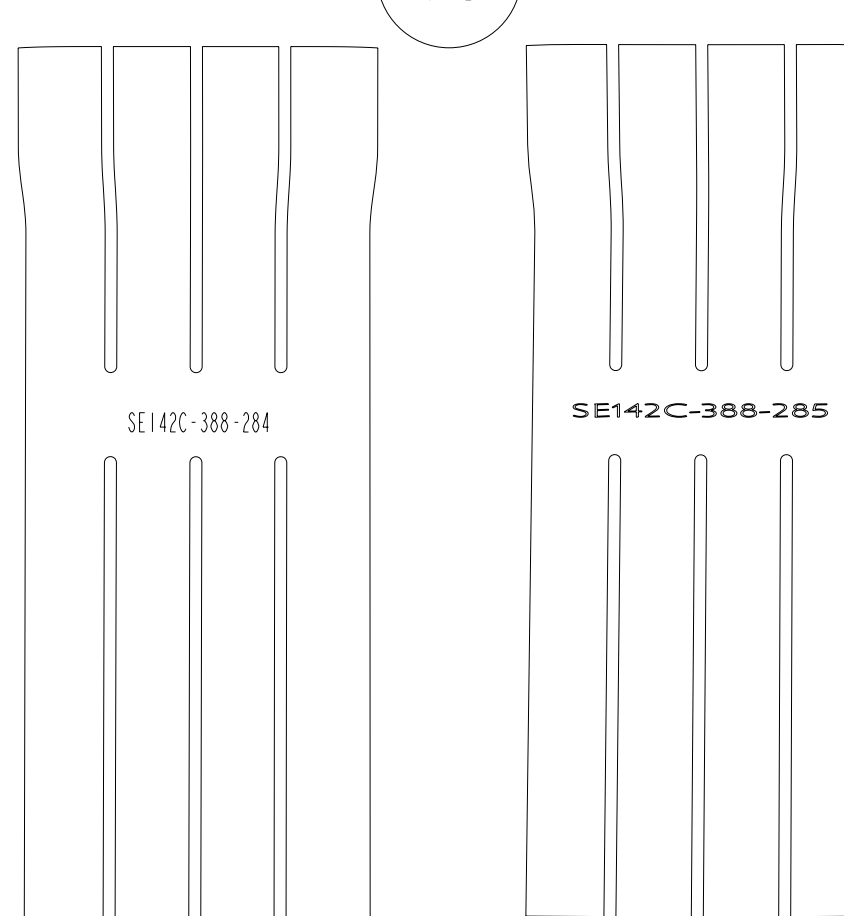

08

INSTANCE SE142C-388\_FLAT\_284  
INSTANCE SE142C-388\_FLAT\_285

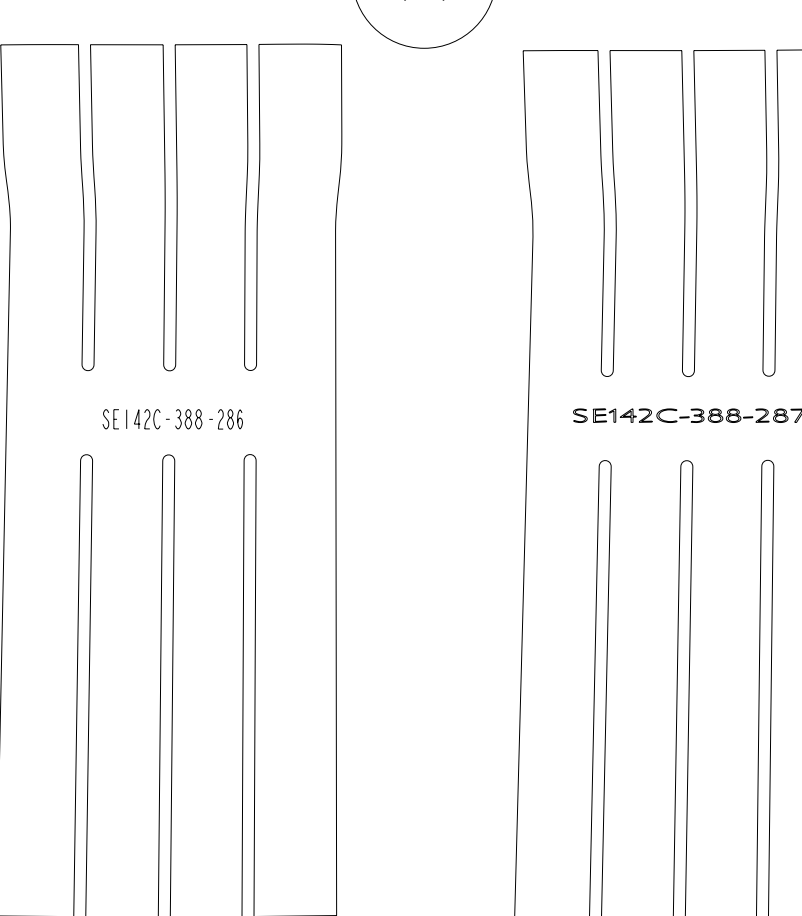

09

INSTANCE SE142C-388\_FLAT\_286  
INSTANCE SE142C-388\_FLAT\_287

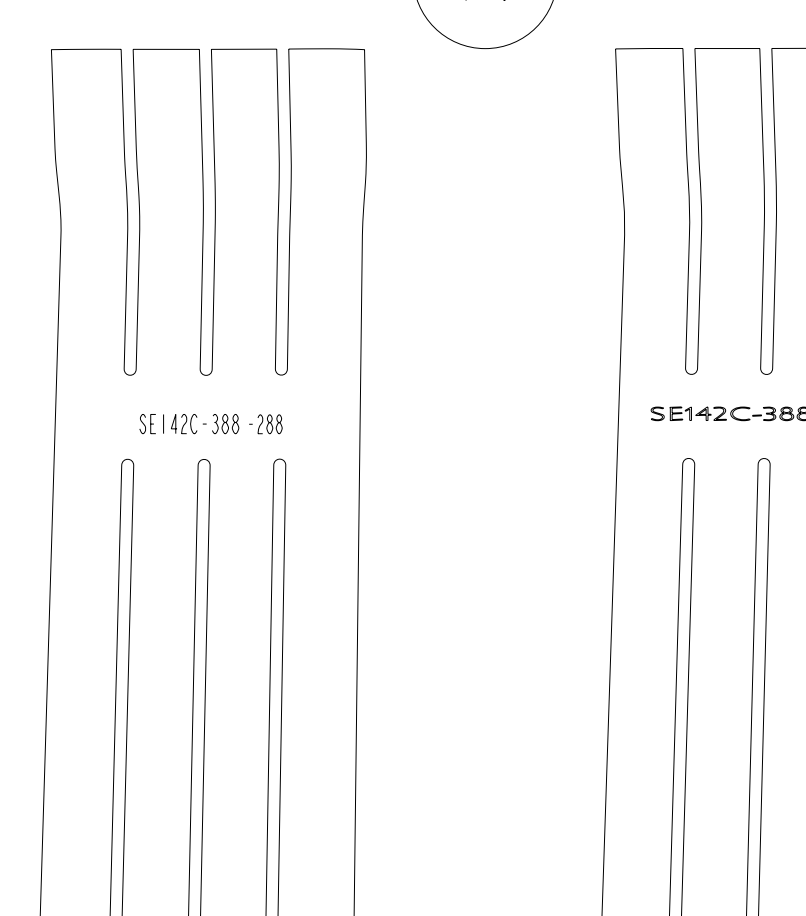

10

INSTANCE SE142C-388\_FLAT\_288  
INSTANCE SE142C-388\_FLAT\_289

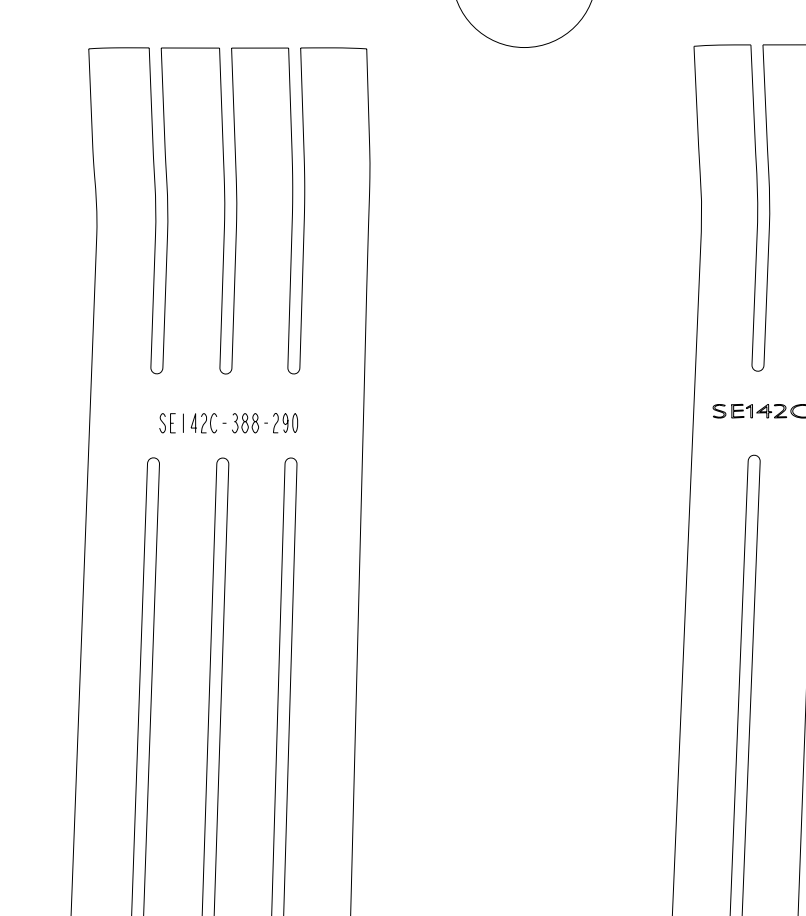

11

INSTANCE SE142C-388\_FLAT\_290  
INSTANCE SE142C-388\_FLAT\_291

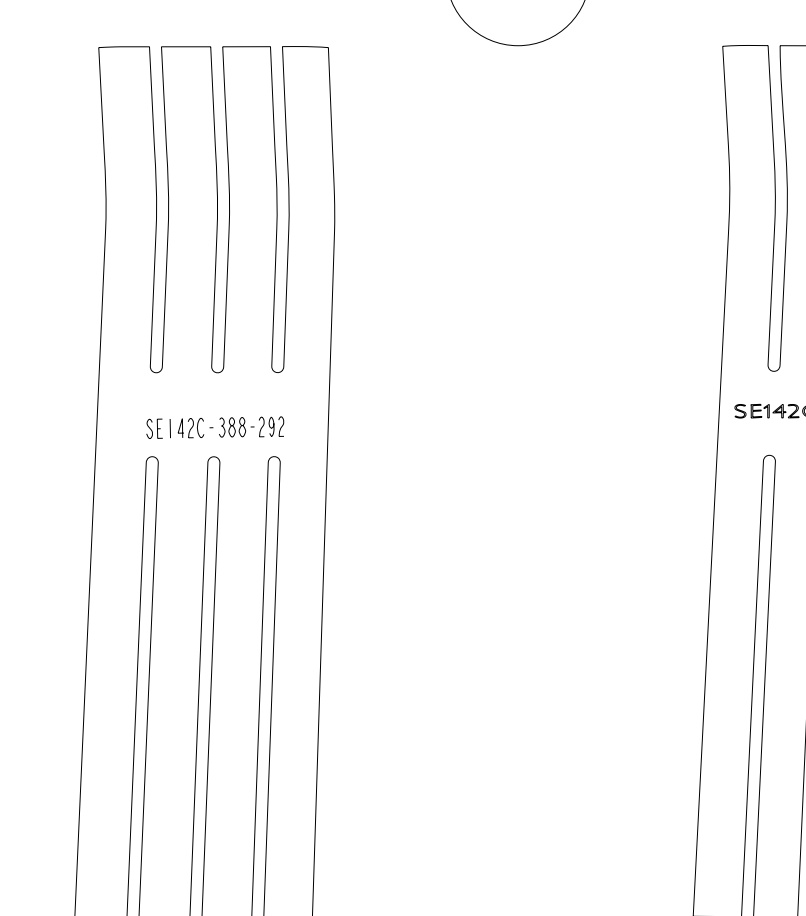

12

INSTANCE SE142C-388\_FLAT\_290\_NEW  
INSTANCE SE142C-388\_FLAT\_101

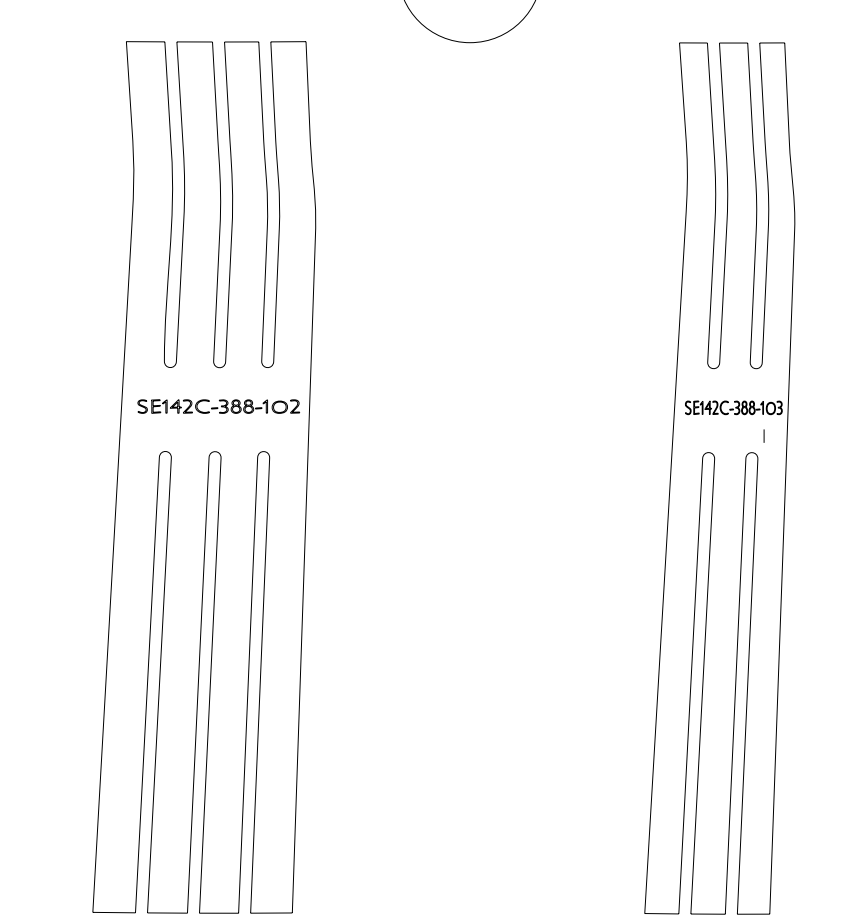

13

INSTANCE SE142C-388\_FLAT\_102  
INSTANCE SE142C-388\_FLAT\_103-NEW

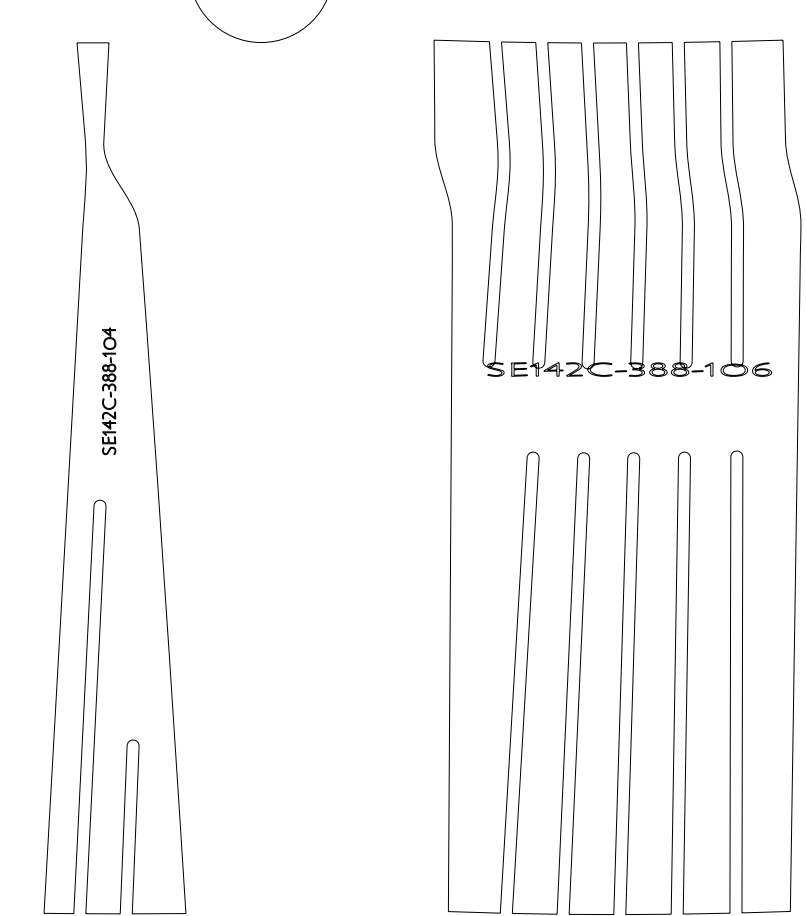

14

INSTANCE SE142C-388\_FLAT\_NEW\_104  
INSTANCE SE142C-388\_FLAT\_NEW\_106

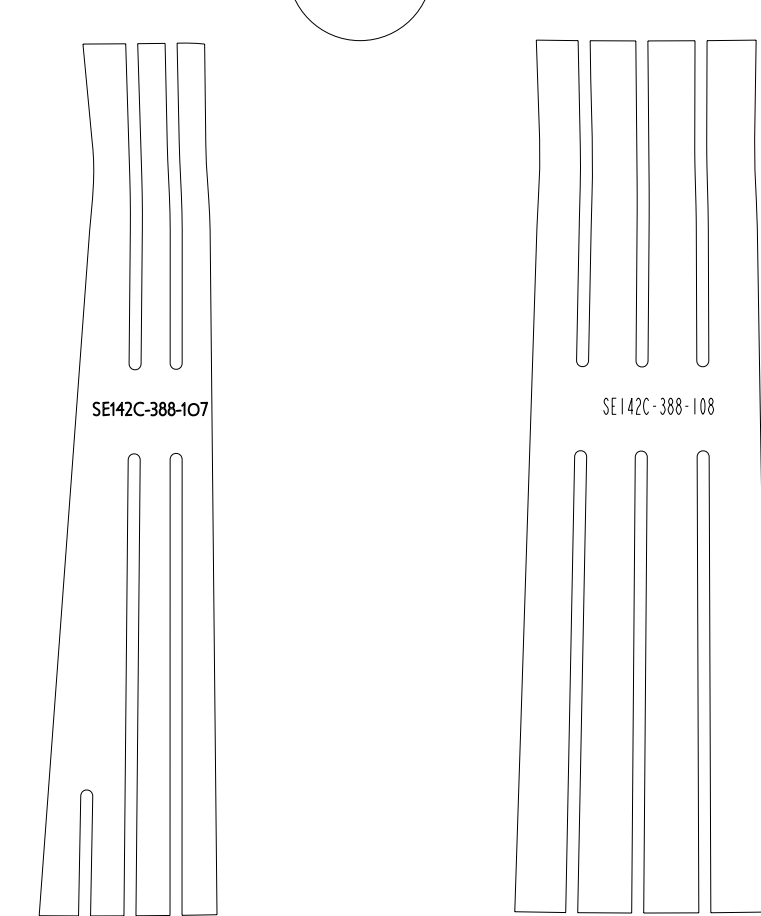

15

INSTANCE SE142C-388\_FLAT\_NEW\_107  
INSTANCE SE142C-388\_FLAT\_107-108

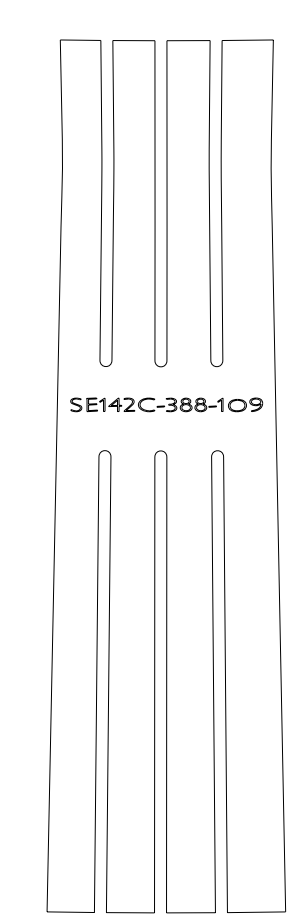

16

INSTANCE SE142C-388\_FLAT\_109

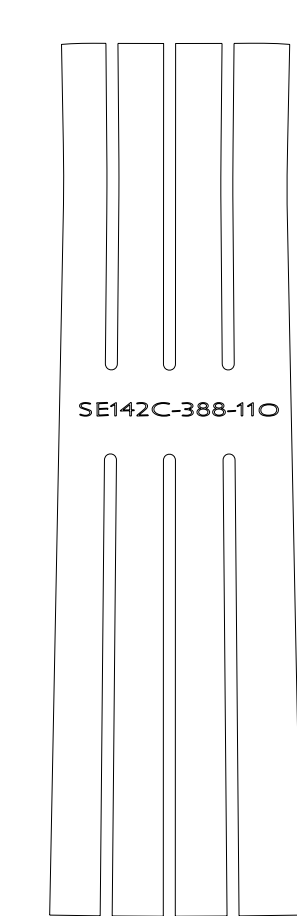

17

INSTANCE SE142C-388\_FLAT\_110  
INSTANCE SE142C-388\_FLAT\_111

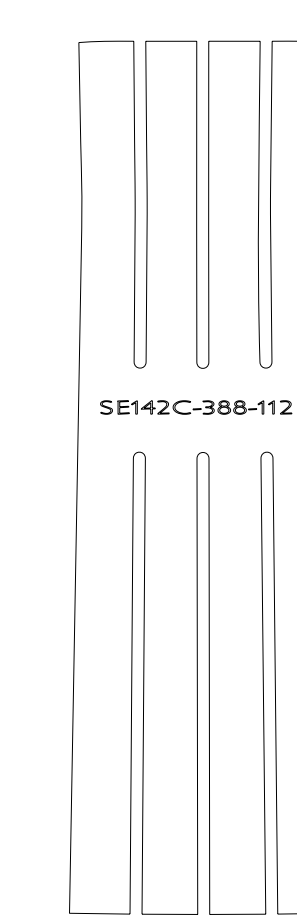

18

INSTANCE SE142C-388\_FLAT\_112  
INSTANCE SE142C-388\_FLAT\_113

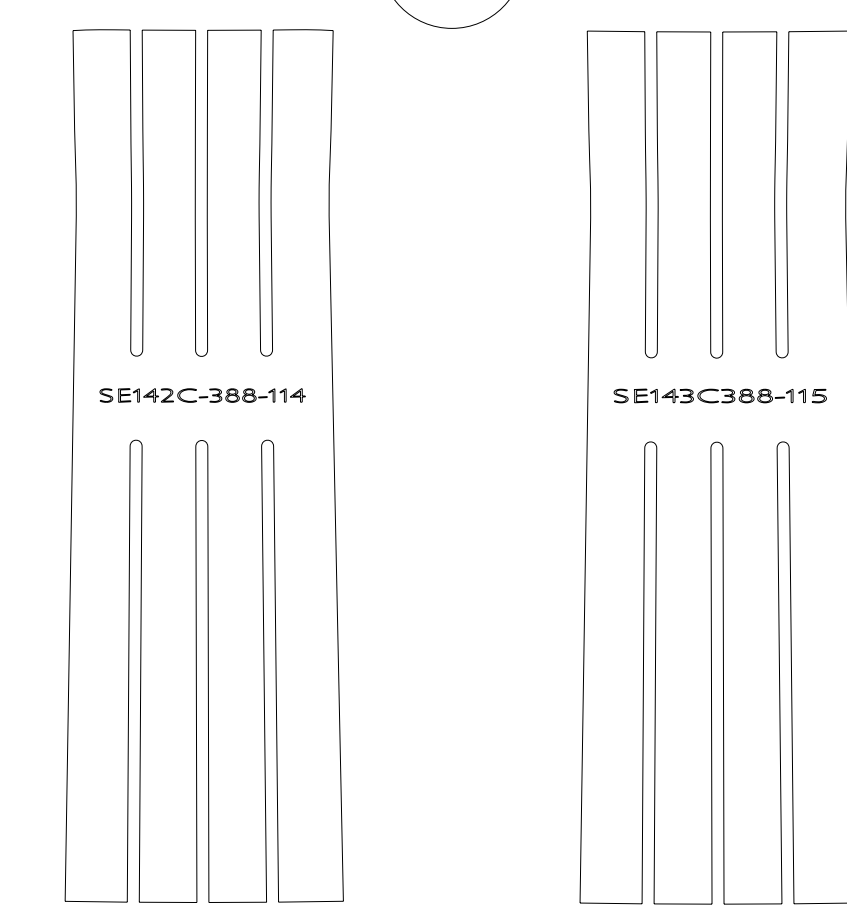

19

INSTANCE SE142C-388\_FLAT\_114  
INSTANCE SE142C-388\_FLAT\_115

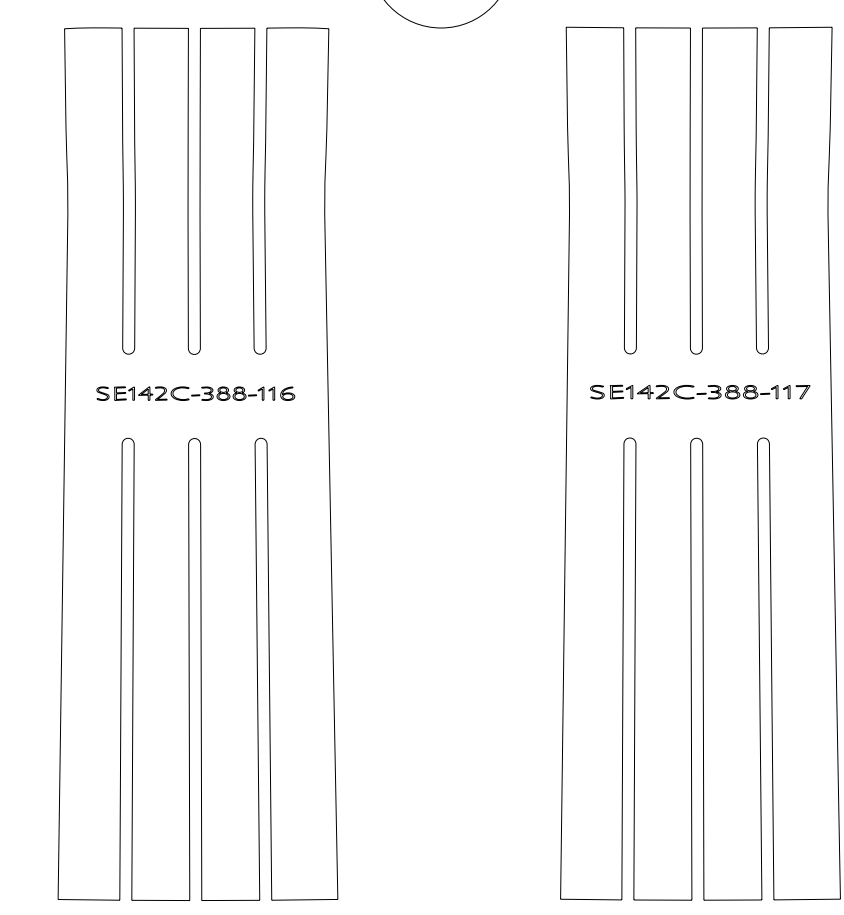

20

INSTANCE SE142C-388\_FLAT\_116  
INSTANCE SE142C-388\_FLAT\_117

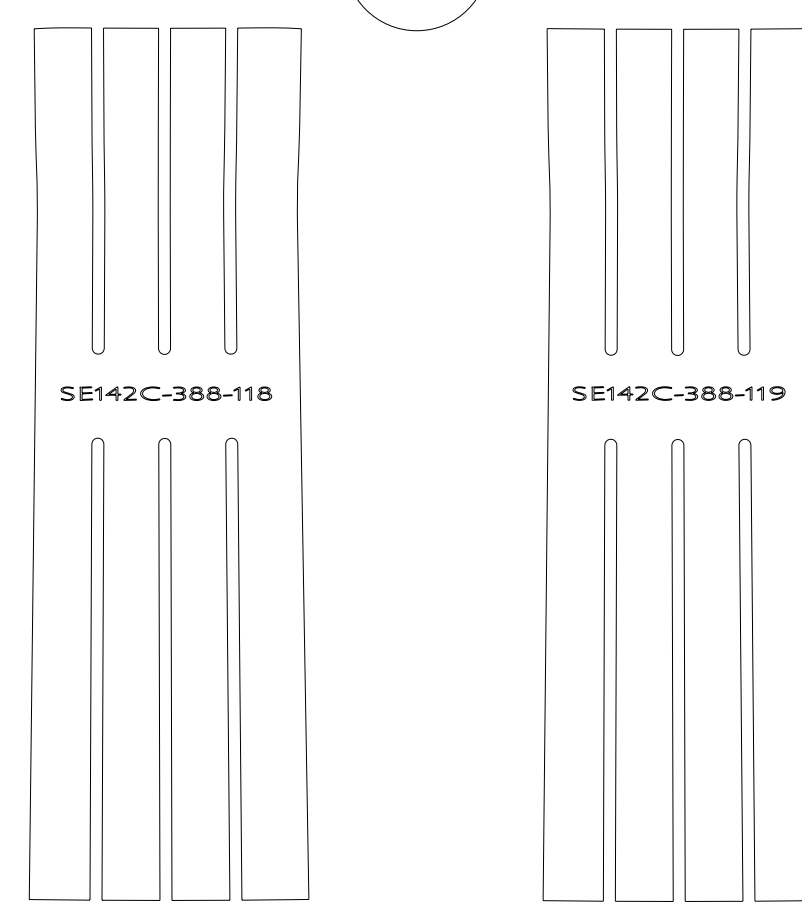

21

INSTANCE SE142C-388\_FLAT\_118  
INSTANCE SE142C-388\_FLAT\_119

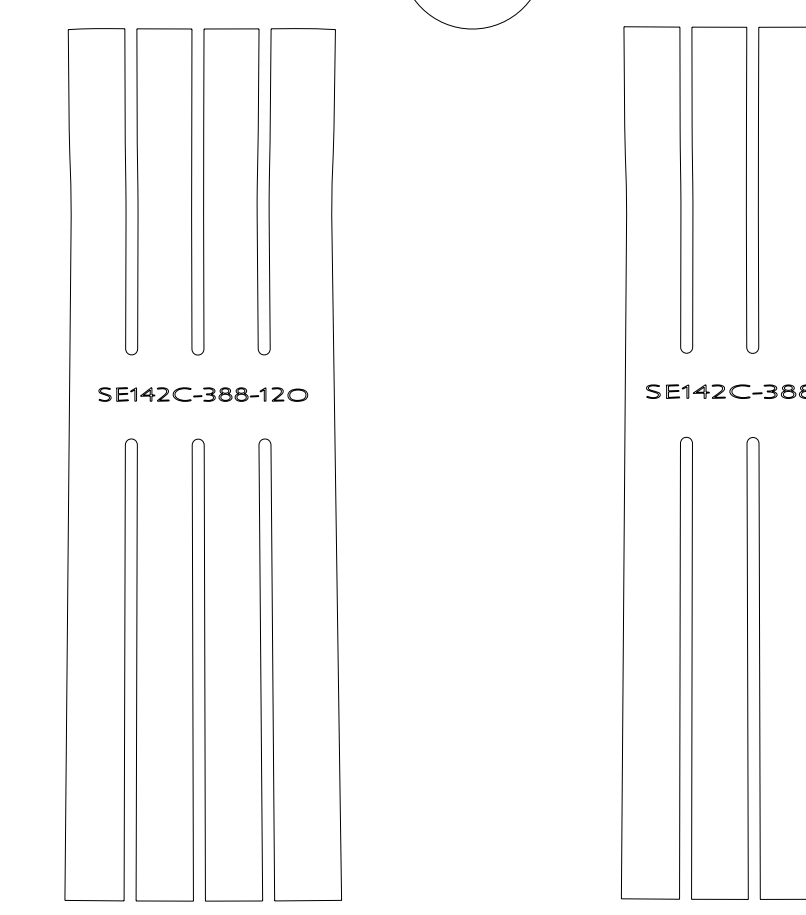

22

INSTANCE SE142C-388\_FLAT\_120  
INSTANCE SE142C-388\_FLAT\_121

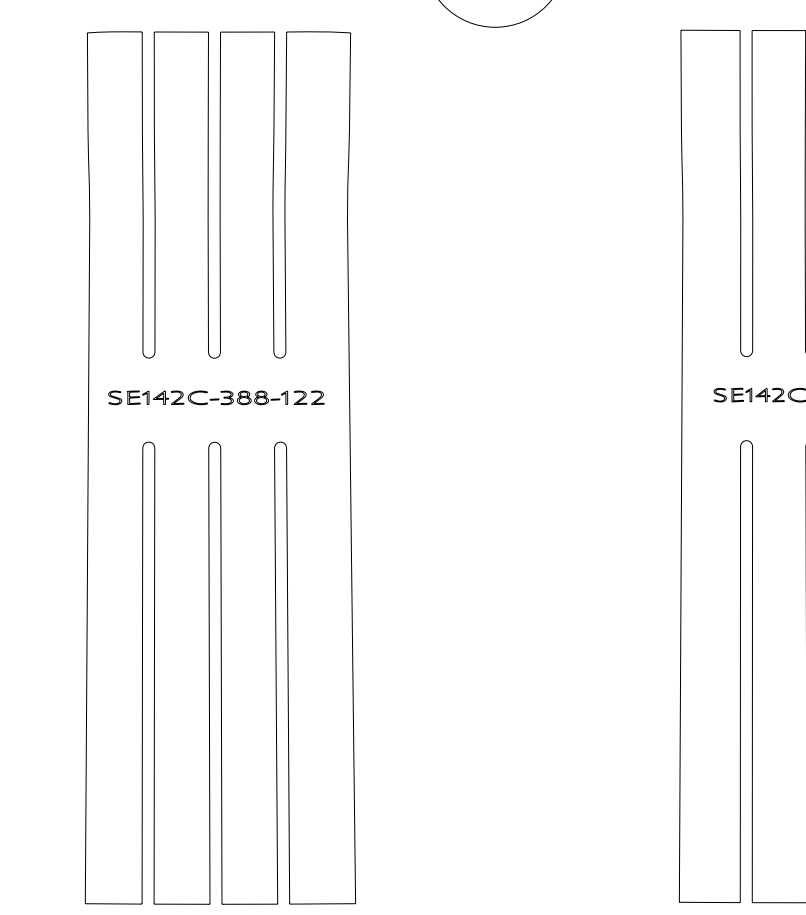

23

INSTANCE SE142C-388\_FLAT\_122  
INSTANCE SE142C-388\_FLAT\_123

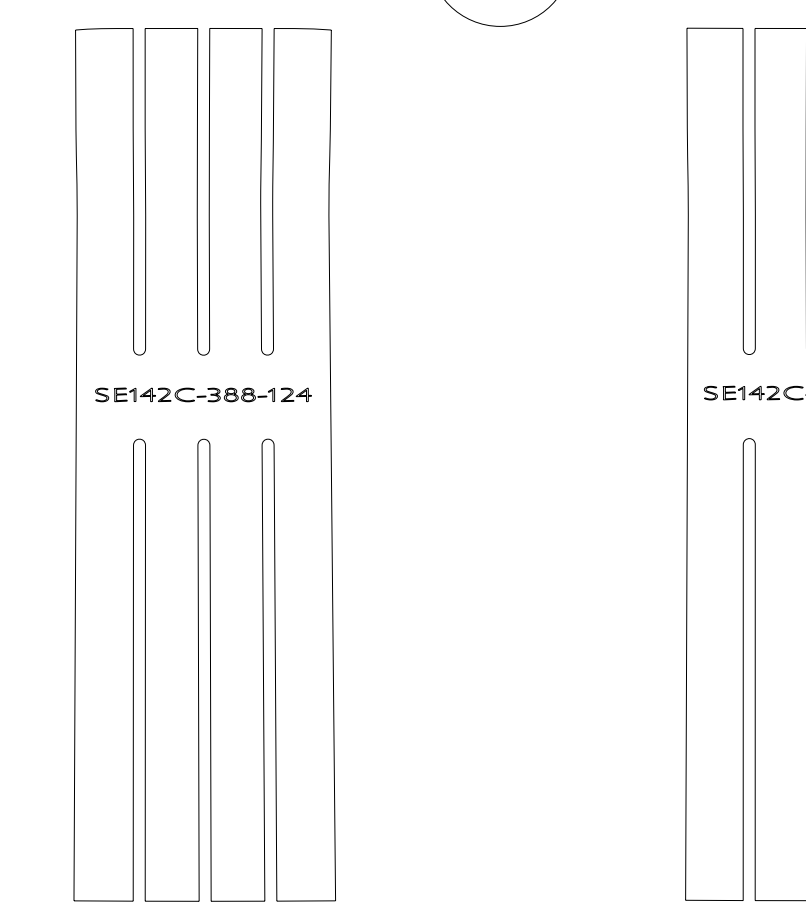

24

INSTANCE SE142C-388\_FLAT\_124  
INSTANCE SE142C-388\_FLAT\_125

RELEASED FOR FABRICATION / INSTALLATION  
PPPL Drafting

UT-BATTELLE						Oak Ridge National Laboratory managed for the DEPARTMENT OF ENERGY under U.S. GOVERNMENT CONTRACT DE-AC05-00OR22725 UT-BATTELLE, LLC. Oak Ridge, Tennessee					
NATIONAL COMPACT STELLARATOR EXPERIMENT											
MODULAR COIL TYPE - C											
SIDE "A" LOWER BOTTOM CHILL PLATE											
FLAT PATTERN LAYOUT											
VERSION NO.	PLANT	BLDG	FL	SHT	OF	TYPE	CLASS				
2	X-10	5700	3	2	5	S	U				
RELEASE LEVEL		SE142C-388									
Fabrication											



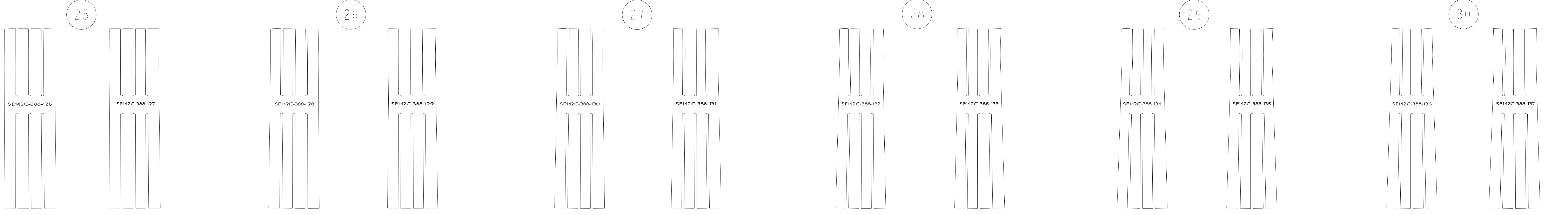

INSTANCE SE142C-388\_FLAT\_126 INSTANCE SE142C-388\_FLAT\_127  
INSTANCE SE142C-388\_FLAT\_128 INSTANCE SE142C-388\_FLAT\_129  
INSTANCE SE142C-388\_FLAT\_130 INSTANCE SE142C-388\_FLAT\_131  
INSTANCE SE142C-388\_FLAT\_132 INSTANCE SE142C-388\_FLAT\_133  
INSTANCE SE142C-388\_FLAT\_134 INSTANCE SE142C-388\_FLAT\_135  
INSTANCE SE142C-388\_FLAT\_136 INSTANCE SE142C-388\_FLAT\_137

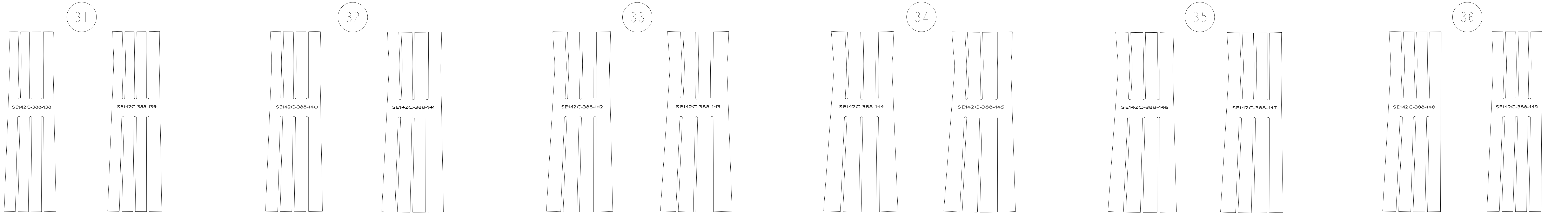

INSTANCE SE142C-388\_FLAT\_138 INSTANCE SE142C-388\_FLAT\_139  
INSTANCE SE142C-388\_FLAT\_140 INSTANCE SE142C-388\_FLAT\_141  
INSTANCE SE142C-388\_FLAT\_142 INSTANCE SE142C-388\_FLAT\_143  
INSTANCE SE142C-388\_FLAT\_144 INSTANCE SE142C-388\_FLAT\_145  
INSTANCE SE142C-388\_FLAT\_146 INSTANCE SE142C-388\_FLAT\_147  
INSTANCE SE142C-388\_FLAT\_148 INSTANCE SE142C-388\_FLAT\_149

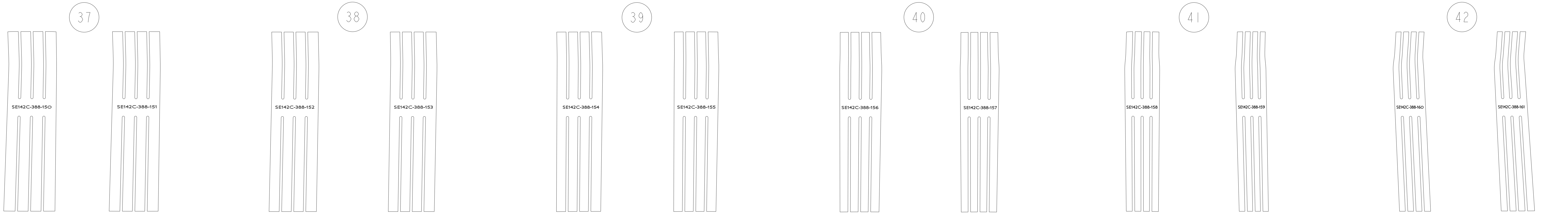

INSTANCE SE142C-388\_FLAT\_150 INSTANCE SE142C-388\_FLAT\_151  
INSTANCE SE142C-388\_FLAT\_152 INSTANCE SE142C-388\_FLAT\_153  
INSTANCE SE142C-388\_FLAT\_154 INSTANCE SE142C-388\_FLAT\_155  
INSTANCE SE142C-388\_FLAT\_156 INSTANCE SE142C-388\_FLAT\_157  
INSTANCE SE142C-388\_FLAT\_158 INSTANCE SE142C-388\_FLAT\_159  
INSTANCE SE142C-388\_FLAT\_160 INSTANCE SE142C-388\_FLAT\_161

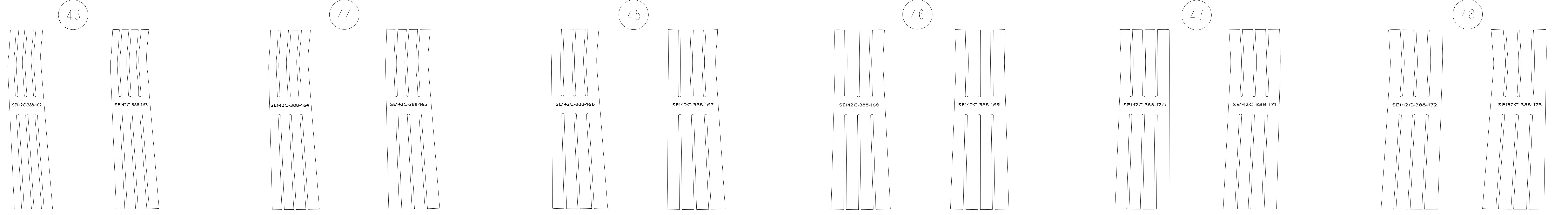

INSTANCE SE142C-388\_FLAT\_162 INSTANCE SE142C-388\_FLAT\_163  
INSTANCE SE142C-388\_FLAT\_164 INSTANCE SE142C-388\_FLAT\_165  
INSTANCE SE142C-388\_FLAT\_166 INSTANCE SE142C-388\_FLAT\_167  
INSTANCE SE142C-388\_FLAT\_168 INSTANCE SE142C-388\_FLAT\_169  
INSTANCE SE142C-388\_FLAT\_170 INSTANCE SE142C-388\_FLAT\_171  
INSTANCE SE142C-388\_FLAT\_172 INSTANCE SE142C-388\_FLAT\_173

**RELEASED FOR FABRICATION / INSTALLATION**  
PPPL Drafting:

Oak Ridge National Laboratory managed for the DEPARTMENT OF ENERGY under U.S. GOVERNMENT CONTRACT DE-AC05-00OR22725 UT-BATTELLE, LLC. Oak Ridge, Tennessee PROJECT NAME:									
<b>NATIONAL COMPACT STELLARATOR EXPERIMENT</b> MODULAR COIL TYPE - C SIDE "A" LOWER BOTTOM CHILL PLATE FLAT PATTERN LAYOUT									
VERSION NO.	PLANT	BLDG	FL	SHT	OF	TYPE	CLASS		
4	X-10	5700	3	3	5	S	U		
RELEASE LEVEL		SE142C-388							
Fabrication									





Oak Ridge National Laboratory managed for the DEPARTMENT OF ENERGY under U.S. GOVERNMENT CONTRACT DE-AC05-00OR22725 UT-BATTELLE, LLC. Oak Ridge, Tennessee PROJECT NAME									
<b>UT-BATTELLE</b> <b>NATIONAL COMPACT STELLARATOR EXPERIMENT</b> MODULAR COIL TYPE - C SIDE "A" LOWER BOTTOM CHILL PLATE FLAT PATTERN LAYOUT									
VERSION NO.	PLANT	BLDG	FL	SHT	OF	TYPE	CLASS		
1	X-10	5700	3	4	5	S	U		
RELEASE LEVEL		SE142C-388							
Fabrication									

**RELEASED FOR  
 FABRICATION / INSTALLATION**  
 PPPL Drafting:

SE142C-388



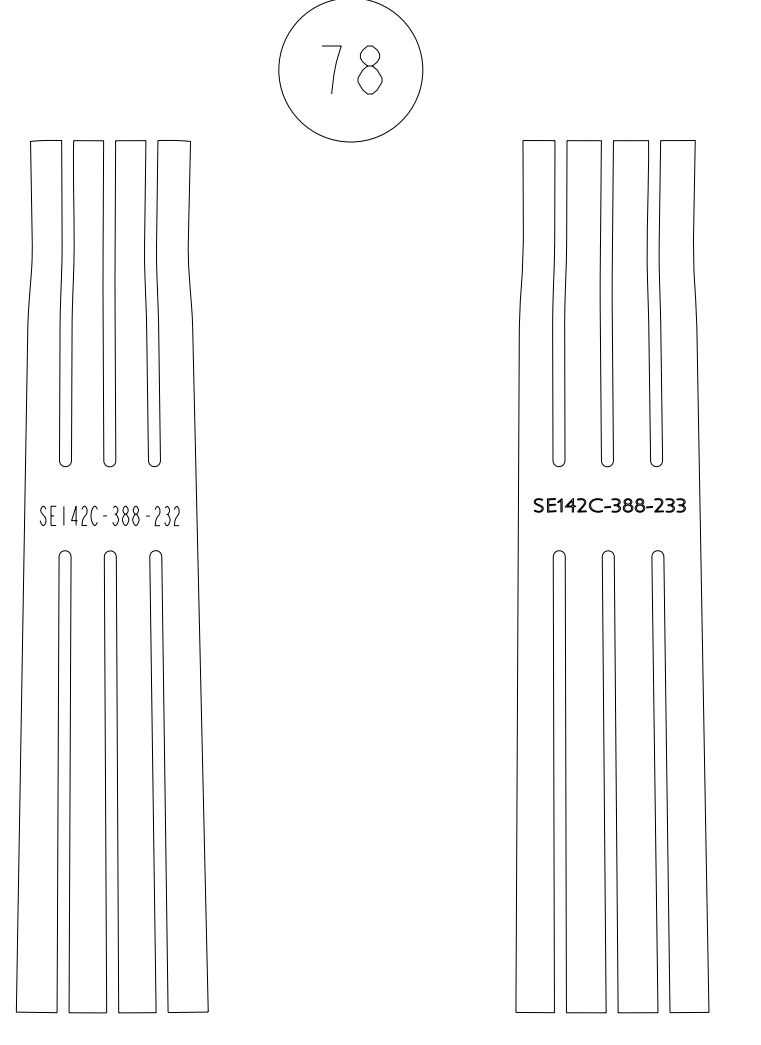

INSTANCE SEI42C-388\_FLAT\_232 INSTANCE SEI42C-388\_FLAT\_233

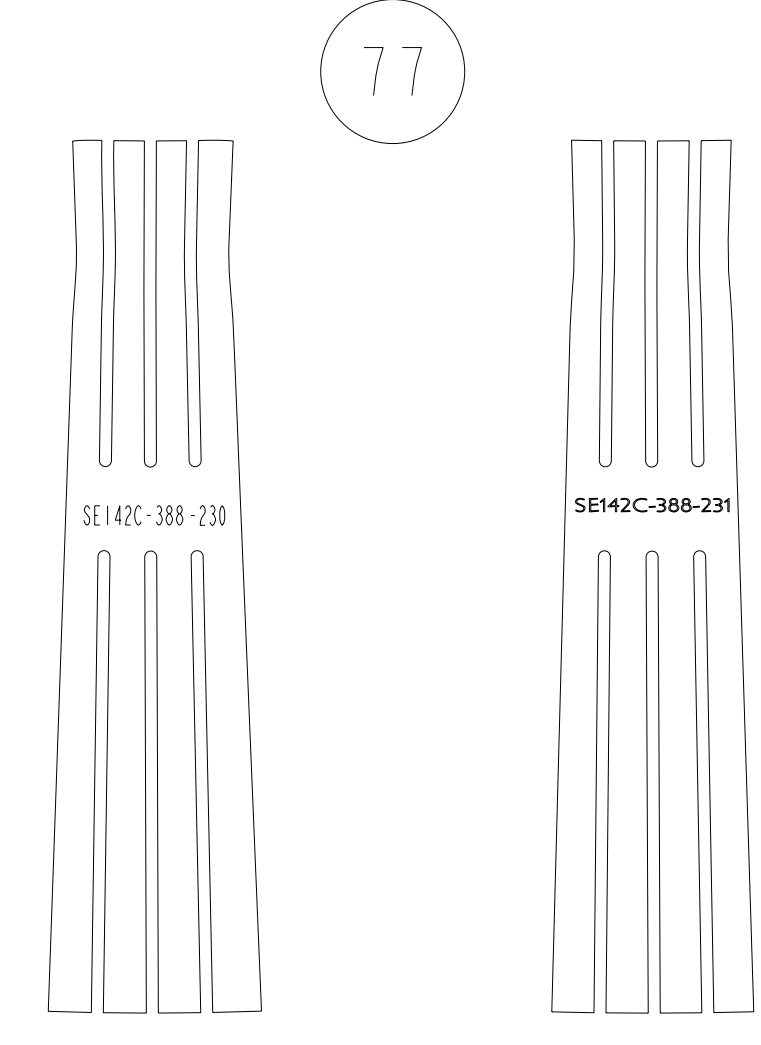

INSTANCE SEI42C-388\_FLAT\_230 INSTANCE SEI42C-388\_FLAT\_231

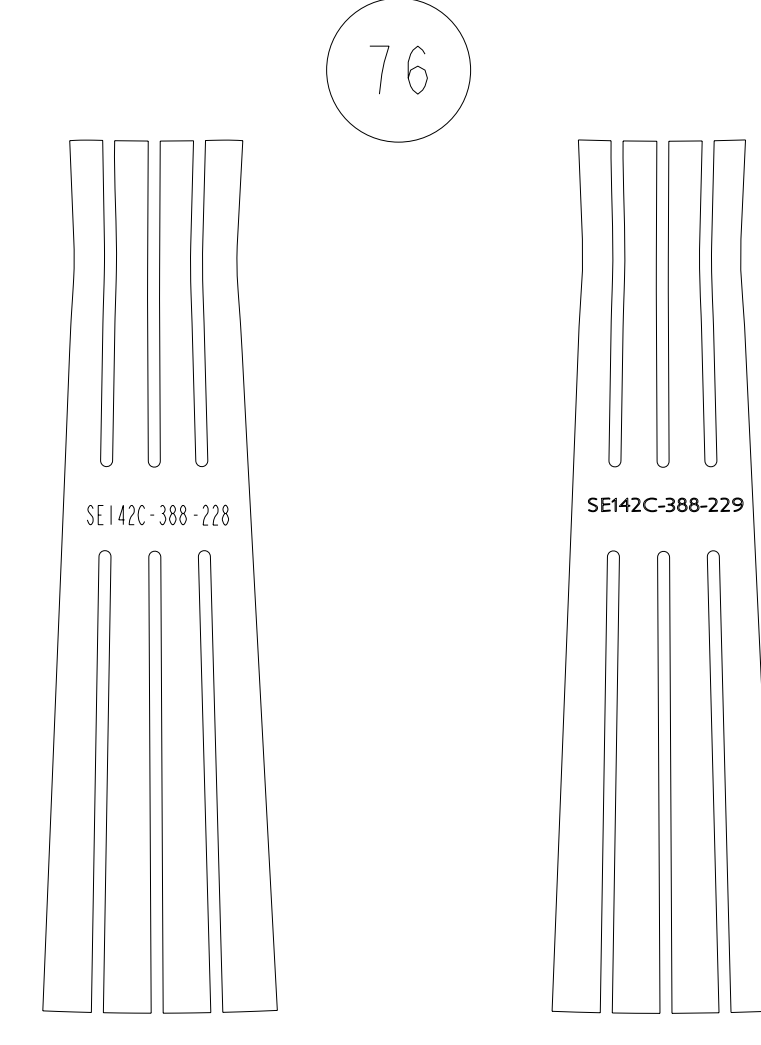

INSTANCE SEI42C-388\_FLAT\_228 INSTANCE SEI42C-388\_FLAT\_229

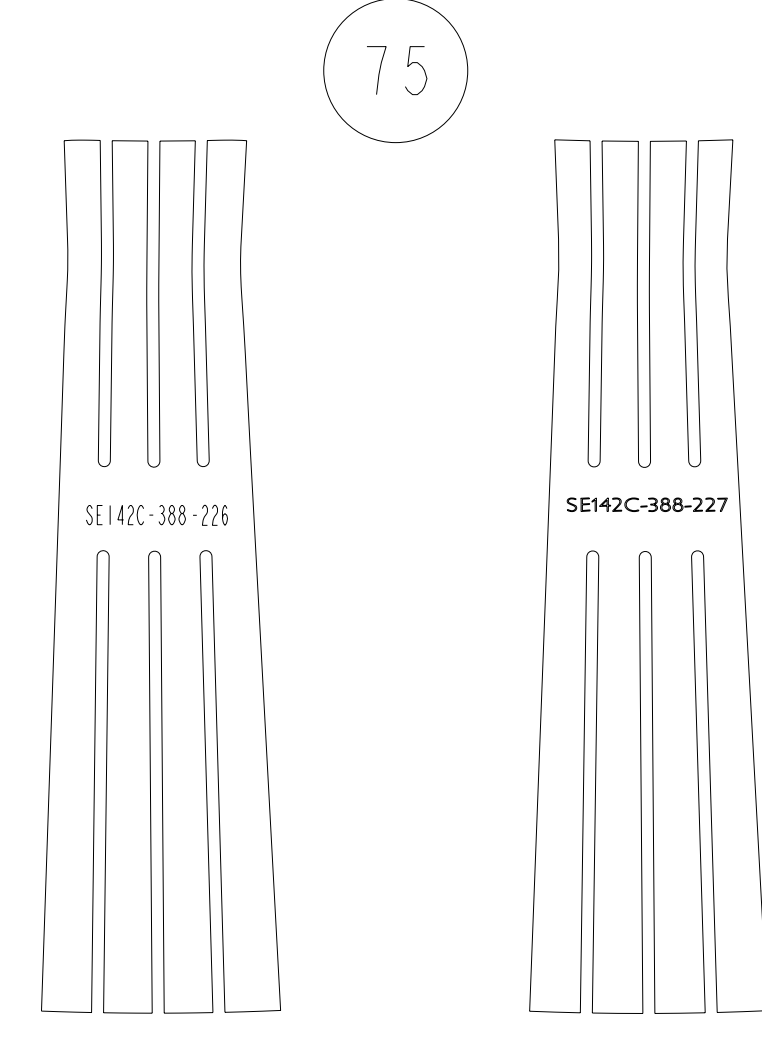

INSTANCE SEI42C-388\_FLAT\_226 INSTANCE SEI42C-388\_FLAT\_227

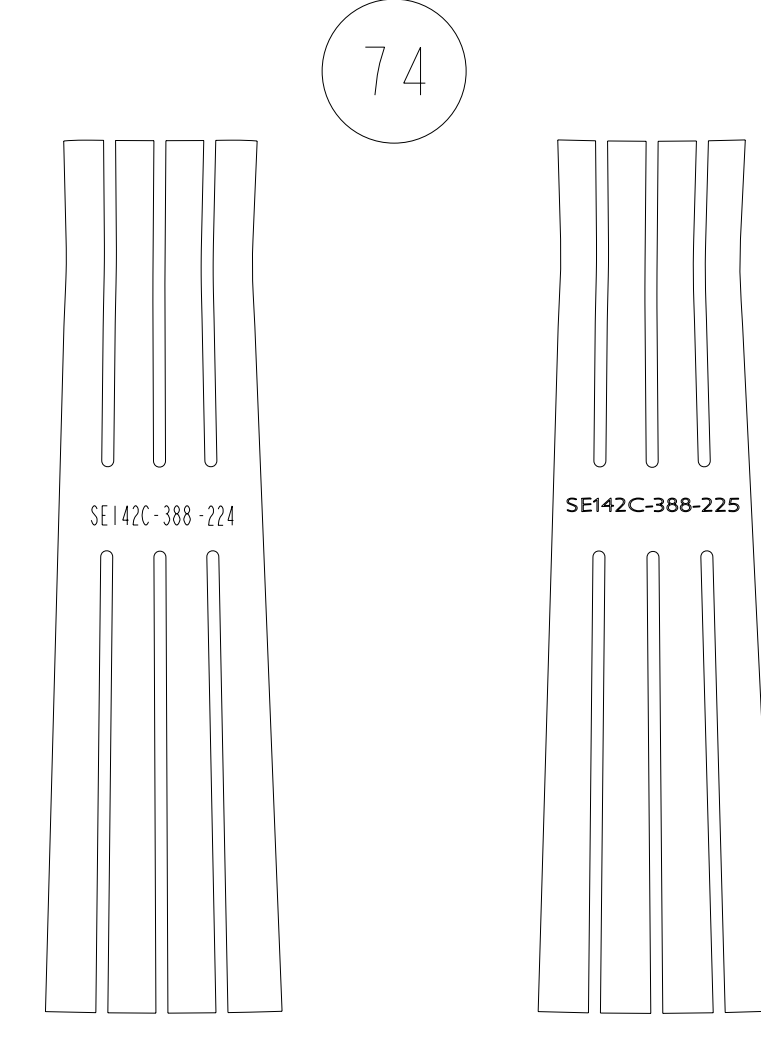

INSTANCE SEI42C-388\_FLAT\_224 INSTANCE SEI42C-388\_FLAT\_225

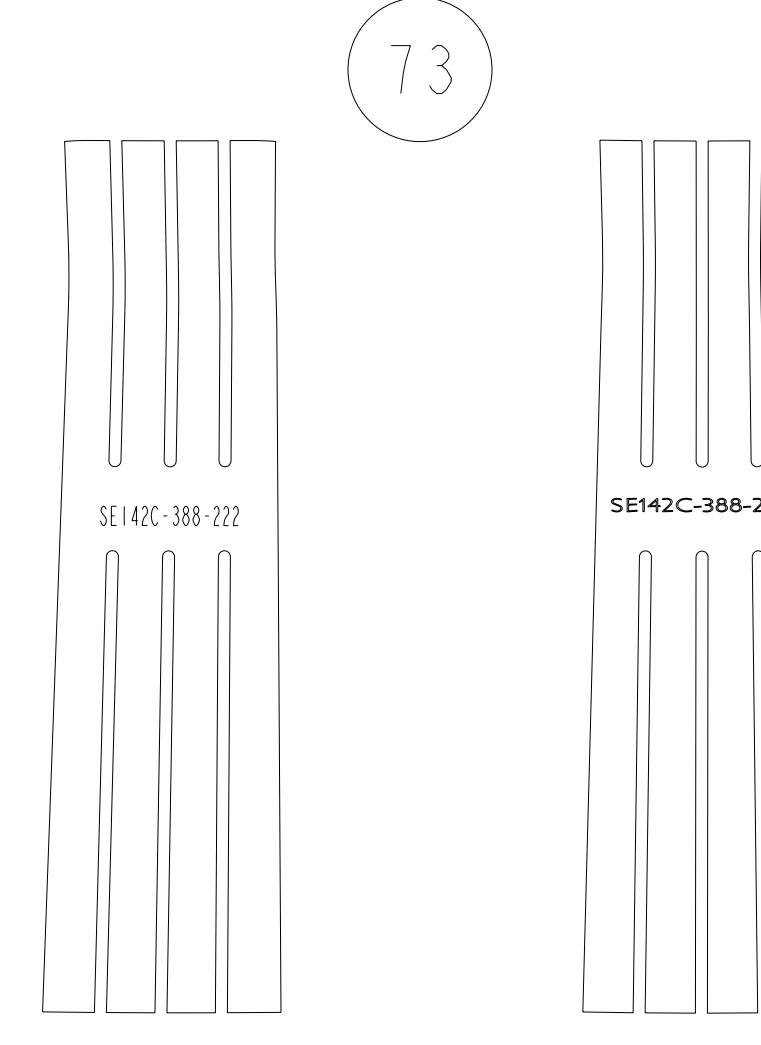

INSTANCE SEI42C-388\_FLAT\_222 INSTANCE SEI42C-388\_FLAT\_223

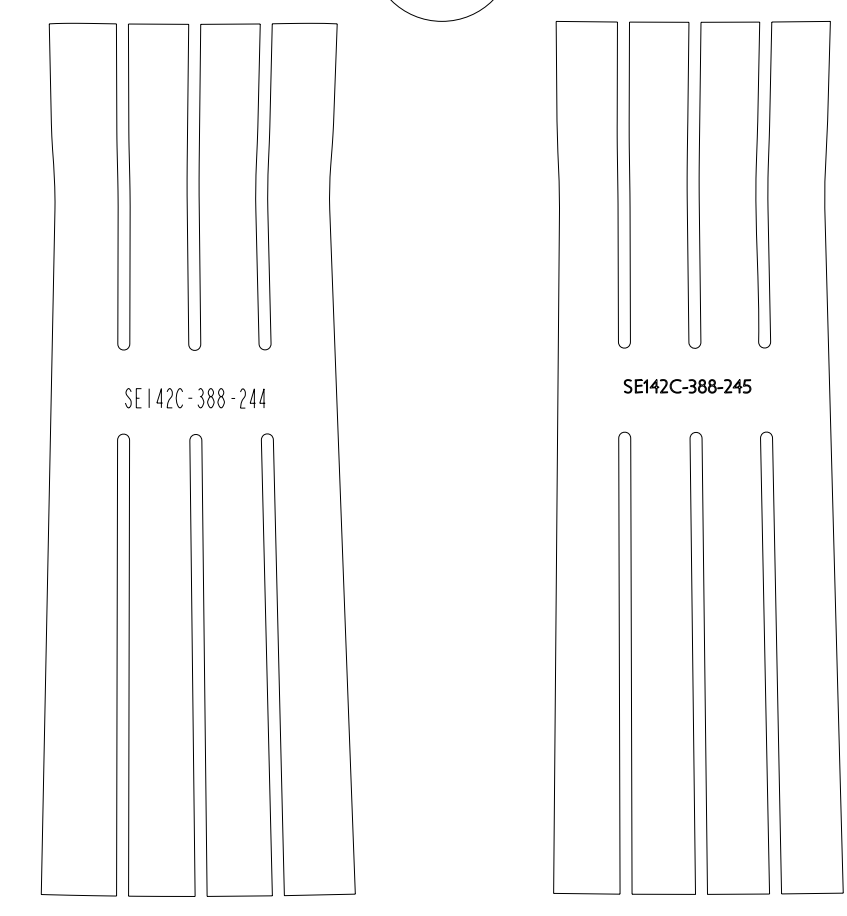

INSTANCE SEI42C-388\_FLAT\_244 INSTANCE SEI42C-388\_FLAT\_245

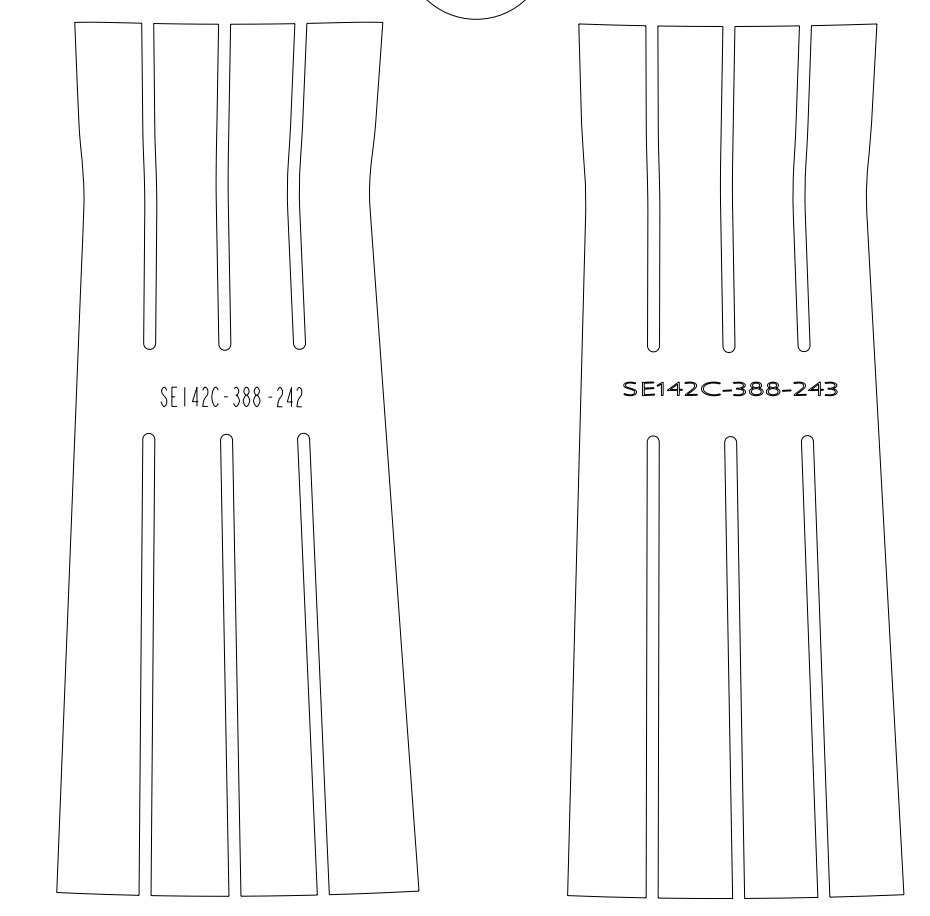

INSTANCE SEI42C-388\_FLAT\_242 INSTANCE SEI42C-388\_FLAT\_243

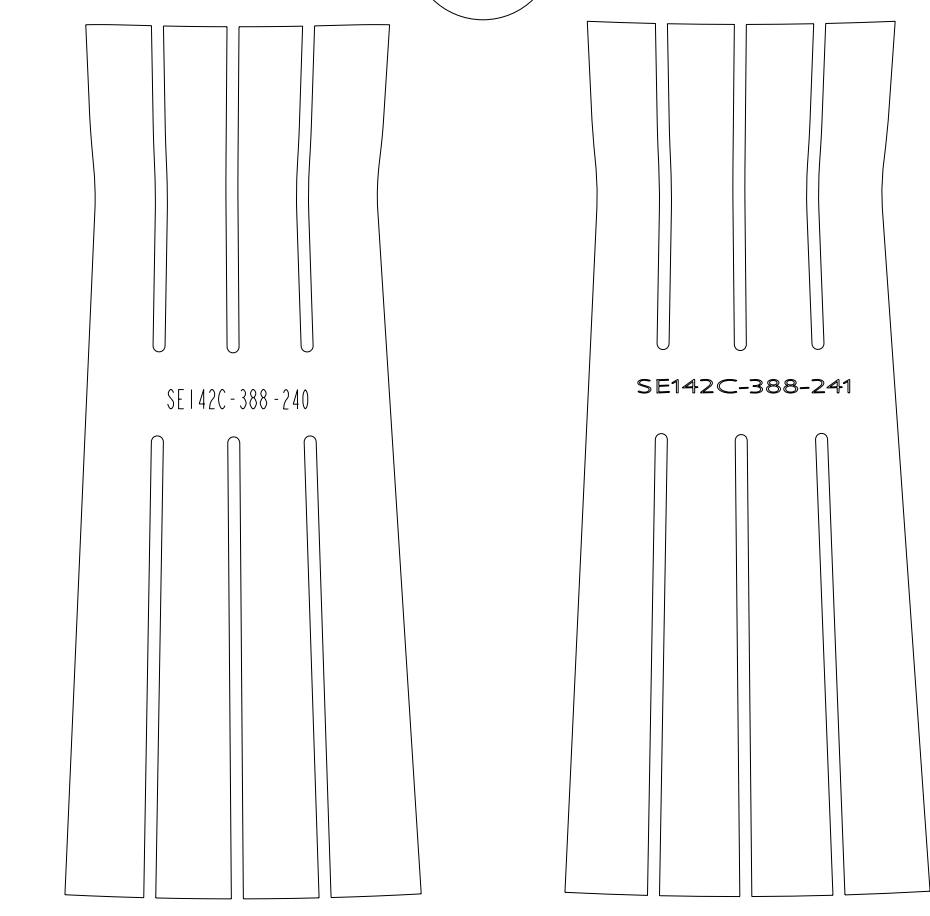

INSTANCE SEI42C-388\_FLAT\_240 INSTANCE SEI42C-388\_FLAT\_241

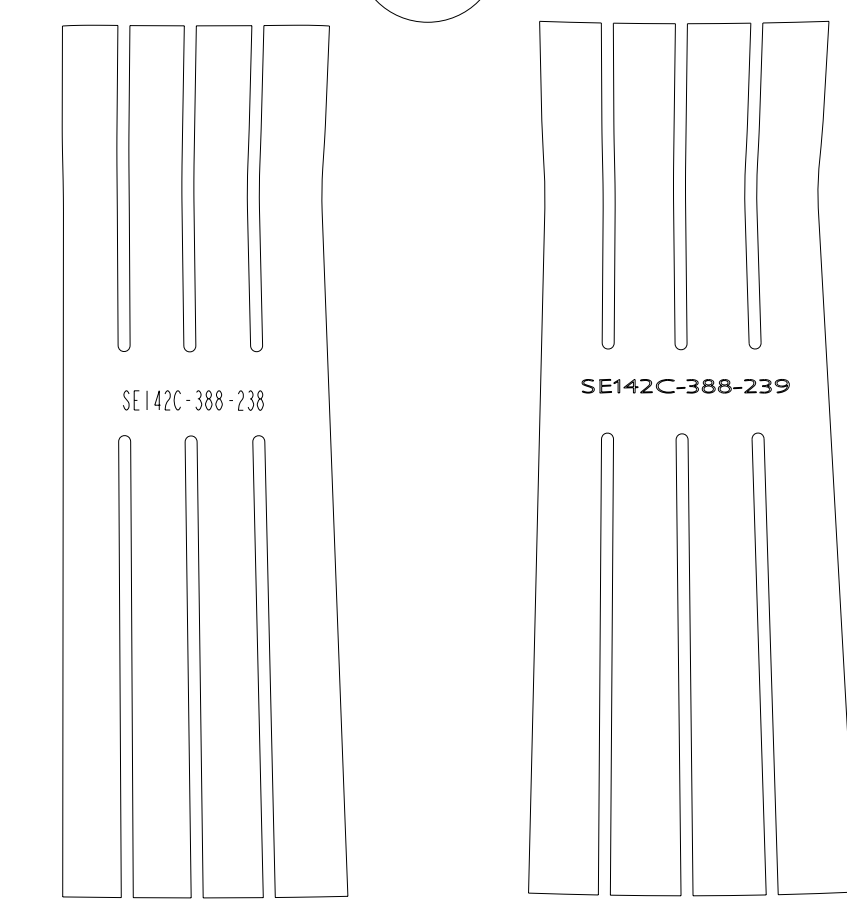

INSTANCE SEI42C-388\_FLAT\_238 INSTANCE SEI42C-388\_FLAT\_239

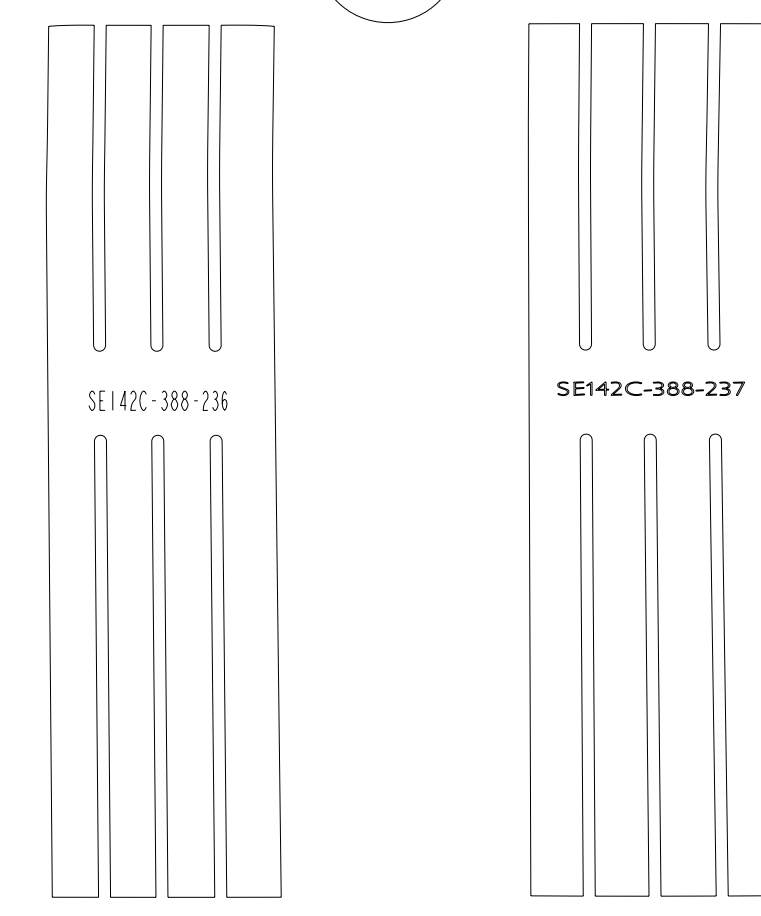

INSTANCE SEI42C-388\_FLAT\_236 INSTANCE SEI42C-388\_FLAT\_237

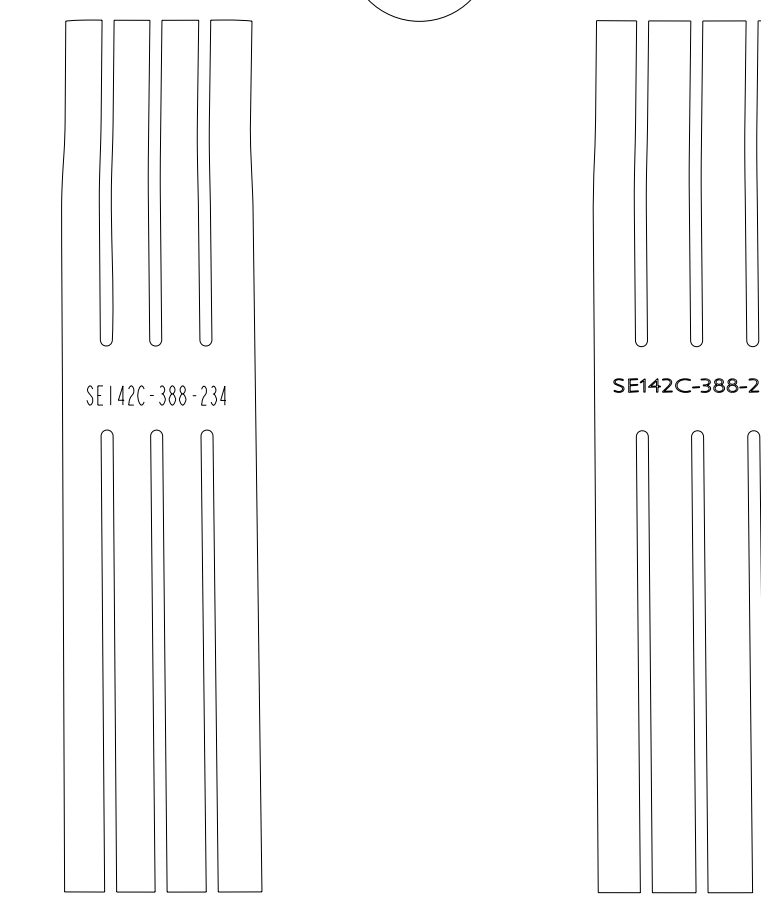

INSTANCE SEI42C-388\_FLAT\_234 INSTANCE SEI42C-388\_FLAT\_235

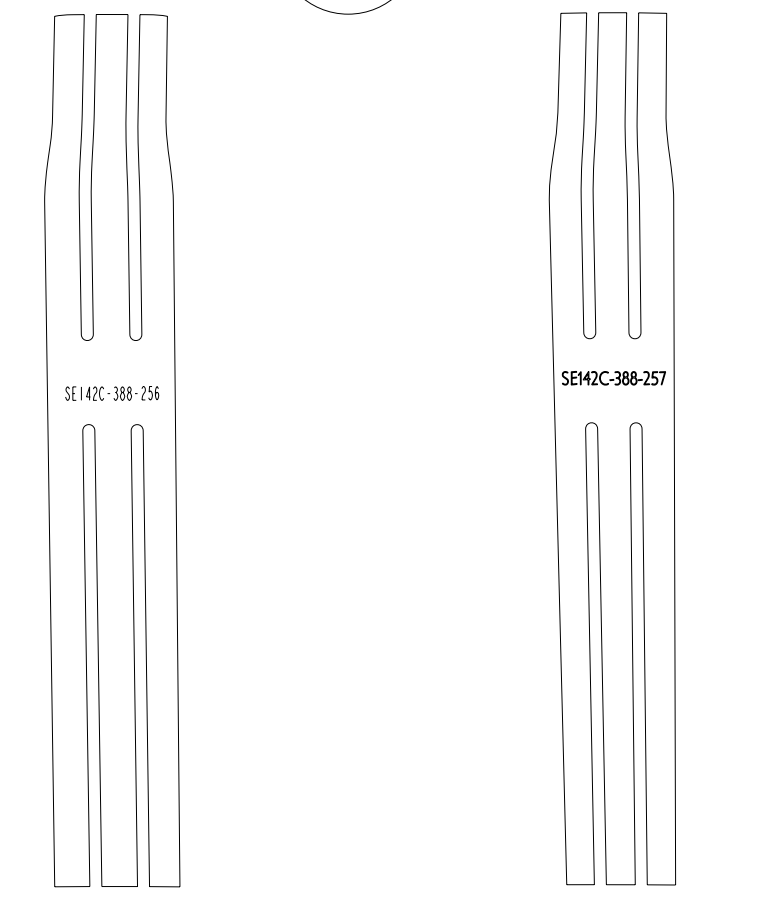

INSTANCE SEI42C-388\_FLAT\_NEW\_256 INSTANCE SEI42C-388\_FLAT\_NEW\_257

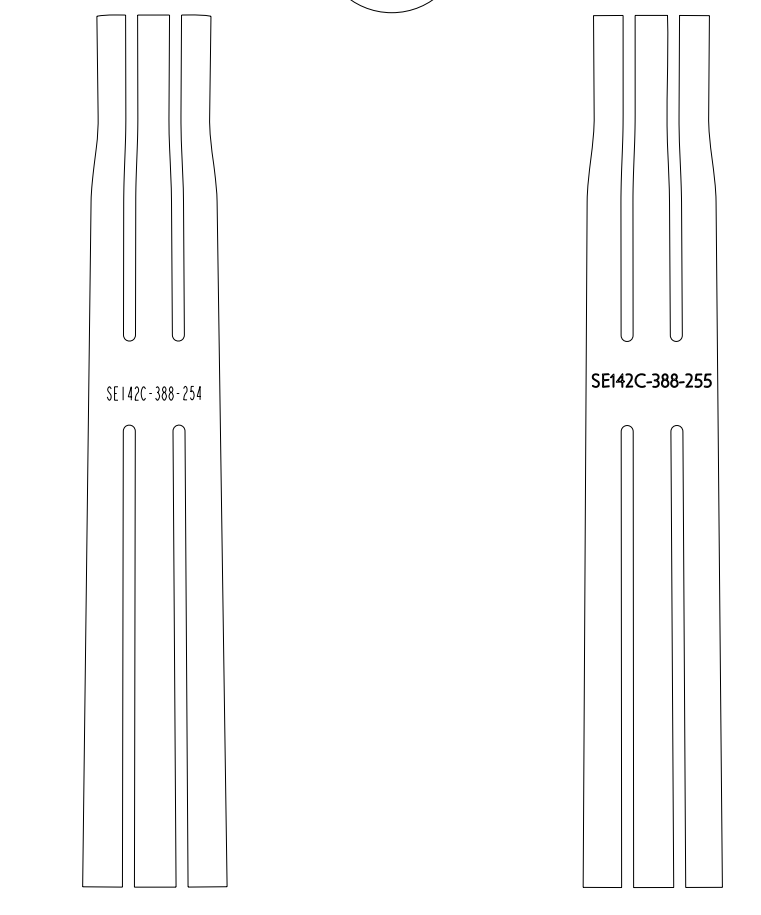

INSTANCE SEI42C-388\_FLAT\_NEW\_254 INSTANCE SEI42C-388\_FLAT\_NEW\_255

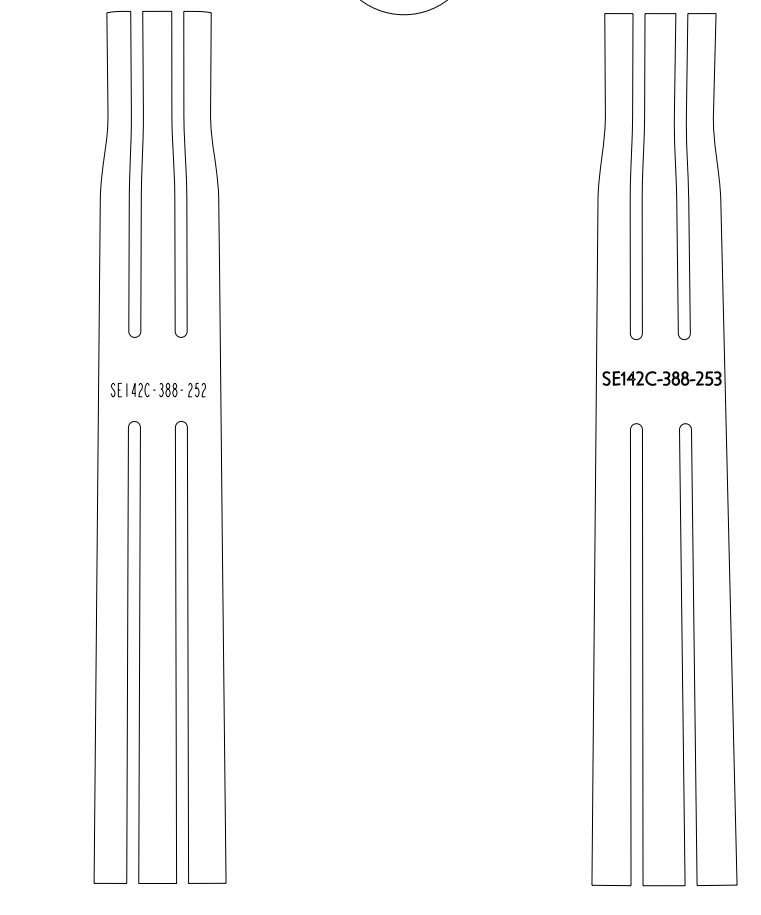

INSTANCE SEI42C-388\_FLAT\_NEW\_252 INSTANCE SEI42C-388\_FLAT\_NEW\_253

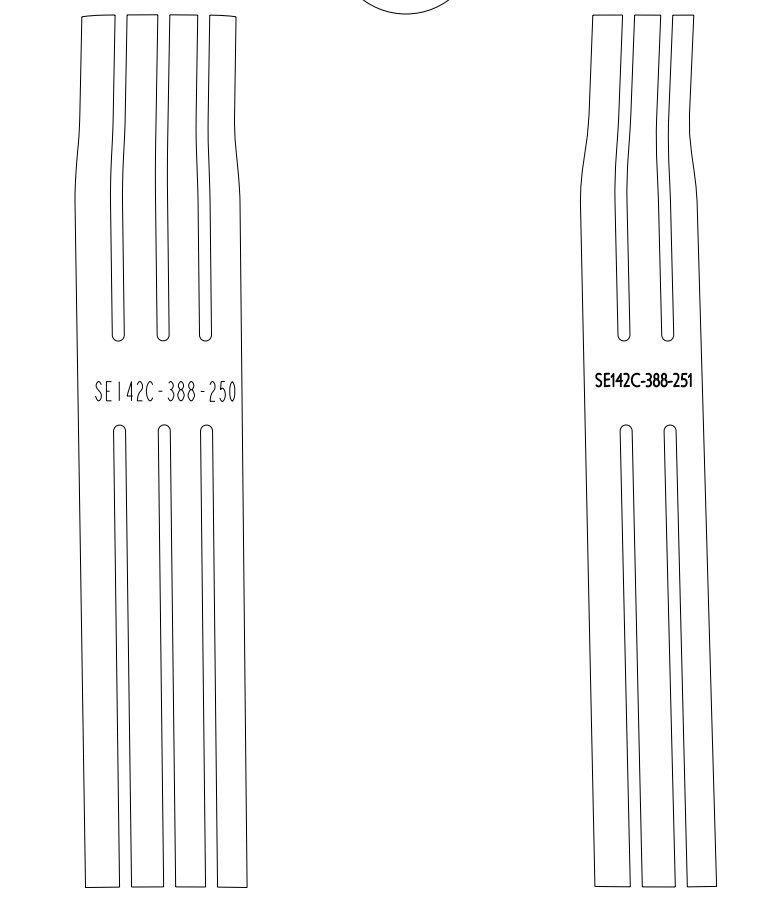

INSTANCE SEI42C-388\_FLAT\_250 INSTANCE SEI42C-388\_FLAT\_NEW\_251

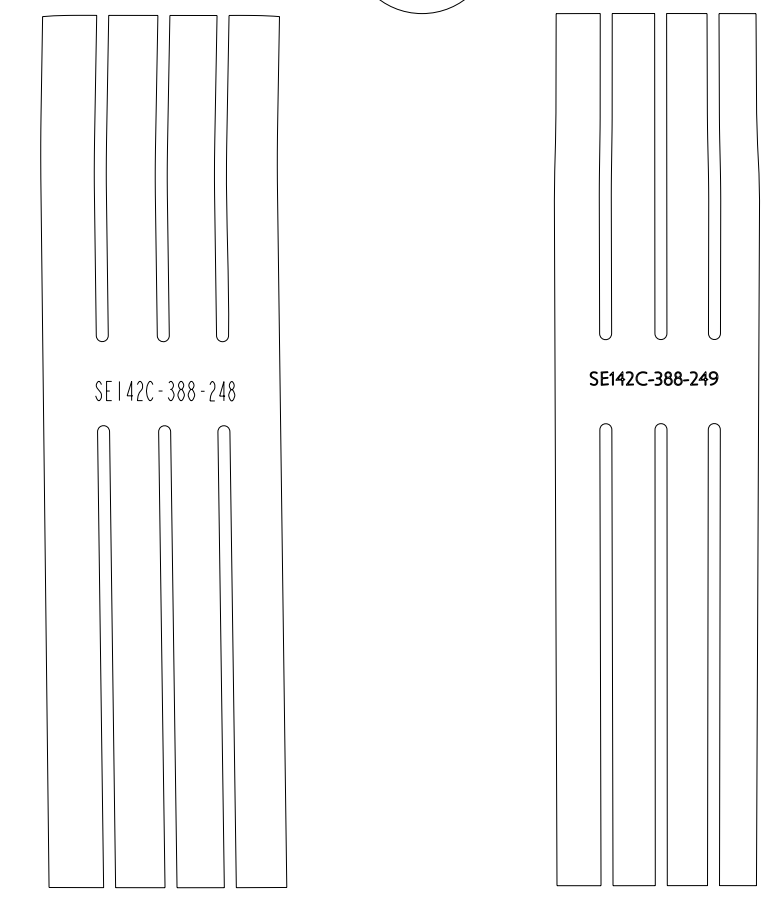

INSTANCE SEI42C-388\_FLAT\_248 INSTANCE SEI42C-388\_FLAT\_249

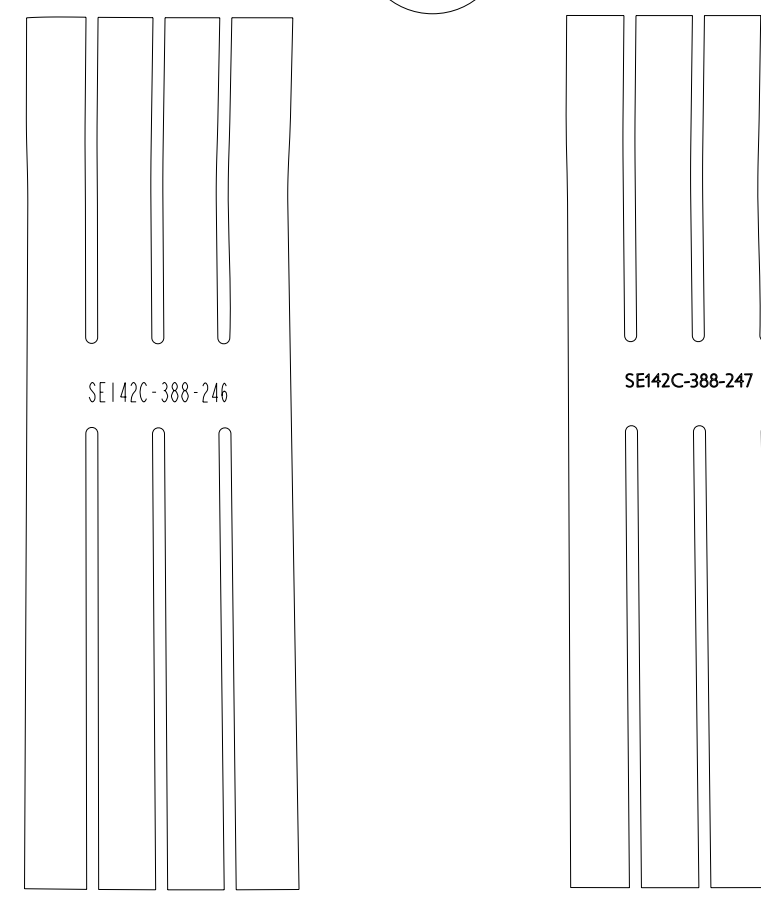

INSTANCE SEI42C-388\_FLAT\_246 INSTANCE SEI42C-388\_FLAT\_247

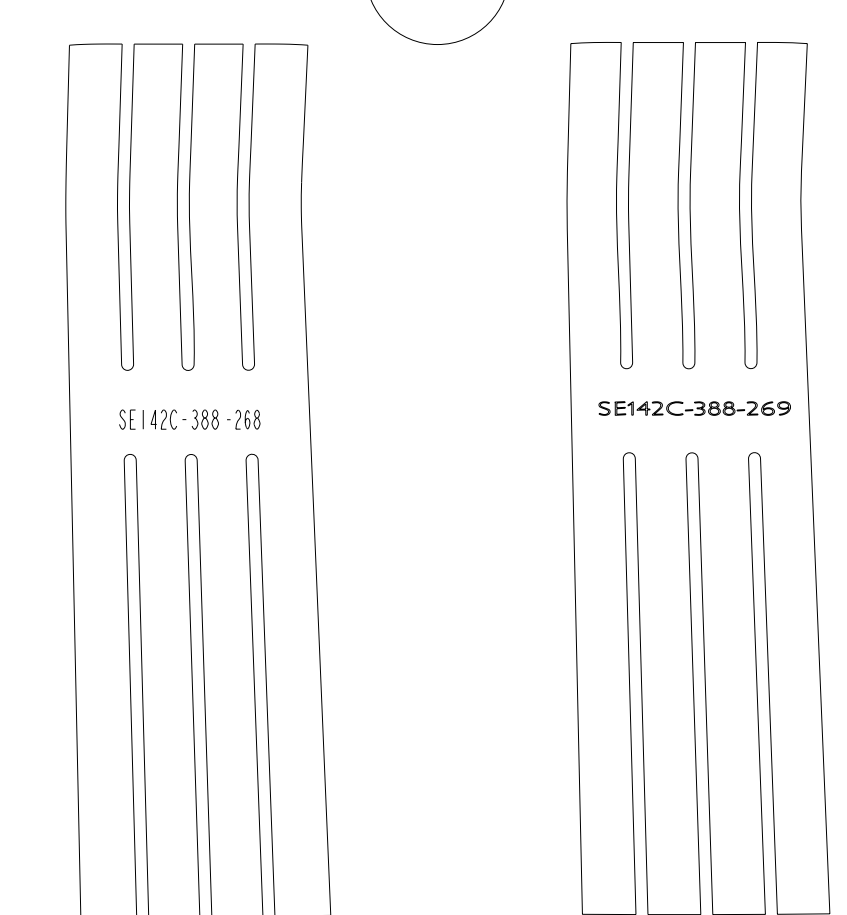

INSTANCE SEI42C-388\_FLAT\_268 INSTANCE SEI42C-388\_FLAT\_269

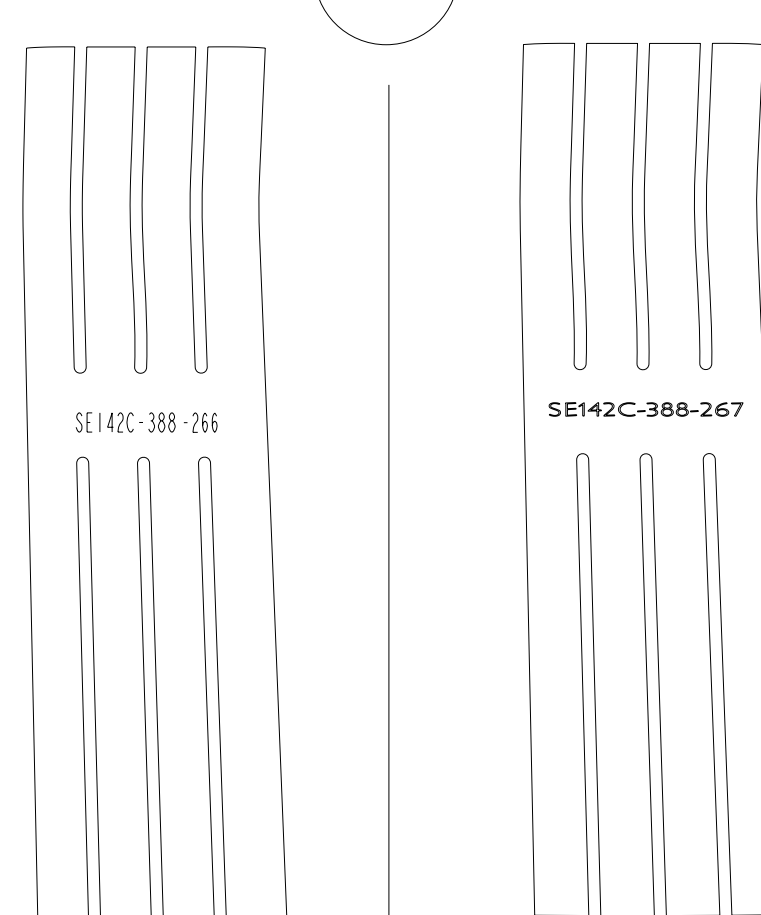

INSTANCE SEI42C-388\_FLAT\_266 INSTANCE SEI42C-388\_FLAT\_267

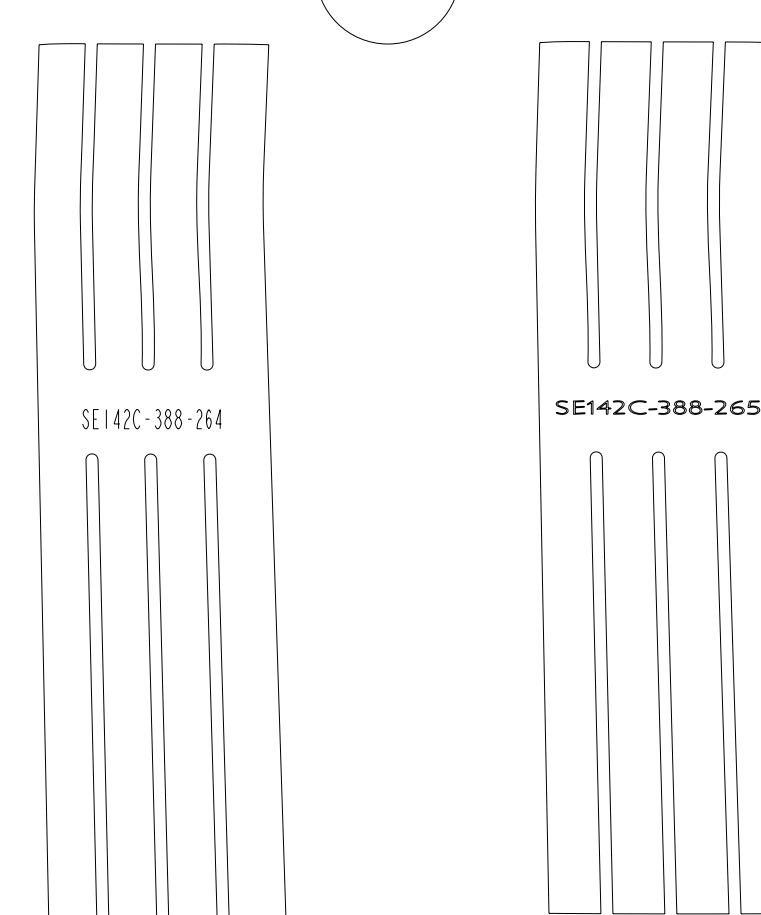

INSTANCE SEI42C-388\_FLAT\_264 INSTANCE SEI42C-388\_FLAT\_265

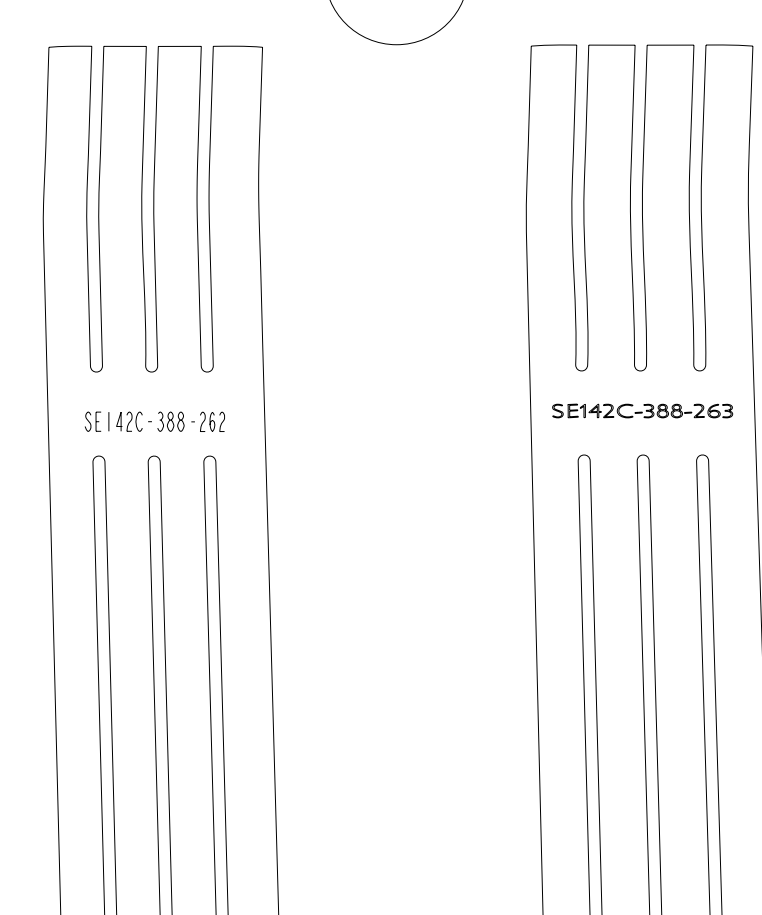

INSTANCE SEI42C-388\_FLAT\_262 INSTANCE SEI42C-388\_FLAT\_263

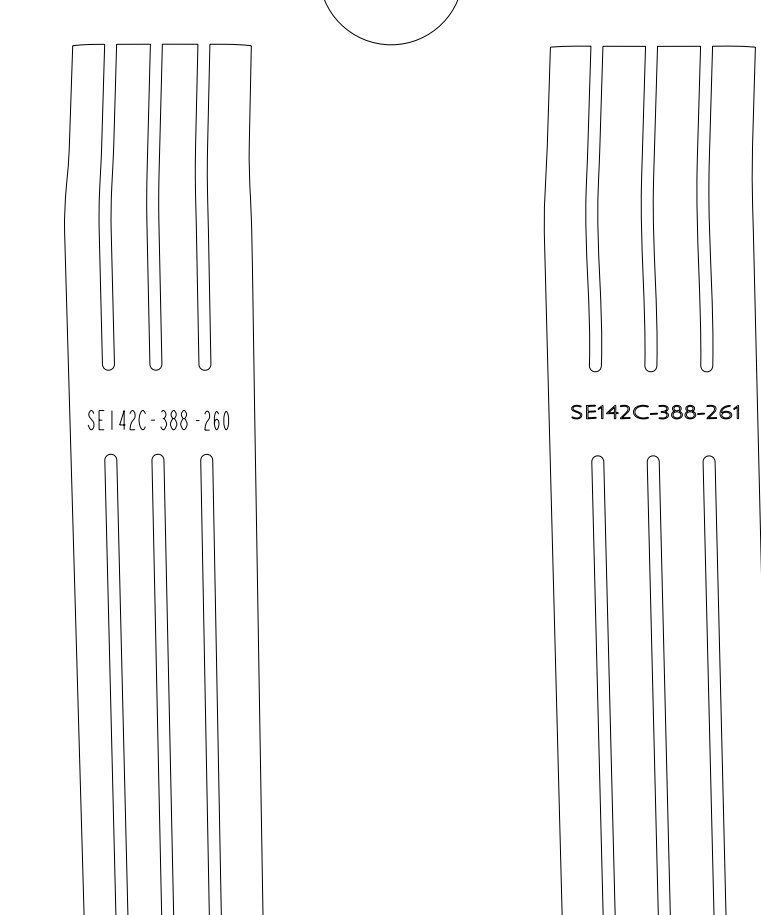

INSTANCE SEI42C-388\_FLAT\_260 INSTANCE SEI42C-388\_FLAT\_261

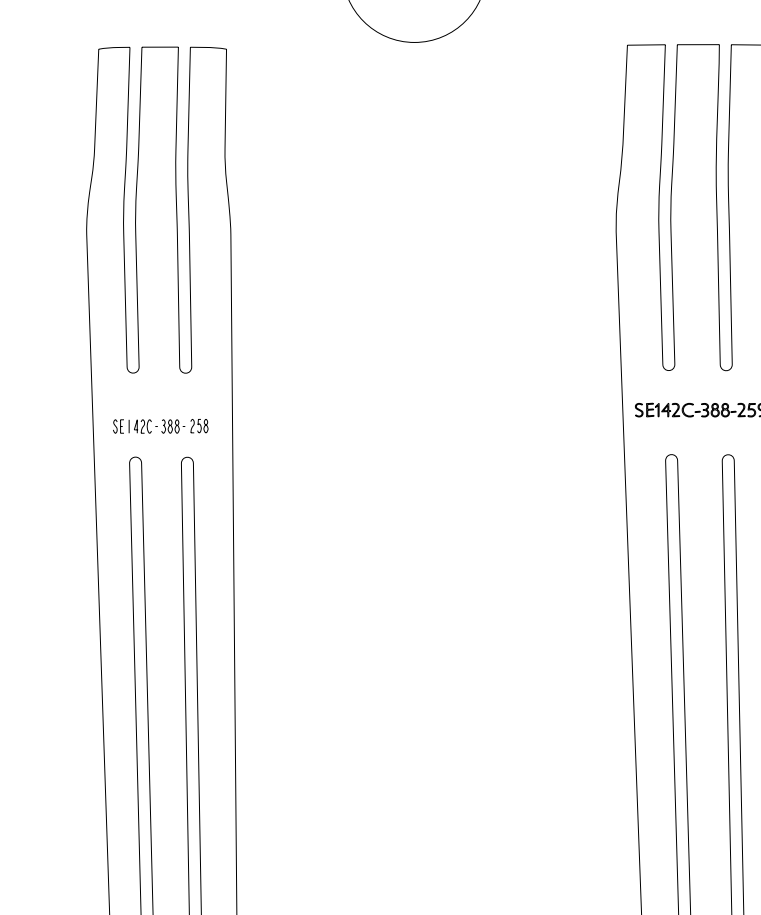

INSTANCE SEI42C-388\_FLAT\_NEW\_258 INSTANCE SEI42C-388\_FLAT\_NEW\_259

2 THESE PARTS TO BE NEMA GRADE G11CR MATERIAL

RELEASED FOR FABRICATION / INSTALLATION PPPL Drafting:

UT-BATTELLE										Oak Ridge National Laboratory managed for the DEPARTMENT OF ENERGY under U.S. GOVERNMENT CONTRACT DE-AC05-00OR22725 UT-BATTELLE, LLC. Oak Ridge, Tennessee									
NATIONAL COMPACT STELLARATOR EXPERIMENT										PROJECT NAME									
MODULAR COIL TYPE - C										SIDE "A" LOWER BOTTOM CHILL PLATE									
FLAT PATTERN LAYOUT										CLASS									
VERSION NO.	PLANT	BLDG	FL	SHT	OF	TYPE	CLASS	REV	DATE	BY	CHKD	DATE	BY	CHKD	DATE	BY	CHKD	DATE	BY
4	X-10	5700	3	5	5	S	U	2											
RELEASE LEVEL Fabrication										SEI42C-388									

SEI42C-388