

**PROJECT CLOSEOUT REPORT
NATIONAL COMPACT STELLARATOR
EXPERIMENT (NCSX)**

AUGUST 2009

**Prepared for the U.S. Department of Energy
Office of Science**

**Princeton Plasma Physics Laboratory
Oak Ridge National Laboratory**

**PROJECT CLOSEOUT REPORT
NATIONAL COMPACT STELLARATOR EXPERIMENT
(NCSX)**

AUGUST 2009

Prepared by Donald J. Rej &
Ronald L. Strykowski

NCSX Project Managers
Princeton Plasma Physics Laboratory

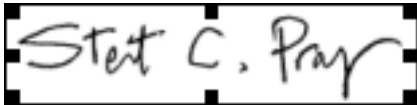

Submitted by Stewart Prager
Director
Princeton Plasma Physics Laboratory

Approved by Jeffrey Makiel
DOE Federal Project Director for the
National Compact Stellarator Experiment

CONTENTS

ACRONYMS	vi
EXECUTIVE SUMMARY.....	viii
1. INTRODUCTION	1
2. PROJECT PURPOSE & SCOPE.....	1
3. PROJECT HISTORY	4
4. PROJECT DESCRIPTION & STATUS AT CLOSEOUT.....	5
4.1 Stellarator Core.....	5
Vacuum Vessel System (WBS 12)	5
Conventional Coils (WBS 13)	9
Modular Coils (WBS 14)	11
Conventional Coil Structures (WBS 15)	19
Coil Services (WBS 16)	19
Cryostat & Base Structure (WBS 17).....	21
Field Period Assembly (WBS 18)	24
4.2 Auxiliary Systems (WBS 2)	28
4.3 Diagnostics (WBS 3).....	29
4.4 Electrical Power Systems (WBS 4).....	30
4.5 Central Instrumentation, Controls, & Data Acquisition (WBS 5)	30
4.6 Facility Systems (WBS 6).....	31
4.7 Test Cell Preparation & Machine Assembly (WBS 7)	32
4.8 Technical Management & Support.....	34
Project Physics	34
Project Engineering.....	35
System Engineering	35
Design Integration.....	35
System analysis / Technical Assurance	36

Dimensional Control Coordination.....	36
Plant Design	36
Integrated System Testing.....	36
Closeout Documentation.....	36
Equipment Disposition	37
5. PROJECT MANAGEMENT	37
6. COST & SCHEDULE PERFORMANCE.....	39
6.1 Cost & Schedule of Work Accomplished.....	39
6.2 Cost & Schedule Estimates to Complete Unfinished Work	41
6.3 Final Estimate at Completion	42
7. ENVIRONMENT, SAFETY, & HEALTH	44
8. KEY LESSONS LEARNED.....	45
8.1 DOE Perspective.....	45
8.2 Contractor Perspective	47
Underlying Issues.....	47
Lessons learned.....	48
9. REFERENCE DOCUMENTS	53
APPENDICES:.....	55
A. NCSX MIE PROJECT CHRONOLOGY.....	55
B. 2005 BASELINE PROJECT PERFORMANCE OBJECTIVES	58
C. FINAL COSTS	60
D. FUNDING & BUDGET.....	62
E. COST ESTIMATE HISTORY.....	64
F. BASELINE CHANGE CONTROL LOG	67
G. RISK MANAGEMENT.....	71
H. CONTINGENCY USE.....	75

I. MAJOR PROCUREMENTS	76
J. STAFFING.....	77
K. MAJOR EXTERNAL NCSX PROJECT REVIEWS	78
L. MAJOR EQUIPMENT INVENTORY	80
M. DATA ARCHIVING.....	88
N. PUBLICATION of NCSX ACCOMPLISHMENTS	89
O. ENGINEERING CHANGE PROPOSAL (ECP-60): PROJECT CLOSEOUT...	92
P. PROJECT TERMINATION & CLOSEOUT COMPLETION DOCUMENTATION	93

ACRONYMS

ACC	activity certification committee
BCP	baseline change proposal
CAD	Computer-Aided Design
CCD	charged-coupled device
CD	DOE Critical Decision
CDR	Conceptual Design Report
CERN	European Organization for Nuclear Research, Geneva
CS	central solenoid
DOE	U.S. Department of Energy
ECN	engineering change notices
ECP	engineering change proposal
ESAAB	DOE Energy Systems Acquisition Advisory Board
ES&H	environment, safety, and health
ES&H/EB	PPPL ES&H Executive Board
EPICS	experimental physics and industrial control system
FESAC	DOE Fusion Energy Science Advisory Committee
FDR	final design report
FPA	field period assembly
GPP	general plant project
GRD	general requirements document
HPA	half (field) period assembly
I&C	instruments and controls
ISM	integrated safety management
ITER	International Thermonuclear Experimental Reactor
LHC	Large Hadron Collider
LN2	Liquid Nitrogen
MCWF	modular coil winding form
MIE	major item of equipment
MIG	metal inert gas welding
MHD	magnetohydrodynamic
NCR	nonconformance report
NCSX	National Compact Stellarator Experiment
NEPA	National Environmental Policy Act
NSTX	PPPL National Spherical Torus Experiment
OECM	DOE Office of Engineering & Construction Management

OFES	DOE Office of Fusion Energy Research
ORNL	Oak Ridge National Laboratory
P&ID	process & instrumentation diagram
PDR	Preliminary Design Report
PEP	project execution plan
PF	poloidal field
PPPL	Princeton Plasma Physics Laboratory
PU	Princeton University
QA	quality assurance
QC	quality control
RFD	requests for deviations
RLM	responsible line manager
SC	DOE Office of Science
SRD	systems requirements document
TEC	total estimated cost
TF	toroidal field
TIG	Tungsten inert gas welding
TPC	total project cost
W7-X	Wendelstein 7X Stellarator, Max Planck Inst., Greifswald
WAF	work authorization form
WBS	work breakdown structure
VPI	vacuum-pressure impregnation
VVSA	vacuum vessel sub-assemblies

EXECUTIVE SUMMARY

The National Compact Stellarator Experiment (NCSX) Facility was a Major Item of Equipment under construction at the U.S. Department of Energy (DOE) Princeton Plasma Physics Laboratory in partnership with the Oak Ridge National Laboratory. The construction project was performed under the auspices of the DOE Office of Science, Office of Fusion Energy Sciences. NCSX was planned as the centerpiece of the U.S. stellarator program, providing a proof-of-principle demonstration of the compact, quasi-axisymmetric stellarator configuration. Flexibility and accurate realization of its complex three-dimensional geometry were key requirements affecting the design and construction. Design began in 2002, and construction started in 2004. In late 2006 it became clear that the baseline cost and schedule objectives could not be met, and following several reviews, the DOE concluded that the budget increases, schedule delays, and continuing uncertainties of the NCSX construction project necessitated its closure. At the time of project termination, the overall project was approximately 62% complete after expending 93% of the \$92M baseline capital budget. There were significant engineering accomplishments in design, fabrication, and assembly. The design of the stellarator core device was completed. All of the modular coils, toroidal field coils, and vacuum vessel sectors were fabricated. Critical assembly steps were demonstrated. Engineering advances were made in the application of computer-aided design modeling, structural analysis, metrology, welding, and accurate fabrication of complex-shaped components and sub-assemblies. Engineering designs, analyses and specifications, procurement packages, and fabricated sub-assemblies, were stored and archived, to allow revisiting this particular design if future developments in the fusion program warrant it. The cost to complete the project with contingency is estimated at \$73.3M in current year dollars (i.e. escalated) and 55 months (including schedule contingency). Both cost and schedule projections were based upon a 2/1/09 resumption of work. A lessons learned study was conducted to better understand issues that led to cost overruns and schedule delays, and to establish corrective actions to prevent reoccurrence of similar problems in future projects. Underlying issues included the premature establishment of cost and schedule baselines (that set initial expectations), an under-appreciation of technical risk, and inadequate staffing, oversight, and communication. Key project management lessons learned included the need for more upfront design and R&D, and improved risk management, cost and schedule estimating, external peer review, and communication. By the time of project cancellation, action plans to address these lessons learned were in place and implemented.

1. INTRODUCTION

The compact stellarator is one of several innovative magnetic fusion plasma configurations being investigated by the U.S. Department of Energy (DOE) Office of Science (SC), Office of Fusion Energy Sciences (OFES). The promise of the stellarator as a practical fusion concept lies in its potential to eliminate disruptions and operate steady-state with minimal recirculating power. Due to its geometry, a stellarator can generate significant rotational transform by currents in external magnet coils and can stabilize limiting magnetohydrodynamic (MHD) instabilities by plasma shaping instead of relying on active feedback control. Compact stellarators have aspect ratios much lower than previously optimized stellarator designs, thereby providing the further advantage of higher power density for reduced cost. When extrapolated to a fusion power plant, the compact stellarator is projected to require low operating power compared with that produced by the power plant. Though three-dimensional in their physical geometry, stellarators can be designed with an approximate symmetry direction in the magnetic field (*i.e.*, with quasi-axisymmetry) which gives them important physics similarities with tokamaks. This feature allows quasi-axisymmetric stellarators to make use of, and to contribute to, future tokamak scientific and technical advances, *e.g.*, in burning plasma research and development on the International Thermonuclear Experimental Reactor (ITER). In order to evaluate these benefits, a national compact stellarator program consisting of theory, experiment, international collaboration, and design was established. The National Compact Stellarator Experiment (NCSX), an experimental research facility under construction at the DOE Princeton Plasma Physics Laboratory (PPPL), was to have been the centerpiece of the U.S. stellarator program.

2. PROJECT PURPOSE & SCOPE

The mission of the NCSX was to acquire the physics knowledge needed to evaluate compact stellarators as a fusion concept, and to advance the understanding of three-dimensional plasma physics for fusion and basic science. Specific objectives were to:

- Demonstrate conditions for high-beta disruption-free operation, compatible with bootstrap current and external transform in a compact stellarator configuration.
- Understand beta limits and limiting mechanisms in a low-aspect-ratio current-carrying stellarator.
- Understand reduction of neoclassical transport by quasi-axisymmetric design.
- Understand confinement scaling and reduction of anomalous transport

by flow-shear control.

- Understand equilibrium islands and stabilization of neoclassical tearing-modes by choice of magnetic shear.
- Understand compatibility between power and particle exhaust methods and good core performance in a compact stellarator.

The key technical objective involved the design, fabrication, installation, and integrated system tests of the NCSX experimental facility, consisting of a highly-shaped vacuum vessel; surrounding magnet coil systems; enclosing cryostat and various auxiliary power; cooling, vacuum, cryogenic, and control systems; as well as a set of startup diagnostics. Figure 1 shows a cutaway view of the stellarator core assembly.

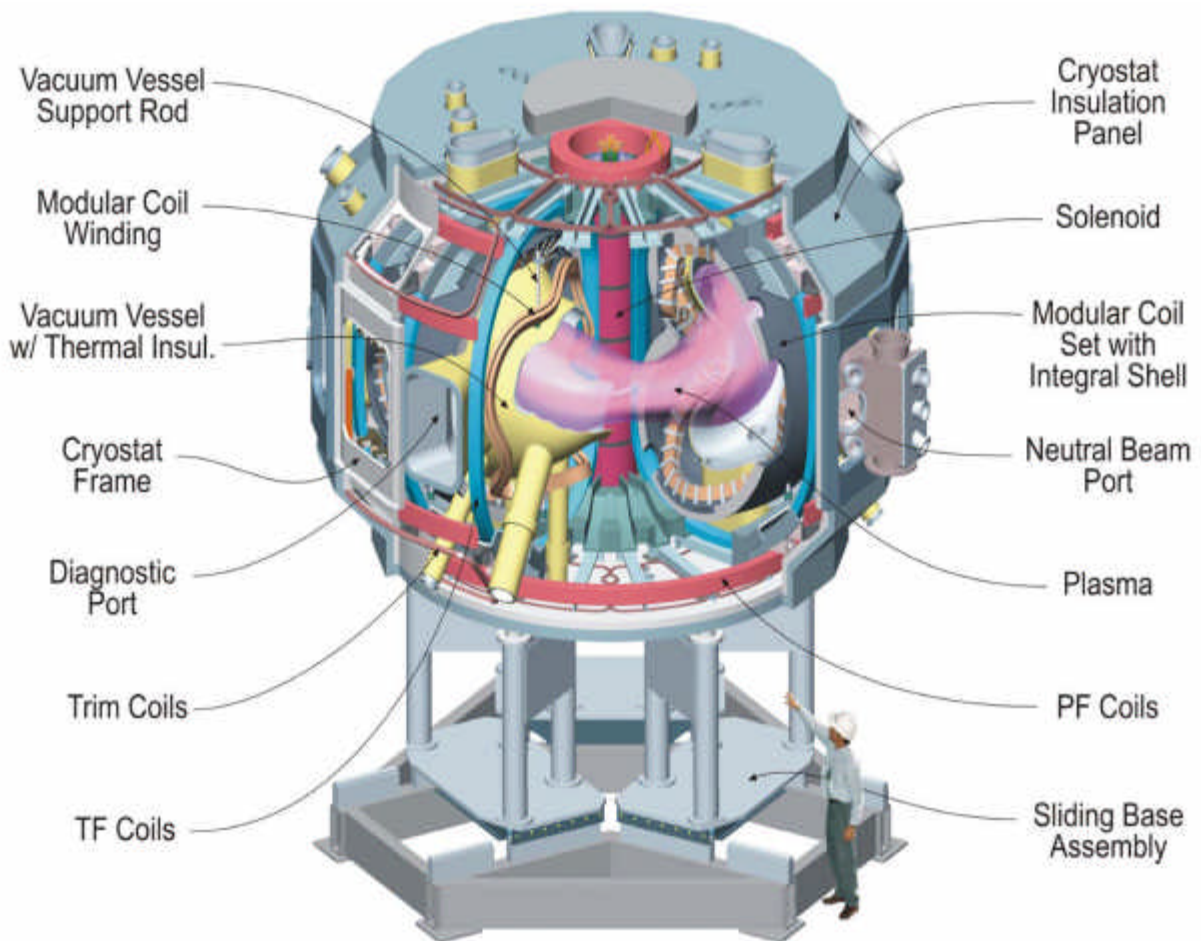

Figure 1: NCSX Stellarator core assembly

Because the project involved the fabrication of new equipment and considerable re-use of existing facilities and hardware systems and minimal civil construction, DOE designated the project as a Major Item of Equipment (MIE). The project was led by the PPPL with the Oak Ridge National Laboratory (ORNL) providing major leadership and support as a partner. PPPL had overall responsibility for the project. The plasmas to be studied were three-dimensional toroids, that is, doughnut-shaped plasmas whose cross sectional shape varies depending on where it is sliced (Figure 2). The magnetic field coils, which control the plasma shape, must be accurately constructed to precise shape specifications.

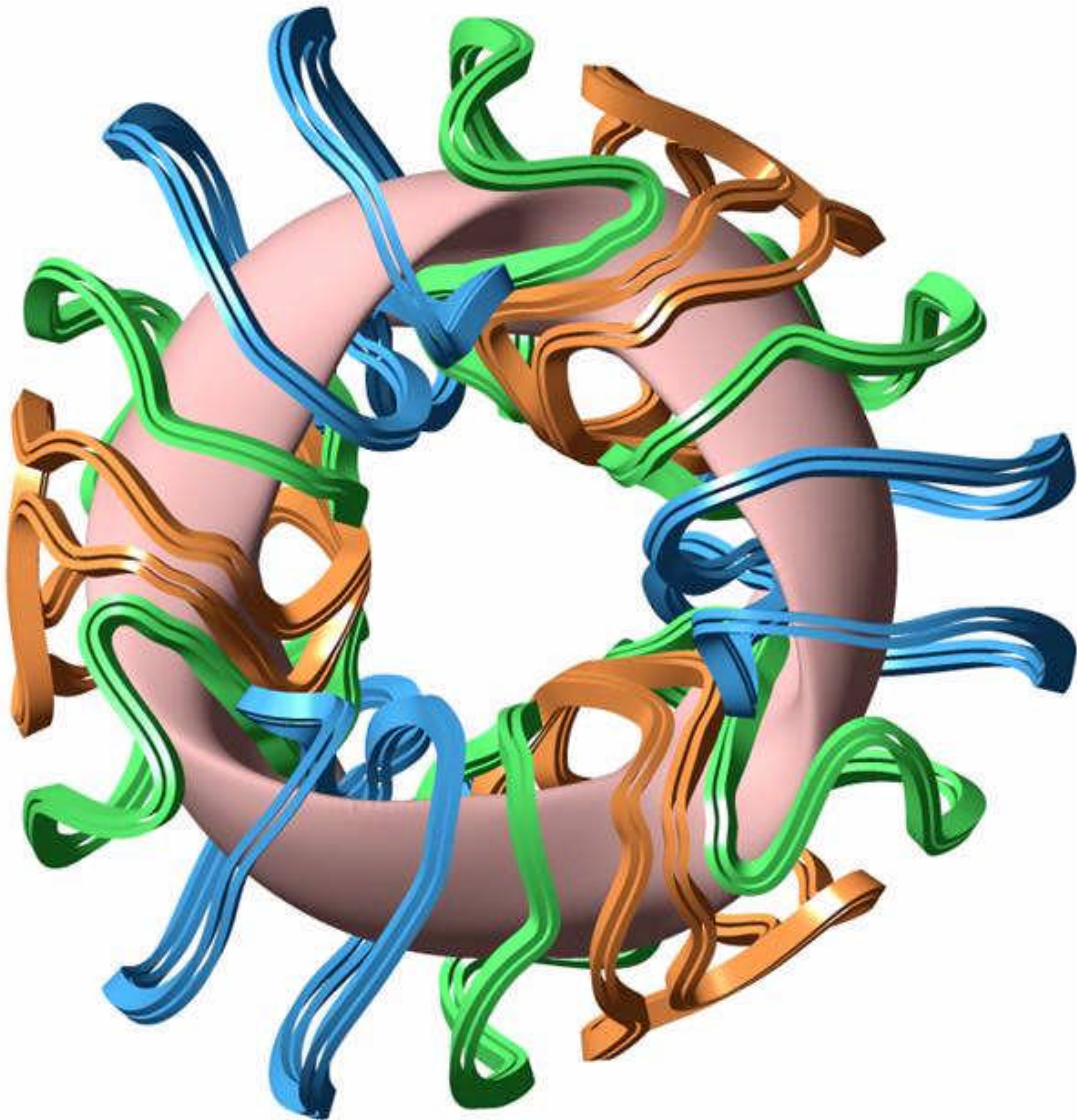

Figure 2: Illustration of the NCSX quasi-axisymmetric plasma confined with the 18 modular coils.

3. PROJECT HISTORY

In 2001, a panel of plasma physicists and engineers conducted a Physics Validation Review of the NCSX design. The panel concluded that the physics approach to the NCSX design was appropriate and that the concept was ready for the next stage of development, namely proof-of-principle. The DOE Fusion Energy Sciences Advisory Committee endorsed the panel view. NCSX Critical Decision (CD) 0, Approve Mission Need, was approved in May 2001. A May 2002 DOE Conceptual Design Review panel found that the NCSX design concept and project plans provided a sound basis for engineering development. Approval of CD-1, Approve Alternative Selection and Cost Range, was obtained in November 2002. All equipment plus a control room were to be located in existing buildings at PPPL that were previously used for other fusion experiments. Further, many of the NCSX auxiliary systems would have been made available to the project from equipment used on the previous experiments. The initial cost range of NCSX, based on the preconceptual design, was between \$69-83 million. The Total Estimated Cost (TEC) of the device based on the conceptual design was \$73.5 million with a completion date in June 2007. Due to the continuing resolution at the beginning of FY 2003 that was not resolved until February 2003, the project activities were delayed until April 2003 instead of the planned October 2002 date. With this later start and additional design and cost information, the Project estimated the TEC of the device to be \$81 million with a completion in September 2007. With DOE guidance, PPPL assembled an outside committee to perform a preliminary design review in October 2003. The preliminary design review committee concluded that the project was ready to proceed to CD-2, Approve Performance Baseline, and recommended design improvements which the project largely adopted. Approval of CD-2 was signed in February 2004 with a baseline TEC of \$86.3 million and a completion date in May 2008 after incorporating recommendations from the aforementioned reviews and an updated DOE funding profile. After various reviews, CD-3, Approve Start of Construction, was obtained in September 2004, with a TEC of \$86.3 million and a completion date in May 2008. In 2005, the NCSX funding profile was modified by OFES in response to budgetary constraints. A new baseline was developed and approved by the DOE Deputy Secretary in July 2005. This new baseline established a TEC of \$92.4 million and a July 2009 completion date.

In late 2006 it became clear that the baseline cost and schedule objectives could not be met. At a DOE-SC technical, cost and schedule review in August 2007, the project proposed a performance baseline increase to TEC by \$40 million (from \$92 to \$132 million) and extended the completion date by 29 months (from July 2009 to December 2011). The new estimates included \$14.4 million or approximately 28 percent cost contingency and 11 months or approximately 24 percent schedule contingency. The project estimates were developed using a detailed “bottoms-up” approach with contingency based

on probabilistic methodology. In early 2008, following reviews of the project's scientific mission, engineering feasibility, and cost and schedule, the DOE-SC directed the project to prepare a baseline change proposal (BCP), a draft of which was submitted in March 2008. That draft proposal was based upon an updated bottoms-up cost estimate that included: (1) new scope recommended at the 2007 DOE-SC review; (2) revised assembly estimates based upon important design and prototyping experience gained after August 2007; and (3) a more comprehensive assessment of remaining project risks. At a DOE-SC technical, cost and schedule review in April 2008, the project proposed a performance baseline TEC of \$160.6 million and completion date of August 2013. The new estimates included \$22.4 million or approximately 36 percent cost contingency and 19 months or approximately 40 percent schedule contingency.

Following several internal and external reviews in 2007 and 2008, the DOE concluded that the budget increases, schedule delays and continuing uncertainties of the NCSX construction project necessitated its closure. DOE announced its decision to terminate the NCSX project in May 2008. The Project proposed a closeout plan in June 2008 that was accepted by the DOE in July 2008. Closure of the construction effort was managed to capture many benefits of the project, *e.g.*, completion of the modular and toroidal field coils, safekeeping of materiel, and thorough documentation of designs, R&D achievements, retired and residual risks, and lesson learned, to allow revisiting this particular design if future developments in the fusion program warrant it. A chronology of key Project events may be found in Appendix A. Baseline performance objectives are listed in Appendix B.

4. PROJECT DESCRIPTION & STATUS AT CLOSEOUT

4.1 Stellarator Core

Vacuum Vessel System (WBS 12)

The vacuum vessel was to have provided the vacuum boundary around the plasma suitable for high vacuum conditions, cryostat interface flanges, bakeout heater tapes, structural support for all internal hardware, and access for auxiliary systems such as neutral beam injection and plasma diagnostics. The vacuum vessel was a highly shaped, three-period Inconel structure which approximately conforms to the plasma with multiple penetrations and ports designed to connect vacuum pumps, plasma diagnostics, and neutral beam injectors (Figures 3-5). Work included engineering design, R&D in support of design and fabrication, component procurement, and fabrication. Project scope and construction status at the end of the project are listed in Table 1.



Figure 3: NCSX vacuum vessel design.



Figure 4: One of three NCSX vacuum vessel sectors fabricated by industry and delivered to PPPL. (The port extensions were later temporarily removed during assembly operations.)



Figure 5: Vacuum vessel sub-assembly with cooling hoses and diagnostic instrumentation installed.

Table 1: Vacuum Vessel System Scope

MIE Project Scope	Status at Closeout
<p>Three vacuum vessel sub-assemblies, each consisting of a 120-degree shell sector, spacer, and associated ports</p>	<p>All components completed. The following activities would need to be done if the Project were to be restarted:</p> <p>Ports would need to be welded back on vessels during Station-5 & 6 assembly.</p> <p>Additional spacer drawings would be needed to describe as-built machining after machine assembly.</p> <p>Spacers would need to be finished machined as a result of measurements taken at assembly.</p>
<p>Heating and cooling hoses, with attachment hardware</p>	<p>Complete, except for following exceptions due to replacement of 11 reworked hoses (NCR3758) and connections loosened to correct instrumentation which needed troubleshooting. The following activities would need to be done if the Project were to be restarted:</p> <p>VVSA-1: 2 connections (1hose) will need brazing + leak check; 5 lines will need leak check only;</p> <p>VVSA-2: 14 connections (7 hoses) will need brazing + leak check; 12 lines will need leak check only;</p> <p>VVSA-3: 8 connections (4 hoses) will need brazing + leak check; 13 lines will need leak check only.</p>
<p>Heating and cooling manifolds</p>	<p>Complete.</p>
<p>Cryostat interface flanges</p>	<p>Port 12 flanges completed and installed on the VVSA. Preliminary design for remaining flanges complete, but detail drawings not started.</p>
<p>Heater tapes</p>	<p>Complete.</p>
<p>Supports</p>	<p>Design: 100% complete. 100% of parts delivered. Not installed.</p>
<p>Thermocouples and other instrumentation</p>	<p>Complete.</p>
<p>Thermal insulation</p>	<p>Title-I & II design complete.</p> <p>Port insulation materials were delivered, but were returned to the vendor for credit when Project was cancelled. If the Project were to be restarted these materials would have to be repurchased.</p> <p>If the Project were restarted, further considerations would be needed for:</p> <p>Port insulation assembly;</p> <p>R&D to assure voids between vacuum vessel and modular coil are filled; and</p> <p>Ensuring non-flammability criteria are met.</p>

Conventional Coils (WBS 13)

The conventional coil systems scope included the fabrication of eighteen toroidal field (TF) coils (Figure 6), six poloidal field (PF) coils (Figure 7), forty-eight trim coils (Figure 8) for control of low-order helical field harmonics, local instrumentation, and certain support structures. The TF coils are identical, and were to be installed equally spaced, providing flexibility in the magnetic configuration. TF coils were wound from copper conductor, assembled to steel support wedges, and vacuum impregnated with epoxy. They were designed to operate at the liquid nitrogen (LN₂) cryogenic temperatures. The PF magnets produce the poloidal magnetic field within the NCSX device. These coils were to provide inductive current drive and plasma shape and position control. The coils were to be wound from copper conductor and vacuum impregnated with epoxy, and also designed to operate at the LN₂ temperatures. Existing PF solenoids from the National Spherical Torus Experiment (NSTX) were to be utilized as the initial central solenoid for NCSX. Project scope and construction status at the end of the project are listed in Table 2.



Figure 6: One of the 18 NCSX toroidal field coils fabricated by industry and delivered to PPPL.

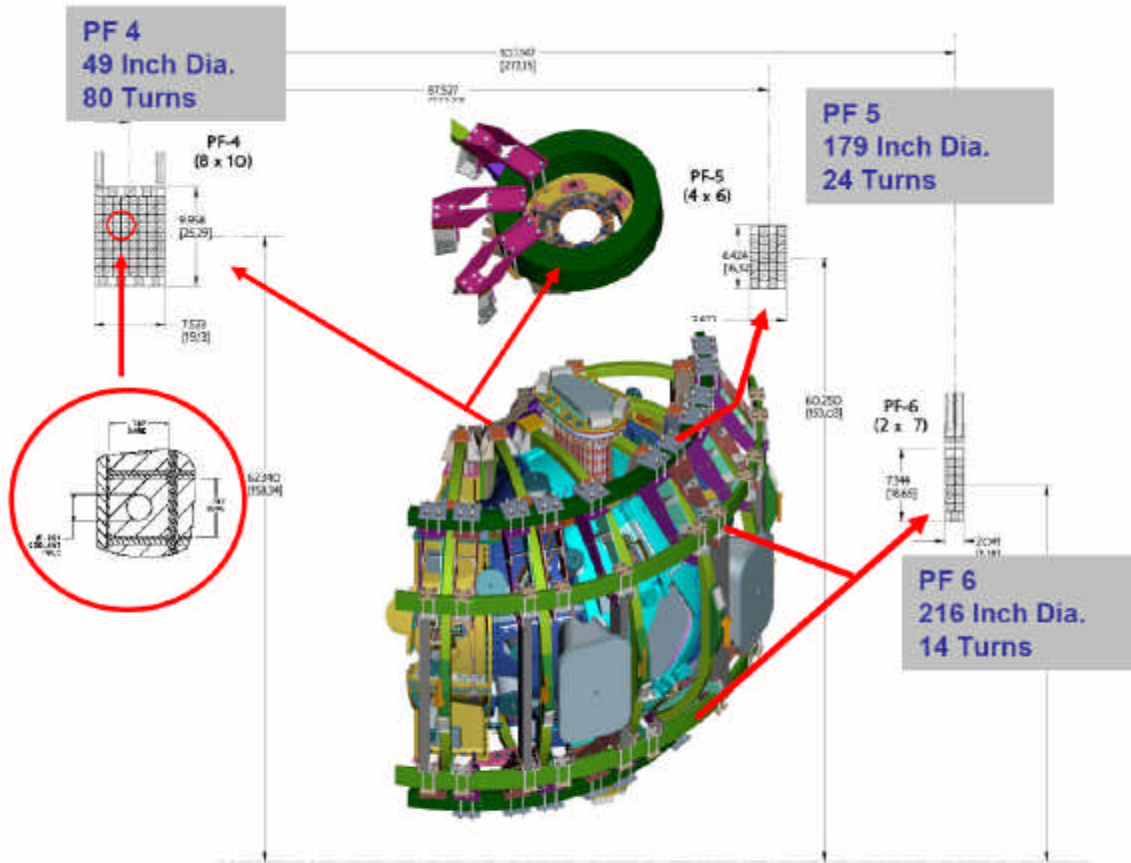

Figure 7: Poloidal field coils design

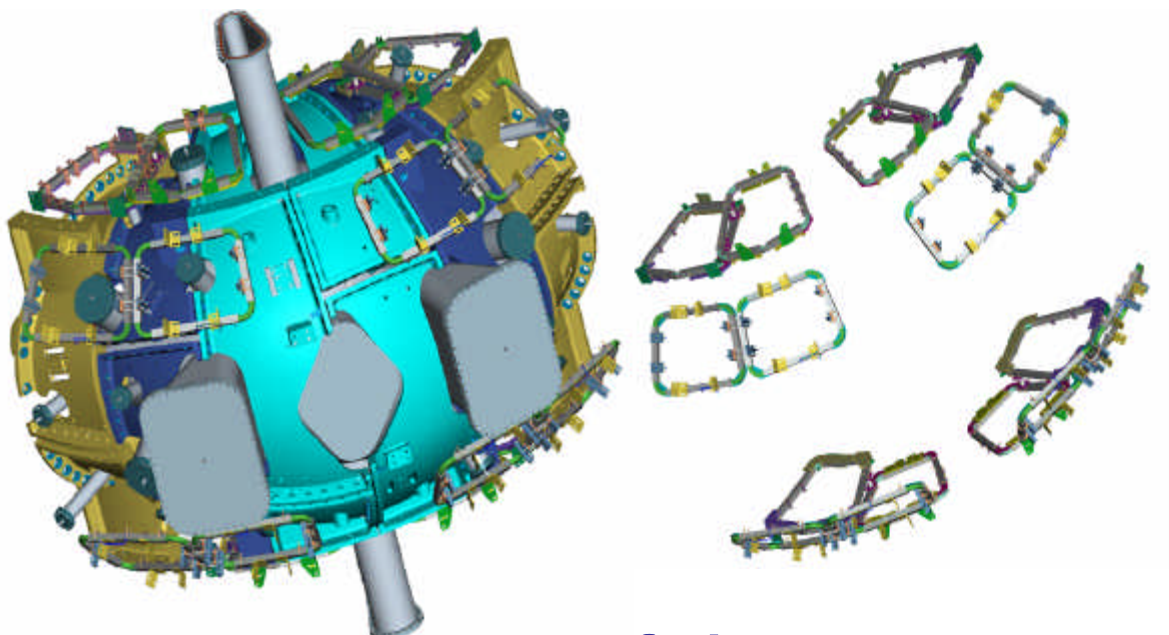

Figure 8: Trim coils design

Table 2: Conventional Coils Scope

MIE Project Scope	Status at Closeout
TF Coils: Design and fabrication of eighteen TF coil assemblies consisting of D-shaped coils assembled to wedge support pieces	Complete.
PF Coils: Design and fabrication of three pairs of PF ring coils. Central Solenoid will utilize existing PF-1a solenoid from NSTX	Design & specifications are complete; fabrication contract award was pending at time of Project cancellation. Re-startup of the PF coils would require a new RFP and award of contract. The existing RFP and supporting procurement documentation will be retained for 5 years from Project cancellation – May, 2013. Retrofit design of NSTX central solenoid leads not started.
Trim coils: Design and fabrication or procurement of trim coils required for MIE project.	Final design complete.
Local I&C: Fabrication and installation of local instrumentation for the conventional coils, e.g., thermocouples, strain gauges, RTDs, and voltage taps	Not started.
CS support structure: Fabrication and installation of the support structure for existing central solenoid coils, and procurement and installation of I&C for those coils	Final design complete.

Modular Coils (WBS 14)

The modular coils consisted of eighteen complex-shaped coils supported on the interior surface of a toroidal shell structure (Figures 9-17). The coils are fabricated on 2700 kg castings made from a specially developed modified CF8M alloy named Stelalloy. There are three types of coils differing primarily in their shapes (Figure 9). The coils are fabricated from flexible copper cable conductor wound on the inner diameter of a support structure called a modular coil winding form (MCWF), and vacuum impregnated with epoxy. In the finished assembly, the modular coils are arranged in three identical field periods, each containing six coils, two of each type. The winding forms are joined together at their mating flanges to form a stiff toroidal structure when completed (Figure 11). By adjusting the coil interfaces appropriately, one could make the effects of the errors in the winding completely negligible. The flange interfaces between the modular coils utilize a combination of electrically insulated custom-fitted friction shims, insulated studs, and specially designed low-distortion welded connections in some regions to provide strong,

stable structural interfaces between the winding forms along with accurate coil positioning and an adequate electrical time constant to facilitate magnetic field penetration. The coils are designed to operate at LN2 cryogenic temperatures. Work included engineering design, R&D in support of design and fabrication, component procurement, tooling and fixtures, fabrication, and sub-assembly. While R&D activities such as developing winding and casting techniques were essential, a total understanding of all manufacturing activities was not fully realized until production was undertaken (Figure 18). During the winding and epoxy impregnation process, refinements were continually made which reduced coil assembly time from 7000 man-hours down to approximately 1000 man-hours (Figure 19). There were many challenges that were overcome during the coil winding process; one of the most significant was the metrology. In order to minimize islands in the toroidal flux to less than 10%, a tolerance in the positioning of the modular coil winding pack of ± 0.5 mm or less was required. Through careful assembly and after-winding shaping techniques the tolerance was achieved on almost all points on the winding path (Figure 20). Project scope and construction status at the end of the project are listed in Table 3.

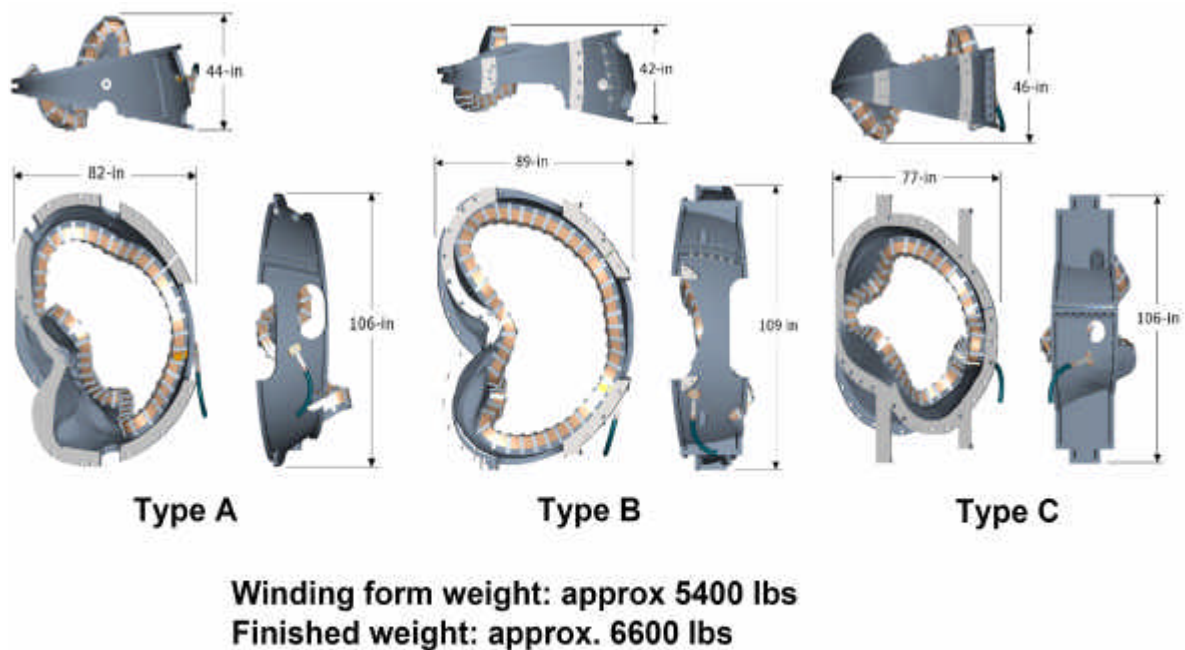

Figure 9: The three modular coil types.

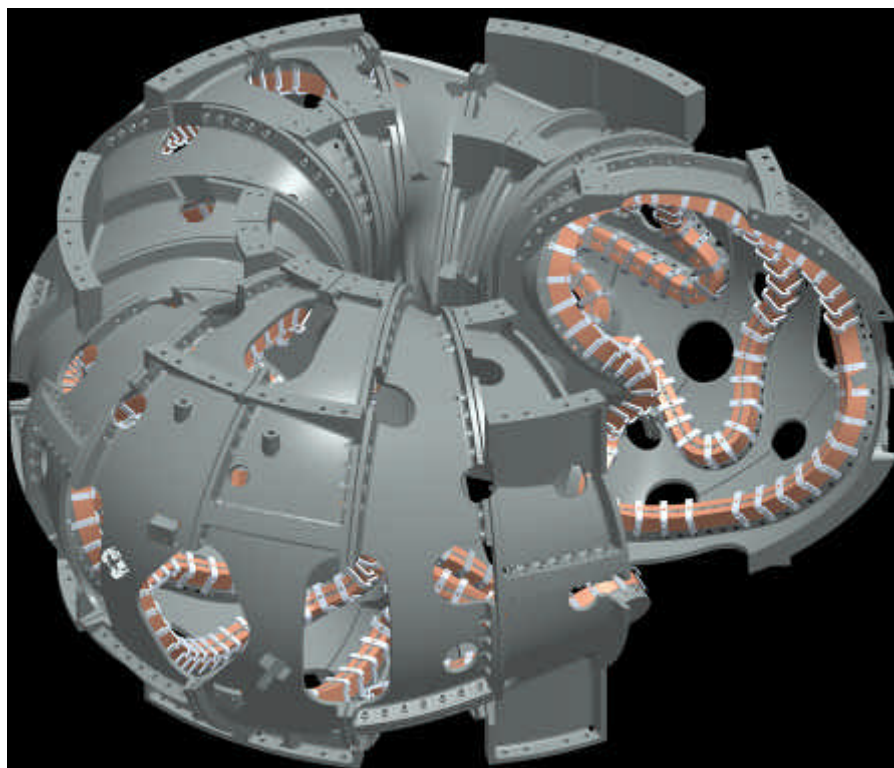

Figure 10: Modular coil assembly.

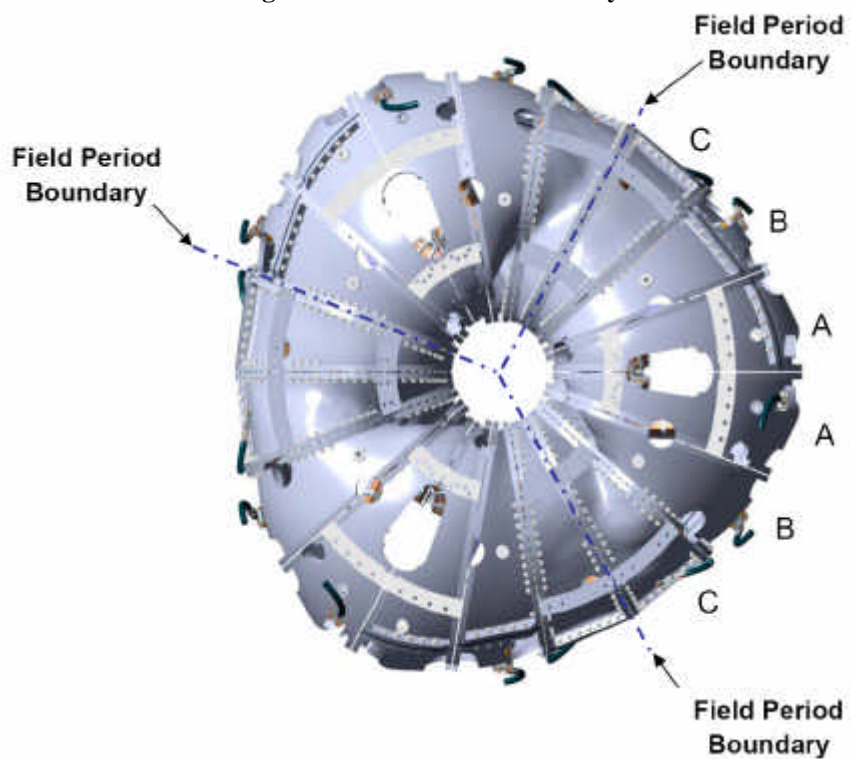

Figure 11: Top view of the modular coil form assembly.

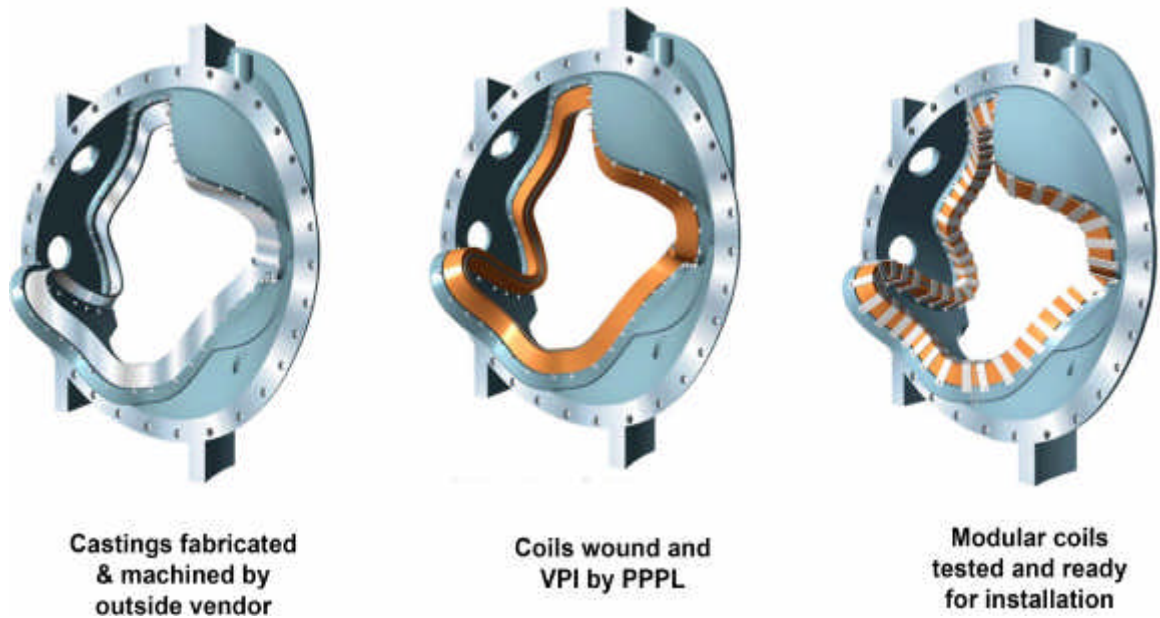

Figure 12: Phases of modular coil fabrication.

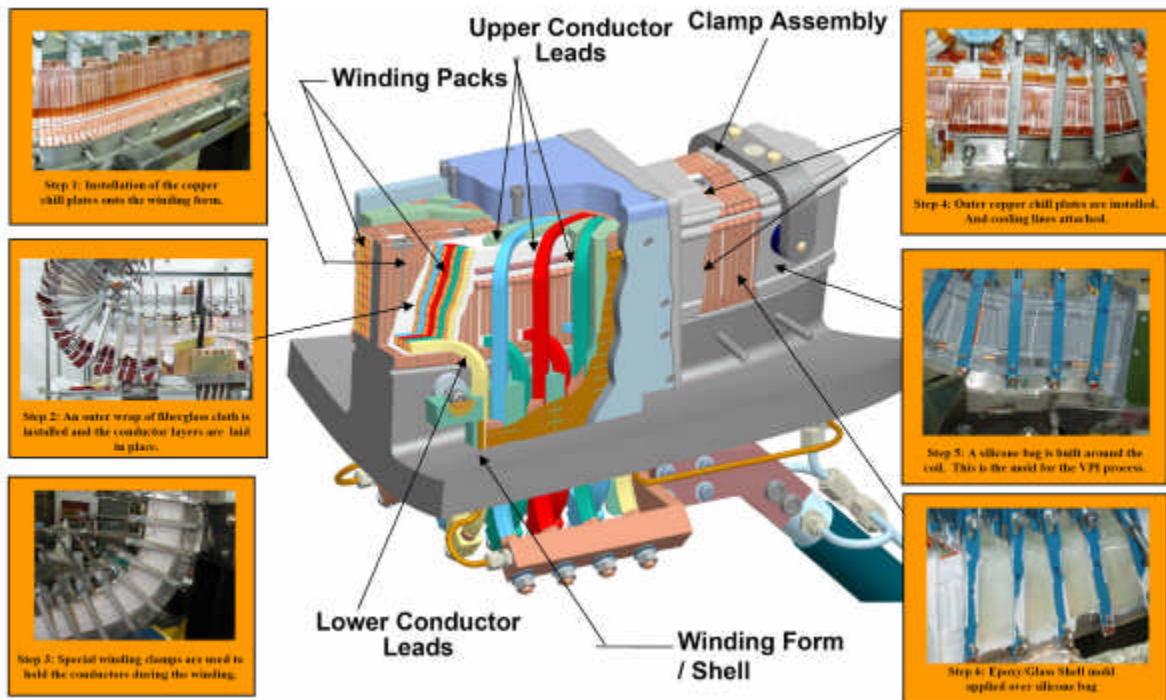

Figure 13: Manufacturing steps for a modular coil.



Figure 14: Modular coil winding form fabricated by industry and delivered to PPPL.



Figure 15: Modular coil winding operations at PPPL.

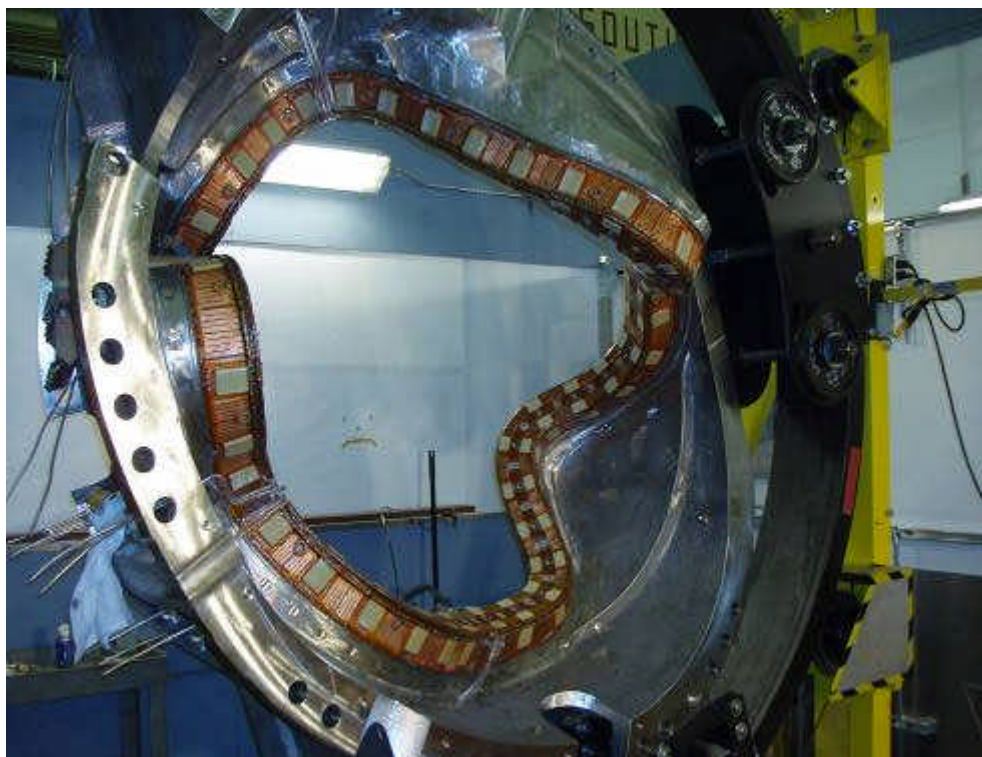

Figure 16: Modular coil after vacuum-pressure impregnation (VPI).



Figure 17: Modular coil with clamps installed.

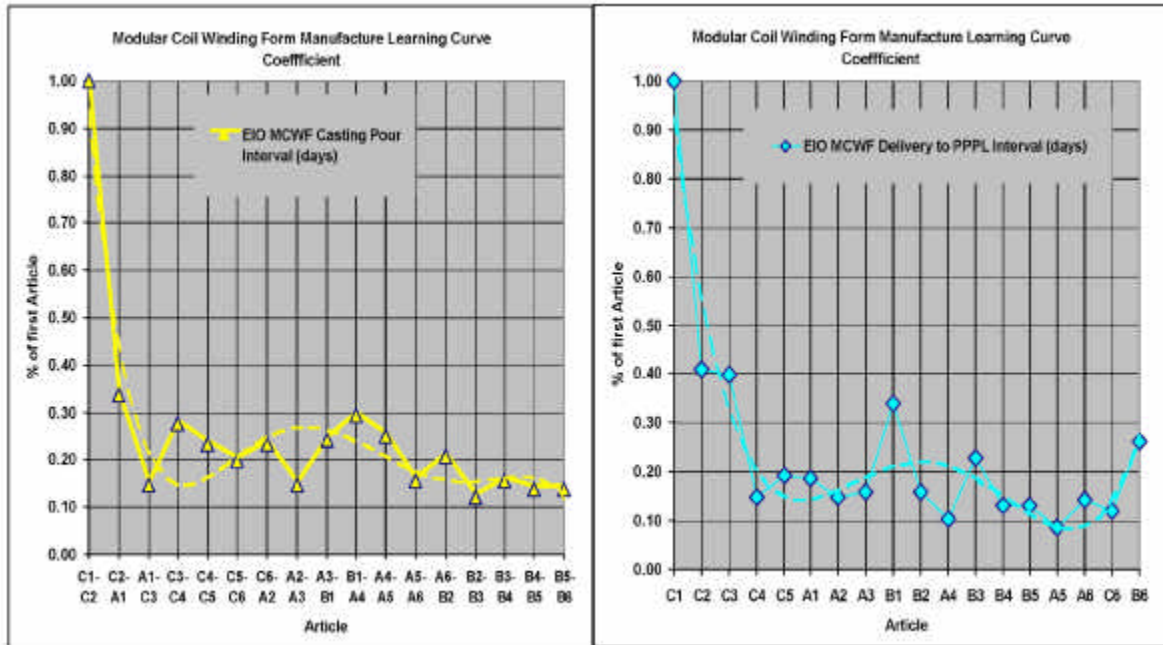

Figure 18: Learning curve for manufacture of MCWF: (1) time intervals between castings normalized to the interval between the first and second article; and (2) time intervals between MCWF deliveries normalized to the time between receipt of the first article casting and delivery of the machined first article to PPPL.

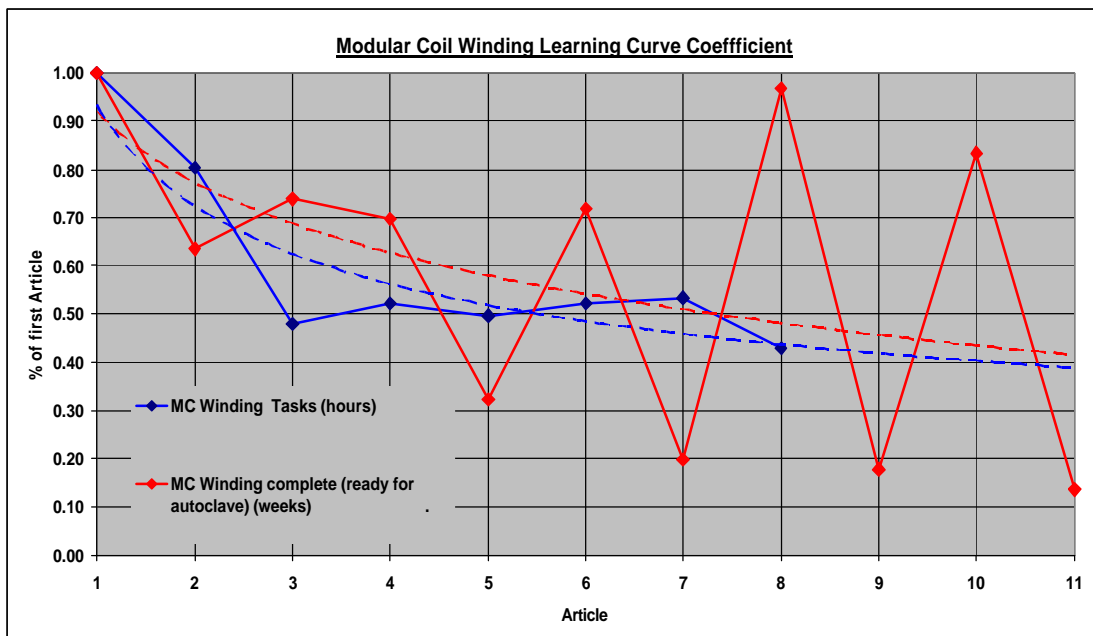

Figure 19: Learning curve realized in winding the first 11 modular coils. Data points denote the time intervals between completion successive coils normalized to that between the first and second articles. Oscillations are an artifact from the use of two separate winding teams working in parallel and becoming out of sync with one another. The dashed curves are polynomial fits to the experimental data.

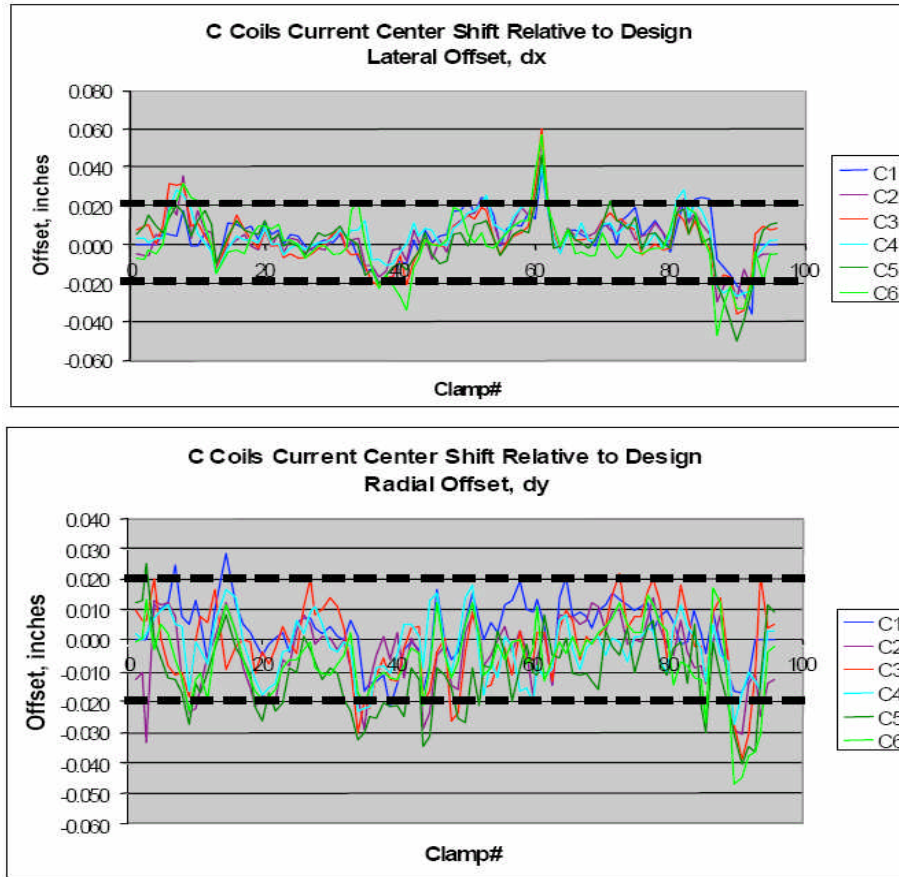

Figure 20: Measured current center positions for all six Type C modular coils.

Table 3: Modular Coils Scope

MIE Project Scope	Status at Closeout
MCWF: Delivery of eighteen winding forms to modular coil fabrication operations	Complete.
Completed coils: Delivery of eighteen instrumented coils and assembly hardware to assembly operations	Coil winding, VPI, post-VPI activities, and warm testing: Complete. Full-current testing of one coil at cryogenic temperature: Complete. Thermocouple installation: 50% Complete Strain gage installation: 0% Complete.
Design: Delivery of drawings, specifications, and models to fabrication and assembly operations; and documentation of coil protection limits.	All models, drawings, and specifications for the modular coil assemblies (SE104-10X, SE140-230 Rev-1) issued for fabrication and assembly.
Tooling: Delivery and installation (as appropriate) of tooling for the modular coil fabrication facility.	Complete.
Interface hardware: Delivery of modular coil interface parts to assembly operations	Detailed fabrication, assembly, and some as-built drawings issued.

Conventional Coil Structures (WBS 15)

The coil support structures were to have provided the mechanical supports connecting TF, PF ring coils (PF 4, 5, and 6, see Figure 21), and trim coils to the modular coil toroidal shell and the base support structure. Work included engineering design, procurement, and fabrication of structures and associated instruments and controls. The coil supports interfaced with the MCWF shell which provided the load path to react all coil electromagnetic and gravity loads. It also interfaced with mounting hardware for supporting coil buswork, cryogen lines and cryostat. Project scope and construction status at the end of the project are listed in Table 4.

Coil Services (WBS 16)

The coil services consisted of the LN₂ distribution system (Figure 22) and electrical leads (Figure 23) inside the cryostat, serving all of the coils. It also included the specification of requirements for the coil protection system. Work included engineering design, procurement, and fabrication of manifolds, cooling pipes, fabrication of leads and associated supports and instrumentation and controls. Project scope and construction status at the end of the project are listed in Table 5.

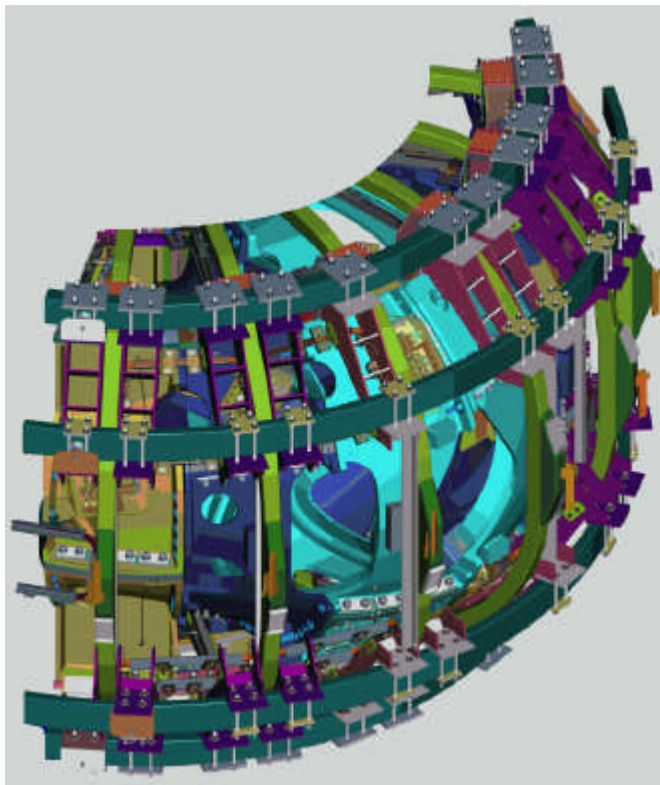

Figure 21: Outer poloidal field coil supports.

Table 4: Conventional Coil Structures Scope

MIE Project Scope	Status at Closeout
<p>Design, fabrication, and delivery of coil support structure components to machine assembly operations.</p>	<p>Final design complete. Final design review judged successful pending resolution of open chits. Two chits from the FDR and four remaining from PDR were left open, pending re-start of NCSX since their resolution was dependent on work stopped due to NCSX closeout.</p>

- Manifolds lie outside TF coils
 - supplies near bottom of VV
 - returns near top of VV.

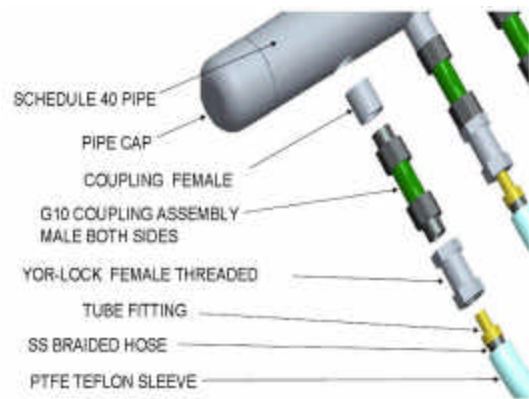
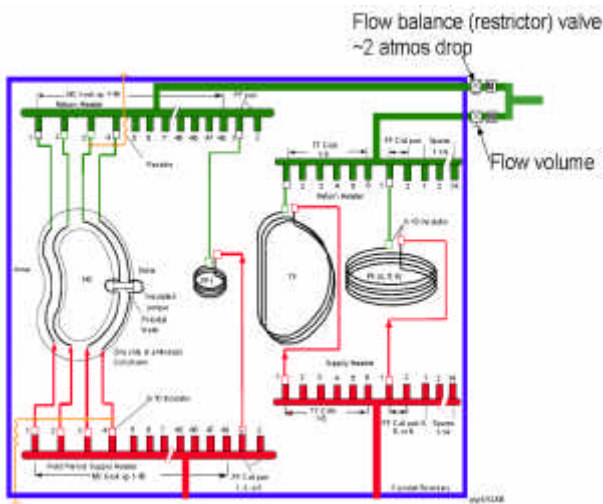
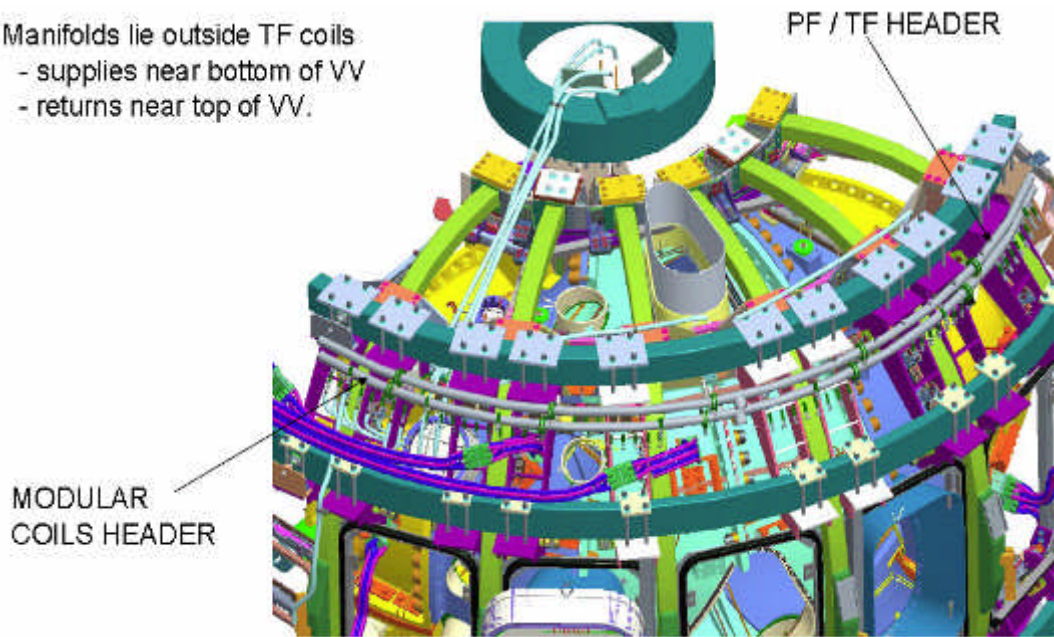

Figure 22: Schematics illustrating LN2 distribution.

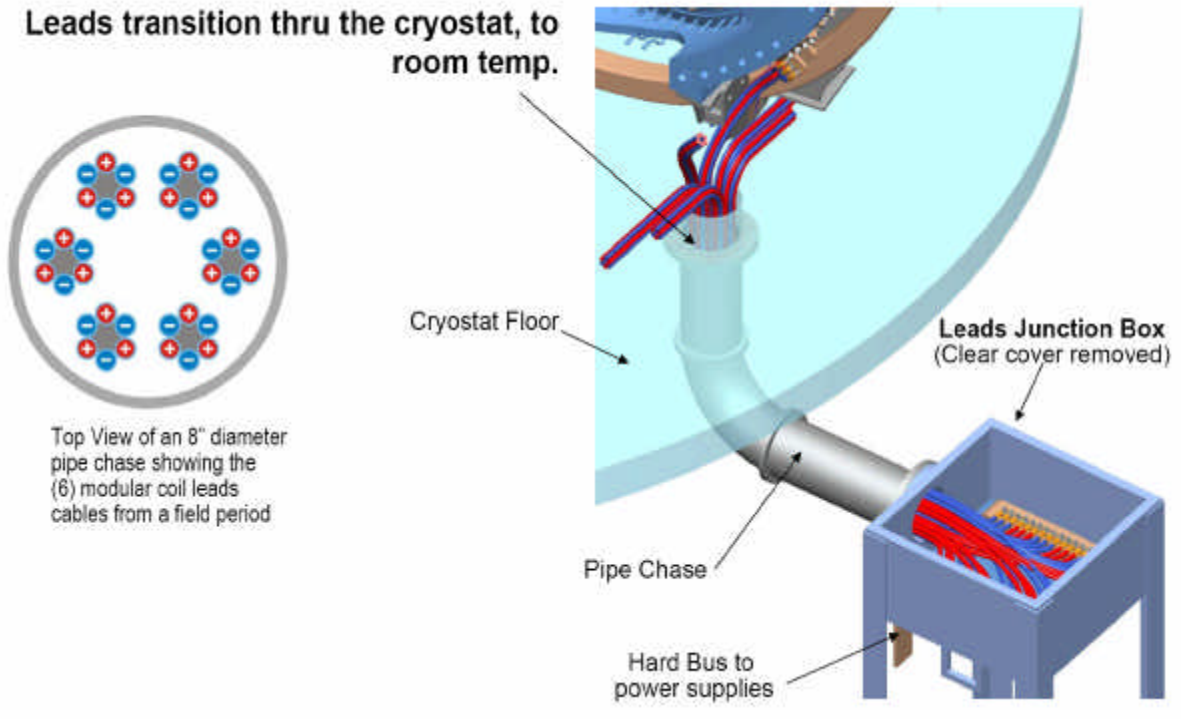

Figure 23: Schematic illustrating coil electric power distribution.

Table 5: Coil Services Scope

MIE Project Scope	Status at Closeout
<u>LN2 distribution system:</u> Engineering design, procurement, and fabrication of manifolds, cooling pipes, and associated supports and I&C, and delivery of components to machine assembly operations.	Preliminary design for LN2 System (WBS1601) complete. R&D, procurement, fabrication & assembly work had not started.
<u>Electrical leads:</u> Engineering design, procurement, and fabrication of leads and associated supports, and delivery of components to machine assembly operations.	Preliminary design on lead system (WBS1602) approximately 75% complete.
<u>Coil protection:</u> Delivery of coil protection requirements to the coil protection system design activity	Not started.

Cryostat & Base Structure (WBS 17)

A cryostat (Figure 24) was to have enclosed the NCSX device to provide a suitable thermal environment for the magnets, and provided thermal insulation and a tight seal to isolate the cold gaseous nitrogen atmosphere surrounding the coils and cold structure from

the ambient atmosphere. It would also have provided a means for circulating dry nitrogen inside the cold volume to cool down and maintain the temperature of the interior structures. Special emphases were placed on documenting the cryostat design, which was still in the design process prior to project termination, as it had significant integration impacts on interfacing components. The base support system (Figure 25) would have provided the gravity support for the core device (vacuum vessel and coils) and also thermal isolation of the cold structure from the floor. Project scope and construction status at the end of the project are listed in Table 6.

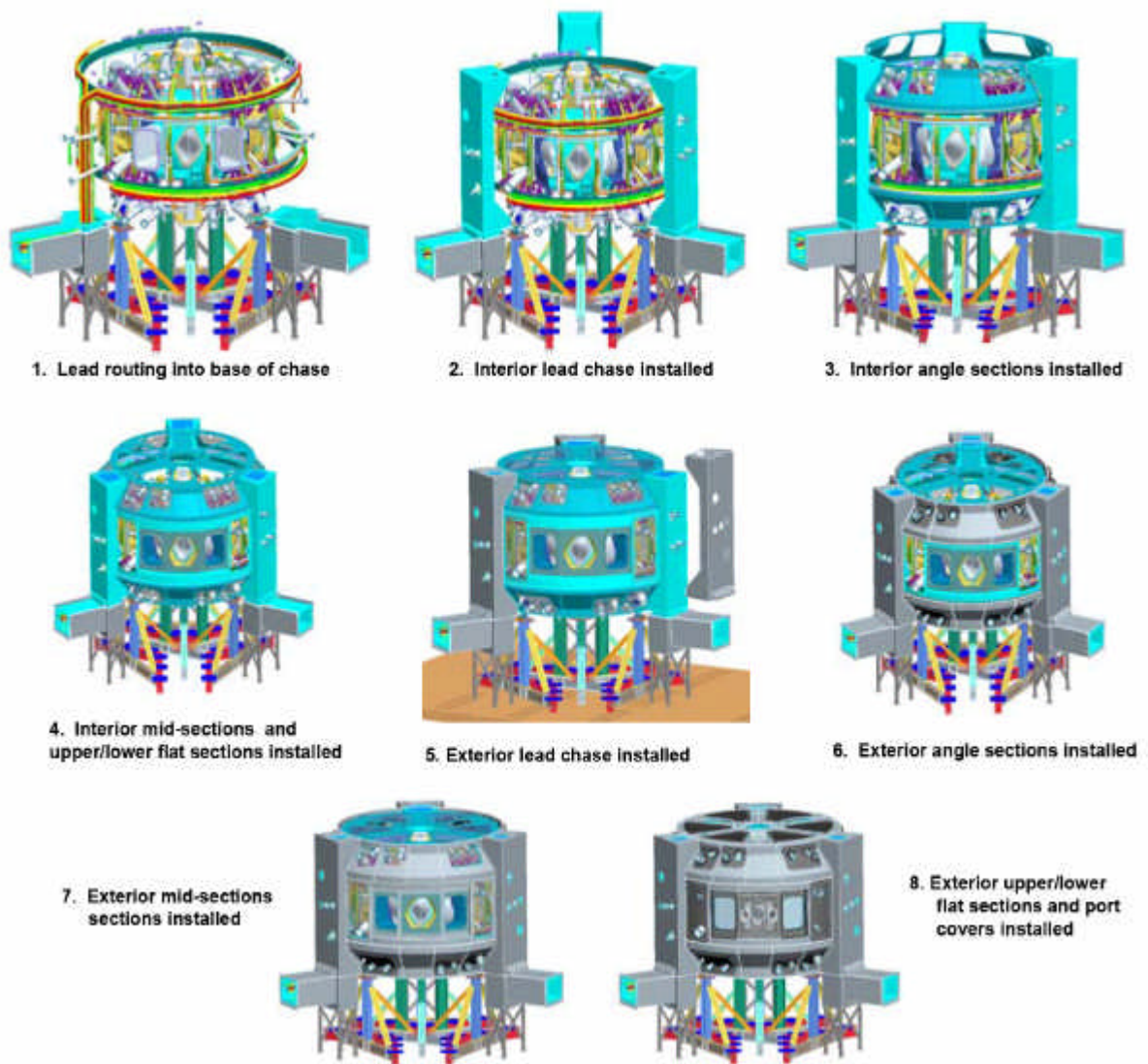

Figure 24: Conceptual schematic of the NCSX cryostat assembly process.

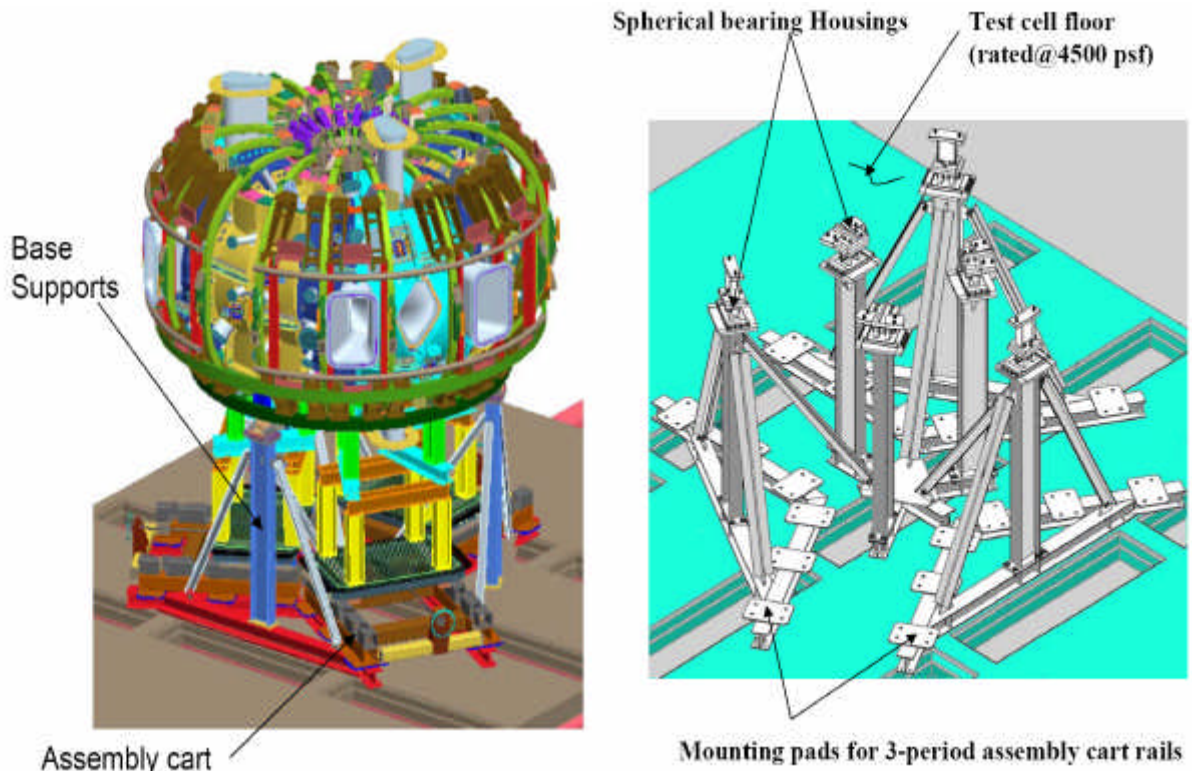

Figure 25: Base supports design; assembly cart (WBS 18) also shown in illustration on left.

Table 6: Cryostat & Base Structure Scope

MIE Project Scope	Status at Closeout
<p>Cryostat: Engineering design, procurement, and fabrication of the cryostat shell and structure components, insulation, attachments for the structural support of internal components, and penetrations for electrical, cooling, and mechanical support services. Delivery of components to machine assembly operations.</p>	<p>A Peer Review of the cryostat involving experts from other laboratories and industry was held on April 23, 2008. A cryostat and cryosystem development plan was formulated based on input from the review. The targeted completion dates for Final Designs were in the 2nd quarter of CY 09. At the time of closeout, a cryostat shell design compatible with the structures, internal components, and penetrations was well underway. A subcontract that was being negotiated for expert support to guide the completion of the shell design, insulation, and integration was terminated.</p>
<p>Base support structure: Engineering design, procurement, and fabrication of the permanent base support structure for the machine. Delivery of components to machine assembly operations.</p>	<p>Final design complete. Only the spherical bearings were procured; no fabrication was started.</p>

Field Period Assembly (WBS 18)

This activity included the assembly of the vacuum vessel, modular coils, toroidal field (TF) coils and trim coils into three identical modules known as field periods (Figure 26). Each field period contains one vacuum vessel sub-assembly (120-degree shell sector and ports), six modular coils (two each of the three types), six toroidal field coils, sixteen trim coils, and associated coil support structures; two of the six TF coils were to be installed during final machine assembly (WBS 7). Field period assembly work included engineering design, R&D in support of design and fabrication, component procurement, tooling and fixtures, and assembly. The three different modular coils were to be aligned, bolted and welded together to form a half period assembly (HPA). Alignments were measured to a precision of 0.08 mm and maintained to position requirements of 0.50 mm (0.020 in) or less. Project scope and construction status at the end of the project are listed in Table 7.

The design of the modular coil interfaces was a greater challenge than anticipated. Successful innovative technical solutions were found for every problem encountered (albeit at the expense of project cost and schedule – *cf.* Sections 6.1 and 8). Advances were made in global structural analysis of a complex structure, with analytical models derived directly from CAD models for accurate representation. A low-distortion welded joint needed to be developed, based on a hardware configuration and a low-heat input process (using MIG welding and flux core weld wire) to minimize the deflection of nearby windings during assembly. Enhanced-friction insulating shim designs were developed, using thin G10 layers for medium friction and alumina coatings for high friction. Special long-reach tooling was developed to assemble bolts in limited-access areas, making it feasible to reduce the bolt-free length on the inner leg of the inter-period joint. Concurrent with and supportive of the design effort, an assembly process was developed that was compatible with dimensional control requirements, metrology capabilities, and cost-effective assembly approaches. By the time the project was terminated, two of the six modular coil HPAs were successfully completed (Figure 27). Dimensional control results were excellent, *e.g.*, out of 105 measurements on a completed HPA, all but four positions were within 0.38 mm (0.015 in), while only one of the remaining four positions was 0.025 mm (0.001 in) out of tolerance.

A successful trial installation of a HPA over the vacuum vessel was completed in four hours (Figure 28). With custom tooling, the HPA was carefully translated and rotated in six degrees of freedom to clear the vacuum vessel. No interferences or other unexpected difficulties were encountered. This test demonstrated the feasibility of one of the most critical NCSX assembly operations by validating the assembly tooling, an innovative CAD model-laser guidance technique, and procedures. It also showed that risks of encountering interferences between the coils and the vessel during assembly are readily managed, and provided data on assembly times and crew requirements. These data have been factored into the cost and schedule estimates for the remaining work (Sec. 6.2).

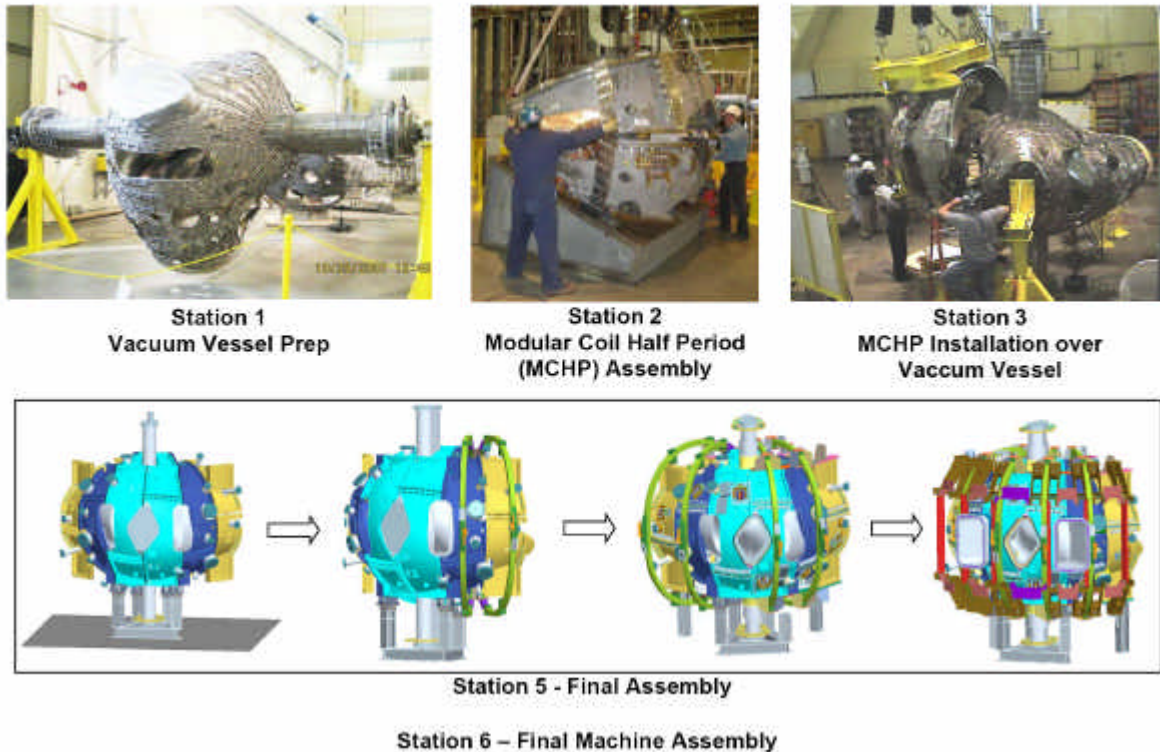

Figure 26: NCSX assembly was to be performed at 5 distinct stations.

Table 7: Field Period Assembly Scope

MIE Project Scope	Status at Closeout
<p>Design: Delivery of drawings, specifications, and models to field period assembly and machine operations.</p> <p>Station 1: Delivery and receiving inspections of 3 vacuum vessel assemblies (plus port extensions), to Station 3</p> <p>Station 2, 3, and 5: Delivery of three field period modules to machine assembly operations.</p> <p>Tooling: Delivery and installation (as appropriate) of tooling for field period assembly.</p> <p>Metrology: Design, procure, & fabricate metrology equipment needed for field period assembly.</p>	<p>Station 2: Complete.</p> <p>Station 3: Complete.</p> <p>Station 5: 50% complete (drawings 90% complete; specifications not started).</p> <p>Station 6: 40% complete (drawings 60% complete; specifications not started).</p> <p>Complete.</p> <p>Two half periods assembled (Station 2).</p> <p>Trial assembly of half-period over VV sector completed (Station 3).</p> <p>Station 1: Complete.</p> <p>Station 2: Complete.</p> <p>Station 3: Complete.</p> <p>Station 5: Not Started.</p> <p>Station 6: Not Started.</p> <p>Complete.</p>

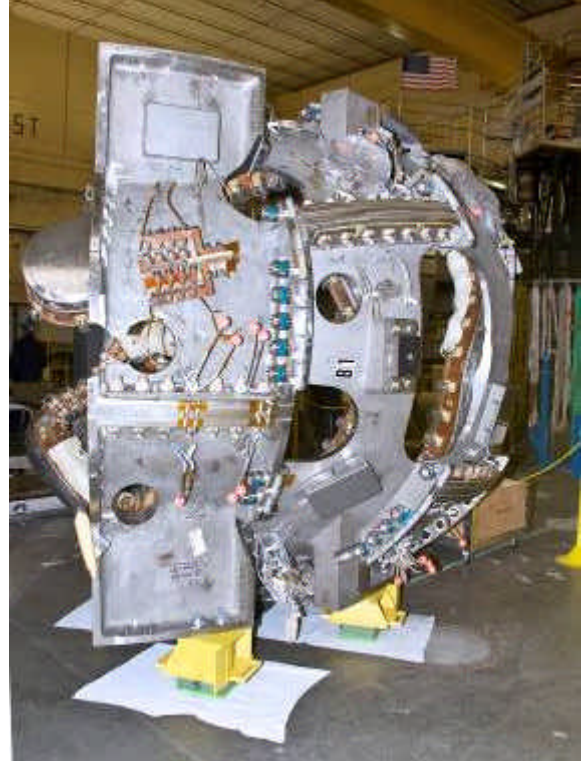
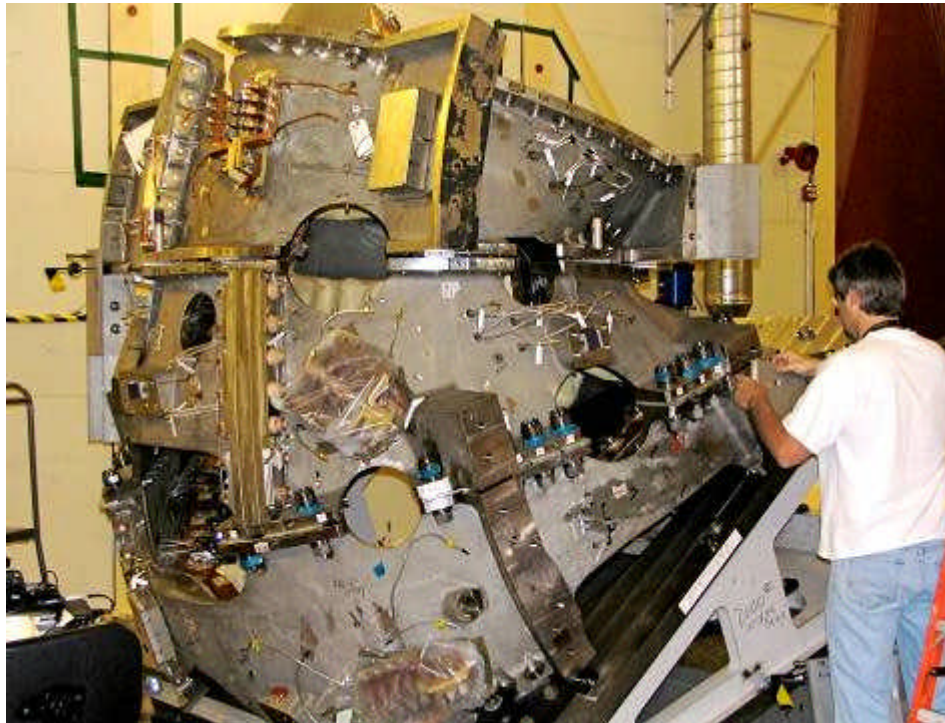

Figure 27: Assembled half field period.

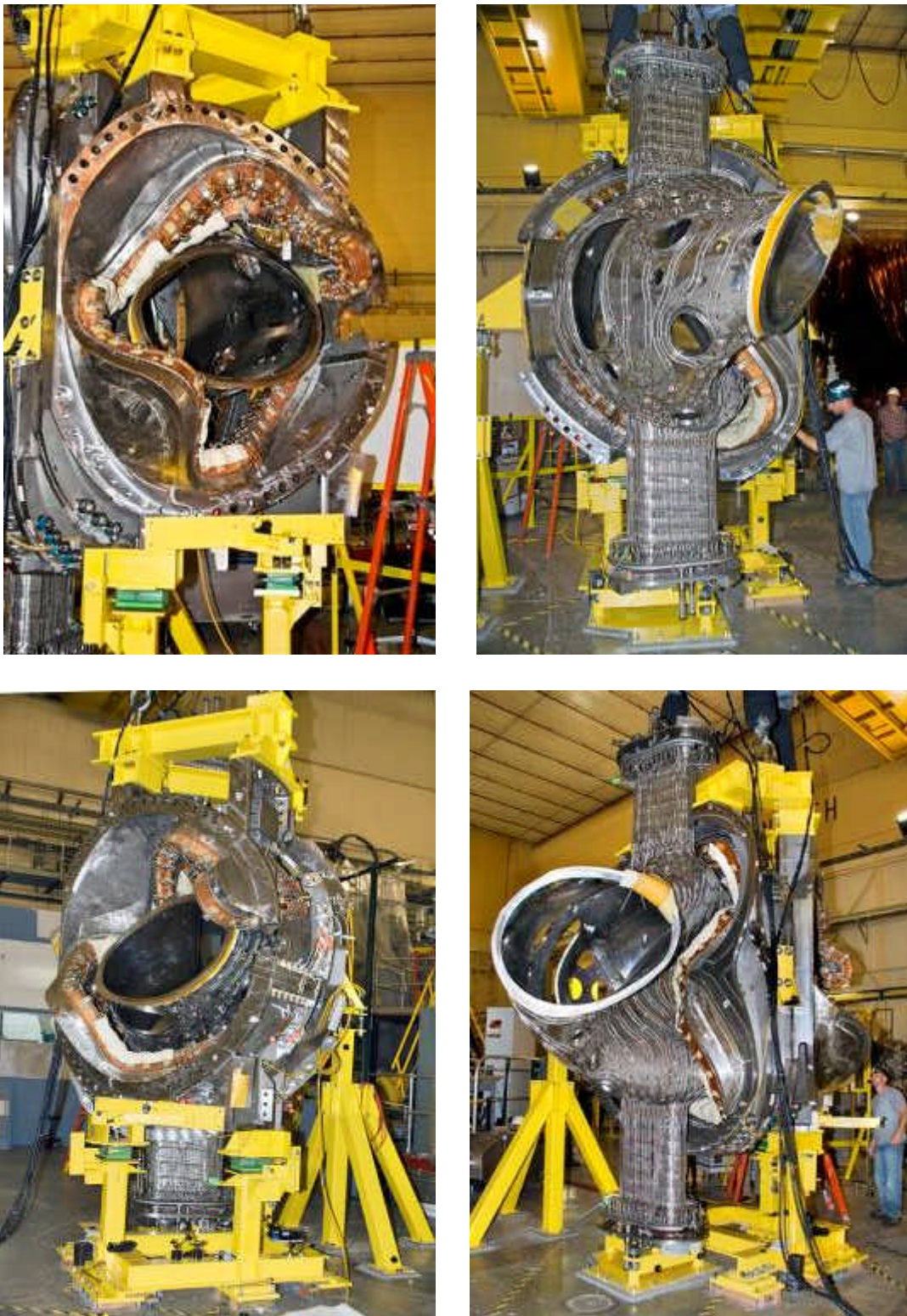

Figure 28: Half-field period assembly installed over vacuum vessel sub assembly.

4.2 Auxiliary Systems (WBS 2)

MIE project scope included gas fueling system, vacuum pumping system (Figure 29 and Figure 30), and an evaluation of an existing PPPL neutral beam system for potential future use after the planned completion of the Project. Work included design, R&D to support the design effort, component fabrication, assembly, installation, system level commissioning and testing. Project scope and construction status at the end of the project are listed in Table 8.

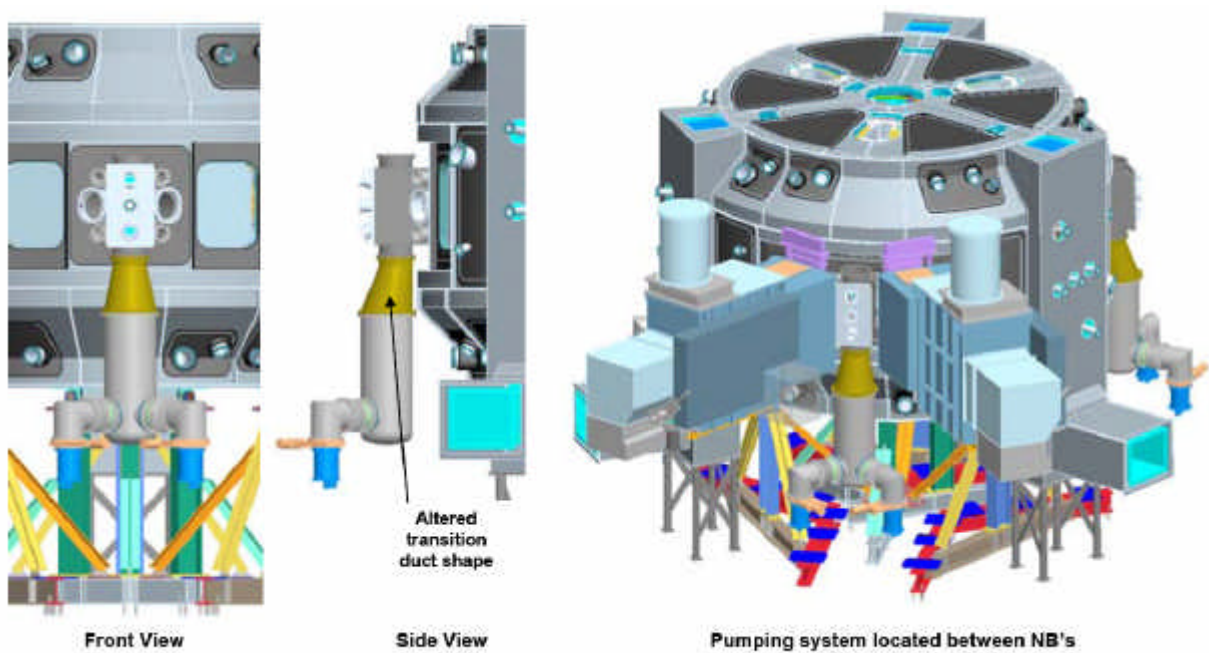

Figure 29: Vacuum pumping system schematic.

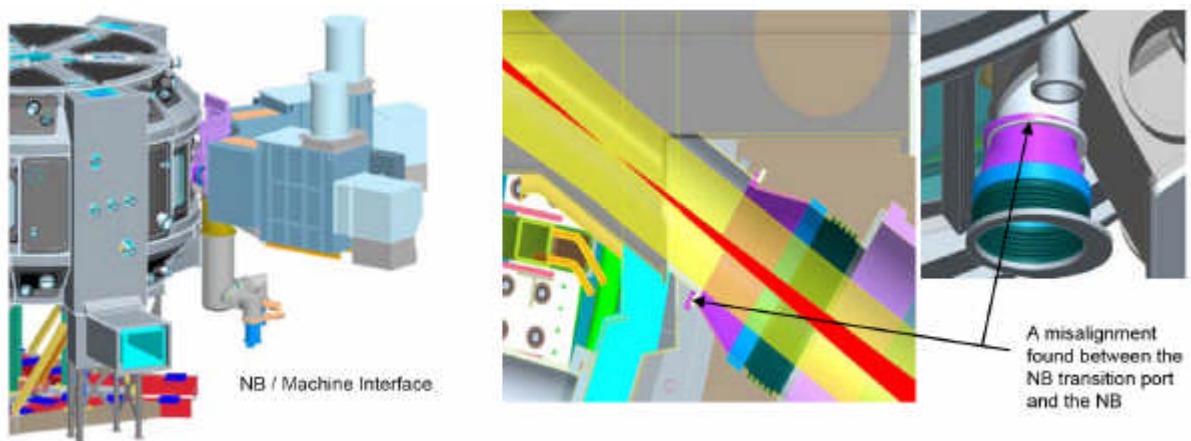

Figure 30: Neutral beam interface schematic.

Table 8: Auxiliary Systems Scope

MIE Project Scope	Status at Closeout
<u>Fueling</u> : Design, fabrication, refurbishment, installation, and system testing of gas fueling equipment capable of injecting H ₂ , D ₂ , or He gas into the plasma. Components include a gas delivery line, and pulse valve control.	Design ~25% complete. No parts were procured, fabricated or refurbished. Neither installation nor testing of the system had been started.
<u>Torus vacuum pumping</u> : Design, fabrication, installation, and system testing of turbomolecular pumps backed by existing mechanical vacuum pump systems.	Design ~30% complete. No parts were procured, or fabricated. Installation of the system had not been started. System testing ~30% complete (offline tests of legacy TMPs and mechanical pumps).
<u>Neutral beam</u> : Evaluate, for future use, a neutral beam injection including one beamline, power systems, ac power, & controls system, based on existing C-site NBI system.	Complete.

4.3 Diagnostics (WBS 3)

Diagnostic systems would have provided measurements of first plasma parameters. The NCSX MIE Project included the following diagnostics: (1) magnetic field probes and flux loops; (2) an existing fast visible TV camera to measure edge and divertor plasma; (3) an electron beam mapping apparatus to measure properties of the magnetic surfaces including shape and topology. Project scope and construction status at the end of the project are listed in Table 9.

Table 9: Diagnostics Scope

MIE Project Scope	Status at Closeout
<u>Magnetics</u> : Co-wound magnetic flux loops installed on the modular coils, TF coils, and PF coils. Saddle loops installed on the vacuum vessel. Rogowski loops. Integrator, digitizer, and data acquisition for one Rogowski loop.	Design: 95% complete. 95% of parts delivered. Flux loops installed on vacuum vessel, modular & TF coils; Rogowski coils installed on vacuum vessel.
<u>Visible TV camera</u> : Delivery of one Fast visible TV camera system (based on existing equipment).	Design: Not started. No components delivered.
<u>Electron-beam mapping</u> : Installation of electron-beam mapping equipment including probe drive with an electron gun at its tip, fluorescent detector which intercepts the electron beam, and a high-resolution CCD camera to detect the light from the detector. Existing components will be used to the extent possible	Design: Not started. No components delivered or installed.

4.4 Electrical Power Systems (WBS 4)

This system consisted of the supply and delivery of all AC and DC electrical power to NCSX equipment, and equipment control and protection systems. MIE scope dealt with all electrical power system capabilities required for initial operation, including design, component fabrication, assembly, and installation activities, system level commissioning, and testing. Existing AC systems were refurbished through General Plant Project (GPP) projects. MIE scope and construction status at the end of the project are listed in Table 10.

Table 10: Electric Power System Scope

MIE Project & GPP Scope	Status at Closeout
Provide auxiliary AC power systems and experimental AC Power Systems.	Design 80% complete. Fabrication 45% complete (GPP work). Installation 45% complete (GPP work).
Provide refurbished AC/DC Convertors required for initial operation.	Design 70% complete. Procurement 0% complete. Refurbishment 0% complete.
Provide, refurbishing as needed, cabling and other DC components required to feed the NCSX machine from the existing C-Site rectifiers.	Design 35% complete. Fabrication 0% complete. Installation 0% complete.
Provide control and protection systems including electrical interlocks, Kirk key interlocks; real time Control systems, instrumentation systems, and coil protection systems	Design 15% complete. Fabrication 0% complete. Installation 0% complete.
Perform systems testing	Not Started.

4.5 Central Instrumentation, Controls, & Data Acquisition (WBS 5)

This system consisted of equipment and software that would have provided central computing, control, and synchronization for NCSX. Components interfaced with the subsystem's local instrumentation and controls (I&C) and allowed for control and monitoring of NCSX experiments from the control room, and included analysis and display of the data. Subsystems included: network & fiber infrastructure; central I&C; data acquisition and facility computing; facility timing and synchronization; real time control; central safety & interlocks; and control room. Project scope and construction status at the end of the project are listed in Table 11.

Table 11: Central Instrumentation, Controls, and Data Acquisition Scope

MIE Project Scope	Status at Closeout
Provide and install network & fiber infrastructure systems with common backbone for all data acquisition, and I&C communications.	Design 10% complete. Fabrication 0% complete. Installation 0% complete.
Provide and install integrated control of NCSX through supervisory control and a common user interface to selected engineering subsystems and diagnostics instruments. It will provide process control and monitoring functions, inter-process synchronization, operator displays, alarm management, and historical trending. It will be designed using the Experimental Physics and Industrial Control System (EPICS).	Design 5% complete. Fabrication 0% complete. Installation 0% complete.
Provide and install a software structure to collect, catalog, and manage experimental results for analysis and subsequent retrieval. The design will use the MIT-developed MDSplus software for data acquisition, data archiving and display.	Design 5% complete. Fabrication 0% complete. Installation 0% complete.
Provide and install a timing & synchronization system sufficient to synchronize the equipment and computers used for achieving the MIE Project requirements.	Design 10% complete. Fabrication 0% complete. Installation 0% complete.
Provide and install a PC-oriented, LabVIEW-like system to produce synchronized, open-loop power supply commands and gas injection commands. The system will also control a few gas delivery valves.	Design 5% complete. Fabrication 0% complete. Installation 0% complete.
Provide and install a central safety and interlock system Provide a limited CSIS, sufficient to achieve safe operation of the NCSX device.	Design 3% complete. Fabrication 0% complete. Installation 0% complete.

4.6 Facility Systems (WBS 6)

Facility Systems consisted of the following subsystems which support operation: water cooling; cryogenics; air system utilities; vacuum vessel heating and cooling. Project scope and construction status at the end of the project are listed in Table 12.

Table 12: Facility Systems Scope

MIE Project Scope	Status at Closeout
Cooling water: Provide required cooling water for vacuum pumping system	Design 5% complete. Fabrication 0% complete.
LN2 supply: Provide liquid nitrogen supply for coil and cryostat cooling consistent with CD-4 requirements	Design 10% complete. Fabrication 0% complete. Contract with Bagley Assoc for LN2 delivery system (WBS-621) and cooling of structures within cryostat (WBS-623) were underway in May 2008. Contract was terminated prior to completion of any design reviews.
Cryogenic system design: Establish requirements and system architecture for entire LN2 feed system including in-cryostat LN2 distribution system (WBS 161).	Design 70% complete. Fabrication 0% complete. Design of the in-cryostat LN2 distribution (WBS-161) for cooling of coils was well under way (successful PDR on 6/5/08).
Cryogenic system construction: Provide LN2 cooling system based on that constructed for the coil test facility (CTF).	Design 5% complete. Fabrication 0% complete. Contract with Bagley Associates for pressurized, circulating LN2 system delivery (WBS 622) was underway. Contract was terminated prior to completion of any design reviews.
Provide a vent for the vacuum vessel pumping system.	Design 5% complete. Fabrication 0% complete.
Vacuum vessel 150 C bakeout: Provide a system to force 150-deg-C heated air through the vacuum vessel heating and cooling tubes.	Design 5% complete. Fabrication 0% complete.

4.7 Test Cell Preparation & Machine Assembly (WBS 7)

This work consisted of engineering and field labor to prepare the test cell and install the stellarator core systems, including trial machine assembly in which the three field period assemblies would be joined together to form the torus (Figure 31), followed by installation of PF coils, remaining trim and TF coils, toroidal spacers, coil services, and cryostat. Design and fabrication of special machine assembly tools and equipment were included in this work. Project scope and construction status at the end of the project are listed in Figure 31. Schematics of the machine and services configurations in the test cell are illustrated in Figure 32 and Figure 33, respectively.

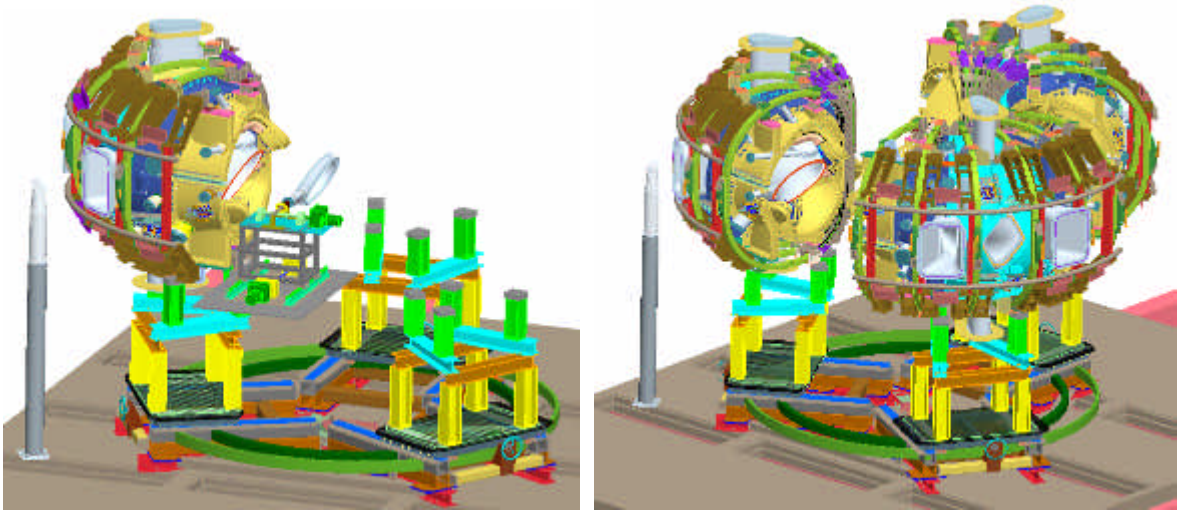

Figure 31: Schematics illustrating base structure, retractable FPA carts, and machine assembly.

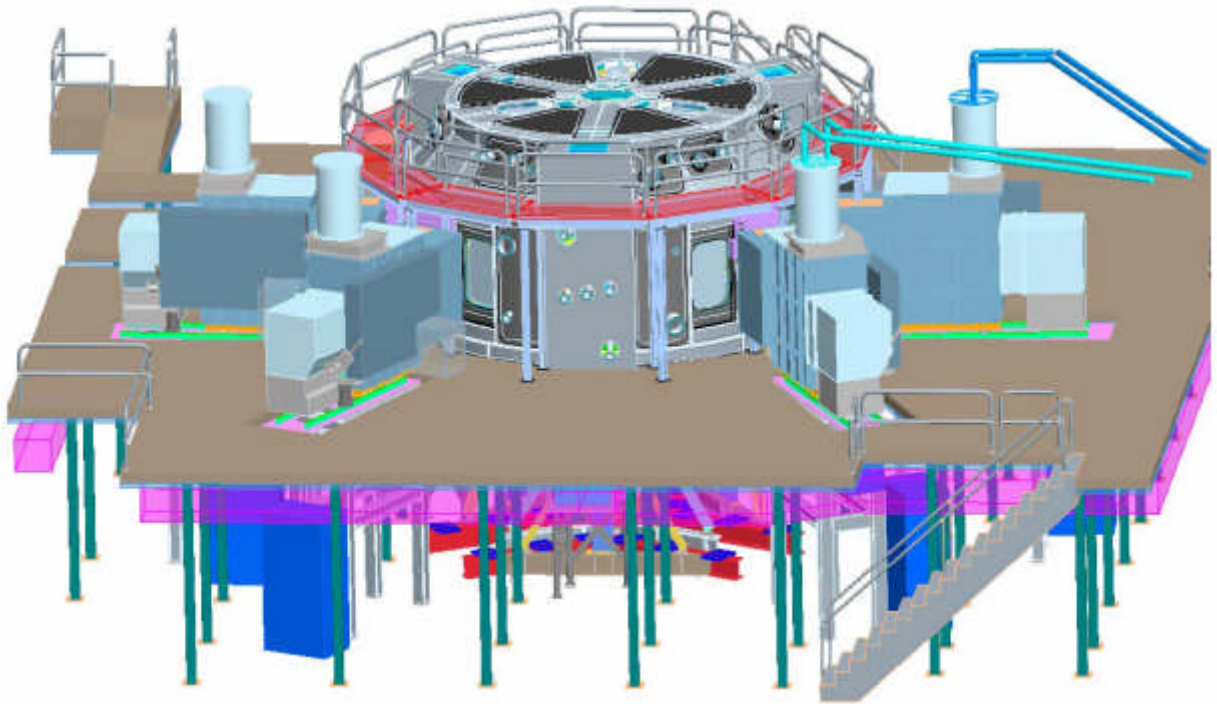

Figure 32: Schematic depicting NCSX Test Cell configuration.

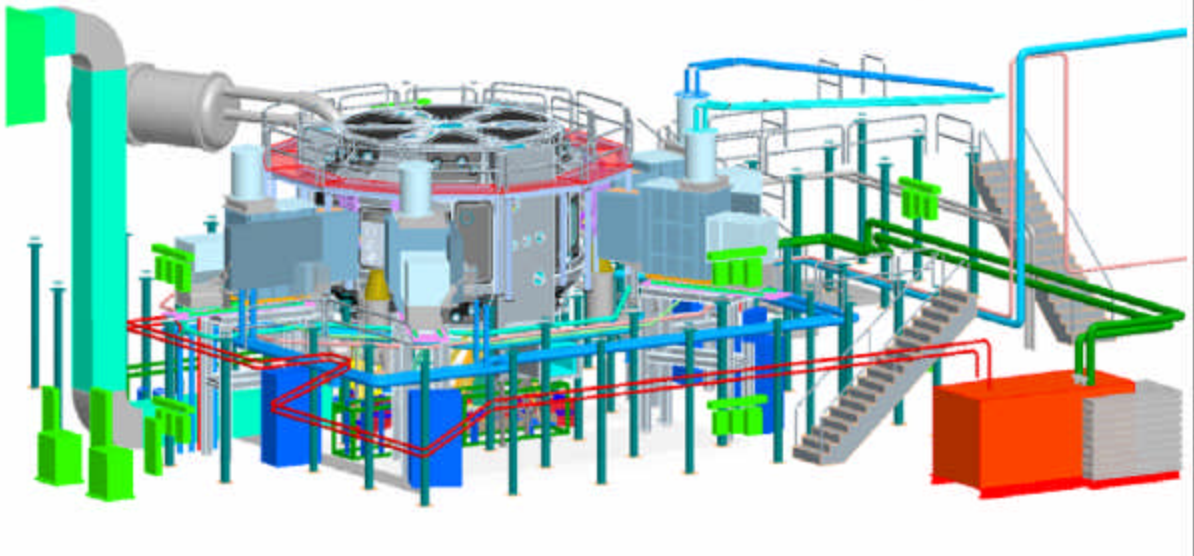

Figure 33: Schematic depicting the full service arrangement around machine core.

Table 13: Test Cell Preparation and Machine Assembly Scope

MIE Project Scope	Status at Closeout
Design and fabricate a platform around the NCSX device, in support of various diagnostics and systems required for operation.	Design: 80% complete Materials: 50% ordered & received Fabrication: 10% complete
Perform final assembly of the stellarator core, specifically: level machine base plate and support columns; install machine platform, lighting, fire detection/suppression systems, cryostat, PF coils, pumps; support pump down and vacuum leak testing.	Not started.
Design and fabricate tooling and fixtures for machine assembly including the base support structure used during assembly and constructability analyses.	Design: Models 75% complete; drawings not started. Analyses not started. Fabrication not started.

4.8 Technical Management & Support

Project Physics

This work included the definition of the project physics requirements and documenting them in the NCSX Project General Requirements Document (GRD).

Project Engineering

This work included risk management, project planning including implementing the PPPL work planning program, and the implementation of the PPPL Integrated Safety Management (ISM) program. Responsible Line Managers (RLMs) were responsible for managing design and procurement, on-site fabrication and assembly, and the design, fabrication, and assembly of ancillary, facility, and electrical systems.

System Engineering

This work included requirements management, design verification, including a program for systematic design reviews, configuration management and change control, including processing of Requests for Deviations (RFDs), Engineering Change Proposals (ECPs), and Engineering Change Notices (ECNs), and interface control, document control, and training project personnel in project plans, procedures, and practices.

Design Integration

This work included configuration development and integration support for all design and construction activities, design reviews, the computer aided design (CAD) database of project models and drawings, reviewing and promoting CAD models and drawings, establishing Intralink procedures and privileges, and providing support to the metrology and dimensional control efforts by analyzing metrology data in conjunction with CAD models of the parts and assemblies. During project closeout, a final review of the NCSX device was made to document configuration and interface issues and to identify design activities that would be needed, in the event of revisiting the NCSX design if future developments in the fusion program warrant it. Special emphases were placed on documenting the cryostat design, which was still in the design process prior to project termination, as it had significant integration impacts on interfacing components. Where cryostat-interfacing subsystems were still in design and time allowed changes, subsystems were altered to allow proper interface with the cryostat. When design changes were too involved, the expected cryostat imposed subsystem changes were documented. System component changes were reviewed by the effected WBS job managers. Other subsystems still in the design stage at project termination that received attention during closeout included the coil electrical services, the neutral beam transition duct (Figure 30), diagnostic ports and the pumping duct. Auxiliary systems and facilities issues brought about through the integration of the device core with the updated cryostat were also reviewed and documented.

System analysis / Technical Assurance

This work included establishing structural and cryogenic design criteria, performing systems-level structural and electromagnetic studies, establishing dimensional accuracy requirements for coil systems based on field error considerations, analyzing field errors, and managing field error budgets for as-designed conditions, out-of-tolerance conditions, eddy currents, and magnetic materials. It also included the disposition of nonconformance reports (NCRs), providing analysis support to the metrology and dimensional control efforts for troubleshooting problems as well as for production activities, analyzing options for optimally aligning modular coils based on physical and magnetic measurements, performing global analyses which are outside the scope of individual subsystems, and independently assessing design adequacy and risks for critical systems and design features. Analyses included electromagnetic calculations to determine coil inductances, fields, and forces, and global structural modeling to determine overall structural behavior, mechanical interface loads, and operating limits.

Dimensional Control Coordination

This work included support of design and construction activities in the realization of dimensional accuracy requirements by developing strategies and procedures for dimensional control and supporting their implementation.

Plant Design

This work included allocating space within the NCSX Test Cell and adjacent areas, and developing models and drawings to define the routing and location of equipment in the Test Cell.

Integrated System Testing

This work covered the planning, document preparation, and execution of the NCSX integrated system testing and startup activities, through the generation of the first plasma. Work was documented in a draft *NCSX Safe Startup & Control Plan*. The development and completion of the sub-system preoperational tests procedures were the responsibility of the individual sub-system WBS managers, and were detailed in the specific WBS work elements.

Closeout Documentation

This task includes documentation of all work, both performed and remaining at the time of project termination. This information will be of critical value if NCSX construction is restarted, or if another device of this type is undertaken in the future. A Closeout Note was prepared for each job that was in process at the time of NCSX cancellation or was

completed as part of the project closeout. Closeout Notes for jobs already completed and/or closed prior to cancellation, were generated on a case-by-case basis to document information that was not captured in other project documents, such as lessons learned and engineering solutions to problems that were encountered. Each closeout note included the following elements: job scope; status of work completed at the time of closeout; definition of key interfaces and any changes anticipated at time of closeout; and specifications, schematics, process & instrumentation diagrams, models, drawings, analyses, testing summaries, costs, narratives of remaining work, lessons learned, and a conclusion. Manuscripts for archival journal publication were also prepared.

Equipment Disposition

This job included the safe and orderly disassembly of NCSX construction facilities at PPPL and the disposition of equipment. The major components of the NCSX – the vacuum vessel, modular coils, TF coils, diagnostics, and their associated ancillary components, assembly fixtures, rigging, and tooling – were inventoried and stored in and under the test cell that had been prepared for NCSX (Appendix L). They can be readily retrieved in the event of a project restart at some later date. The modular coil autoclave was also stored at PPPL. The modular coil winding rooms and test cryostat were salvaged.

5. PROJECT MANAGEMENT

The NCSX Project was executed in compliance with DOE Order 413.3, *Program and Project Management for the Acquisition of Capital Assets*. An Integrated Project Team (IPT) was formed and led by the NCSX Federal Project Director to implement and achieve the overall project objectives and goals. The NCSX IPT consisted of the Federal Project Director, OFES NCSX Program Manager, OFES Stellarator Program Manager, Professional from the SC Office of Project Assessment, Laboratory Project Manager and Deputy Project Manager, Project Quality Assurance Engineer, Project Controls Manager, PPPL ES&H Manager, and PPPL Procurement Manager. Tasks were organized around a work breakdown structure (WBS, Table 14). A WBS dictionary has been archived at http://ncsx.pppl.gov/SystemsEngineering/WBS/WBS_index.htm. The WBS was further subdivided into jobs, each assigned to specific Job Manager who was responsible and accountable for accomplishing the scope of the work, as defined, with established schedule and cost targets. There were sixty-four active jobs at the time of the project cancellation. The vehicle for documenting and authorizing work was the Work Approval Form (WAF). Each WAF formally documented the approval and acceptance of the statement of work, deliverables and milestones, cost, schedule, design, fabrication and assembly labor, materials and supplies, a standardized basis for the cost estimate, identification of risks, and

designation of the design maturity and complexity of the work at a given time. The complete project organization, along with individual roles, responsibilities, authorities, and accountability were documented in a Project Execution Plan. The project followed a methodical process for quantifying cost and schedule contingency through the use of probabilistic calculations accounting for identified risks, and WBS design maturity and complexity. Increased emphasis on the use of a complete and up-to-date project risk registry occurred as the project evolved (Appendix G).

A resource-loaded, integrated, baseline project schedule was developed and implemented using Primavera project management software. The schedule was based on deliverables and/or tasks identified by the job managers in their WAFs, with labor resources assigned to each tasks, with Institutional overhead and labor rates. The integrated project schedule was optimized focusing on the critical path (*e.g.*, use of 2 shift operations, floor space for assembly tasks, crane utilization studies), maximizing free float of non-critical path activities, front end loading system designs, fitting within OFES budget guidance, and mitigating the highest risks. When needed, contingency budget authority was to be created by delaying low-risk/large float activities. Task durations were based on realistic resource loadings and crew sizes, and were logically linked (2,170 tasks, 2700 links, 2900 individual resource loadings).

Table 14: NCSX Work Breakdown Structure

WBS-1	Stellarator Core Systems
WBS-2	Auxiliary Systems
WBS-3	Diagnostics Systems
WBS-4	Electrical Power Systems
WBS-5	Central Controls & Computing Systems
WBS-6	Facility Systems
WBS-7	Test Cell Preparation & Machine Assembly
WBS-8	Project Oversight & Support

Progress relative to the performance baseline was assessed with an earned value management system. Progress was reported in: (1) weekly meetings with the Federal Project Director; (2) weekly meetings with the PPPL Director’s Office; (3) weekly teleconferences with the OFES Program Manager; (4) monthly reviews by the PPPL Director and PU Dean for Research; (5) monthly cost and schedule reports to DOE; (6)

semi-annual cost and schedule reviews by SC Office of Project Assessment; (7) three separate project reviews by an external independent review committee established by PU in 2007. A chronology of major external project reviews is provided in Appendix K.

Quality assurance was achieved by executing a plan that included procedures, policies, inspections, design reviews, support of procurements. Compliance-based and performance-based audits of the project and its associated plans and procedures were performed to assure that the requirements of the DOE Order on Quality Assurance, 414.1A were met. The Defense Management Contract Agency (DCMA) augmented PPPL QA organization by providing written audit reports.

6. COST & SCHEDULE PERFORMANCE

Unsatisfactory cost and schedule performance relative to the approved baseline was reported to OFES beginning with the 3QFY07 quarterly report. Bottoms-up cost estimates were performed in June 2007 through March 2008 which were part of the draft baseline change proposal that was prepared by the Project and reviewed by DOE in April 2008.

6.1 Cost & Schedule of Work Accomplished

MIE construction work ended in September 2008. Percentages of completion are listed in Tables 15-16. Closeout specific tasks that were not part of the 2005 MIE Project baseline, such as additional documentation and materiel disposition, are not included in these tables. Status of the Project tasks at the time of closeout is summarized in Section 4, with details archived at: http://ncsx.pppl.gov/NCSX_Engineering/CloseOut_Documentation/CloseoutDoc_index.htm.

Table 15: Percentages of budget spent (actual costs/approved 2005 TEC) and work completed at the time of Project work termination.

Spent Capital Budget	93%
Overall Project	62%
R&D	98%
Design	75%
Procurements	70%
Fabrication & Assembly	51%

Table 16: Breakdown of project completion status at the time of termination

Project Completion Analysis (through Sept 2008)							
		<u>Design</u>	<u>R&D</u>	<u>Procure</u>	<u>Fab & Assy</u>	<u>Mgt & Oversight</u>	<u>TOTAL</u>
12 Vacuum Vessel	<u>Spent (\$k)</u>	<u>\$1,641</u>	<u>\$1,787</u>	<u>\$6,325</u>	<u>\$132</u>		<u>\$9,885</u>
	Total (\$k)	\$1,864	\$1,787	\$7,305	\$216		\$11,172
13 Conventional Coils	<u>Spent (\$k)</u>	<u>\$1,561</u>	<u>\$0</u>	<u>\$2,669</u>	<u>\$536</u>		<u>\$4,766</u>
	Total (\$k)	\$1,665	\$0	\$5,670	\$751		\$8,086
14 Modular Coils	<u>Spent (\$k)</u>	<u>\$6,463</u>	<u>\$5,458</u>	<u>\$13,513</u>	<u>\$14,870</u>		<u>\$40,304</u>
	Total (\$k)	\$6,461	\$5,456	\$13,963	\$14,855		\$40,735
15 Structures	<u>Spent (\$k)</u>	<u>\$814</u>	<u>\$0</u>	<u>\$0</u>	<u>\$0</u>		<u>\$814</u>
	Total (\$k)	\$814	\$0	\$1,252	\$12		\$2,078
16 Coil Services	<u>Spent (\$k)</u>	<u>\$139</u>	<u>\$0</u>	<u>\$0</u>	<u>\$0</u>		<u>\$139</u>
	Total (\$k)	\$392	\$24	\$493	\$179		\$1,088
17 Cryostat & Base Support Structure	<u>Spent (\$k)</u>	<u>\$715</u>	<u>\$0</u>	<u>\$0</u>	<u>\$0</u>		<u>\$715</u>
	Total (\$k)	\$1,206	\$0	\$780	\$0		\$1,986
18 Field Period Assembly	<u>Spent (\$k)</u>	<u>\$1,700</u>	<u>\$0</u>	<u>\$57</u>	<u>\$6,798</u>		<u>\$8,555</u>
	Total (\$k)	\$2,520	\$0	\$362	\$17,070		\$19,952
1 Stellarator Core	<u>Spent (\$k)</u>	<u>\$13,033</u>	<u>\$7,245</u>	<u>\$22,564</u>	<u>\$22,336</u>		<u>\$65,178</u>
	Total (\$k)	<u>\$14,922</u>	<u>\$7,267</u>	<u>\$29,825</u>	<u>\$33,083</u>		<u>\$85,097</u>
		87%	100%	76%	68%		77%
2 Auxiliary Systems	<u>Spent (\$k)</u>	<u>\$348</u>	<u>\$0</u>	<u>\$0</u>	<u>\$0</u>		<u>\$348</u>
	Total (\$k)	<u>\$784</u>	<u>\$0</u>	<u>\$215</u>	<u>\$366</u>		<u>\$1,365</u>
		44%	0%	0%	0%		25%
3 Diagnostics	<u>Spent (\$k)</u>	<u>\$720</u>	<u>\$0</u>	<u>\$18</u>	<u>\$565</u>		<u>\$1,303</u>
	Total (\$k)	<u>\$938</u>	<u>\$0</u>	<u>\$68</u>	<u>\$934</u>		<u>\$1,940</u>
		77%	0%	26%	60%		67%
4 Electrical Power Systems	<u>Spent (\$k)</u>	<u>\$656</u>	<u>\$0</u>	<u>\$0</u>	<u>\$0</u>		<u>\$656</u>
	Total (\$k)	<u>\$1,369</u>	<u>\$0</u>	<u>\$216</u>	<u>\$1,749</u>		<u>\$3,334</u>
		48%	0%	0%	0%		20%
5 I&C Systems	<u>Spent (\$k)</u>	<u>\$50</u>	<u>\$0</u>	<u>\$0</u>	<u>\$0</u>		<u>\$50</u>
	Total (\$k)	<u>\$818</u>	<u>\$0</u>	<u>\$624</u>	<u>\$689</u>		<u>\$2,131</u>
		6%	0%	0%	0%		2%
6 Facility Systems	<u>Spent (\$k)</u>	<u>\$66</u>	<u>\$0</u>	<u>\$0</u>	<u>\$0</u>		<u>\$66</u>
	Total (\$k)	<u>\$896</u>	<u>\$104</u>	<u>\$722</u>	<u>\$726</u>		<u>\$2,448</u>
		7%	0%	0%	0%		3%
7 Test Cell Prep & Machine Assy	<u>Spent (\$k)</u>	<u>\$0</u>	<u>\$0</u>	<u>\$0</u>	<u>\$763</u>		<u>\$763</u>
	Total (\$k)	<u>\$0</u>	<u>\$0</u>	<u>\$367</u>	<u>\$8,919</u>		<u>\$9,286</u>
		-	-	-	9%		8%
Sub-TOTAL	<u>Spent (\$k)</u>	<u>\$14,873</u>	<u>\$7,245</u>	<u>\$22,582</u>	<u>\$23,664</u>		<u>\$68,364</u>
	Total (\$k)	<u>\$19,727</u>	<u>\$7,371</u>	<u>\$32,037</u>	<u>\$46,466</u>		<u>\$105,601</u>
	% complete	75%	98%	70%	51%		65%
19 Stellarator Core Mgmt & Integration	<u>Spent (\$k)</u>	<u>\$0</u>	<u>\$0</u>	<u>\$0</u>	<u>\$0</u>	<u>\$2,601</u>	<u>\$2,601</u>
	Total (\$k)	\$0	\$0	\$0	\$0	\$4,572	\$4,572
8 Project management & Engr	<u>Spent (\$k)</u>	<u>\$0</u>	<u>\$0</u>	<u>\$0</u>	<u>\$0</u>	<u>\$14,954</u>	<u>\$14,954</u>
	Total (\$k)	\$0	\$0	\$0	\$0	\$28,007	\$28,007
Grand Total	<u>Spent (\$k)</u>	<u>\$14,873</u>	<u>\$7,245</u>	<u>\$22,582</u>	<u>\$23,664</u>	<u>\$17,555</u>	<u>\$85,919</u>
	Total (\$k)	<u>\$19,727</u>	<u>\$7,371</u>	<u>\$32,037</u>	<u>\$46,466</u>	<u>\$32,579</u>	<u>\$138,180</u>
	% complete	75%	98%	70%	51%		62%

6.2 Cost & Schedule Estimates to Complete Unfinished Work

A bottoms-up cost estimate for the remaining work was performed in August 2007 and reviewed by DOE SC (Appendix K). This estimate was subsequently revised in March 2008, and submitted to DOE in March 2008 as part of a draft baseline change proposal (http://ncsx.pppl.gov/Reviews/FY08/BCP_2008/BCP_08_index.html), reviewed by DOE in April 2008. Cost estimates were performed with a formal and consistent basis of estimate (Figure 34), and independently reviewed by the PPPL Associate Director for Engineering and Infrastructure, and by an external review committee organized by Princeton University (PU). For much of the first-of-a-kind subsystems associated with the stellarator core, the basis of estimate evolved over the course of the project from engineering judgment to actual NCSX experience.

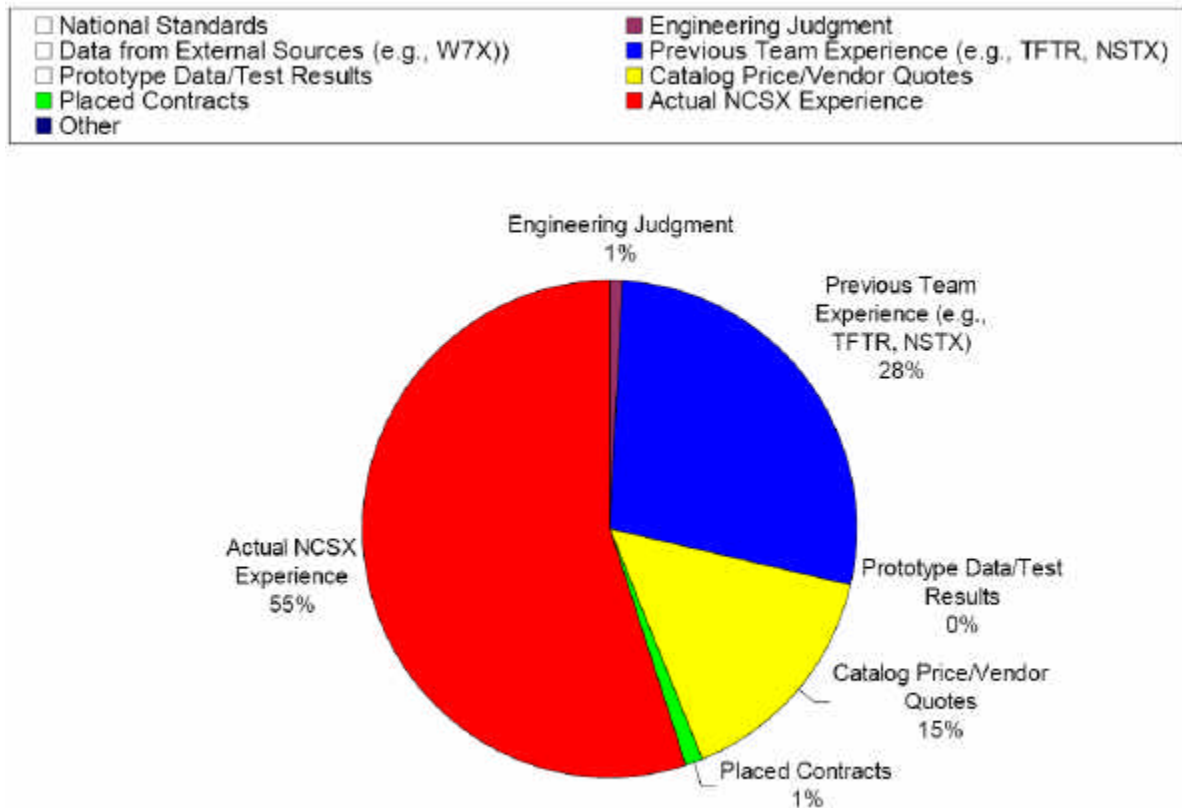

Figure 34: Basis of cost estimate in March 2008

6.3 Final Estimate at Completion

In this section, a final estimate to complete (ETC) at the time of closeout is documented. This ETC is based upon the March 2008 draft BCP modified after;

- 1) accounting for all subsequent earned value and actual costs incurred by the project for non-closeout activities;
- 2) including modest corrections for ETC omissions and errors that were communicated to OFES on May 1, 2008;
- 3) revising the bottoms-up ETC for field period assembly, accounting for actual experience since April 2008;
- 4) revising the ETC for the cryostat and cryogenic systems, accounting for several conceptual design activities that occurred in April-May 2008; and
- 5) performing a final, risk-based contingency estimate, accounting for risks that were retired since April 2008.

Results are presented in Tables 17-18. Costs are based upon escalated dollars while closeout specific tasks that were not part of the 2005 MIE Project baseline, such as additional documentation and materiel disposition, are not included. The ETC schedule was consistent with OFES budget guidance in 2008 prior to termination of the project. The critical path continues to pass through field period assembly, final machine assembly and start-up operations. Major procurement of components as well as ancillary system had ample schedule margin (months off the critical path). Contingency was calculated using the NCSX risk-based probabilistic model results (as calculated for the March 2008 draft BCP) and, factoring in changes in risk reduction, design maturity since the March 2008 draft BCP and work accomplished since March 2008.

Table 17: Summary of the estimate to complete (ETC) for remaining work

Actual costs at project closeout	\$86.1M
Cost estimate to complete	\$55.0M
Cost Contingency	\$18.3M
Estimate at Completion	\$159.4M
Schedule estimate to complete	40-mo.
Schedule Contingency	15-mo.

Table 18: Details of the estimate to complete (ETC) for remaining work

NCSX MIE Project EAC Budget					
WBS		Proposed Baseline EAC MARCH 2008	ETC (assumed 2/1/09 re-start)	Updated EAC January 2009	Change
12	Vacuum Vessel	\$11,172	1,389	\$11,268	\$96
13	Conventional Coils	\$8,086	3,164	\$7,941	-\$145
14	Modular Coils	\$40,735	804	\$41,117	\$383
15	Structures	\$2,078	1,290	\$2,105	\$27
16	Coil Services	\$1,088	860	\$999	-\$89
17	Cryostat & Base Support Structure	\$1,986	2,163	\$2,878	\$892
18	Field Period Assembly	\$19,952	11,622	\$20,199	\$247
19	Stellarator Core Mgmt & Integr	\$4,572	1,750	\$4,364	-\$208
1	Stellarator Core	\$89,668	23,040	\$90,871	\$1,203
2	Auxiliary Systems	\$1,366	1,022	\$1,367	\$1
3	Diagnostics	\$1,942	639	\$1,943	\$1
4	Electrical Power Systems	\$3,334	2,764	\$3,419	\$85
5	I&C Systems	\$2,132	2,082	\$2,131	\$0
6	Facility Systems	\$2,447	3,777	\$3,842	\$1,395
7	Test Cell Prep & Machine Assy	\$9,285	9,018	\$9,781	\$496
81	Project Management and Oversight	\$8,839	3,846	\$8,866	\$27
82	Project Engineering	\$14,107	6,399	\$13,776	-\$331
84	Project Physics	\$470		\$470	\$0
85	Integrated Systems Testing	\$795	796	\$800	\$5
8	Project Oversight & Support	\$24,211	11,041	\$23,912	-\$299
Allocations		\$3,720	1,661	\$3,814	\$94
Subtotal		\$138,104	55,043	\$141,080	\$2,976
Contingency		\$22,410	18,307	\$18,307	-\$4,103
DCMA		\$75		\$75	\$0
TOTAL		\$160,589		\$159,462	-\$1,127
	Planned Finish =	Jan-12		May-12	
	CD-4 =	Aug-13		Sep-13	
	Schedule Contingency =	19 mo.		15 mo.	
Termination Scope NEW MIE not included above					
	NCSX Equip Disposition & Facility Restoration			\$566	
	NCSX Documentation for closeout			\$543	

7. ENVIRONMENT, SAFETY, & HEALTH

The NCSX Project pro-actively strove for a zero incident safety record. Work was performed in accordance with PPPL Engineering and ES&H Procedures and Directives and best safety practices, which included: Integrated Safety Management (ISM), the National Environmental Policy Act (NEPA), job hazard analyses, work planning, installation and safety procedures, pre-job and post-job briefings, and training. The Project regularly used the PPPL Safety Certification System which provided a formalized, standardized means of assuring independent review and authorization of high hazard operations. The PPPL ES&H Executive Board (ES&H/EB) appointed an Activity Certification Committee (ACC) for NCSX that conducted safety reviews, recommend issuance or denial of Safety Certificates, recommended to the ES&H/EB any necessary special conditions or constraints on which the issuance of Safety Certificates should be based. ACC reviews were conducted for modular coil winding, casting, electrical and cryogenic testing, welding, and assembly operations. In addition to formal review, the PPPL ISM system was reinforced with regular toolbox meetings involving management, supervisors, and staff to discuss relevant safety topics such as working hazard analysis, personal protective equipment, electrical systems, welding, hoisting and rigging, ladders, ergonomics, and emergency management. Further details of NCSX ES&H program are at:

http://ncsx.pppl.gov/NCSX_Engineering/ES&H/index_ESH.htm.

DOE conducted a re-evaluation of PPPL ISM in 2006 with particular emphasis on services and activities that supported NCSX. In their outbrief, reviewers noted that NCSX: post-job briefings were effective; management actively solicited input from workers to improve safety and improve operations; management and support staff maintained a day-to-day awareness of activities by walkthroughs, observations of work, interactions with employees, as well as leading pre-and post-job briefings. An Environmental Assessment (EA) was completed for NCSX in 2002, and following an independent external review, DOE issued a Finding of No Significant Impact in October 2002.

Overall ES&H performance on NCSX was excellent. From the beginning of the MIE Project in April 2003 through September 30, 2008. PPPL and ORNL personnel worked a total of 480,000 hours on the project without a single away from work injury or Days Away/Restricted Work/Job Transfer (DART) incident, and with one OSHA recordable incident. This performance was recognized for three consecutive years by the State of New Jersey with their Commissioner of Labor & Workforce Development Award to the NCSX Project.

8. KEY LESSONS LEARNED

Given the magnitude of the cost and schedule variances that occurred on the NCSX, it is important to identify underlying issues and lessons learned that may be applied to future projects. Systemic issues and key lessons are provided in this Section. Lessons specific to an individual WBS level were documented elsewhere in the closeout notes prepared by NCSX Job Managers (http://ncsx.pppl.gov/NCSX_Engineering/CloseOut_Documentation/CloseoutDoc_index.htm).

8.1 DOE Perspective

In assessing the history of the NCSX project, the following observations have been made:

1. Defining the Original Project Budget in an Unconstrained Manner

In the late 1990s, the developing US stellarator program assessed the potential of a device that would demonstrate compactness, high beta, low recirculating power, and low disruptivity. In doing so, a three period quasi-axisymmetric stellarator was selected as the design configuration that would be consistent with the properties sought by the NCSX team. A conceptual configuration of the machine was developed. *During the developmental period leading up to the CD-1 (approval of alternative selection and cost range), the project team was provided budgetary guidance that the NCSX Project should target a TEC of approximately \$70M.* It is unlikely that the conceptual design was adequately developed to address this budgetary constraint with any degree of cost certainty.

2. Insufficient Design Development at CD-2 Baseline

The design of NCSX at the time of CD-2 (approval of performance baseline) focused on procurement of major components (VVSA, MCWF, conductor), but was not sufficiently developed in other areas to provide accurate cost estimates and minimize fabrication and assembly risk. *As complexities developed in major component design and procurement, the focus on these issues took priority and did not allow adequate design development of other project systems.*

3. Lack of Realistic Estimates During Fabrication/Construction

As problems developed during the construction phase, the Project focused on critical path issues and resolved them successfully, although consistently at increased cost. Many design tasks on near critical or non-critical systems and components were delayed. The costs were higher across the board – in design, procurement, fabrication, and assembly.

The implications of this on the later project phases and on the total project cost was not adequately and accurately estimated by the project team.

4. DOE Directed Re-baseline: Effects of a Constrained Budget Profile

In early 2005, the OFES Program Office directed the NCSX team to rebaseline the project with a “flat budget” profile in lieu of ramping up as originally planned. The re-planning supported critical path work and near critical path work (design). However, due to cost growth within all elements of the project, *only* the critical path work could be supported, and therefore, important design work in other systems and tasks was deferred. As a result, *the accuracy of semi annual ETC exercises was hampered by the lack of design information and the ability to effectively identify risk and fully analyze contingency needs for the remaining work.*

5. The High Cost of Tolerance in Manufacturing and Component Assembly

Complex critical components must be held to very high manufacturing and assembly tolerances to maintain stellarator symmetry. For example, tolerances are as small as 0.020 inches on large components such as the modular coil’s conductor position. No fusion devices have been built to date with these extreme requirements. It was soon realized *that high tolerances and sophisticated geometries were significant cost and schedule drivers for this project, much more than originally estimated. In addition, expected learning curve efficiencies were not realized.* Even the vendors, who have a history of complex fabrication, underestimated the cost of this requirement. Although the Project relaxed tolerances in areas that were not required, this issue has had a cost impact to the work performed, and will continue to add risk to the assembly work that lies ahead.

6. Incorporating Developmental Trials and Prototyping

The Project incorporated manufacturing/developmental trials and prototyping. Most notable were manufacturing trials for modular coil castings and vacuum vessel sub assemblies. However, there are other areas that would have benefited by performing more of this activity. For example, the modular coil winding forms did not undergo full prototyping. That is, the machining phase was omitted which later proved to be the most difficult part of winding form production. Also, a full scale winding trial versus a reduced scale winding trial (*i.e.*, the twisted race track coil) would have been beneficial in determining labor requirements, schedule and final part selection. *Developmental trials and prototyping may not reduce the overall cost of a project but rather make the project more predictable and help establish more accurate cost and schedule baselines.*

7. Possibility of Project Cancellation

The NCSX Project was advised by the Office of Science that the project must maintain the cost and schedule baseline or project cancellation was possible. These conditions lead to the NCSX Project Team, and PPPL management, to continue managing within a decaying baseline with no expectation for relief. *Estimates for remaining work continued to be based on a 'best case' scenario with continued reliance on learning curve expectations which never materialized, and only marginal contingency to resolve problems.* Re-planning exercises were frequently performed to support only near term (6 months ahead) needs.

8.2 Contractor Perspective

Underlying Issues

A lessons learned study was conducted by PPPL and PU to better understand issues that led to cost and schedule variances on NCSX and to establish corrective actions to prevent reoccurrence of similar problems in future projects. The following issues were identified:

1. Premature definition of the project cost and schedule when the project baseline was established at CD-2, due to the design, analysis, and R&D being insufficiently mature.
2. Underestimate of the implications of meeting the tolerance requirements of a complex three-dimensional structure.
3. Under-appreciation of the high risks associated with the application of cutting edge technologies.
4. Inadequate engineering staffing early in the project, leading to the need to develop “just in time” engineering solutions to technical problems that arose.
5. Lack of independent internal review of cost and schedule.
6. Loss of key experienced technical personnel to a higher-priority project.
7. Insufficient management for a project of this size and complexity.
8. Inadequate PPPL and PU oversight.
9. Inadequate communication with DOE.

As noted below, a concerted effort was made during the final year of the project to address these underlying issues. By the time of project cancellation, action plans to address these lessons learned and were in place and being implemented.

Lessons learned

1. Complete requisite R&D and designs prior to establishing a baseline.

The complex geometry and tight fabrication tolerances of NCSX created unique engineering and assembly challenges. R&D and design needs to be sufficiently completed to establish a sound technical basis for the cost and schedule estimates. To the extent that such tasks are still outstanding at the time a baseline is established, it poses a risk which must be recognized, quantified, and managed with risk acceptance/mitigation/transfer plans and with contingency management. The NCSX was a highly developmental project, which distinguished itself from most other DOE construction projects. The design was not at a PDR level, and assembly processes for many critical components, and more importantly, critical prototyping tasks (e.g., for construction and assembly of the vacuum vessel and modular coils) were still outstanding when the project was baselined in 2003. By 2007, the project had become better “calibrated” by its experience in meeting NCSX engineering challenges, which provided the basis for a more realistic estimate of costs and risks of the remaining work. However, at the time of project termination, not all of the design and prototyping had been completed (Table 15), resulting in considerable residual risks.

2. Implement rigorous, disciplined, and realistic cost estimating techniques early on.

The formality of estimating cost and schedule was insufficient during the early years of the project. It is important to realistically assess the uncertainties, their sources, and the prospects for reducing them. Subjective characterizations of “confidence” should be avoided. Comparison with previous similar experience can be misleading if it does not adequately take into account the special circumstances of a complex project like NCSX. For first-of-a-kind hardware, estimates need to realistically account for the process development time and effort associated with the initial fabrication, installation, and integration activities. Though often overlooked, similar considerations apply to design activities. While learning-curve improvements can reasonably be expected as activities move into production (for example, see Figure 19), it can be difficult to quantify the expected gains in advance. To improve rigor that was lacking in the original estimates, several improvements were implemented beginning in 2007 that should be adopted early on in future projects. They included a standardized basis of estimate (Figure 34) for each WAF, and having the Job Manager, the Responsible Line Manager, Project Manager and the PPPL Associate Director for Engineering and Infrastructure review and approve all cost and schedule changes, thus enforcing a uniform standard of realism documenting the commitment of all parties to meeting the proposed estimate. Reviewers also identified risks and opportunities associated with the job estimate as input to the risk registry. Lower level

milestones at approximately monthly intervals were identified for each job and tracked and statused by the engineering managers such that off-critical path tasks are also given greater visibility.

3. Conduct regular bottoms-up estimates to complete (ETC) to identify and address cost and schedule issues.

After the approval to start construction, the project did not perform thorough ETC updates on a regular basis. While attention was given to cost and schedule problems occurring in ongoing work, the ramifications for future work, especially assembly, were not adequately analyzed. The project was remiss in characterizing its December 2006 estimate as a “high-confidence” estimate, given its basis. Rather, a bottom-up analysis should have first been conducted for all remaining work, risks, and uncertainties. Large projects need to perform and report ETCs at regular intervals (*e.g.*, monthly top-down estimates at the management level, with more comprehensive bottoms-up estimates performed semi-annually). NCSX job estimates were extensively revised by all the job managers in 2007-08, incorporating new analyses and lessons learned. In particular, metrology and Title-III engineering experience in the fabrication of the modular coils and vacuum vessel were applied to assembly estimates. This resulted in a new, uniform format for developing NCSX cost estimates, designed to decrease the likelihood of missing sub-tasks in a cost estimate, and of elements being missed at the interface between jobs. Had these ETCs been performed on a regular basis, cost and schedule issues could have been recognized and dealt with sooner.

4. Develop and execute an effective risk management plan early on.

The use of formal risk and opportunity assessment techniques, based on a risk register and analysis of the tasks at the job level, is required to establish cost and schedule contingency needs. In support of the 2008 NCSX rebaselining effort, an external expert was brought in to augment and improve PPPL risk management capabilities to apply more quantitative approaches to transform the risks identified in the risk registry into contingency requirements, and to help distinguish cost estimation uncertainty from risk. An up-to-date risk registry including risk mitigation actions became a key project management tool. Most importantly, the Project Team became more skilled at recognizing the risks in the remaining work, quantifying them, and developing mitigation plans (Appendix G). In this regard, the experiences in component fabrication provided a much better understanding of the project risks than those that existed at the time the project baseline was approved. This late introduction of a rigorous risk analysis, however, resulted in a significant increase in cost and schedule rather late in the project cycle. This likely was a contributing factor in the decision to terminate NCSX.

5. Develop, maintain, and execute a staffing plan.

The NCSX benefitted from the many high-qualified, experienced staff assigned to the project. However, staffing levels were often inadequate to successfully execute the project due to several interconnected factors including: the underestimate of time and effort needed to complete a job; over-commitments of personnel, exacerbated by an incomplete or incorrect staffing plan which resulted in reluctance to request additional staff to maintain schedule; preferential commitment of resources to current critical path scope, cost overruns, and schedule delays at the expense of design and risk reduction for future scope; and the premature (relative to job completion) loss of critical personnel to the ITER Project, which was the highest facility construction priority of the DOE SC and OFES. This understaffing caused engineering efforts to fall behind, leading to the “just-in-time” engineering as an unintended consequence. Ultimately, the NCSX Project was held up for more than one year waiting for critical design tasks to be completed. The project eventually did develop a staffing plan that accounted for monthly assignments of specific individuals (*i.e.*, no near-term tasks performed by “TBDs”) for each WBS level-4 task, self-consistent with the resource-loaded schedule. Future projects should develop a staffing plan early on and execute the plan to help drive schedule and validate ETCs.

6. Recognize the cost and schedule implications of using high technology tools at or near their capability limits.

NCSX relied upon several state-of-the-art tools and techniques, such as three-dimensional computer-aided design modeling, electromagnetic and stress analyses of devices with complex 3-D magnetic fields, metrology, low-distortion welding, and casting and machining large, non-planar geometries. Capabilities selected for a project must be confirmed prior to establishing the cost and schedule baseline. Training and qualification certification standards also need to be included. To improve implementation times and usage estimates, other more experienced users of the technology should be consulted and/or recruited. All tools need to be validated before their use is required.

7. Develop strong ties with external resources in key technology areas, including those outside of your area of expertise.

Development of a first-of-its kind project such as NCSX requires the development of strong ties to external resources in industry and other laboratories to provide the specialized expertise in a diverse number of areas necessary. NCSX made extensive use of global external resources stretching from eastern Europe, throughout the U.S., and extending into to the east Asia. Industrial experts and consultants provided a great deal of input on manufacturing, materials, and processes.

In addition to consulting with suppliers, it is important to establish ties with other end users early on. For example, several of the NCSX key technical issues has been faced and resolved by others, often working in other scientific areas such as particle physics. Laboratory resources such as CERN LHC and the Max Planck W7-X projects provided expertise in metrology and low-distortion welding, but mostly after these problems arose relatively late during NCSX construction. This consistent tapping into external resources was a great benefit to NCSX, and should be emphasized in all projects because of its value in reducing development times and costs. Accessing experts in early stages, (*e.g.*, during design reviews – see below) can better help a project team identify, manage, and retire risks in advance, rather than dealing with them as surprises that emerge while on the critical path.

A rigorous design review procedure developed by PPPL was adopted by the project for peer, conceptual, preliminary, and final designs. There was no shortage of design reviews – a total of 102 separate reviews were conducted between 2003 and 2008 by 592 reviewers! The use of external organizations were minimal, however; approximately 84% of these reviewers were members of NCSX Project Team, 11% were from other departments at PPPL and ORNL Fusion Energy Division, while only 5% were from other external organizations. As the project evolved, there was a concerted effort to bring in external reviewers from the fusion community as well as from other disciplines (*e.g.*, particle accelerators, neutron spallation sources, cryogenic engineering, and high-magnetic field laboratories) which brought healthy fresh evaluation and constructive criticism at design reviews. In 2007, PU established an NCSX External Review Committee, composed of experts in project management and in the construction of stellarators and similar complex experimental facilities, to review the project progress and plans. These experts provided valuable advice and critical evaluation. Senior management should establish these external review committees during the early stages of a major project and use them on a regular basis.

8. Build a strong, effective project management organization early.

A strong, experienced, and cohesive project team with unambiguous roles, responsibilities, authority, and accountability is essential in executing these lessons learned, and in instilling a culture of personal accountability, with focus on driving schedule without compromising safety and quality. PU launched a concerted effort to strengthen NCSX project management, but it was late in the project and could not prevent the decision to cancel the Project. In future projects, adequate management staffing and systems must be put in place at the beginning. In the wake of NCSX, a concerted effort will be underway to develop and modify Lab-wide project management policies, procedures and plans, based on these lessons-learned. The formal cost estimating process used to develop the bottoms-

up ETC is being incorporated into PPPL policies and procedures. The current training budget for engineering will be augmented.

9. Communicate and act.

Throughout the Project, PPPL senior management was engaged. They reviewed project earned value reports in detail, drove value engineering and scope reductions to try to maintain contingency, and were heavily involved in preparations for reviews. There were frequent briefings for PSO and OFES. There were regular updates to SC, especially after the Project was placed on the SC Deputy Director's Watch List in 2006 when modular coil winding form delays and overruns were recognized. While the Federal Project Director did draw attention to a looming cost and schedule crisis at that time, another eleven months past until a bottoms-up ETC was performed to quantify the magnitude of the cost overruns and schedule delays. Unless major problems are promptly confronted and resolved, there is no real communication. PU senior management became actively involved beginning in 2007 and was a strong advocate of getting the "bad news" out fast, and insuring that it is not only communicated, but also effectively dealt with.

9. REFERENCE DOCUMENTS

Memorandum of Understanding between PPPL & ORNL for Collaboration on the NCSX & QPS Projects, Rev-0 (November 1998)

NCSX Acquisition Execution Plan, NCSX-PLAN-AEP (June 2002)

http://ncsx.pppl.gov/SystemsEngineering/Plans_Procedures/NCSX_Mgmt_Plans/AEP/NCSX-PLAN-AEP-00.pdf

NCSX Configuration Control Procedure, NCSX-PROC-002 Revision 3 (May 2006)

http://ncsx.pppl.gov/SystemsEngineering/Plans_Procedures/Procedures/PROC-002_ConfigurationControl/NCSX_PROC-002-03-Signed.pdf

NCSX Configuration Management Plan Rev-2, NCSX-PLAN-CMP-02 (May 2005)

http://ncsx.pppl.gov/SystemsEngineering/Plans_Procedures/NCSX_Mgmt_Plans/CMP/NCSX-PLAN-CMP-02-Signed.pdf

NCSX Data Management Plan Rev-4. NCSX-PLAN-DMP-04 (October 2006)

http://ncsx.pppl.gov/SystemsEngineering/Plans_Procedures/NCSX_Mgmt_Plans/SEMP/NCSX-PLAN-SEMP-00-Signed.pdf

NCSX Design Review Process, NCSX-PROC-010 Revision 1 (February 2006)

http://ncsx.pppl.gov/SystemsEngineering/Plans_Procedures/Procedures/PROC-010_DesignReviews/NCSX-PROC-010-01-Signed.pdf

NCSX Documents & Records Plan, NCSX-PLAN-DOC-04, (October 2006)

http://ncsx.pppl.gov/SystemsEngineering/Plans_Procedures/NCSX_Mgmt_Plans/DOC/NCSX-PLAN-DOC-04-Signed.pdf

NCSX Environmental Assessment, DOE/EA-1437 (September 2002)

NCSX General Requirements Document Rev-5 (GRD), NCSX-ASPEC-GRD-05, (July 2007)

<http://ncsx.pppl.gov/SystemsEngineering/Requirements/Specs/GRD/Rev5/NCSX-ASPEC-GRD-05-Signed.pdf>

NCSX Project Contingency Analysis, C.O. Gruber, (March 2008)

http://ncsx.pppl.gov/Reviews/FY08/BCP_2008/Docs/Contingency.pdf

NCSX Project Control System Description Rev 1 (August 2006)

NCSX Project Execution Plan, NCSX-PLAN-PEP-03 (June 2005)

http://ncsx.pppl.gov/SystemsEngineering/Plans_Procedures/NCSX_Mgmt_Plans/PEP/NCSX-PLAN-PEP-03-Signed.pdf

NCSX Project Quality Assurance Plan, NCSX-PLAN-QAP-01

http://ncsx.pppl.gov/SystemsEngineering/Plans_Procedures/NCSX_Mgmt_Plans/QAP/NCSX-PLAN-QAP-01-Signed.pdf

NCSX Project Training Matrices, NCSX-PLAN-TRNG Rev 3 (May 2008)

http://ncsx.pppl.gov/SystemsEngineering/Training/Training_Matrices/Project_Trng_Matrix/NCSX%20Project%20Training%20MatricesR3-Signed.pdf

NCSX Reliability, Availability, and Maintainability Plan, NCSX-PLAN-RAM-00

(February 2004)

http://ncsx.pppl.gov/SystemsEngineering/Plans_Procedures/NCSX_Mgmt_Plans/RAM/NCSX_PLAN_RAM_00.pdf

NCSX Risk Management Plan Rev-1, NCSX-PLAN-RMP-01 (May 2008),

http://ncsx.pppl.gov/SystemsEngineering/Plans_Procedures/NCSX_Mgmt_Plans/RMP/NCSX_PLAN_RMP-01-Signed.pdf

NCSX Safe Startup & Control Plan, NCSX-PLAN-SSU-00 (June 2006),

http://ncsx.pppl.gov/SystemsEngineering/Plans_Procedures/NCSX_Mgmt_Plans/SSU/NCSX-PLAN-SSU-00-Signed.pdf

NCSX Systems Engineering Management Plan, NCSX-PLAN-SEMP-00 (January 2005)

http://ncsx.pppl.gov/SystemsEngineering/Plans_Procedures/NCSX_Mgmt_Plans/SEMP/NCSX-PLAN-SEMP-00-Signed.pdf

NCSX Training Plan Rev-2, NCSX-PLAN-TRNG-02 (March 2006)

http://ncsx.pppl.gov/SystemsEngineering/Plans_Procedures/NCSX_Mgmt_Plans/TRNG/NCSX-PLAN-TRNG-02-Signed.pdf

NCSX Work Planning & Authorization Procedure, NCSX-PROC-004 Revision 2 (April 2005)

http://ncsx.pppl.gov/SystemsEngineering/Plans_Procedures/Procedures/PROC-004_WorkPlanning/NCSX-PROC-004-02-Signed.pdf

PPPL Design Verification, Procedure ENG-033 Rev 2 (May 2003)

<http://www.pppl.gov/eshis/procedures/eng033.pdf>

PPPL ES&H Directives, ES&HD 5008 (April 1999)

http://www.pppl.gov/eshis/ESHD_MANUAL/sm.html

PPPL Lab-wide Procedures Manual, <http://www.pppl.gov/eshis/procedures.html>

PPPL Lab-wide Policies Manual, <http://www.pppl.gov/eshis/policy.html>

Program & Project Management for the Acquisition of Capital Assets, DOE Order 413.3A

(July 2006) <http://www.er.doe.gov/opa/PDF/o4133a.pdf>

APPENDICES:

A. NCSX MIE PROJECT CHRONOLOGY

- 5/98 U.S. Stellarator Proof-of-Principle Program Plan Issued.
- 6/98 Compact Stellarator Program Approved Following DOE Peer Review; Pre-Conceptual Design of a Proof-of-Principle Experiment Initiated.
- 3/01 Report From FESAC Proof of Principle Sub-Panel Recommends Further Optimization Studies.
- 3/01 Physics Validation Review of Physics Requirements & Pre-Conceptual Design Successful.
- 5/01 Mission Need (CD-0) Approved by DOE.
- 6/01 FESAC Letter Endorsing Stellarator Proof-of-Principle Experiment Issued.
- 5/02 DOE-SC Review of Conceptual Design Report Finds Project Ready for CD-1 After Some Revision.
- 11/02 Preliminary Baseline Range (CD-1) Approved by DOE.
- 4/03 NCSX MIE Project Begins
- 11/03 SC Review of Preliminary Design Report Finds Project Ready for CD-2 After Appropriate Consideration to Committee's Comments & Recommendations. Also, External Independent Review (EIR) by the DOE Office of Engineering & Construction Management (OECM) Endorses Proposed Baseline.
- 2/04 Performance Baseline (CD-2) Approved by DOE.
- 6/04 SC Review of Readiness to Start Construction Finds Project Ready for CD-3 Pending Successful Outcome of VVSA and MCWF Procurement Process.
- 8/04 OFES Notifies PPPL Acknowledging ~ \$5M Increase in MCWF & VVSA Fabrication Costs Proposals with Warning of Possible Project Cancellation.
- 9/04 SC Mini-Review of Project Plan to Absorb the MCWF & VVSA Cost Increase; 22% Contingency Found Low; 5-mo Fabrication Delay Recognized.

- 9/04 Start of Construction (CD-3) Approved by DOE.
- 12/04 DOE_SC Mini-Review; Continued Concern Expressed About Technical Complexities & Adequacy of Cost & Schedule Contingencies.
- 1/05 OFES Alters Funding Profile; Directed Project to Prepare Baseline Change Proposal.
- 4/05 SC Mini-Review of BCP; Only Changes Attributed to Funding Stretch-out Allowed.
- 7/05 Baseline Change Approved by DOE Deputy Secretary.
- 11/05 SC Review Notes Satisfactory Cost & Schedule, but that Critical Work Remains in Early Stages (e.g., Winding Learning Curves); Predict Next 6 mo Would or Would Not Validate Project Cost & Schedule Assumptions.
- 1/06 MCWF Delivery Delays Cast Doubts on Vendor's Ability to Successfully Perform - Contract Re-Negotiated, & Acceptable Delivery Schedule Established.
- 1/06 Project Placed on SC Deputy Director's Watch List
- 5/06 SC Review Notes a Well-Functioning & Appropriately Staffed Project Team; Procurement Risks (e.g., MCWF) Found to be Substantially Reduced While Significant Risks Remained With In-House Assembly.
- 6/06 PSO Sends PPPL Director Letter Expressing Concerns About Rate of Contingency Drawdown and Requests "Unconstrained Bottoms-Up ETC.
- 7/06 PPPL Replies to PSO Stating Project Will Have to Manage Within Established Baseline.
- 11/06 PSO & OFES Meet with SC Director, Resulting in Revised Charge for 12/06 SC Review Asking How Much Additional Contingency Would Be Needed to Successfully Complete Project with "high confidence."
- 12/06 SC Review of Top-Down ETC that With \$12.4M Added to Contingency; Probability for Successfully Completing Project Within 2005 Baseline Found to Be Low; Committee Rejects ETC & Calls for Bottom-Up Estimate to Substantiate Proposed Cost & Schedule Contingency.

- 2/07 Project Informs PPPL Director that Cost will Significantly Exceed 12/06 Estimate. PPPL Director informs PU.
- 5/07 PU Establishes EIR. Committee Finds Need for Realistic Cost Estimates, Formal Risk Management, Continued Senior Management Attention.
- 6/07 PU EIR Recognize Improvements and Work in Progress.
- 6/07 New Interim Project Manager Appointed by PPPL.
- 8/07 SC Review of New Bottoms- Up ETC, with \$132M TEC & Dec 2011 CD-4 Date, Judged to be Achievable.
- 9/07 FESAC Science Review of Compact Stellarator Program and NCSX Results in Re-Affirmation of Science Case for NCSX, Even With Delayed Start-Up.
- 10/07 PU Review of Construction Feasibility Concludes that Team Can Succeed in Building & Maintaining NCSX.
- 1/08 OFES Directs Project to Prepare "Final" Bottoms-Up ETC and Prepare for SC Review and OECM EIR.
- 2/08 New Project Manager Appointed by PPPL
- 3/08 PU Review Finds Final Bottoms-Up ETC Estimates with Contingency to be Credible.
- 4/08 SC Review Judges Final Bottoms-Up ETC to be Non-Credible Due to Inadequate Design Maturity, Integration Complexity, Evolving Experience Base, Excluded Risk Events, and an Immature Risk Analysis And Contingency Calculation.
- 5/08 Project Submits Recovery Plan Addressing 4/08 SC EIR Recommendations.
- 5/08 SC Director Informs PU of Decision to Cancel NCSX Project.
- 6/08 Project Closeout Proposal Submitted to DOE.
- 7/08 OFES Concurs With Project Closeout Proposal.
- 10/08 Closeout Engineering Change Proposal (ECP-60) Approved by FES Director.
- 7/09 Project Closeout Complete.

B. 2005 BASELINE PROJECT PERFORMANCE OBJECTIVES

Parameter	Completion Objective at CD-4
First Plasma	<p>An Ohmically heated stellarator discharge will be produced with:</p> <ul style="list-style-type: none"> major radius 1.4 m. magnetic field of = 0.5 T plasma current of =25kA at least 50% of the rotational transform provided by stellarator fields. <p>The three-dimensional stellarator geometry will be confirmed by taking video images of the plasma.</p>
Coils and Power Supply Performance.	<p>The coils will be operated at cryogenic temperature and energized with the baseline power supplies (except as noted) to the following currents:</p> <ul style="list-style-type: none"> Modular coils: 12 kA TF Coils: 2 kA Central Solenoid Coils: 12 kA PF4 Coils: 3 kA PF5-6 Coils: 2 kA Trim Coils: 1 kA. (w/ temp. power supplies).
Magnet System Rating	<p>It will be demonstrated on the basis of component design verification data that the stellarator magnet system of modular coils, TF coils, and PF Ring coils are rated for operation at cryogenic temperatures to support plasma conditions with:</p> <ul style="list-style-type: none"> high beta (4%) magnetic field up to 1.6 T (0.2 s) or 1.2 T (1 s) Ohmic current drive up to 250 kA flexibility per the General Requirements Document
Magnet System Accuracy	<p>It will be demonstrated on the basis of design verification data, including electron-beam flux-surface mapping with the coils at room temperature, that the stellarator magnet system of modular coils, TF coils, and PF coils produces vacuum magnetic surfaces.</p>
Vacuum Vessel System Rating	<p>It will be demonstrated on the basis of component design verification data that the vacuum vessel system is rated for high-vacuum performance with:</p> <ul style="list-style-type: none"> base pressure less than or equal to 8×10^{-8} torr @293K global leak rate less than or equal to 5×10^{-5} torr-l/s @293K bakeable at 150 C.
Vacuum Pressure	A base pressure of 4×10^{-7} torr will be achieved.
Vacuum Pumping	A pumping speed of 1,300 l/s at the torus will be achieved.

Parameter	Completion Objective at CD-4
Controls	<p>Integrated subsystem tests, to the level required for First Plasma, will be completed for the following systems:</p> <ul style="list-style-type: none">• Safety interlocks.• Timing and synchronization.• Power supply real time control.• Data acquisition.
Neutral beams	<p>For one neutral beam injector:</p> <ul style="list-style-type: none">• Beamline operating vacuum shall have been achieved.• Beamline cryopanels shall be leak-checked.• A source shall be leak-checked

C. FINAL COSTS

(WBS 1)

WBS	JOB	FY2003	FY2004	FY2005	FY2006	FY2007	FY2008	FY2009	Total Cost thru JUNE 2009
12	*NUL Management Reserve	0	12	0	0	0	0	352	364
1201	Vacuum Vessel Design	424,475	0	0	0	0	0	0	424,475
1202	Vacuum Vessel R&D	758,588	1,012,747	0	0	0	0	(6,165)	1,765,170
1203	Vacuum Vessel Final Design	0	625,448	462,895	351,092	0	0	0	1,439,435
1204	VV Sys Procurements (non VVSA)	0	0	459	232,664	495,867	188,758	668	918,417
1206	VV Field Weld Joint R&D	0	0	15,955	0	0	0	0	15,955
1250	Vacuum Vessel Fabrication	0	0	2,890,538	2,695,492	(271,775)	0	0	5,314,255
1260	NB transition ducts	0	0	0	0	0	1,620	0	1,620
13	1301 TF Design	91,662	336,472	513,906	28,249	0	0	0	970,289
1302	PF Coil Design	0	0	0	19,339	45,395	62,410	0	127,144
1303	NCSX Central Solenoid Support System	0	0	0	132,865	20,487	0	0	153,352
1350	TF Coil Fabrication Preparation	0	0	394,072	141,807	0	0	0	535,880
1351	TF Coil Materials	0	0	179,102	272,916	30,057	0	0	482,075
1352	PF Coil Fabrication	0	0	0	0	0	169,590	0	169,590
1354	Trim Coil and I&C	0	0	0	0	0	218,539	1,437	219,976
1355	Coil local I&C	0	0	0	0	0	1,169	0	1,169
1361	TF Coil Fabrication	0	0	0	612,818	730,187	765,150	9,715	2,117,870
14	1401 MOD Coil Design	303,043	1,323	0	0	0	0	0	304,366
1402	MOD Coil Analyses	239,136	257,593	74,755	339	0	0	0	571,822
1403	WBS 14 Final Design	0	1,595,544	1,311,728	803,583	0	0	0	3,710,855
1404	MCWF R&D and Prod Casting	564,276	1,542,987	436,717	(966)	(23,822)	0	0	2,519,191
1405	MOD Coil Winding R&D Pre	168,064	0	0	0	0	0	0	168,064
1406	MOD Coil Winding R&D	831,115	1,292,333	123,613	15,582	607	0	0	2,263,251
1407	MOD Coil Winding Facility	267,545	2,278,305	98,215	23,921	0	0	0	2,667,986
1408	MOD Coil Winding Supplies	29,789	25,826	523,292	1,177,200	690,621	216,030	(2,250)	2,660,508
1409	MOD Coil Test Stand	0	343,290	572,423	(83,143)	0	0	0	832,570
1410	MC Twisted Racetrack	0	6,152	1,044,109	(704)	0	0	0	1,049,557
1411	Modular Coil Casting Fab	0	0	4,008,949	3,939,236	1,780,267	20,935	0	9,749,387
1412	Complete Winding Facilities	0	0	439,391	3,128	5,382	2,017	0	449,918
1413	NCSX MCWF Fracture Analysis	0	0	27,819	0	0	0	0	27,819
1414	Coil Testing	0	0	134,098	504,576	0	0	0	638,674
1415	Dimensional Control Testing	0	0	24,039	0	0	0	0	24,039
1416	Mod Coil Final Design Type A&B Coil	0	0	0	35,268	346,225	208,877	694	591,065
1419	NCSX Winding Facility Mode	0	0	48,434	0	0	0	0	48,434
1421	Mod Coil Interface Design & Procurement	0	0	0	32,796	871,977	814,473	(3,690)	1,715,556
1429	Mod Coil Interface R&D	0	0	0	0	241,000	24,366	0	265,366
1431	Mod Coil Interface Hardware Procurements	0	0	0	0	287,675	412,886	0	700,561
1451	Mod Coil Winding	0	0	137,831	2,981,996	3,491,407	1,593,002	0	8,204,237
1459	MCWF Unplanned Re-Work	0	0	0	276,246	478,140	326,097	12,667	1,093,150
1460	Mod Coil 3rd Winding Station	0	0	0	0	55,266	0	0	55,266
15	1501 Structures Design	0	20,086	54,556	38,678	394,463	285,760	0	793,543
1550	Structures Procurement	0	0	0	4,061	0	16,301	0	20,362
16	1601 Coil Services Design	0	0	0	2,615	0	136,591	0	139,206
17	1701 Cryostat Design	12,180	97,523	262,052	45,520	18,750	80,975	0	517,000
1702	Base Support Struct Design	0	0	0	0	0	198,059	0	198,059
1751	Cryostat fab								
1752	Base Support fab								
18	1801 Field Period Assembly (ORNL)	60,793	256	0	3,274	0	0	0	64,323
1802	FP Assy Oversight&Support	0	148,956	219,130	307,312	602,499	696,040	6,375	1,980,312
1803	FP Assy Tooling/Constructability	0	8,074	455,854	491,416	355,436	499,946	48	1,810,775
1804	FP Assy Measurement	0	181,247	256,657	110,338	10,578	0	0	558,820
1805	FP Assy Hardware & Fixtures	0	0	0	0	59,701	92,082	0	151,783
1806	FPA Specs and dwgs	0	0	0	0	28,524	71,231	1,439	101,194
1808	TF/Mod Coil Sub-Assembly	0	0	0	2,503	1,517	4,346	0	8,366
1810	Field Period Assembly	0	0	5,209	140,914	1,157,496	2,549,165	10,573	3,863,357
1815	Field Period Assy Station 5	0	0	0	0	3	0	0	3
1859	FP Assy Prototyping & Unplanned Work	0	0	0	0	34,869	0	0	34,869
19	1901 Stellarator Core Mgmt/Integration	254,165	707,094	524,031	466,110	286,904	362,270	15,405	2,615,979

National Compact Stellarator Experiment Project Closeout Report

(WBS 2-8)

WBS	JOB	FY2003	FY2004	FY2005	FY2006	FY2007	FY2008	FY2009	Total Cost thru JUNE 2009
2	NCSX Plasma Heat, Fuel & Vac System	0	0	0	0	0	0	0	0
2001	VPS Gas & Conditioning	57,501	2,579	0	0	0	0	0	60,080
2501	Neutral Beam Refurbishment	146,305	137,872	0	765	0	0	0	284,941
3	NCSX Diagnostics	0	0	0	0	0	0	0	0
3101	Magnetic Diagnostics	0	0	131,432	338,122	262,614	153,721	0	885,889
3601									
3801									
3901	Diagnostics Syst Integration	155,452	74,611	44,350	43,267	44,392	55,375	0	417,447
4	NCSX Electrical Power Syst	0	0	0	0	0	0	0	0
4101	AC Power	0	80,588	26,761	0	(104,103)	0	0	3,247
4301	DC Systems	2,393	409,394	(224,124)	143,319	0	29,087	0	360,069
4350	NCSX Hybrid Power Syst Concept Design	0	26,919	11,862	0	0	0	0	38,780
4401	Control & Protection	0	21,960	32,639	25,924	0	11,259	0	91,782
4501	Power Sys Dsn & Integr	112,344	25,955	0	13,252	8,809	0	0	160,361
4601	FCPC Bldg Modifications	1,305	0	0	0	0	0	0	1,305
5	NCSX Central I&C Syst	0	0	0	0	0	0	0	0
5101									
5201									
5301									
5401									
5501									
5601									
5801	Central I&C Integration	11,949	19,156	1,923	0	0	16,868	0	49,895
6	NCSX Facility Syst	0	0	0	0	0	0	0	0
6101									
6163	Facility Systems Support	0	14,873	0	0	0	0	0	14,873
6201	Cryogenic Systems	0	0	0	0	0	41,594	0	41,594
6301									
6401									
6501	Facility Systems Integration	9,377	0	0	0	0	0	0	9,377
7	NCSX Test Cell Prep & Machine Assy	0	0	0	0	0	0	0	0
7101	Shield Wall MOD Des	32,150	0	0	455	0	0	0	32,605
7301	Platform Design/Fab	0	0	72,997	2,941	0	0	0	75,938
7401	TC Prep & Mach Assy Planning	131,681	197,552	465,710	43,718	(266,744)	82,138	0	654,055
7501	Construction Crew	0	0	29	0	0	0	0	29
7503	Machine Assy								
7601									
8	NCSX Project Oversight & Suprt	0	0	0	0	0	0	0	0
8101	Project Management PPPL	223,477	877,505	690,499	601,951	559,352	949,031	99,654	4,001,469
8102	Project Management ORNL	58,590	92,821	103,909	174,539	233,271	188,093	4,558	855,781
8202	Engr Mgmt & Sys Eng Support	295,529	695,079	624,512	665,422	683,516	574,669	19,110	3,557,837
8203	Design Integration	178,751	382,155	125,604	166,370	169,918	189,757	0	1,212,554
8204	System Analysis	44,614	176,722	278,162	470,717	532,690	492,611	0	1,995,515
8205	NCSX Dimensional Control	0	0	89,668	149,013	153,182	104,989	48	496,900
8210	Project Rebaseline Estimating	0	0	0	0	82,104	28,071	0	110,175
8215	Plant Design	0	0	0	0	0	5,960	0	5,960
8220	NCSX Equip Disposition & Facility Restora	0	0	0	0	0	280,984	328,839	609,823
8221	NCSX Documentation for closeout	0	0	0	0	0	394,809	181,312	576,121
8401	Project Physics PPPL	374,124	113,028	356	0	0	0	0	487,508
8402	Project Physics ORNL	40,984	105,484	0	0	0	0	0	146,468
8501	NCSX Integrated Sys test Doc	0	0	0	0	0	3,929	0	3,929
8998	Allocations	60,666	303,828	415,492	424,003	409,245	515,156	59,260	2,187,651
DCMA			75,000						75,000
		5,942,023	14,314,349	18,131,612	19,072,816	14,993,950	14,136,786	740,049	87,331,586

Total TPC

Total Project Cost Summary
(through July 2009)

	Cost To Date	ETC	EAC	BA	Un-spent
TEC (MIE funds) =	\$87,317,751	\$2,000	\$87,319,751	\$87,430,811	\$111,060
OPC					
Conceptual Design (FY08,09)	\$9,570,000	-	\$9,570,000	\$9,570,000	-
Manuscripts Preparation	\$224,799	-	\$224,799	\$256,000	\$31,201
TOTAL TPC =	\$97,112,550	\$2,000	\$97,114,550	\$97,256,811	\$142,261

E. COST ESTIMATE HISTORY

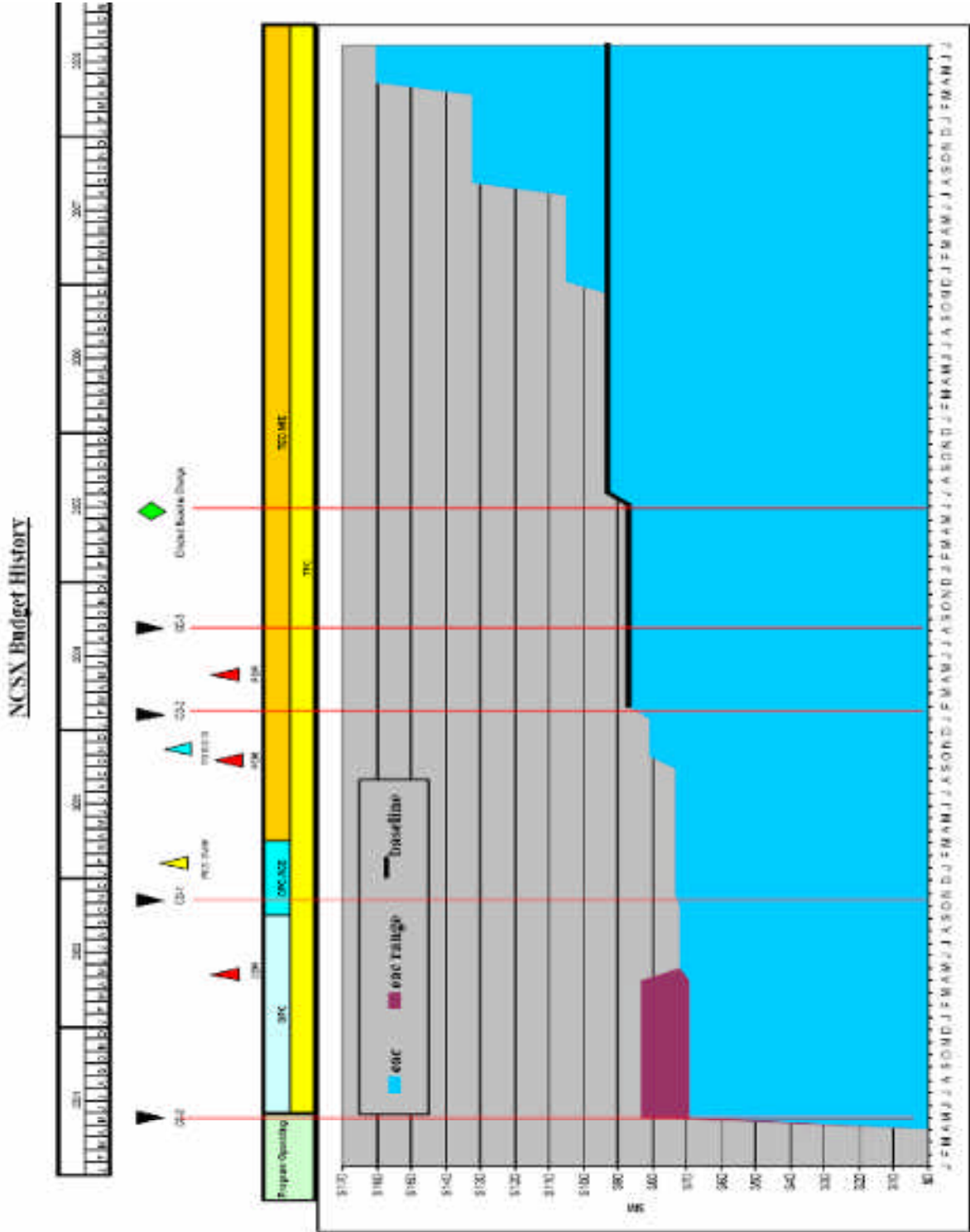

National Compact Stellarator Experiment Project Closeout Report

	CD-2 Baseline ECP-004	Directed Change ECP-031	August 2007 EAC	March 2008 EAC
	2/12/04	8/11/05	8/1/07	3/23/08
	CD-2 Baseline ECP-004	Directed Change ECP-031	August 2007 EAC	March 2008 EAC
	2/12/04	8/11/05	8/1/07	3/23/08
Component Fabrication	34,582	46,325	60,716	65,136
12 Vacuum Vessel	6,073	9,531	9,909	11,172
13 Conventional Coils	4,168	4,790	6,688	8,088
14 Modular Coils	20,548	28,092	40,443	40,731
15 Coil Structures	1,450	1,412	1,597	2,073
16 Coil Services	1,037	1,140	864	1,087
17 Cryostat & Base Structure	1,305	1,360	1,215	1,986
Assembly	9,364	9,842	22,498	29,247
18 Field Period Assembly	5,110	5,430	13,583	19,962
7 Test Cell Prep & Machine Assy.	4,254	4,412	8,914	9,285
Ancillary Systems	14,468	9,158	8,741	12,013
2 Fueling & Pumping	1,627	784	589	1,365
3 Diagnostics	1,681	1,143	1,671	1,941
4 Electrical Power Systems	5,318	3,301	3,145	3,333
5 Central I&C/Data Acq.	2,580	2,050	1,169	2,132
6 Facility Systems	2,038	691	1,403	2,447
85 Integrated System Testing	1,225	1,189	765	795
Engineering Mgt. & Integration	7,853	8,106	15,415	19,148
Management	4,151	6,161	10,662	12,634
Total Work	70,418	79,592	118,032	138,179
Contingency	15,910	12,804	14,380	22,410
Total	86,328	92,396	132,412	160,589

	CD-2 Baseline ECP-004	Directed Change ECP-031	August 2007 EAC	March 2008 EAC
	2/12/04	8/11/05	8/1/07	3/23/08
1 Stellarator Core	42,355	54,507	78,047	89,670
12 Vacuum vessel	6,073	9,531	9,909	11,172
<i>Design</i>	2,218	3,233	3,428	3,428
<i>Fabrication</i>	3,856	6,298	6,481	7,744
13 Conventional Coils	4,168	4,790	6,688	8,088
<i>TF Coils</i>	1,690	2,555	4,055	4,151
<i>PF & Trim Coils</i>	2,479	2,235	2,633	3,937
14 Modular Coils	20,548	28,092	40,443	40,731
<i>Design & R&D</i>	2,342	4,658	7,969	7,870
<i>Modular Coil Winding Forms</i>	7,853	10,886	12,432	12,448
<i>Modular Coil Fabrication</i>	9,923	12,060	18,571	18,941
<i>Modular Coil Testing</i>	430	488	1,472	1,472
15 Coil Structures	1,450	1,412	1,597	2,073
<i>Design</i>	310	221	517	629
<i>Fabrication</i>	1,140	1,191	1,080	1,443
16 Coil Services	1,037	1,140	864	1,087
<i>Design & Fabrication</i>	1,037	1,140	864	1,087
17 Cryostat & Base Structure	1,305	1,360	1,215	1,986
<i>Cryostat & Base Structure</i>	1,305	1,360	1,215	1,986
18 Field Period Assembly	5,110	5,430	13,583	19,962
<i>Design, Constructability, & Tooling</i>	1,427	1,281	2,276	2,884
<i>Assembly Operations</i>	3,684	4,149	11,307	17,078
19 Stellarator Core Mgt. & Int.	2,663	2,752	3,748	4,572
<i>Stellarator Core Mgt. & Int.</i>	2,663	2,752	3,748	4,572
2 Auxillary Systems	1,627	784	589	1,365
<i>Fueling</i>	140	151	132	401
<i>Torus Vacuum Pump</i>	384	349	172	679
<i>Neutral Beams</i>	1,103	284	285	285
3 Diagnostics	1,681	1,143	1,671	1,941
<i>Magnetic Diagnostics</i>	1,290	787	1,377	1,653
<i>Imaging & e-beam mapping</i>	391	356	294	288
4 Electrical Power Systems	5,318	3,301	3,145	3,333
<i>Electrical Power Systems</i>	5,318	3,301	3,145	3,333
5 Central I&C/Data Aq.	2,580	2,050	1,169	2,132
<i>Central I&C/Data Aq.</i>	2,580	2,050	1,169	2,132
6 Facility Systems	2,038	691	1,403	2,447
<i>Cryogenic Systems</i>	747	463	655	1,568
<i>Vacuum Vessel Bakeout System</i>	629	-	573	634
<i>Other</i>	661	228	175	246
7 Test Cell Prep & Machine Assy.	4,254	4,412	8,914	9,285
<i>Design, Area Prep. & Tooling</i>	492	482	724	720
<i>Assembly Operations</i>	3,762	3,930	8,190	8,565
8 Project Mgt. & Integration	10,566	12,704	23,019	27,930
81 Project management	3,195	4,584	7,718	8,843
82 Engineering Mgt. & Integration	4,689	4,884	11,197	14,105
<i>Eng. Mgt. / System Integ. Support</i>	288	2,835	5,295	6,437
<i>System Engineering</i>	4,401	2,049	5,901	7,668
84 Project Physics	501	470	470	470
85 Integrated System Testing	1,225	1,189	765	795
89 Allocations	956	1,577	2,869	3,716
Total Work	70,418	79,592	117,957	138,104
DCMA			75	75
Contingency	15,910	12,804	14,380	22,410
Total	86,333	92,401	132,412	160,589

F. BASELINE CHANGE CONTROL LOG

ECP Number	Title	Date Approved or Disapproved	Impacted WBS Elements	Type of Impact (Tech, Cost, or Schedule)
059	VV Pressure Test Reqmts	2/25/2008	18	Technical
058	Update of VV & Station 1 FPA Requirement Documents	11/5/2007	12 & 18	Technical
057	Update of TF Coil Assembly CSPEC	9/18/2007	131	Technical
056	Update of Plasma Spray Coating for Prototype and Production Modular Coil Shims	8/9/2007	142	Technical
055	Updated Requirements	8/3/2007	WBS 1, 4, & 7	Technical
054	FY2007 Rebasclining			
053	Near Term Replanning	2/9/2007	All	Technical, Cost, & Schedule
052	FY2007 Replanning, Risk Retirement, and Estimate Updates	11/1/2006	All	Cost & Schedule
051	Update of TF Coil Assembly CSPEC (NCSX-CSPEC-131-01)	12/07/2006	131	Editorial Update to Reflect Latest Drawing List
050	WBS 3 Internal Reprogramming	7/27/2006	3	Cost
049	Risk Retirement - FY2006 Scope Completions	7/31/2006	14, 17, & 4	Cost
048	Update of GRD (Rev 4)	7/14/2006	All	Technical & Editorial
047	Update of MCWF CSPEC (Rev 12)	7/18/2006	14	Technical
046	Update of TF Coil Assembly Requirements	4/13/2006	14	Technical
045	May 2006 PMB Update	6/13/2006	14	Technical, Cost &

				Schedule
044	Update of VVSA CSPEC		12	Technical
043	March 2006 PMB Updated	3/27/2006	14, 18	Cost & Schedule
042	MCWF Machining Improvements	2/9/2006	14	Technical (Cost and Schedule will be in ECP-043)
041	Update of PMB - December 2005	ECP Rescinded 3/6/2006	12, 18	Schedule
040	Updated of Modular Coil SRD	12/2/2005	14	Technical
039	PMB Update	11/9/2005	12, 13, 14, 17, 18, 3, 4, 7, 8	Cost & Schedule
038	MCWF Technical Requirements Update	11/3/2005	13	Technical
037	Revision 3 to the GRD	9/9/2005	13, 14, & 4	Technical
036	Risk Retirement, Budget Reallocation, Correction of Data Error, and New Work	8/9/2005	12, 14, & 19	Cost & Schedule
035	Changes to MCWF Technical Requirements	8/5/2005	14	Technical
034	Vacuum Vessel Trinos Flanges	7/11/2005	12	Cost
033-R1	Revision 1 to MCWF Technical Reqmts	7/19/2005	14	Technical & Cost
032	RFD-14-006 - permit 2.5" and 3.5" pipe to be manufactured from ASTM 625 plate	5/27/2005	12	Technical
031	DOE Directed Rebaseline	8/10/2005	All	Cost & Schedule
030	Planning Changes for Risk Management	5/4/2005	All	Technical, Cost, & Schedule
029	Retirement of Risks for VVSA Forming Dies and Twisted Racetrack Assembly	4/21/2005	12 & 14	Cost
028	RFD-14-001 - Relocation of	3/30/2005	14	Technical

	Pattern/Casting ID Number			
027	RFD-12-002R1 - Substitution of Sch10 Pipe for Sch40 Pipe for the 2.5" Pipe	3/24/2005	12	Technical
026	MCWF Fast Response	3/14/2005	141	Technical
025	RFD-12-001 - Manufacture of the 6", 8" and 10" Pipe from ASTM 625 Plate	3/10/2005	12	Technical
024	Miscellaneous Rescheduling and Contingency Draw for Added and Re-Estimated Scope	3/7/2005	12, 13, 81 & 82	Technical, Cost, & Schedule
023	MCWF Minimum Mechanical Properties	2/17/2005	141	Technical
022 R1	TRC Design Updates	R1 - 2/3/2005	142	Technical, Cost, & Schedule
021	Job Close-Out & Contingency Drawdown	1/31/2005	12, 141, 142, & 84	Cost & Schedule
020	Resolution of MCWF Questions (Dec-2004)	1/14/2005	141	Technical
019	VVSA Contract Addenda 3-1 though 3-3	1/25/2005	121	Technical
018	FY005 Replanning Baseline	11/19/2004	12, 14, 15, 18, 19, 3, 4, 5, & 7	Technical, Cost, & Schedule
017R1	VVSA Inner Support Bosses	11/9/2004	121	Technical
016R1	Reprogramming for FY2004 Closeout	11/9/2004	121, 133, 141, 142, 144, 19, 21, 432, 612, 614, & 82	Technical, Cost, & Schedule
015	Final Technical Scope of MCWF	9/17/2004	141	Technical
014	CD-3 Replanning	9/20/2004	12, 14, 187, 25, 3, 4, 5, 62, 64, 81, 82, 84, & 85	Technical, Cost, & Schedule
013	Modifications to VV Joint R&D Seals and End Pieces	7/30/2004	121	Technical & Cost

012	MCWF Lead Block and Support Modifications	7/30/2004	141	Technical
011	Rebaseline for Modular Coil WAFs	7/28//2004	14	Cost & Schedule
010	Prototype Winding Form Poloidal Break Geometry	6/28//2004	141	Technical
009	Reprogramming	7/8/2004	141, 142, & 185	Technical, Cost, & Schedule
008	Update of the Technical Baseine to Reflect the VVSA and MCWF FDR Design Configuration	6/23/2004	121, 141, & 185	Technical, Cost, & Schedule
007	Twisted Racetrack VPI Groove Depth	4/28/2004	141	Technical
006	Updated Cost and Schedule Estimate for Design and R&D	4/29/2004	121, 13, 141, 144, & 144	Technical, Cost, & Schedule
005	Revised Estimates fro Design, R&D, and Tooling	3/15/2004	12, 14, 18, 2, 3, 4, 5, 6, 7, & 8	Technical, Cost, & Schedule
004	CD-2 Cost and Schedule Baseline	2/28//2004	12, 14, 16, 18, 2, 3, 4, 5, 6, 7, & 8	Technical, Cost, & Schedule
003	FY2004 Management Reserve Distributions	1/20/2004	Various WBS Elements	Cost
002	Change in MCWF Design	11/18/2003	141	Technical
001	Revision 1 to the General Requirements Document	1/23/2004	1, 2, 3, 4, 5, 6, & 7	Technical

G. RISK MANAGEMENT

The NCSX Risk Management Plan (NCSX-PLAN-RMP-01) was substantially revised in 2008, considering factors within the Project’s control that both threatened and provided opportunities to improve project cost and schedule performance and the achievement of project technical objectives. Risk analysis involved a systematic evaluation of identified risk events by determining the probability of occurrence and consequences, assigning a risk rating based on established criteria, and prioritizing the risks. The first step in the risk analysis process was to determine for each risk event the probability that the risk item will actually occur. Table 19 provides guidelines for classifying risks in terms of likelihood that they will occur.

Table 19: Risk Classification

Risk Likelihood of Occurrence	
Classification	Probability of Occurrence
Very Likely (VL)	$P \geq 80\%$
Likely (L)	$80\% < P \geq 40\%$
Unlikely (U)	$40\% < P \geq 10\%$
Very Unlikely (VU)	$10\% < P \geq 1\%$
Not Credible (NC)	$P < 1\%$

The next step was to determine for each risk item the magnitude of the consequences should the event occur. For NCSX, consequences were assessed in terms of cost and schedule impacts, and classified in accordance with Table 20.

Table 20: Risk Consequences

Impacts	Classification				
	Negligible	Marginal	Significant	Critical	Crisis
Technical	No impact of performance	Minor degradation of performance	Moderate degradation of performance	Moderate degradation of performance	Desired performance in doubt
Cost	< \$100K	\geq \$100K	\geq \$500K	\geq \$1M	\geq \$5M
Schedule	<0.5 Months	\geq 0.5 Months	\geq 1 Months	\geq 3 Months	\geq 6 Months and will impact CD-4

Once the risk likelihood and consequences were established, a risk ranking was assigned to each risk item. This rating was a qualitative measure of the severity of the risk item and provides a starting point for development of risk management priorities. The risk ranking was assessed based on likelihood and consequences, and classified as high, medium, or low in accordance with Table 21.

Table 21: Risk-Ranking Matrix

		Impact				
		Negligible	Marginal	Significant	Critical	Crisis
Likelihood	VL	Low	Moderate	High	High	High
	L	Low	Moderate	Moderate	High	High
	U	Low	Low	Moderate	Moderate	High
	VU	Low	Low	Low	Moderate	High
	NC	Low	Low	Low	Low	Low

There were four approaches to handling risk: avoidance, transfer, mitigation, and acceptance. Risk avoidance represented change in the concept, requirements, specifications, and/or practices that reduce risk to an acceptable level. Risk transfer represented an allocation of risk to other activities outside the NCSX MIE project, thereby reducing the overall project risk. Risk mitigation represented the implementation of activities to reduce the consequences (likelihood and/or impact) of a risk event. The goal of mitigation was to retire risks so that their consequences did not affect the project or to minimize those consequences to the project. Mitigation activities were typically budgeted and scheduled in the project baseline unless those activities were on hold pending further project development or the occurrence of certain risk triggers. Risk acceptance was an acknowledgment of the existence of a particular risk situation and a conscious decision to accept the impact on the project’s baseline. Acceptance could entail a decision not to mitigate a risk, or a decision to accept a residual risk after mitigation activities were completed. The impacts of an accepted risk were to be budgeted and scheduled in the project baseline.

Priority was placed on identifying and mitigating risks. The NCSX risk registry was the vehicle for documenting identified risks, risk mitigation activities, affected jobs, ownership responsibilities, retirement deadlines, likelihood, consequences, estimated impacts and their bases, and the risk level classification. In 2008, the risk registry key input grew from 36 to 88 items that were statused and updated monthly. A snapshot of one page from the NCSX risk registry is illustrated in Figure 24.

Each Job Manager was responsible for developing a detailed and thorough estimate of the resources in their WAFs. Both cost estimates and schedule durations had inherent levels of uncertainty that was a result of the degree of design maturity and complexity of the elements involved – in effect, how much definition exists to provide a basis for the estimate. As means to measure this uncertainty, the NCSX Project developed standard definitions for both design maturity complexity categorizations as shown in Tables 22 and Table 23.

NCSX Risk Register

										Likelihood NL: 10% L: 50%-75% AL: 80%-95% NL: 95% NL: 10%	Consequences Minimal: 0-10% Moderate: 10%-25% Significant: 25%-50% Critical: 50%-100% Catastrophic: >100%		
No.	Affected Job (name)	Risk Description	Mitigation Plan (if job above budget)	Deadline to Avoid Risk or Avoid Impact	Owner	Current Status (As of March 8, 2008)	Likelihood of Occurrence	Consequences	Risk Rating	Rate of Change	Cost Impact (\$)	Schedule Impact (week)	
TECHNICAL RISK - General Assembly Risk													
Aspy-1	707	Module 7 coil and reference gears when Assembly Sequence Plan Sub-structure	Finalize Tooling Design and Assembly Sequence Plan (Sub: 707-820)	Final Module 7 Tooling CDD is complete	Owner	Future Risk	AL	High	Medium	10% increase in time required for sub-F-7	\$20	+1T	
Aspy-2	708	Module 6 coil and reference gears when Assembly Sequence Plan Sub-structure	Finalize Component Design and Assembly Sequence Plan (Sub: 708-100, 101, 101-820)	Final version FDDs	Owner	Future Risk	AL	High	High	20% increase in time required for sub-F-6	\$12	+1T	
Aspy-3	709	Module 6 coil and reference gears when Assembly Sequence Plan Sub-structure	Finalize Component Design, Part Layout, and Assembly Sequence Plan (Sub: 709-100, 100-100, 820)	Finalize FDD	Owner	Future Risk	AL	High	High	15% increase in time required	\$40	+2T	
Aspy-4	710-711-750	Photogrammetry stations used to locate torus positions and wire time and money (Opportunity)	Report completion, identify equipment, assess potential for 710 in cycle A support being added (710-711)	Sept. 2008	Station / Chuck	Future Risk	L	High	Medium	10% reduction in knowledge needed	\$60	(1T)	
Aspy-5	712-713-740	Assembly delivered due to missing required components of assembly	Identify high cost items via manufacturer contracts, update and release sub-F-7 (712-713)	Completion of FDD, status 4	Frank / Chuck	Phase required, non-terminable sub-terminated start	L	High	Medium	2 components @ \$15 each	\$1	+1D	
Aspy-6	702-703-750	Drawings prepared during design of equipment in a contract not available to support the schedule	Finalize all equipment in FDD (Sub: 702, 703, 750)	After release of FDD	Subra	Sub required additional in 702 & 703 sub	L	High	Low	Up to 2 week impact on FDD and cost of sub	\$1	+0.5T	

Figure 35: Snapshot page from the NCSX MIE Risk Registry

Table 22: Design maturity definitions

Design Maturity	Definition
High	Final design available. All design features/requirements are well known. No further significant design development or evolution is expected that will impact the estimate => relatively low probability of change..
Medium	Preliminary design is available. Some additional design evolution is likely. Further developments can be anticipate and will impact the estimate => relatively moderate probability of change..
Low	At the conceptual design level. Design details still need much development and evolution of requirements beyond the current estimate basis is anticipated and very likely => relatively high probability of change.

Table 23: Design complexity definitions

Design Maturity	Definition
Low	Work is fairly well understood – either standard construction or repetition of activities performed in the past. Little likelihood of estimate not being well understood and requirements not being well defined
Medium	More complex work requirements that have potential to impact cost and schedule estimates. Relatively limited experience performing similar tasks, so ability to estimate accurately is somewhat limited.
High	Extremely challenging tasks and/or requirements. Unique or first-of-a-kind assembly or work tasks. Very limited basis for estimating this work exists, so there is a high degree of uncertainty.

Table 24 translates the combination of design maturity and design complexity into uncertainty ranges that were used in NCSX contingency analysis. These ranges were based on standard industry and DOE estimate classifications (*e.g.*, ASCEI Recommended Practice 18R-97, *Cost Estimate Classification System*).

Table 24: NCSX Estimate Uncertainty Ranges

		Design Complexity		
		Low	Medium	High
Design Maturity	Low	- 15% to +25%	-20% to +40%	-30% to +60%
	Medium	-10% to +15%	-15% to +25%	-20% to +40%
	High	-5% to +10%	-10% to +15%	-15% to +25%

The NCSX Project employed a structured process to assess and analyze all areas of risk and uncertainty that might affect the cost and schedule estimates on the projects. Probabilistic risk assessment techniques with Monte Carlo analyses were used. Inputs to this analysis were the uncertainty ranges for each job and the likelihood and impacts for each risk. The result was an estimate of the cost and schedule contingency allowances required to cover the estimated uncertainties and risks in the project for a given level of confidence that the proposed baseline estimates would not exceed. Further details may be found in the report *NCSX Project Contingency*.

H. CONTINGENCY USE

Contingency Utilization History								
ECF No	Date	TEC (\$K)	Title	Oversuns & Estimate Increases (\$K)	Scope Adjustments & Value Engineering (\$K)	Contingency Draw Down (\$K)	Contingency Remaining (\$K)	Comments
4	Dec-2003	95,345					\$15,910	PMB Established
5	Mar-2004		Revised Estimates for Design, R&D, Tooling	+ \$860	-\$ (300)	-\$ (560)	\$15,350	Increase cost for VV, FFA, Mgt & Integr; Reduced cost for Mod Coil Fab & MCWF R&D
6	Apr-2004		Revised Est for Design & R&D	+ \$630		-\$ (630)	\$14,720	Increase cost for VV, Conv Coils, MCWF
8	Jun-2004		VVSA & MCWF PDR Configuration	+ \$542		-\$ (542)	\$14,178	
9	Jul-2004		Reprogramming	+ \$458	-\$ (458)	+ \$0	\$14,178	Increase budget for, Mod Coils; Decrease for: FFA
11	Jul-2004		Modular Cost Rebaseline	+ \$1,463		-\$ (1,463)	\$12,695	
14	Sep-2004		CD-3 Replanning	+ \$4,248	-\$ (5,008)	+ \$760	\$13,455	Offsets found for MCWF & VVSA cost increases and schedule delays
16	Nov-2004		Reprogramming	+ \$977	-\$ (977)	+ \$0	\$13,455	Scope Transfers: Trim coils, heating, electrical, NE cooling, bakeout, Reprogrammed to: VV, MCWF, MC Winding, mgt& integr
18	Nov-2004		FY05 Replanning	+ \$402		-\$ (402)	\$13,053	Increase budget for, VV, MC, Conv Coils, Mgt & Integr. Decr for: Steel Integr & mgt, power.
21	Jan-2005		Job Close Out	+ \$297		-\$ (297)	\$12,756	MC Winding, VVSA Int
24	Mar-2005		Misc Rescheduling & Contingency Draw	+ \$316		-\$ (316)	\$12,440	VVSA Fab, TF Core, dimensional control (new scope), Prog mgt
29	Apr-2005		VVSA Risk Rebasement	+ \$530		-\$ (530)	\$11,910	VVSA Forming Dies
30	Apr-2005		Planning Changes	+ \$259	-\$ (259)	+ \$0	\$11,610	Increase budget for: Stellarator Core; decrease: Cooling water commissioning; mgt& oversight
31	Jun-2005	92,491	FY05 DOE-Directed BCP	-\$ (1,194)		+ \$1,194	\$12,804	
33	Jul-2005		MCWF Requirements	+ \$38		-\$ (38)	\$12,766	
34	Jul-2005		VV Trinos Flange	+ \$40	-\$ (40)	+ \$0	\$12,766	cost increases offset: transfers
36	Aug-2005		Risk Retirement	+ \$797		-\$ (797)	\$11,969	
39	Oct-2005		Oct05 PMB Update	+ \$3,423	-\$ (1,099)	-\$ (3,357)	\$9,612	
43	Mar-2006		Mar06 PMB Update	+ \$862		-\$ (862)	\$8,720	
45	Jun-2006		May06 PMB Update	+ \$3,746	-\$ (3,197)	-\$ (549)	\$8,171	
45	Jul-2006		Risk Retirement	+ \$297		-\$ (297)	\$7,874	
50	Jul-2006		WBS-3 Reprogramming	+ \$56	-\$ (59)		\$7,874	
52	Oct-2006		2007 Replanning	+ \$1,577	-\$ (330)	-\$ (1,247)	\$6,627	
53	Jan-2007		Near Term Planning	+ \$2,177	-\$ (1,683)	-\$ (694)	\$6,033	Cost increases offset by cuts and transfers
			Subtotal	+ \$23,164	-\$ (13,277)	-\$ (9,877)		
			Total	+ \$28,210	-\$ (13,277)	-\$ (14,733)		

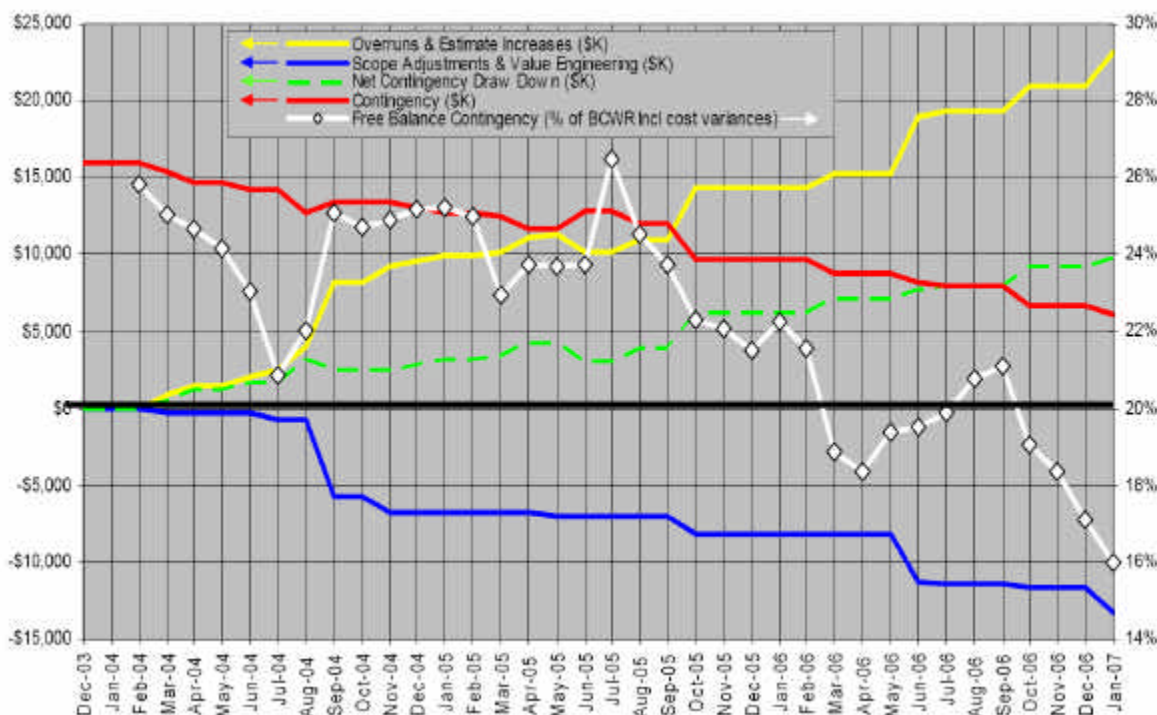

Figure 36: NCSX contingency use that was associated with project baseline changes. Details and authorization were documented through Engineering Change Proposals (Appendix F) in accordance with the NCSX Project Configuration Management Plan.

I. MAJOR PROCUREMENTS

NCSX Acquisition Contract Status (procurements over \$100k)						
WBS Number	Description	Vendor	Planning Estimate (at CD-2)	Contract Award	Actual Cost	Comments
1202 S043440X	Vacuum Vessel Prototype	Major Tool & Machine	\$400,340		\$655,000	Cost plus contract.
1202 S043450X	Vacuum Vessel Prototype	Rohwedder	\$350,900		\$518,911	Cost plus contract.
1250 S005243	Vacuum Vessel assemblies	Major Tool & Machine	\$2,729,000	\$4,535,560	\$5,013,454	Planning estimate range \$2.55M - \$2.91M
1351 PE005935	TF Conductor	Outkumpu	\$84,214		\$106,743	
1361 S006639	TF Coil Fabrication (excl conductor and insulation)	Everson Tesla	\$872,000	\$1,481,660	\$1,481,660	Forecast Actual Cost
1406 PE43710X	Twisted race track winding form	Energy Industries of Ohio	\$14,500		\$102,835	
1404 S043410X	Modular Coil Winding Form Prototype	Energy Industries of Ohio	\$623,040		\$1,445,794	Cost plus contract.
1404 S043400X	Modular Coil Winding Form Prototype	J.P. Pattern	\$561,190		\$492,644	Cost plus contract. Contract terminated prior to start of machining
1411 S005242	Modular Coil Winding forms (18 production articles)	Energy Industries of Ohio	\$4,839,000	\$8,013,502	\$9,218,637	Planning estimate range \$4.37M - \$5.31M
1408 PE005371	Modular coil conductor	New England Wire	\$260,000		\$230,141	
1431 PE007332	Supernuts	Superbolt	\$123,700		\$113,050	
1804 PE43530X	Romer Arm	Romer Cimcore	\$135,000		\$104,890	
1810 PE008029	Laser Tracker	Faro Technologies	\$55,000		\$104,186	
		TOTALS =	\$11,047,884		\$19,587,745	
1352 n/a	PF Coil Fabrication (excl conductor & insulation)	Everson Tesla	\$400,000	\$688,000		Contract award cancelled due to project termination

J. STAFFING

Need ORNL Sep 08 + FY09 forecast data

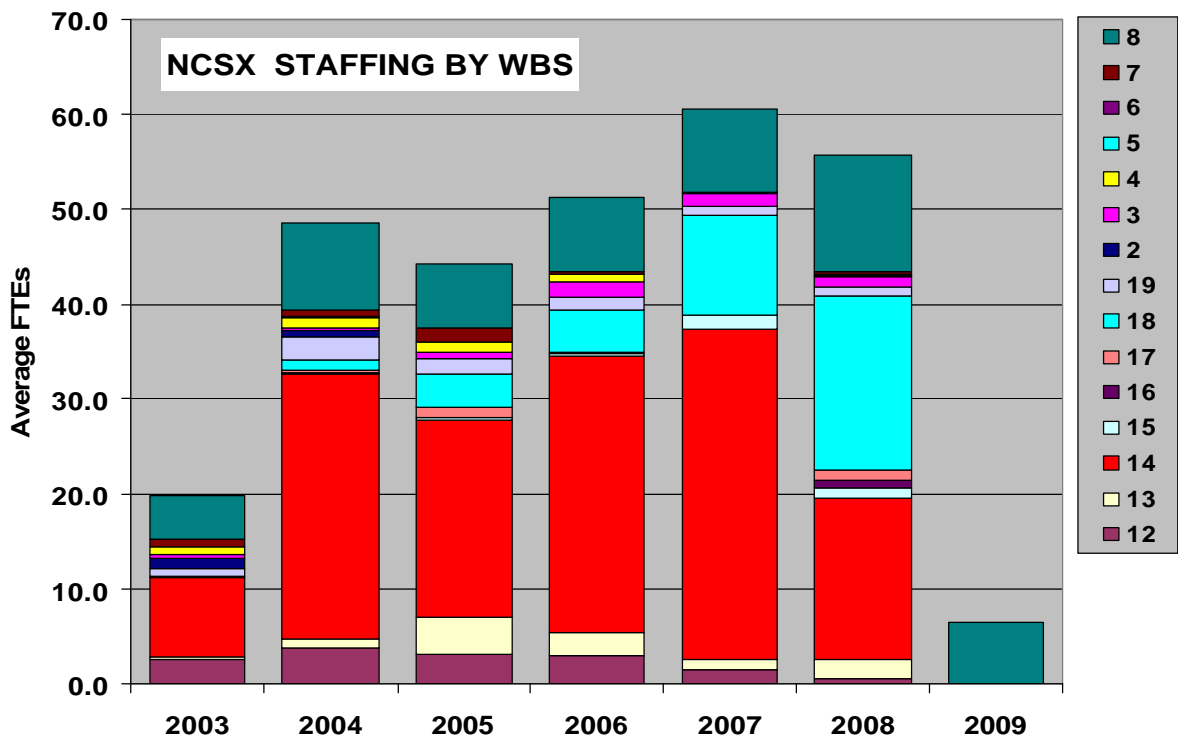
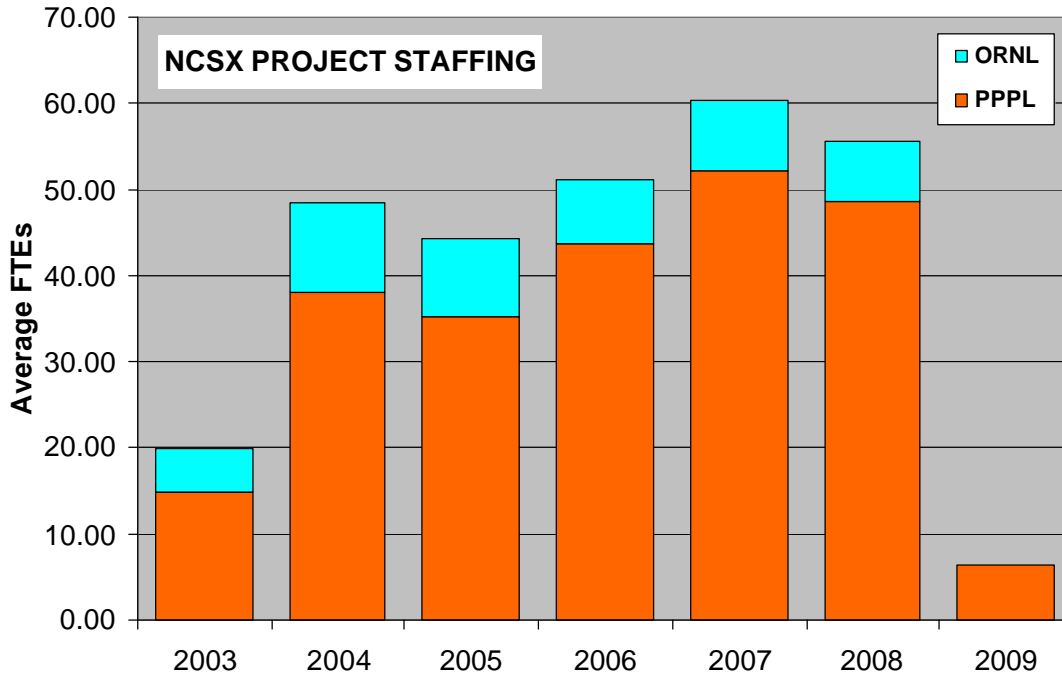

K. MAJOR EXTERNAL NCSX PROJECT REVIEWS

Review materials & reports archived at:

<http://ncsx.pppl.gov/Management/Mgmt.html>

No	Date	Sponsor	Review Topic/Report	Purpose
1	3/01	DOE-OFES	Physics Validation Review	Pre-CDR Validation
2	5/02	DOE-SC	Technical, Cost, Schedule, ES&H, and Management Review of NCSX	CDR Approval
3	2/03	DOE-PSO	Project Control Systems Review	Compliance Audit
4	10/03	PPPL Director	Preliminary Design Review	PDR Validation
5	11/03	DOE-SC	Technical, Cost, Schedule, ES&H, and Management Review of NCSX	CD-2 Readiness
6	11/03	DOE-OECM	External Independent Review of Acquisition Performance Baseline	CD-2 Readiness
7	2/04	ESAAB	Establishing Performance Baseline	CD-2 Approval
8	5/04	PPPL Director	Final Design Review	CD-3 Readiness
9	6/04	DOE-SC	Technical, Cost, Schedule, ES&H, and Management Review of NCSX	CD-3 Readiness
10	9/04	DOE-SC	Technical, Cost, Schedule, , and Management Mini-Review of NCSX	CD-3 Readiness
11	9/04	ESAAB	Starting Construction	CD-3 Approval
12	12/04	DOE-SC	Technical, Cost, Schedule, , and Management Mini-Review of NCSX	Status Review
13	4/05	DOE-SC	Mini-Review of Proposed BCP	BCP Concurrence
14	7/05	ESAAB	OFES directed baseline change due to funding profile changes	Approval ECP #031

15	11/05	DOE-SC	Technical, Cost, Schedule, ES&H, and Management Review of NCSX	Status Review
16	5/06	DOE-SC	Technical, Cost, Schedule, ES&H, and Management Review of NCSX	Status Review
17	9/06	DOE-SC	Technical, Cost, Schedule, , and Management Mini-Review of NCSX	Status Review
18	12/06	DOE-PSO	Cost, Schedule, and Management Review of NCSX	Status Review
19	6/07	PU	Review of NCSX Cost & Schedule	Status Review
20	8/07	DOE-SC	Technical, Cost, Schedule, ES&H, and Management Review of NCSX	Status Review
21	9/07	DOE-OFES	FESAC Scientific and Programmatic Review	Re-validation of mission need
22	11/07	PU	NCSX Construction Feasibility Review	Validation of construction and assembly plans
23	3/08	PU	Review of the NCSX Project	BCP assist visit
24	4/08	DOE-SC	Technical, Cost, Schedule, ES&H, and Management Review of NCSX	Status Review

L. MAJOR EQUIPMENT INVENTORY

Mothball NCSX Hardware			
Item	Qty	Size	Storage Location
Items from TFTR Test Cell			
Modular Coils	18		
3 pack on wedge	4	8.5' x 9.5'	NCTC
3 pack on pallet	2	8' x 9.5'	NCTC
Vacuum vessel segments	3	11' x 15'	NCTC
VV Spool piece crates	3		NCTC
Yellow wedge stands	2		NCTC
Wedge cover plates		8' x 9'	NCTC
5 ton lift beam	2		RESA
14 ton lift beam	1		RESA
Port extension crates (in RWSE)	6	4' x 10'	NCTC
MC Bolts	2	4' x 4'	NCTCB
Coil winding Station	1	10' x 16'	NCTC
Parts shelves with parts	12	3' x 7'	NCTC
Cabinets	3		NCTCB
Crates	10	2' x 4'	NCTCB
Crates	4	3' x 4'	NCTCB
VV diagnostic parts	1	4' x 4'	NCTCB
Autoclave			D-site pad
Portable AC units	3		C-site crib
Coil winding rooms			Dispose
Small shield block	4		TFTR Test Cell
Large shield block	1		D-site pad
Machine mock-up			NCTC
Welding machines	4		RESA
Tools			C-site crib
Measuring Equipment			S-110
Items from Mockup Bldg			
Equipment in machine shop			RESA
Items from TFTR Basement			
Shelves	1		NCTCB
Cabinets	3		NCTCB
Pallets			NCTCB
Spare coil conductor pallet	5	4' x 4'	NCTCB
Cryo pump skid	1		NCTCB
Cryostat	1		Dispose
Interlocked cryo room	1		Leave in place
Items from D-site yard			
Cable tray stack	10	4' x 15'	D-site pad
Pallet of tray covers	6	4' x 15'	D-site pad

Pallet of brackets	3	4' x 4'	D-site pad
Pallet of grd jumpers/hardware	2	4' x 4'	D-site pad
Items from NCTC/D-site MG			
TF coil crates	16	9'6" x 11'3"	NCTC
Sta 3 fixture crates	2	7' x 7'	NCTC
Items from CAS Bldg			
Aluminum I-beams for platform		6' x 4' x 24'	by CAS
Aluminum tubes for platform		2' x 3' x 24'	by CAS
Finished beams and columns		4' x 4' x 12'	by CAS
Pallet of connector boxes			NCTC
Column end plates			NCTC
From other areas			
Spherical bearings (Dahlgren)	6	1' x 1' x 1'	NCTC
Prototype castings	2	8' x 8'	NCTC
Prototype VV cross sections	2		NCTC
TF coil fabrication fixtures			
VPI fixture	1	11' x 13'	NCTC
Mandrel	1	10' x 11' x 4'	NCTC
Misc fixtures	1	8' x 4'	NCTC
EDP 12/26/08			

PARTS STORED IN THE NCSX TEST CELL – 12/19/08

Modular Coils
 Torroidal Coils (in crates)
 Vacuum Vessel Sectors
 TF WINDING PARTS – 2 BOXES
 COIL FLANGE SHIMS – 2 BOXES
 AL. FEET FOR COILS
 MODULAR & TF COIL EPOXY SAMPLES
 G-11CR BUSHING STOCK FOR COIL FLANGES
 TF VPI MOLD
 TF WEDGE MILLING FIXTURE
 WINDING STATION MOTOR AND CONTROLS
 TF COIL LIFT FIXTURE – LF-273
 TF WINDING / LIFT FIXTURE
 1 SPOOL TF CONDUCTOR
 VVSA BOX #14
 1 BOX FROM MATERIAL TEST LAB.
 1 BOX AUTOCLAVE CONTROL AND JUCTION BOXES
 WIRE ROPE SLINGS
 2 SPARE CASTINGS
 2 VACUUM VESSEL MOCK-UP SECTIONS
 1 BOX CASTING MATERIAL FOR WELD TESTING SAMPLES
 1 BOX SPHERICAL BEARINGS
 AUTOCLAVE BLOWER AND HEATER
 INCH WORM
 STANDS FOR V/V
 CRYO SKID
 COIL CONDUCTOR PAYOUT SPOOL
 1 BOX SPACER & 2 BLANKS – SE121-020
 VVSA BOX #4
 VVSA BOX #5
 P28349 CONTROLS FOR THE 3 ACUATORS

NCSX TEST CELL HARDWARE STORAGE INVENTORY SUMMARY

TOTAL \$65M INVENTORY
 (cost includes design,
 r&d,materials,Fab & assy.
 Excludes management)

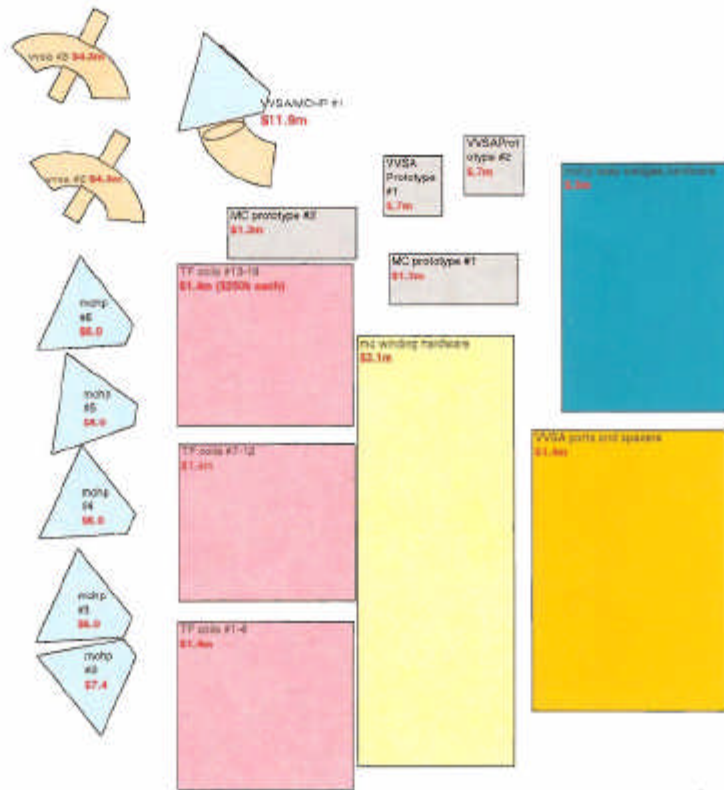

↑
N

NCSX TEST CELL LOOKING TOWARD SE CORNER

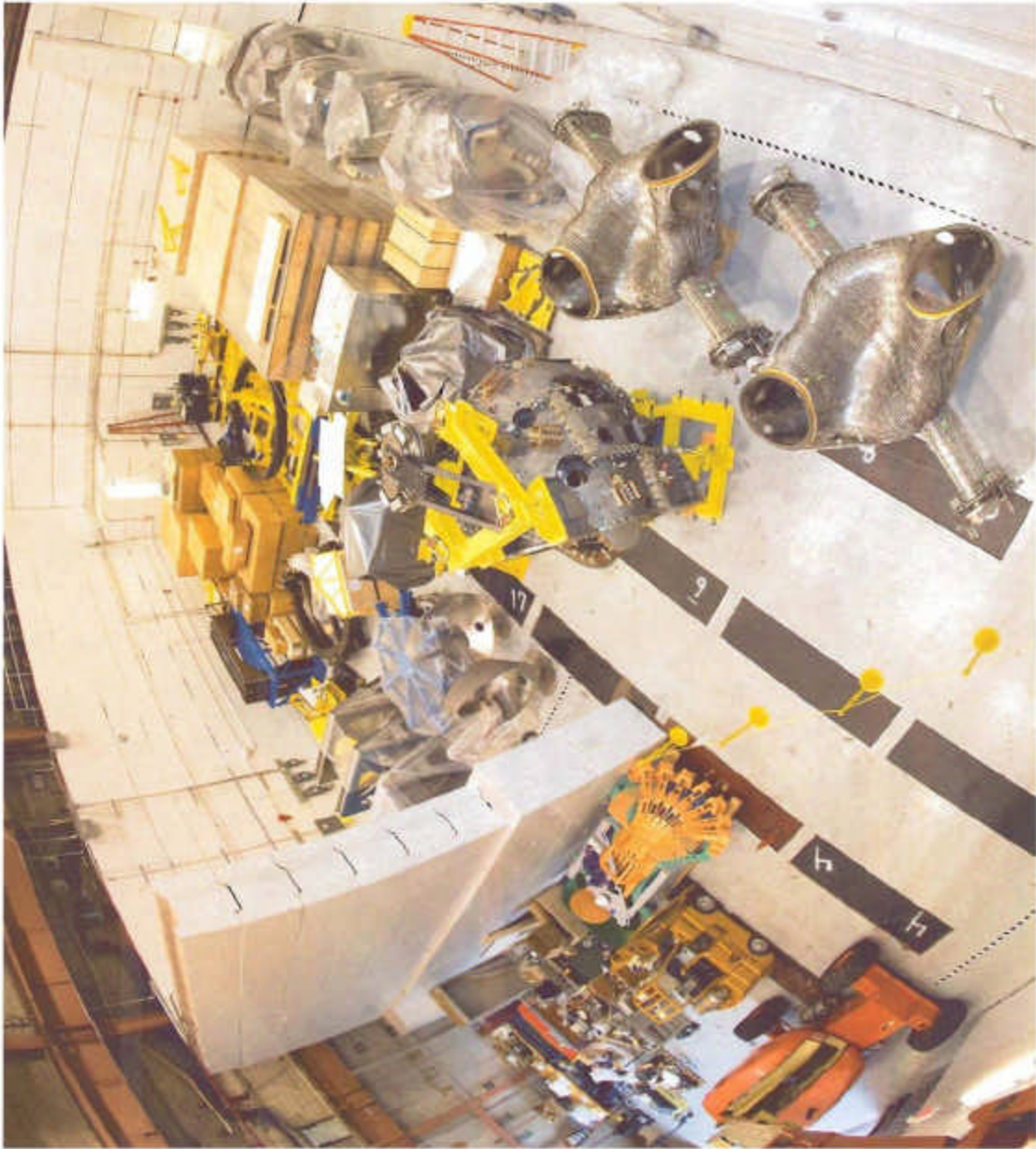

NCSX PARTS STORED IN CS BASEMENT NORTH END – 12/19/08

1. Coil alignment fixtures, stainless and aluminum shims, trial shear plate sets
2. Hillman rollers- coil to vessel, 2 piece aluminum bushings, stainless hex mounting
3. Coil winding parts
4. NCSX VV brackets
5. Small pallet 310# of spare copper for chill plates
6. Mounting brackets for turning wheels
7. Mounting brackets & turning fixture wheels
8. Delrin push pads, side bars, tees, winding tools, 1/4" tinned tubing, N₂ for tooling, VPI valve manifolds
9. Winding equipment (cannot read manifest)
10. VPI manifolds and fittings & valve assembly, manifold mounting bracket
11. Coil winding parts
12. Bonding glass types, ground-wrap, kapton tape
13. PF1A
14. Surveyed side bars and tees
15. Twisted race tracks
16. Autoclave manifolds (clean)
17. Turning Fixture motor & Gears controls
18. Counter weights for coil rings
19. VPI sideboards and tees
20. Heavy steel plates
21. Winding clamp, sidebars, shim washers, G10 Threaded Rod, G10 thread washers
22. Excess casting material
23. Romer Arm Stand
24. Romer Arm Stand
25. Electrical tray hardware, bolts and nuts, tray connectors
26. NCSX copper conductor 8 full spools
27. A, B, C style coil floor stands
28. NCSX VVSA
29. Partial copper conductor spools
30. Partial copper conductor spools
31. Partial copper conductor spools
32. Partial copper conductor spools
33. Winding fixture motor
34. Control box
35. Co-joined taping machine, G11 CR, jumper leads, ground-wrap, stud alignment tool
36. TF coil test mold, TF coil test bundles
37. Coil lacing test fixture
38. strain gauges, thermocouples, poloidal break stuff, shrink tube
39. FG tapes and G11 Fillers
40. FG tapes and Leads
41. University of Tennessee (small box)
42. Shim bags LN₂ cooling tubes, fittings and gauges
43. Grey Locker #1: final clamps
44. Grey Locker #2: hot plate, scale
45. Grey Locker #3: binks tank parts





M. DATA ARCHIVING

The NCSX project was cancelled on May 22, 2008 at which time the Office of Science directed an orderly close-out of activities. At this time, the NCSX Project was in various stages of design, component fabrication, and assembly. To safeguard the Department's investment, an orderly close-out was initiated that allowed some work packages to complete to an optimal break point or to a point that demonstrated risk reduction. As part of the project closeout activities, all project data and documentation, including status notes of work in progress, were systematically collected and organized for long-term storage. If the project were to be re-started, this information would be very valuable to the project team. The goal of the NCSX documentation archive caretaking activity is to safeguard the Department's investment in the NCSX Project prior to project cancellation and close-out. The archive focuses on capturing and maintaining intellectual knowledge, design and construction information (i.e., soft data) that has been performed and providing proactive management to ensure the data is secured for retrieval. Specifics of the data archiving approach can be found in the NCSX Data Archiving Plan (NCSX-PLAN-DAP-00 draft C). In April 2009 a review of the NCSX data and documentation archive was conducted by an independent team led by the PPPL Manager of Quality Assurance. This review addressed the following charge questions;

1. Is the content sufficiently complete? What's missing?
2. Does the index logic enable rapid location and retrieval of specific information?
3. Are storage media (both electronic and hard copy) adequately protected against damage and loss for a period up to 15 years?
4. Are the risks of software obsolescence adequately assessed and mitigated for the first 5 years?
5. Are plans for managing and caretaking of this archive?
6. Is the NCSX Documentation Archiving Plan complete and address all the issues above? Should the Archiving Plan be reviewed/revised after 5 years to support a graded approach for longer term archive period up to 15 years?

While the findings and recommendations of this review are documented in "9016_NCSX_Data_Archiving_review" it is noteworthy to state that an on-going proactive data caretaking initiative will be undertaken to ensure the data and documents safeguarded.

N. PUBLICATION of NCSX ACCOMPLISHMENTS

Throughout its history, the NCSX project published papers at conferences documenting its progress. Papers documenting the physics basis were published both at conferences and in refereed journals. However, the project's unique and innovative contributions to engineering science were under-reported in the literature, a consequence of the project's historical emphasis on schedule performance and problem-solving over publication. With the cancellation of the project short of completion, there was a risk that the project's contributions to fusion engineering science would be lost unless a concerted effort were made in the closeout phase to publish its accomplishments. With DOE's strong support, a new work package was opened and budgeted to support manuscript preparation and conference participation as part of the closeout plan. During this period, several papers on NCSX engineering were given at major conferences, several of which were submitted to refereed conference proceedings.

L. Dudek, et al., "Status of the NCSX Construction," 25th Symposium on Fusion Technology (SOFT), Rostock, Germany, 15-19 Sept., 2008. Published in *Fusion Engineering and Design* **84** (2009) 351–354.

G. H. Neilson, et al., "Engineering Accomplishments in the Construction of NCSX," 18th Topical Meeting on the Technology of Fusion Energy (TOFE), San Francisco, CA, 28 Sept. - 2 Oct. 2008. Submitted for publication in *Fusion Science and Technology*.

P. J. Heitzenroeder, et al., "Design and Construction Solutions in the Accurate Realization of NCSX Magnetic Fields," paper FT/P3-8 at 22nd IAEA Fusion Energy Conference, Geneva, Switzerland, 13-18 October, 2008.

Robert T. Simmons, et al., "Systems Engineering and Risk Management on the National Compact Stellarator Project (NCSX)," American Institute of Chemical Engineers Annual Meeting, Philadelphia, PA, November 2008.

R. T. Simmons, et al., "Risk Management on the National Compact Stellarator Project (NCSX)," American Association of Cost Engineers, Annual Meeting, Seattle, WA, 28 June – 1 July 2009.

Robert T. Simmons, "Data and Configuration Management Challenges on the National Compact Stellarator Experiment (NCSX)," Association for Configuration and Data Management, Annual Technical and Training Conference, Lake Buena Vista, FL, March 23-25, 2009.

Papers presented at 23rd IEEE Symposium on Fusion Engineering (SOFE), San Diego, CA, 1 – 5 June 2008.

- G. W. Labik, S. P. Gerhardt, B. C. Stratton, L. J. Guttadora, “High Temperature Rogowski Coil for the National Compact Stellarator Experiment.”
- M. R. Kalish, A. Brooks, J. Rushinski, R. Upcavage, “NCSX Trim Coil Design.”
- L. E. Dudek, J. H. Chrzanowski, K. Freudenberg, G. Gettelfinger, P. Heitzenroeder, S. Jurczynski, M. Viola, “Testing of Compact Bolted Fasteners with Insulation and Friction-Enhanced Shims for NCSX.”
- M. Denault, M. Viola, W. England, “Low Distortion Welded Joints for NCSX.”
- T. Dodson, C. Priniski, S. Raftopoulos, D. Stevens, R. Ellis, M. Viola, “Advantages of High Tolerance Measurements in Fusion Environments Applying Photogrammetry.”
- R. L. Strykowski, “Engineering Cost & Schedule Lessons Learned on NCSX.”
- J. H. Chrzanowski, P. J. Fogarty, T. G. Meighan, S. Raftopoulos, L. E. Dudek, “Lessons Learned During the Manufacturing of the NCSX Modular Coils,”
- P. L. Goranson, L. E. Dudek, K. D. Freudenberg, G. W. McGinnis, M. C. Zarnstorff, “Application of High-Performance Aerogel Insulating Materials (Analysis & Test Results).”
- M. E. Viola, J. W. Edwards, T. G. Brown, L. E. Dudek, R. A. Ellis, P. J. Heitzenroeder, R. L. Strykowski, M. Cole, “Accomplishments in Field Period Assembly for NCSX.” (invited)
- K. D. Freudenberg, M. J. Cole, D. E. Williamson, P. Heitzenroeder, L. Myatt, “Performance Evaluation and Analysis of Critical Interface Features of the National Compact Stellarator Experiment (NCSX).” (invited)
- C. Priniski, T. Dodson, M. Duco, S. Raftopoulos, B. Ellis, A. Brooks, “Metrology Techniques for the Assembly of NCSX.”
- R. Ellis, A. Brooks, M. Duco, S. Raftopoulos, C. Priniski, T. Dodson, M. Viola, “Dimensional Control of NCSX Field Period Assembly.”
- P. J. Fogarty, M. J. Cole, R. D. Benson, J. W. Campbell, J. R. Holder, G. L. Lovett, “NCSX Risk Mitigation and Tooling for Limited Access Assembly.”

- G. H. Neilson, C. O. Gruber, D. J. Rej, R. T. Simmons, R. L. Strykowski, “Lessons Learned in Risk Management on NCSX.” (invited). Submitted to special issue of Transactions on Plasma Science.

O. ENGINEERING CHANGE PROPOSAL (ECP-60): PROJECT CLOSEOUT

Final project scope as documented in Engineering Change Proposal (ECP)- 60 “NCSX MIE Project Closeout”, was completed in June 2009. The CD-4 Level I milestone was defined in ECP-60 to represent completion of scope completed through project termination plus tasks identified in the project closeout plan. Specific task deliverables included;

- Inventory and store all materiel and fabricated components
- Complete fabrication of 18 modular coils
- Complete fabrication of 18 toroidal field coils
- Complete coil structures final design review
- Complete the LN2 distribution system PDR, trim coil , and base structure FDR
- Complete subassembly of two half field period assemblies (HFPA) & one HFPA trial fit-up test over vacuum vessel subassembly
- Document final status of CAD models, finite-element analyses, and all work packages, including open issues needing to be resolved in order to complete construction.
- Archive key project documents for long-term storage electronically, and make those documents readily accessible to the research community
- Prepare journal manuscripts on physics, engineering design, integration, R&D, fabrication, assembly, management, and lessons learned (OPC)

Final Project Milestone status

ECP-60 Milestones			
	<i>Milestone</i>	<i>Planned</i>	<i>Actual</i>
Level I			
	CD-4	Jul-2009	Jun-2009
Level II			
	All TF Coils Delivered	Oct-2008	Sep-2008
	Modular Coil Fabrication Complete (last VPI)	Aug-2008	Jul-2008
	3 modular coils assembled	Oct-2008	Aug-2008
	Modular Coil Half Period test fit over VVSA	Nov-2008	Aug-2008
	Modular coils and TF coils in safe storage	Mar-2009	Dec-2008
	Technical Data Collection complete	May-2009	Apr-2009

P. PROJECT TERMINATION & CLOSEOUT COMPLETION DOCUMENTATION

**Statement by Dr. Raymond L. Orbach
Under Secretary for Science and Director, Office of Science
U.S. Department of Energy
May 22, 2008**

Future of the Princeton Plasma Physics Laboratory (PPPL)

In late 2006, it became clear that National Compact Stellarator Experiment (NCSX) construction project would not be able to meet its approved baseline total project cost of \$102M or its completion date of July 2009. Since then, DOE, Princeton University, and PPPL have worked extensively together to understand the issues and plot a course of action that maximizes the benefits for the scientific community and the taxpayers, and ensures an exciting path for PPPL research well into the future. Following several internal and external reviews over the past 18 months, it has been concluded that the budget increases, schedule delays and continuing uncertainties of the NCSX construction project necessitate its closure, and that PPPL's future as a world-leading center of fusion energy and plasma sciences is more assured by a renewed focus on the successful Spherical Torus confinement concept.

The Office of Science always weighs the scientific benefits to be obtained from facilities against the cost to the taxpayer – in this case the escalating costs and remaining uncertainties make continuation of the construction project untenable. The latest cost estimate is \$170M with an August 2013 scheduled completion. An Office of Science review (April 2008) concluded that the project has not yet met the requirements needed to approve a new baseline cost and schedule. This puts the future of research at PPPL in unnecessary peril, and increases the burden on the DOE fusion energy sciences program. It would require the premature closure of the Spherical Torus experiment (NSTX), a proven, productive, world-leading scientific facility, while creating an uncertain gap in research capabilities at PPPL. This would result in a loss of opportunities for a large number of collaborators in the research community and constrain the ability to start new initiatives during the ITER era.

The highest priority of the U.S. fusion program is participation in the international ITER burning plasma experiment, which is based on the tokamak concept. The Spherical Torus is closely related to the tokamak, and experiments planned for the next several years in the NSTX facility promise many exciting discoveries that should directly impact our ability to understand the new plasma regimes expected in ITER. The Spherical Torus may also prove to be a prototype for the next step for the U.S. domestic fusion program. Proposed upgrades for the Spherical Torus experiment at PPPL can keep this facility at the forefront of fusion science research in the world well into the future. As such, a concentration on the Spherical Torus better positions PPPL to remain a center of excellence for fusion energy and plasma sciences, and thereby compete for new areas of leadership in the future fusion program.

Closure of the Compact Stellarator construction effort will be managed to capture many benefits of the project. PPPL will complete the special modular and toroidal field coils in FY 2008. A modest engineering effort will document the R&D achievements to date, and continue to retire remaining risks of the Compact Stellarator design to allow revisiting this particular design if future developments in the fusion program warrant it. In addition, the U.S. fusion program will increase its investments in theory and smaller focused experiments on stellarator concepts to maintain its interest in future development of these exciting plasma confinement concepts.

We believe this decision is in the best interests of the American fusion program PPPL and Princeton University. Our decision reflects our strong commitment to the future of PPPL as a center of scientific excellence, including the prospect that it will compete successfully for opportunities to extend its work in plasma and fusion science in a number of important and promising new directions.

Record of Decision Memo



Department of Energy
Washington, DC 20585

MEMORANDUM FOR UNDER SECRETARY FOR SCIENCE

FROM:

for Stephen Eckstrom
RAYMOND J. FONCK, ASSOCIATE DIRECTOR
OFFICE OF FUSION ENERGY SCIENCES

SUBJECT:

ACTION: Rebaseline or cancel the National Compact Stellarator Experiment (NCSX) Major Item of Equipment (MIE) project at Princeton Plasma Physics Laboratory (PPPL)

ISSUE:

The NCSX project Performance Baseline was initially approved at Critical Decision (CD)-2 with a Total Project Cost (TPC), including conceptual design, of \$96 Million (M) and completion in May 2008. The current NCSX project has an established baseline with a TPC of \$102M with a CD-4 completion date of July 2009. After PPPL, with support from Oak Ridge National Laboratory (ORNL), evaluated the project performance to date and performed a "bottoms up" estimate to complete, a new baseline was proposed with a TPC of \$170.2M and a completion date of August 2013.

RECOMMENDATION: After extensive evaluation of the past performance and future expectations of the NCSX MIE fabrication, which is documented in the attached Appendix, I recommend that the Under Secretary cancel the NCSX MIE for the following reasons:

- 1) the NCSX initial pre-CD-0 costs have increased from the \$50-60M range first considered by the Fusion Energy Sciences Advisory Committee (FESAC) to the current estimated cost of \$170.2M and the date for finishing the project has been delayed from 2007 to 2013;
- 2) the NCSX will need an additional \$30-40M and 1-2 years after 2013 to achieve useful physics operation;
- 3) there is a significant possibility that the NCSX TPC could increase further due to the inadequate, preliminary stage of some of the design work, and the lack of machine assembly experience;
- 4) cancellation will clarify PPPL's future, allow significant upgrades to the National Spherical Torus Experiment (NSTX), if NCSX funds are redirected, and eliminate the "standing army" problem; and



Printed with soy ink on recycled paper

5) there is a need to avoid further damage as we move the program into the era of support of burning plasma physics.

APPROVE: Raymond T. Aback

DISAPPROVE: _____

DATE: July 9, 2008

**PROJECT CLOSEOUT REPORT
NATIONAL COMPACT STELLARATOR EXPERIMENT
(NCSX)**

AUGUST 2009

**Donald
J. Rej**

Digitally signed by Donald J. Rej
DN: cn=Donald J. Rej, o=Los
Alamos National Laboratory,
ou=Science Program Office,
email=drej@lanl.gov, c=US
Date: 2009.08.13 08:09:42
-06'00'

**Ronald L.
Strykowski**

Digitally signed by Ronald L.
Strykowski
DN: cn=Ronald L. Strykowski,
o=Princeton University, ou=PPPL,
email=rstrykow@pppl.gov, c=US
Date: 2009.08.12 10:51:08 -04'00'

Prepared by Donald J. Rej &
Ronald L. Strykowski

NCSX Project Managers
Princeton Plasma Physics Laboratory

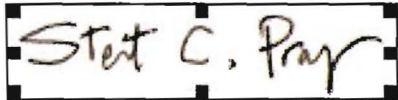

Submitted by Stewart Prager
Director
Princeton Plasma Physics Laboratory

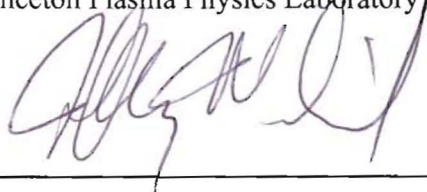

Approved by Jeffrey Makiel
DOE Federal Project Director for the
National Compact Stellarator Experiment