

Peer Review for Modular Coil Winding Form Selected Issues

**B. Nelson, D. Williamson, A. Brooks, HM Fan, M. Cole and
the WBS-1 Design Team**

**NCSX Peer Review
January 23, 2003**

Outline

- **Introduction to NCSX modular coil design**
- **Purpose of review**
- **Review elements:**
 - **Poloidal electrical break**
 - **Cooling configuration:**
 - **Tolerances**
 - **Schedule**
- **Other features to be added to modular coil winding form model**
- **Summary**

National Compact Stellarator Experiment **NCSX**

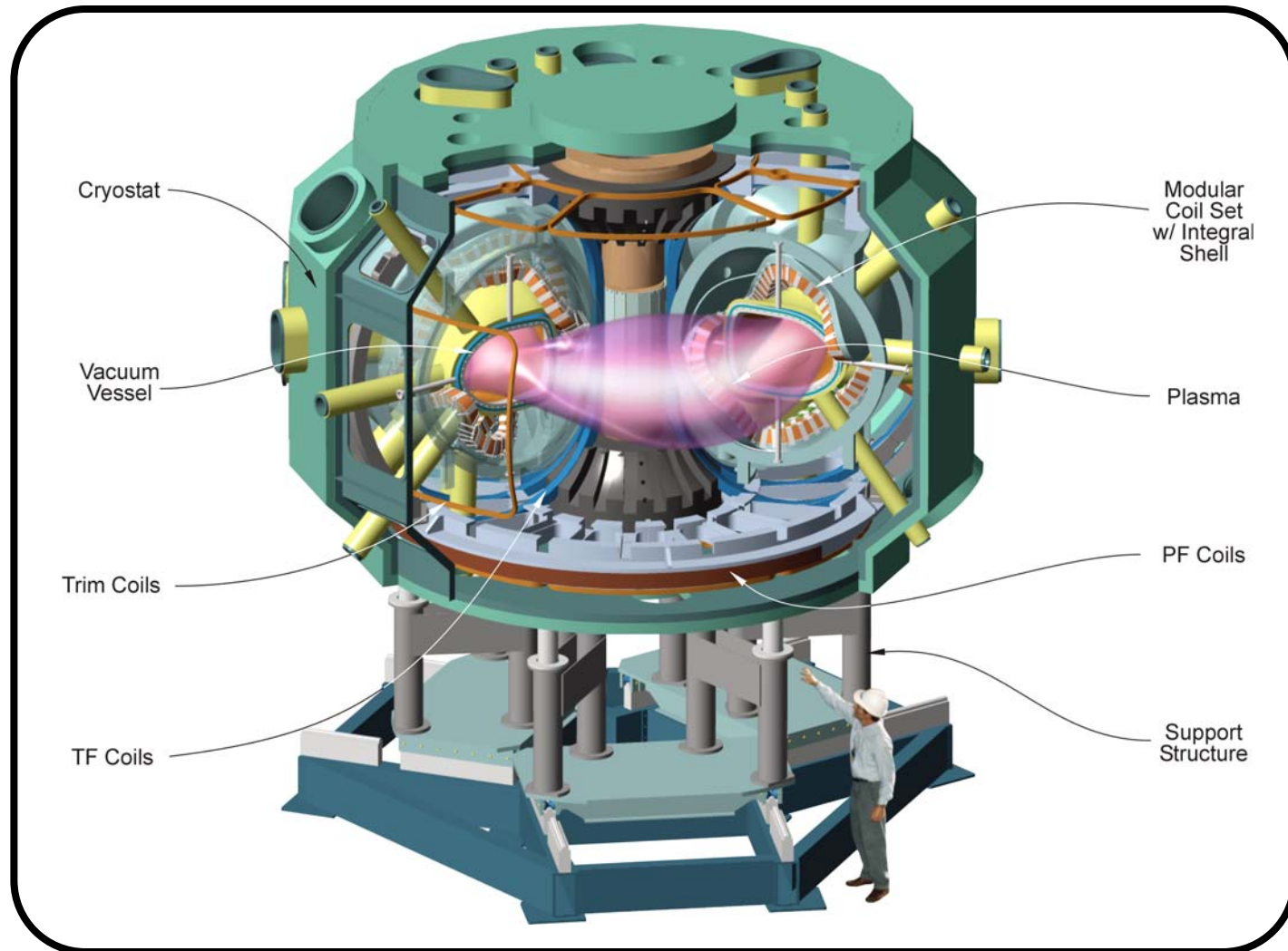

NCSX Coil Set Assembly

Coil set	Function:
Modular coils	Basic quasi-axisymmetric magnetic configuration
PF coils	Inductive current drive, plasma shaping
TF	Addition or subtraction of toroidal field for control of magnetic transform
Trim coils	Control of magnetic flux surface quality

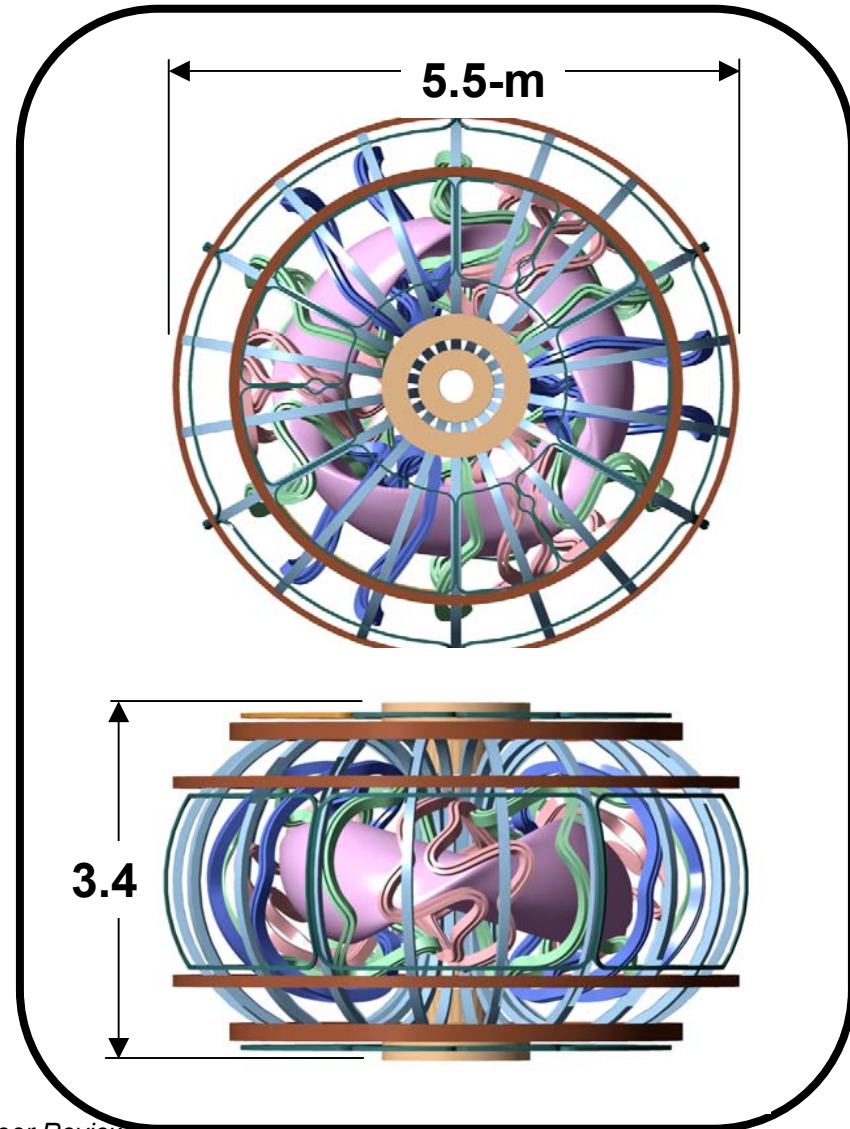

NCSX Modular coil configuration

- 18 coils, 3 field periods, 3 coil types
- Optimized for physics performance consistent with NBI access and engineering constraints.
- Coils wound with flexible cable conductor into cast-and-machined forms
- Coils pre-cooled to LN₂ temperature to allow high current density (14 kA/cm²)

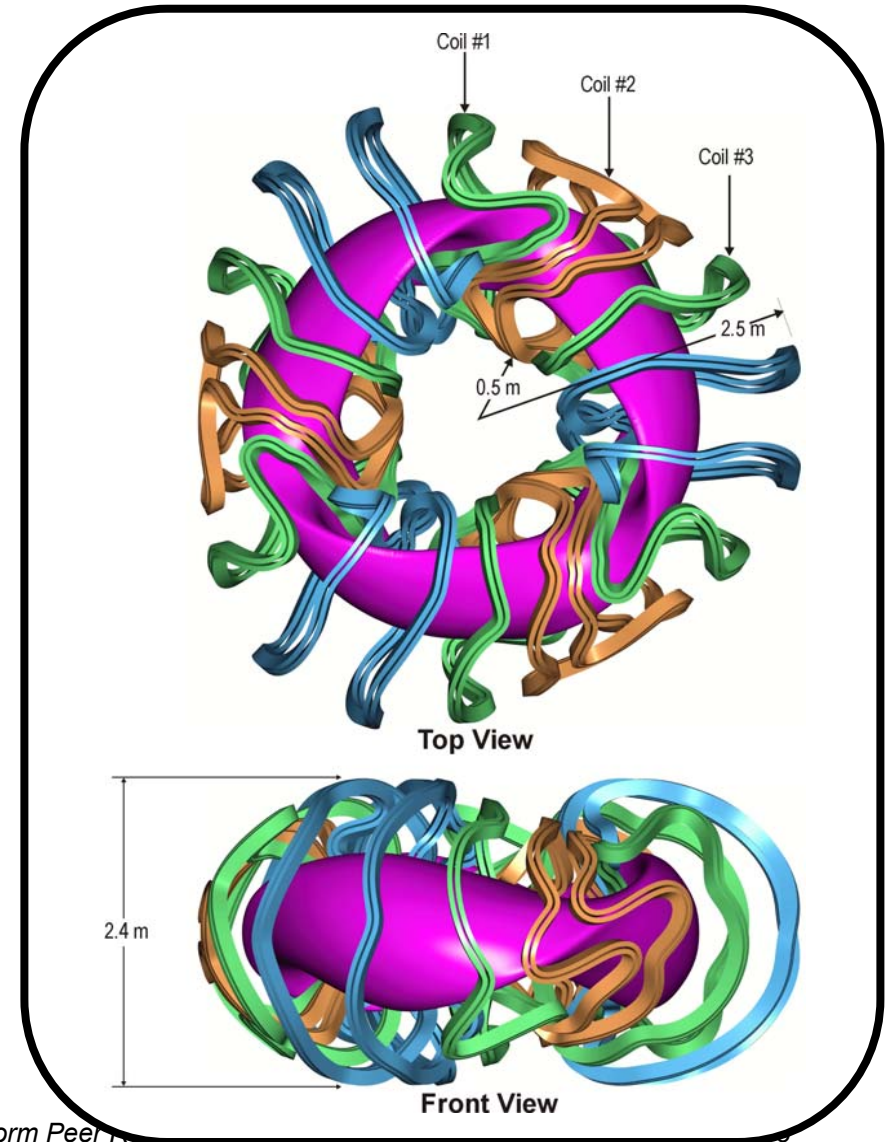

Continuous shell forms robust structure

- Shell consists of individual modular coil forms that are bolted together
- Penetrations for access are provided wherever needed
- Thickness can be varied to optimize / reduce stresses
- Provides machine base for other components
- Stellarator symmetry preserved, at least one toroidal break per field period

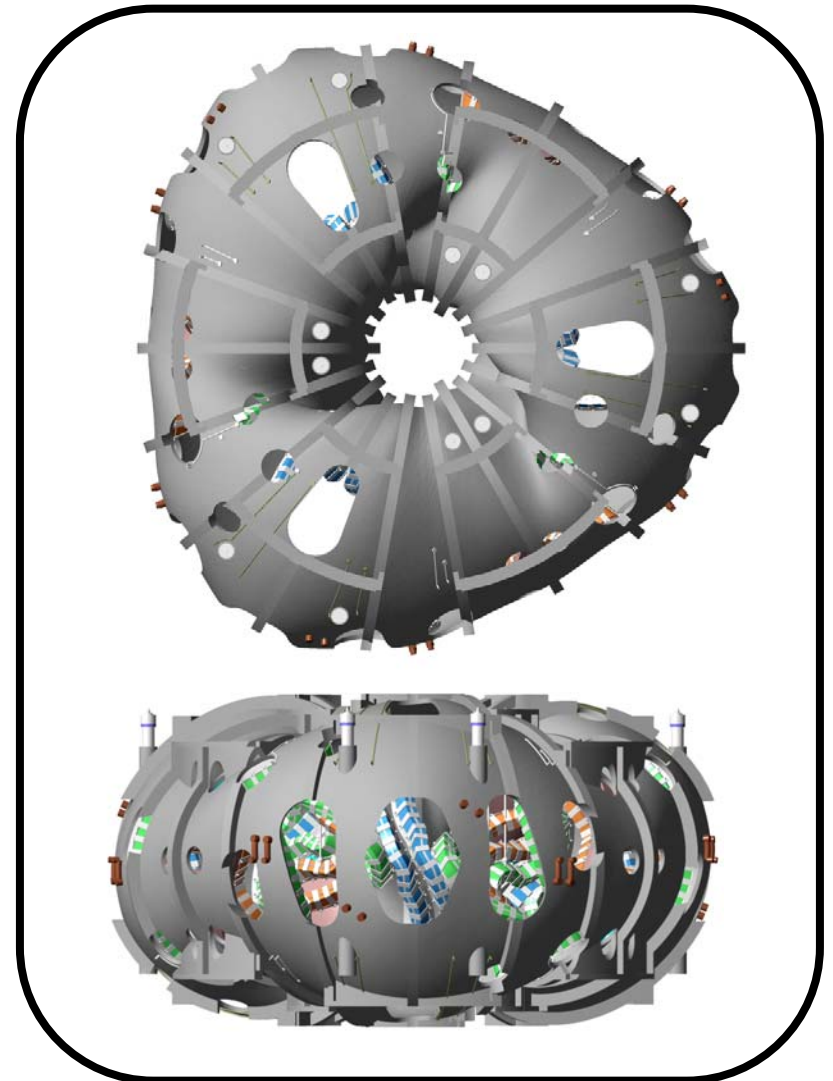

Modular coil manufacturing sequence

- Continuous support for strength and accuracy of windings
- Single machined part provides winding form and assembly features
- Winding never removed from coil form

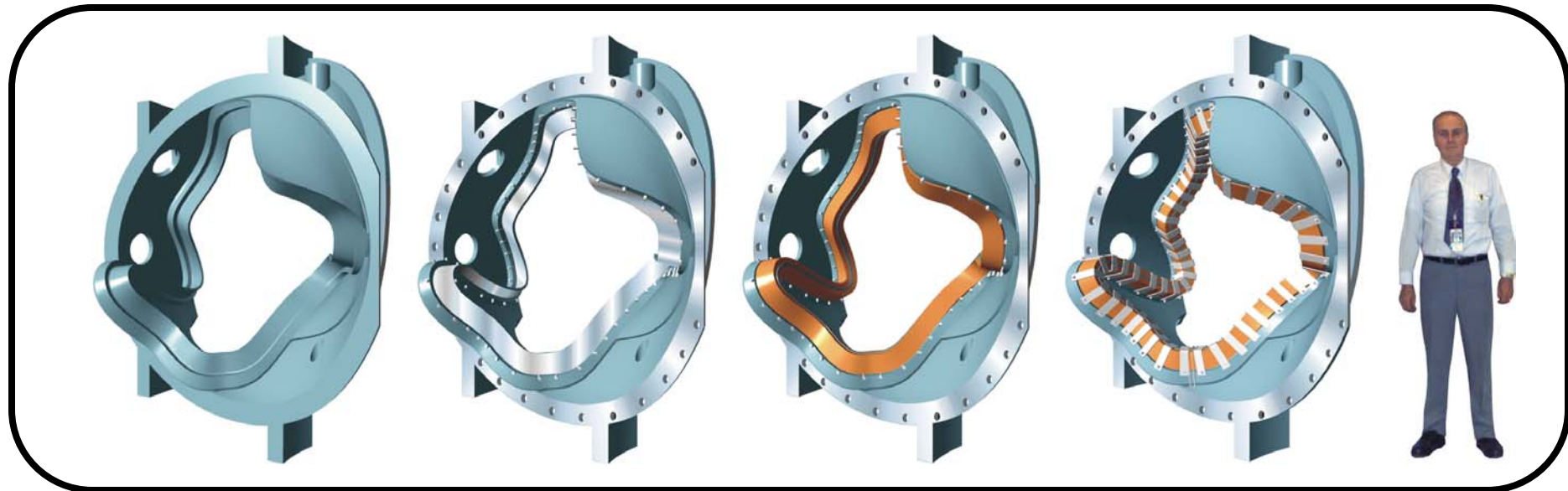

Rough casting

Features are
machined

Conductor
wound directly
into structure

Auxiliary
support
clamps are
installed

NCSX Modular coils wound with flexible cable directly on coil structure

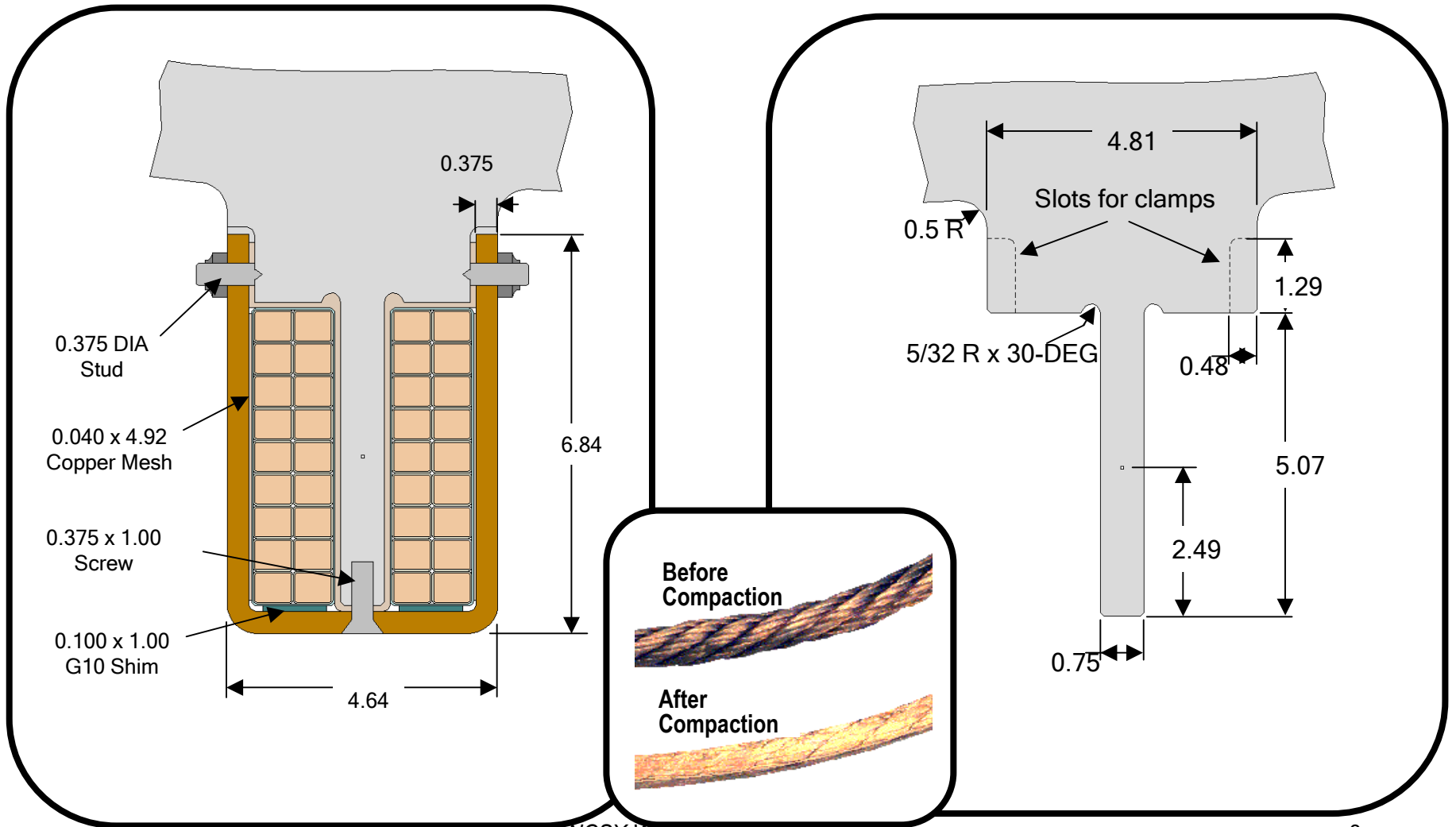

R&D is planned to reduce risk

- **Manufacturing studies (complete)**
- **Epoxy impregnation tests and conductor characterization**
- **Winding tests on full scale form**
- **Full scale prototype winding form (from two suppliers)**
 - **Contracts will be awarded soon**
 - **Details of winding form must be finalized, in conjunction with suppliers**
- **Full scale prototype coil**

Purpose of Review

- **Poloidal electrical break**
 - *Is poloidal electrical break feasible, and what are cost impacts?*
- **Cooling configuration:**
 - *Is approach to developing a cooling scheme reasonable?*
 - *Who should manufacture / install conduction layer, and how?*
- **Tolerances:**
 - *What is tolerance requirement?*
 - *Is tolerance budget / division reasonable?*
- **Other features to be added to modular coil winding form model**
- **Schedule Is near term plan sufficient to support procurement?**

Poloidal break - Requirement

- Time constant of shell must be less than 20 ms to allow fast flux penetration and to avoid persistent induced currents and resulting error fields
- Baseline design had > 50 ms time constant without breaks
- 3-D Analysis [Art Brooks] used to evaluate options for reducing time constant

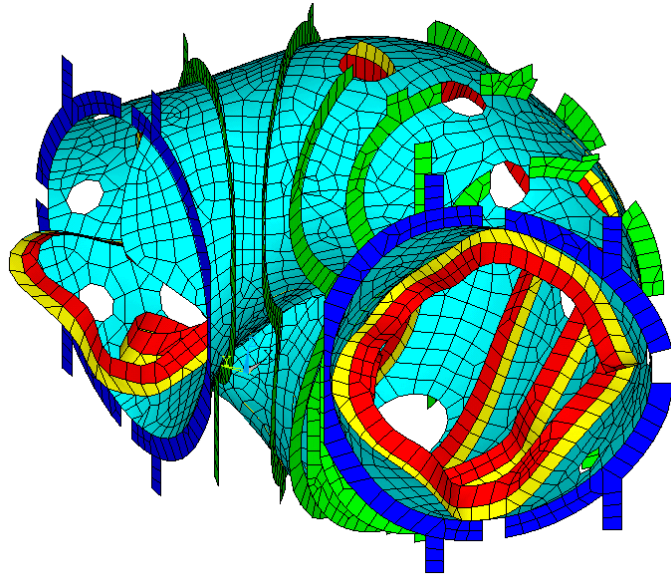

FEA model

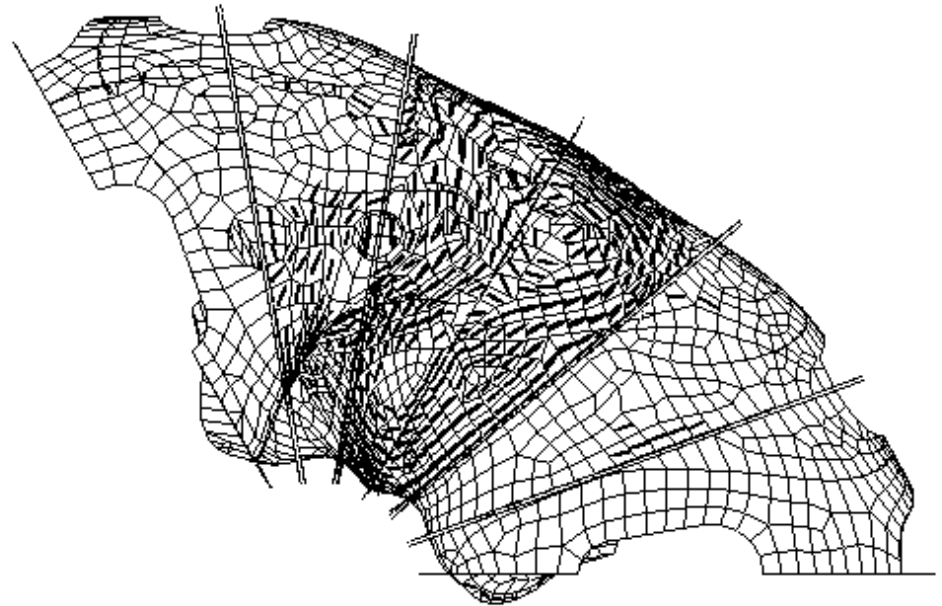

SPARK analysis

Poloidal break - proposal

- Time constant of shell whittled down to < 20 ms
 - Cut, insulate and bolt poloidal break prior to final winding path machining
 - Copper conducting layer insulated from casting, and segmented
 - All toroidal flanges except final field joints electrically insulated

Poloidal break line

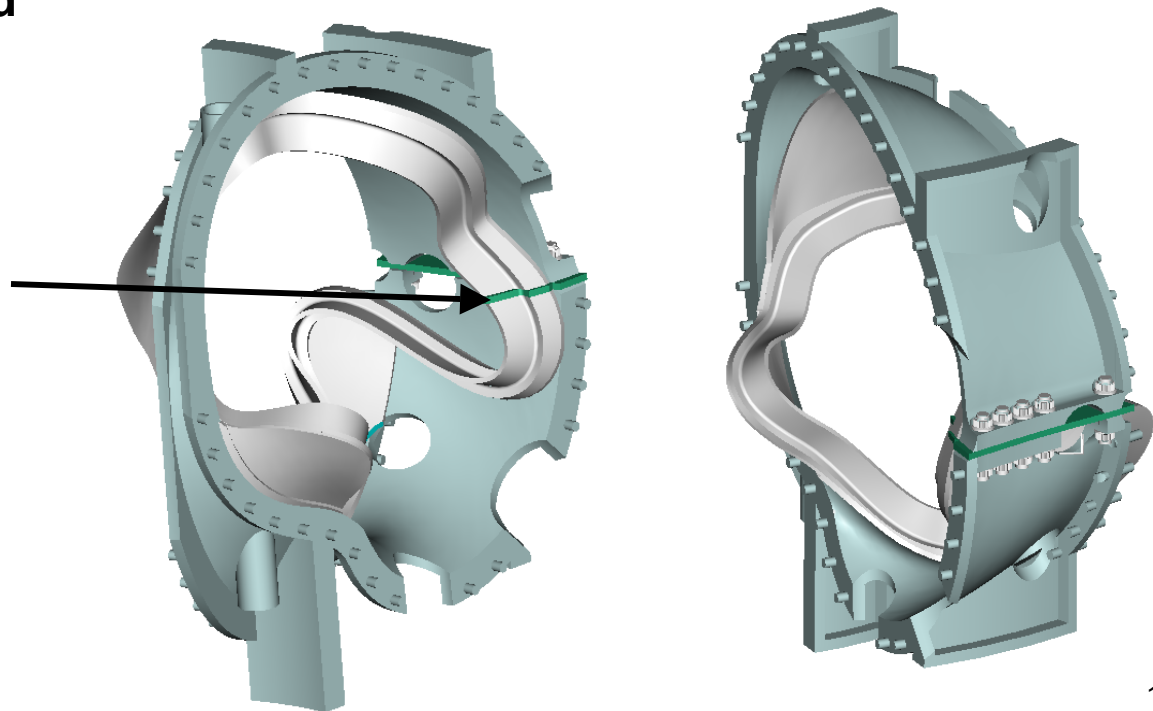

Poloidal break – Type A coil

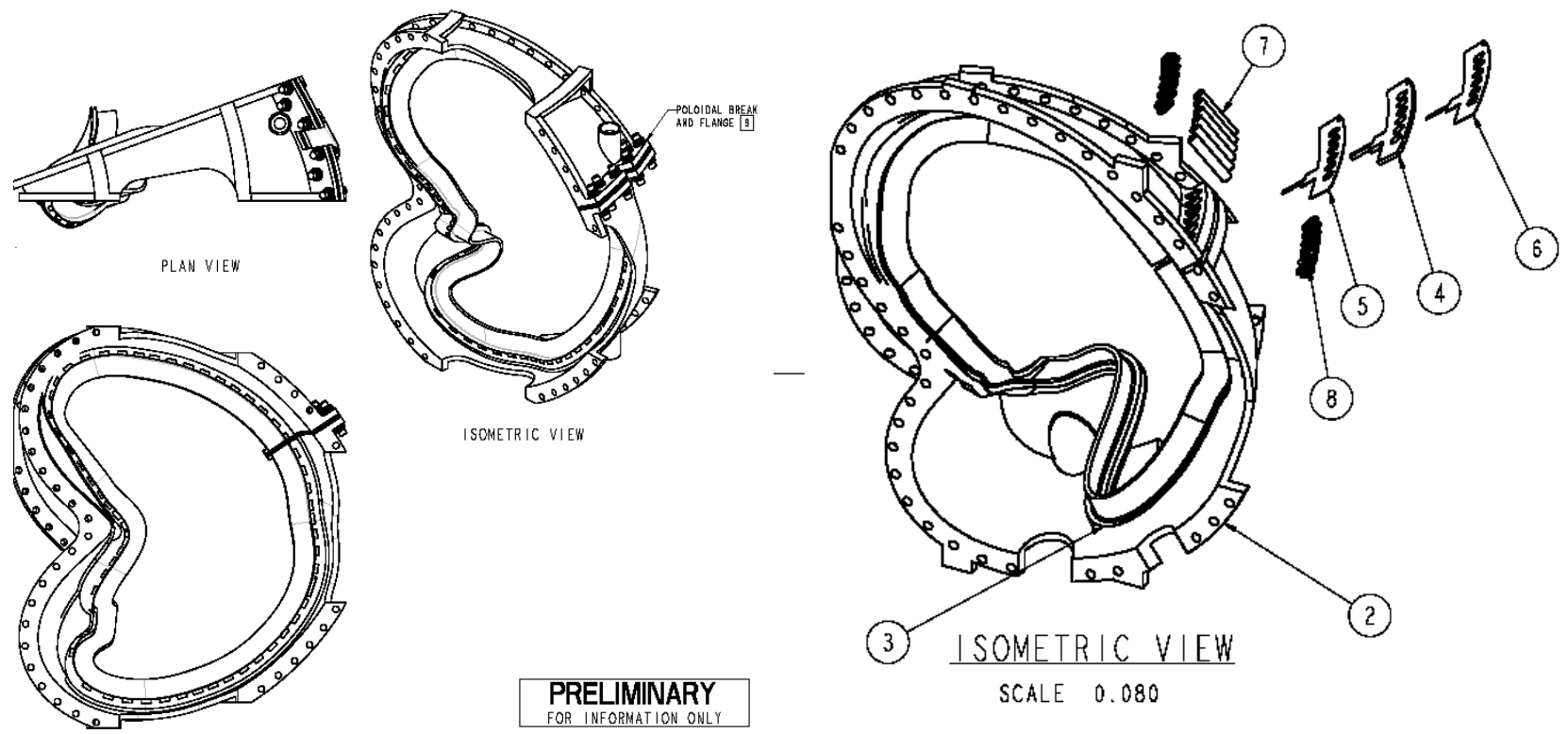

Baseline option for connection of tee web across break

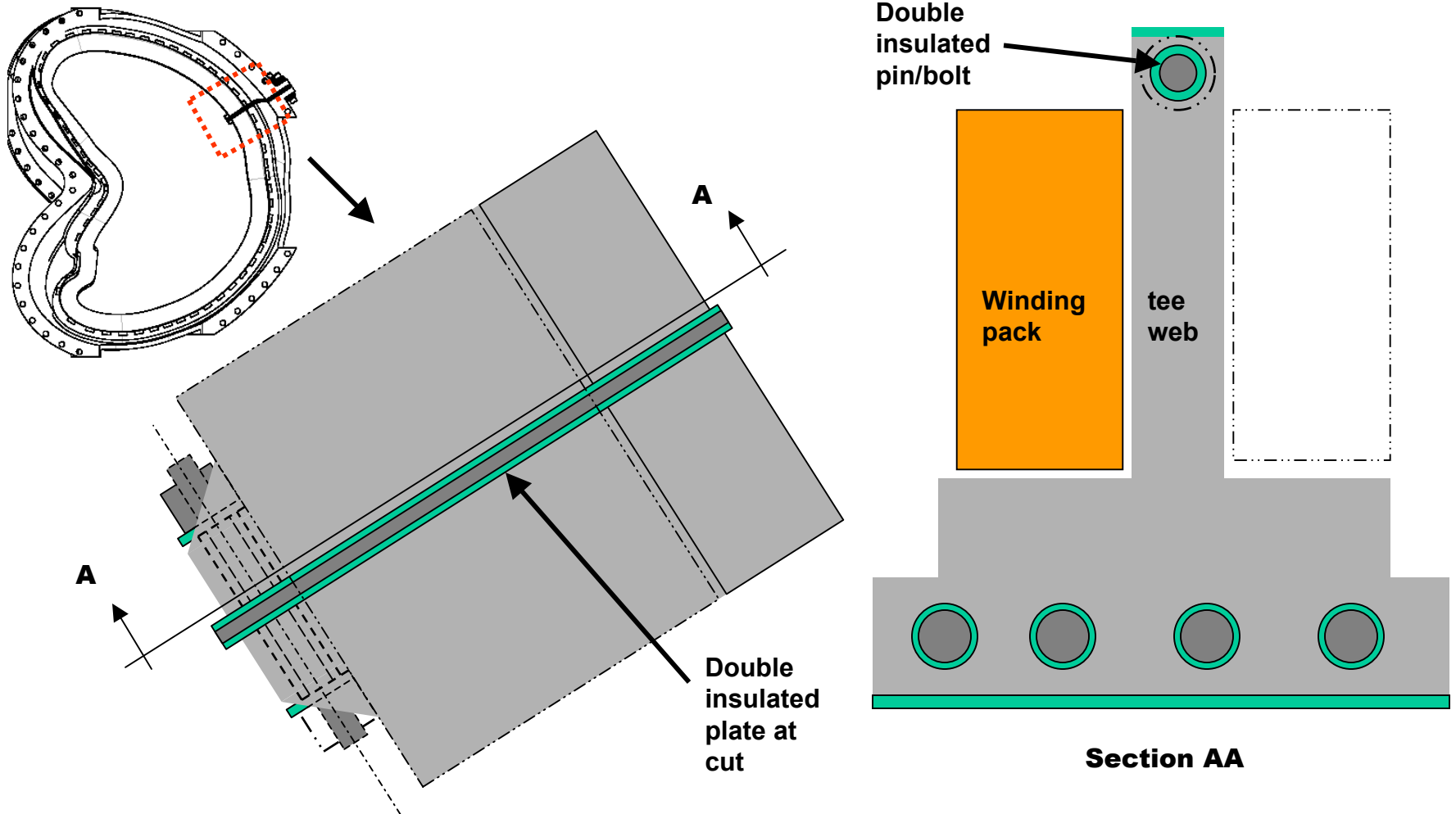

Poloidal break – What about stresses?

- Structure analyzed for worst case magnetic loads, w/o breaks [ref. HM Fan]
- Shell structure well within limits
 - Max Equivalent ~ 90 Mpa (13 ksi)
 - Regions near breaks ~ 40 MPa

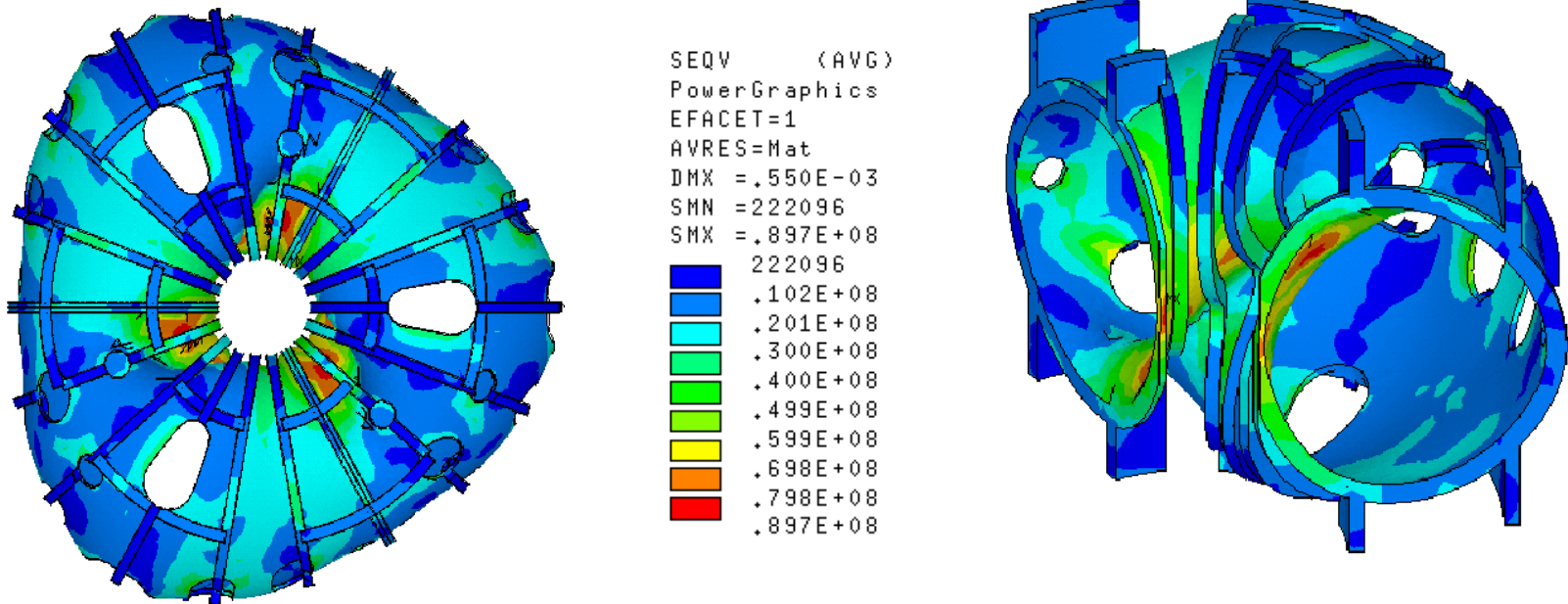

Poloidal break – What about stresses?

- “Tee” structure plotted separately, indicates general von Mises stress level < 50 Mpa in outboard region for worst case loading
- Net lateral loads on “tee” are primary concern, but these are lower in outboard region, go through several inflection points

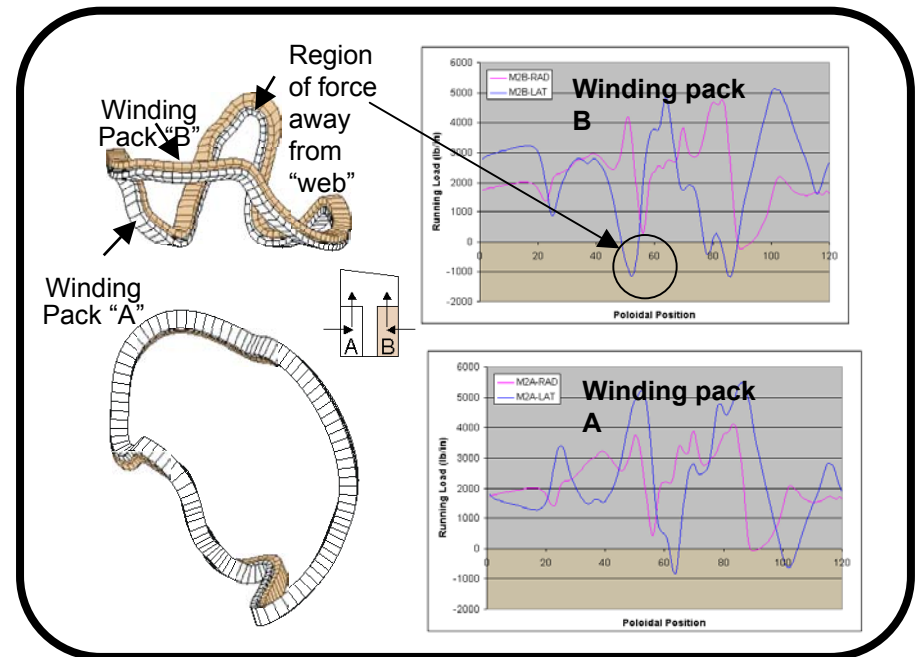
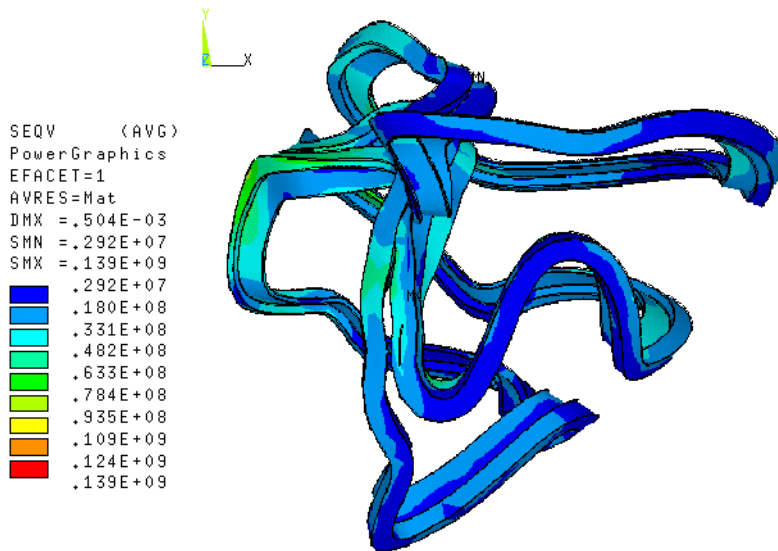

Lateral EM Load, Coil M1

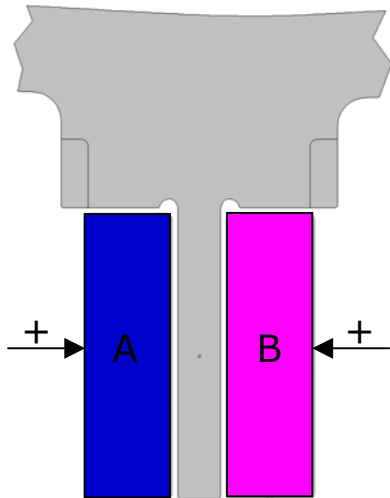
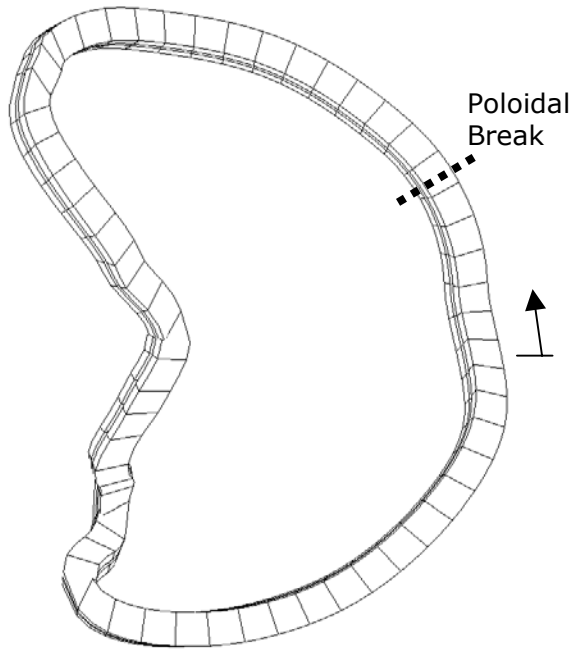

23 Jan

NCSX Windin

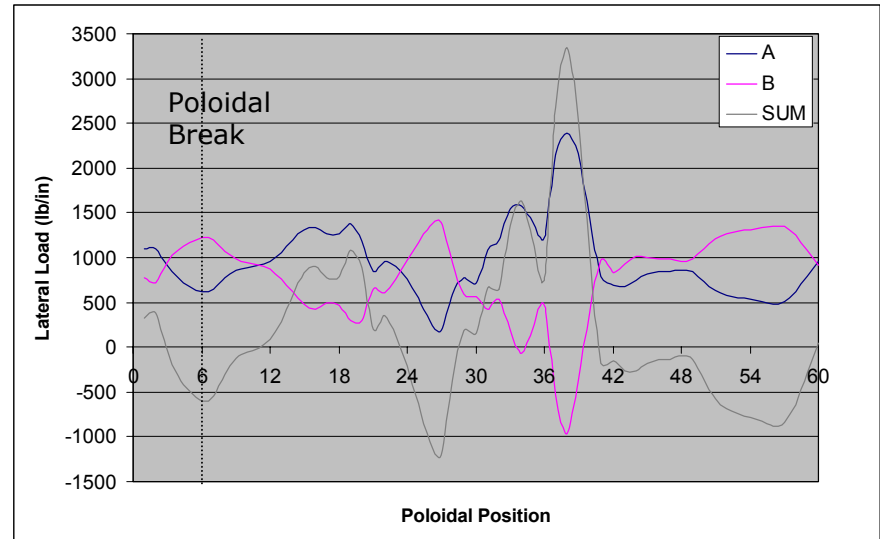

Case: PDR coilset, modular coils only, 1.7-T

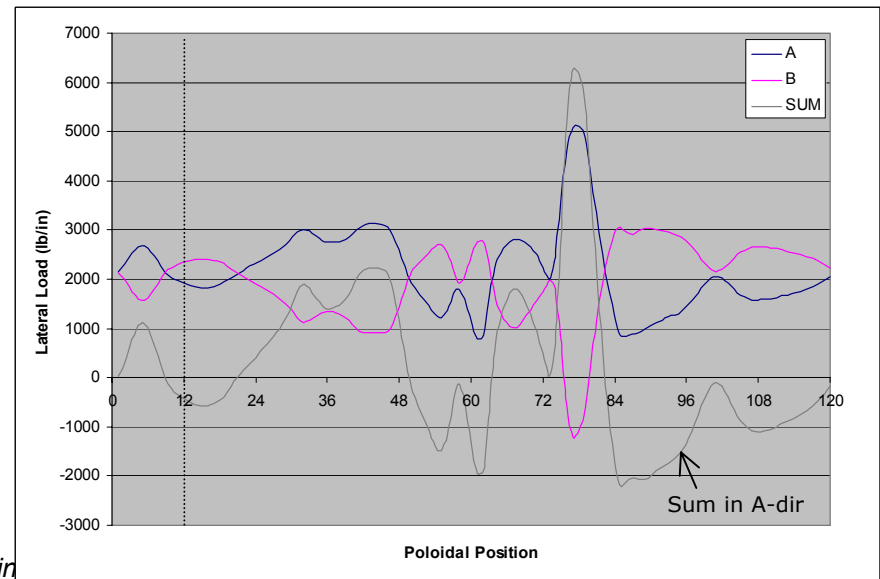

Case: CDR coilset, all coils, 2-T

Lateral EM Load, Coil M2

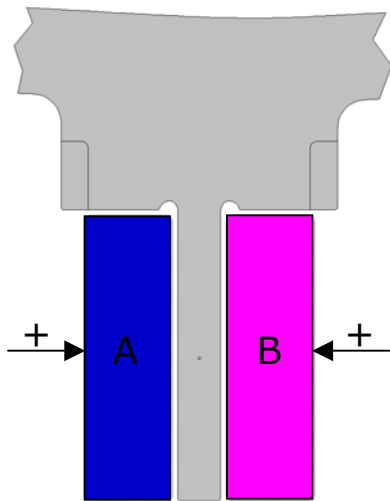
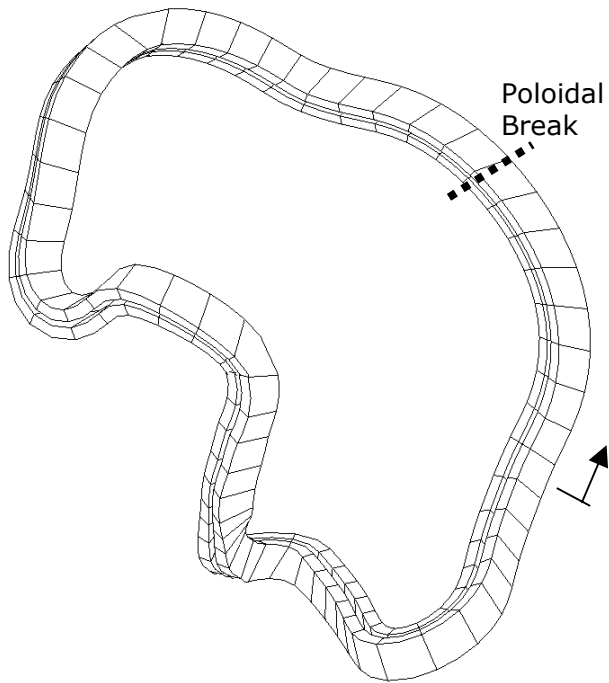

23 Jan

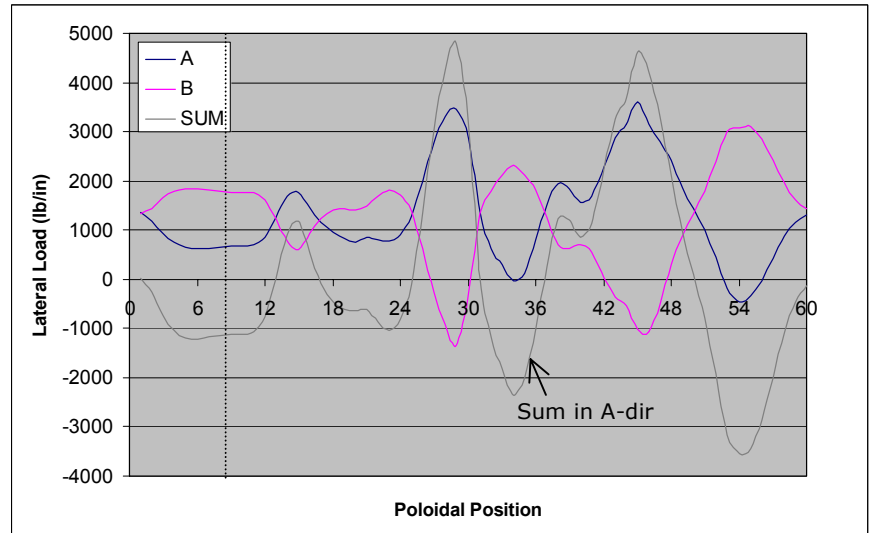

Case: PDR coilset, modular coils only, 1.7-T

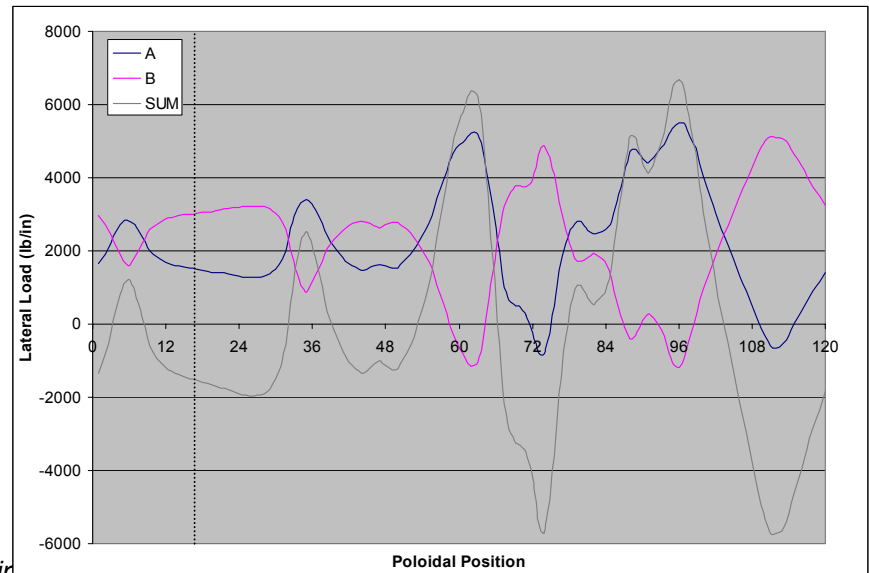

Case: CDR coilset, all coils, 2-T

Lateral EM Load, Coil M3

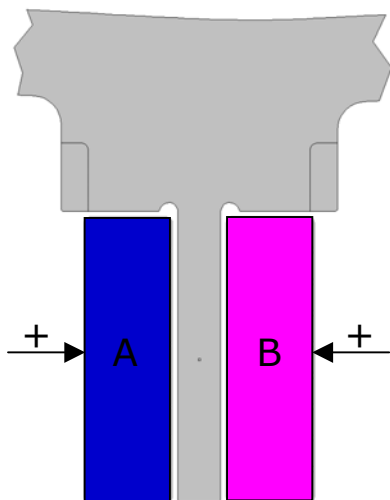
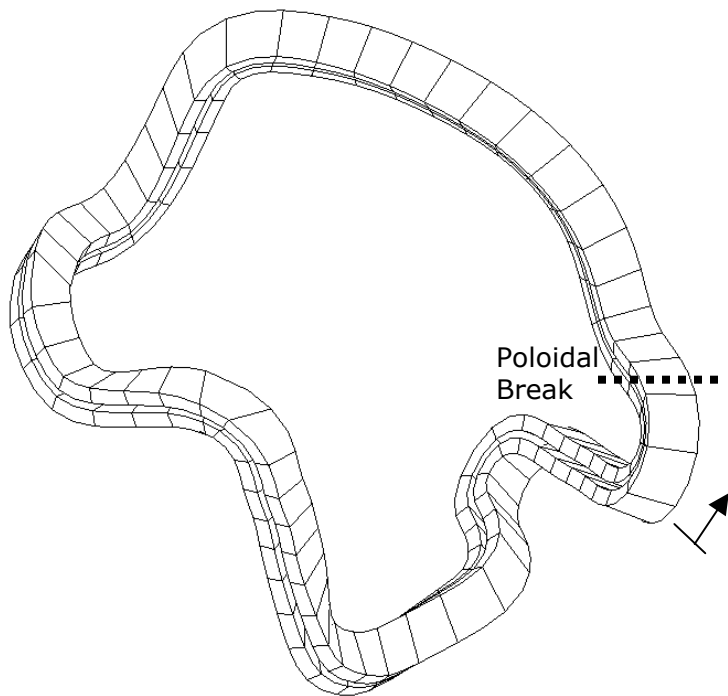

23 Jan

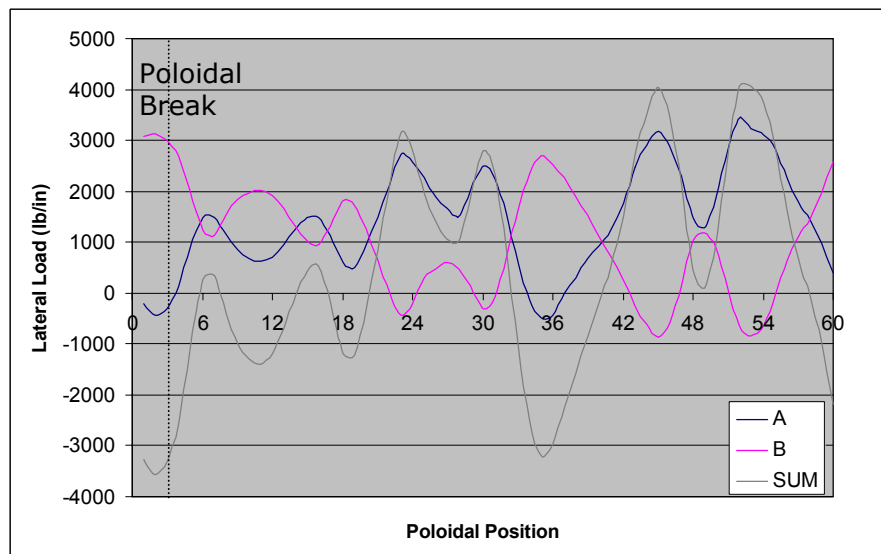

Case: PDR coilset, modular coils only, 1.7-T

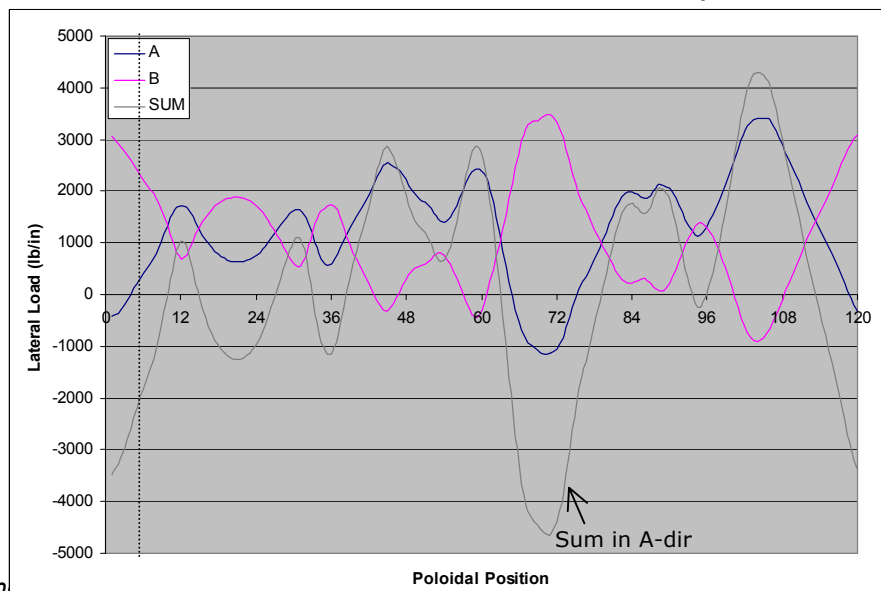

Case: CDR coilset, all coils, 2-T

NCSX Win...

Poloidal break – issues

- **Distortion of casting when break is machined**
- **Damage to insulator from cutting fluids, cleaning, etc.**
- **Difficult to inspect break since both sides are at the same potential**
- **Discontinuity in winding support causes excessive local deformations and/or fault in insulation**
- **Bolts get loose over time, tee-to-tee connection not accessible**
- **Costs more to include break than to not include break**

Poloidal break – cost impact ROM est.

- Design – Extra part models, drawings (3 mm) \$50k
- Analysis – Complicated analysis of “Tee” connection \$50k
- Fabrication of Winding form \$400k
 - Special tooling/fixtures (\$40k total)
 - Machining of casting (\$13k/coil)
 - Extra parts (\$5k/coil)
 - Assembly, inspection (\$2k/coil)
- Winding and VPI operations \$36k
 - Additional work around “tee” connection, (\$2k/coil)
- Assembly inspection \$4k
- Total estimated cost \$540k

Poloidal break – recommendation

Since:

- 1. We can't easily calculate the EM effects of not having the break, and this could affect operation significantly, and*
- 2. We won't be able to add the break if later analysis says we have to have it, and*
- 3. We need to get on with the design and R&D, so:*

Therefore: **Keep the breaks**

- 1. Refine the tee-to-tee connection, in conjunction with machining advice from vendors and a desire to avoid inaccessible bolts**
- 2. Analyze the lateral loads and local stresses and deformations.**
- 3. Modify the models and drawings as needed**

Thermal conducting layer

- **Modular coil winding cooled by conduction to copper layer on winding form**
- **Copper layer is insulated from winding form electrically and is divided into ~ 2 inch lengths to minimize eddy currents**
- **Copper layer is connected thermally to trace-cooled clamp**
- **Analysis indicates this approach works, with cool-down time between shots of about 15 minutes**

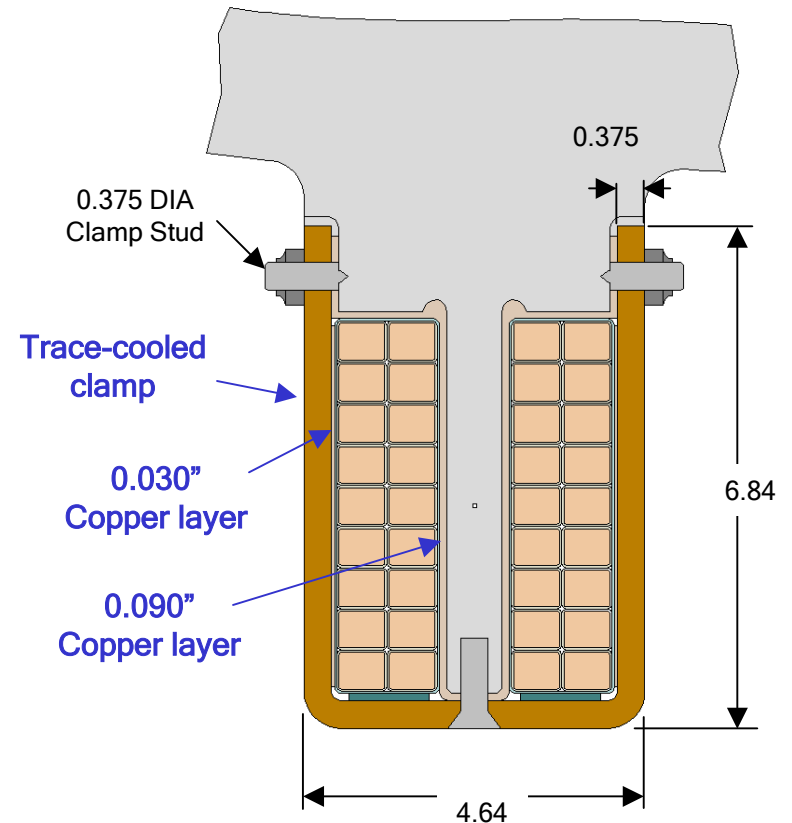

Baseline cooling concept: Cu on tee plus cooled clamps

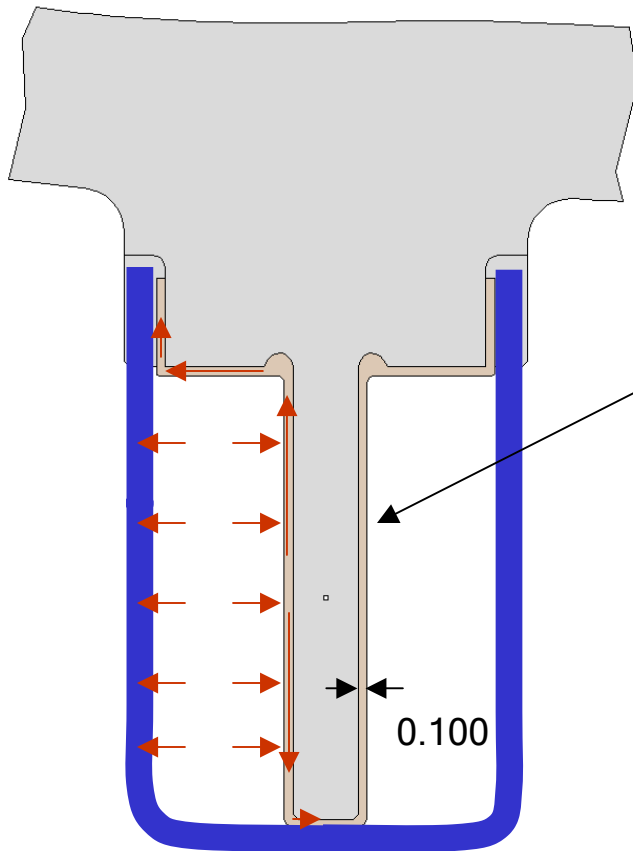

Thermal Conduction Layer Options:

- 1) Varnish SS, electroform with copper
- 2) Flame spray ceramic/copper, full thickness
- 3) Flame spray 0.010", then electroform
- 4) Copper strips, developed shapes

Alternate concept should be easier for Cu strip geometry, but requires deeper groove for tube, clamp still cooled

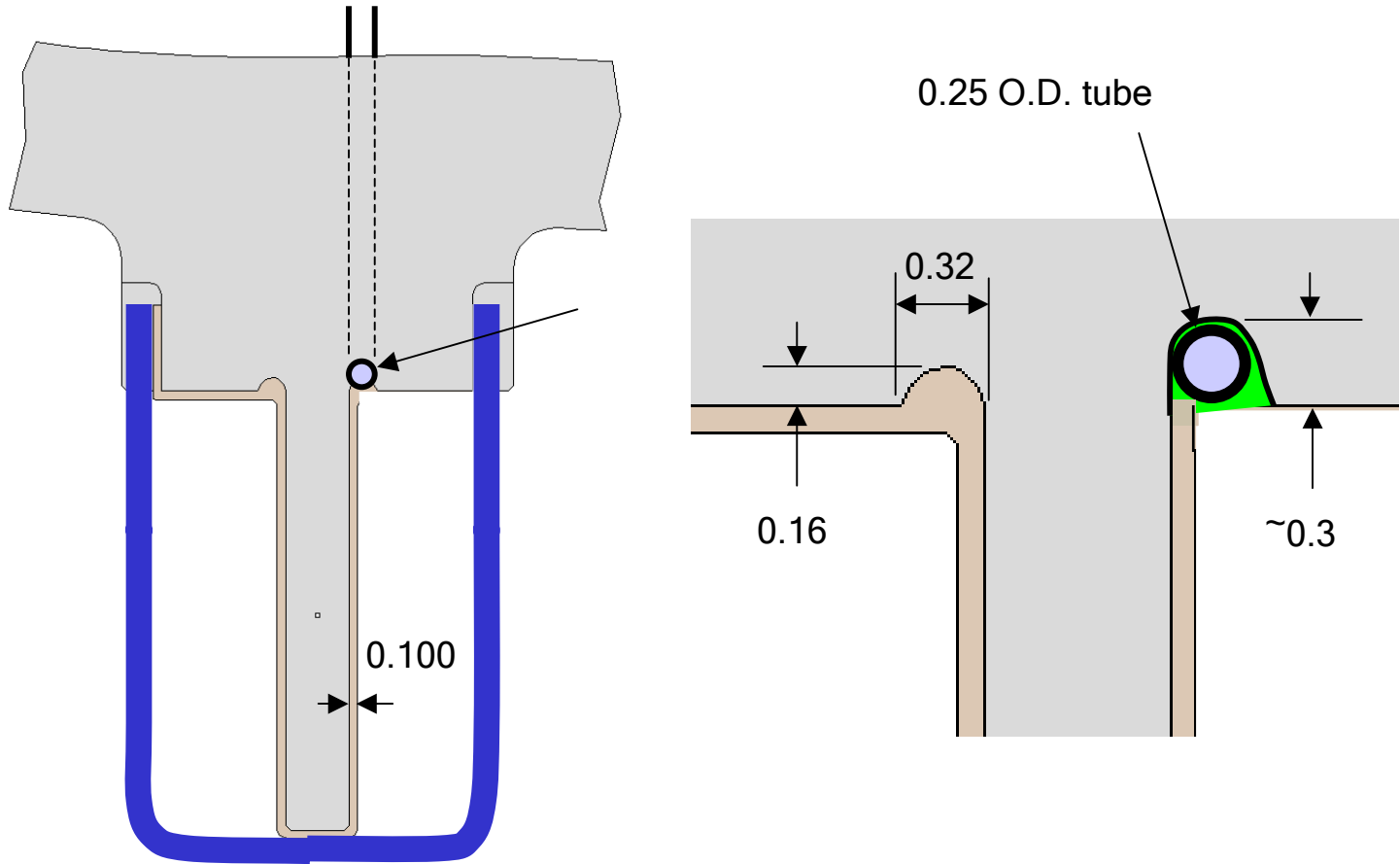

Alternate concept 2 moves tube away from corner for easier groove machining, clamp not actively cooled

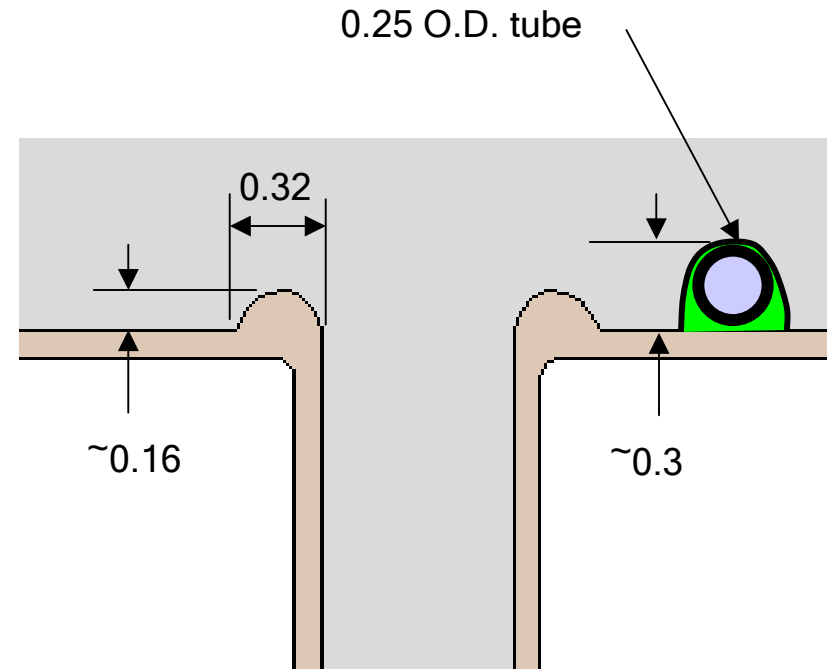
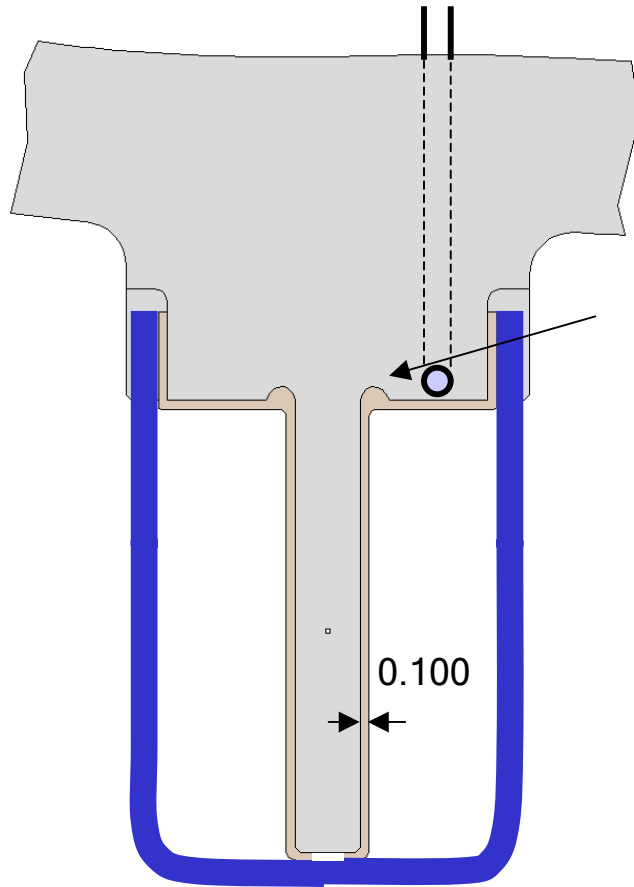

Issues with Cu cladding options:

- **Flame spray**
 - Requires ceramic substrate for electrical insulation
 - Must be machined after spray or applied with robot
 - Surface must be hand worked for decent finish
 - Thermal conductivity may not be very good
 - Difficult to do in-house
- **Electro-form (plating)**
 - Must be shipped to specialized vendor, who has equipment
 - Slow, about 1 mil per hour max
 - Must be machined, possibly twice, to retain surface tolerance
 - Probably not compatible with insulating break due to immersion in copper sulphate solution
- **Mechanical bonding of copper strips**
 - Very difficult to achieve proper shape if formed from single sheet
 - Narrow, simple shapes leave large gaps between pieces
 - Bonding process not defined yet
 - ***But, we can do it in house!***

Cu Cladding Recommendation:

- 1. Remove copper cladding from winding form task**

- 2. Apply copper strips at PPPL prior to winding**
 - Write software to make developed-shape patterns
 - Cut patterns with water jet cutter from dxf files
 - Stack of 3 or 4 0.02 inch sheets should make forming easier
 - Bonding can be done with hot melt adhesive
 - Inspection via Faro arm and ohm meter
 - Re-work accommodated by hot melt adhesive
 - Process can be tried very soon on partial full scale “tee” castings recently procured by PPPL (due end of Jan)

- 3. Internal R&D Program will be conducted over next three months to develop process**

Modular coil winding tolerances

- Stellarator coils must be very accurate to produce flux surfaces of sufficient quality
- Errors in winding geometry can produce islands, which “short circuit confinement” [A. Reiman, NCSX CDR]

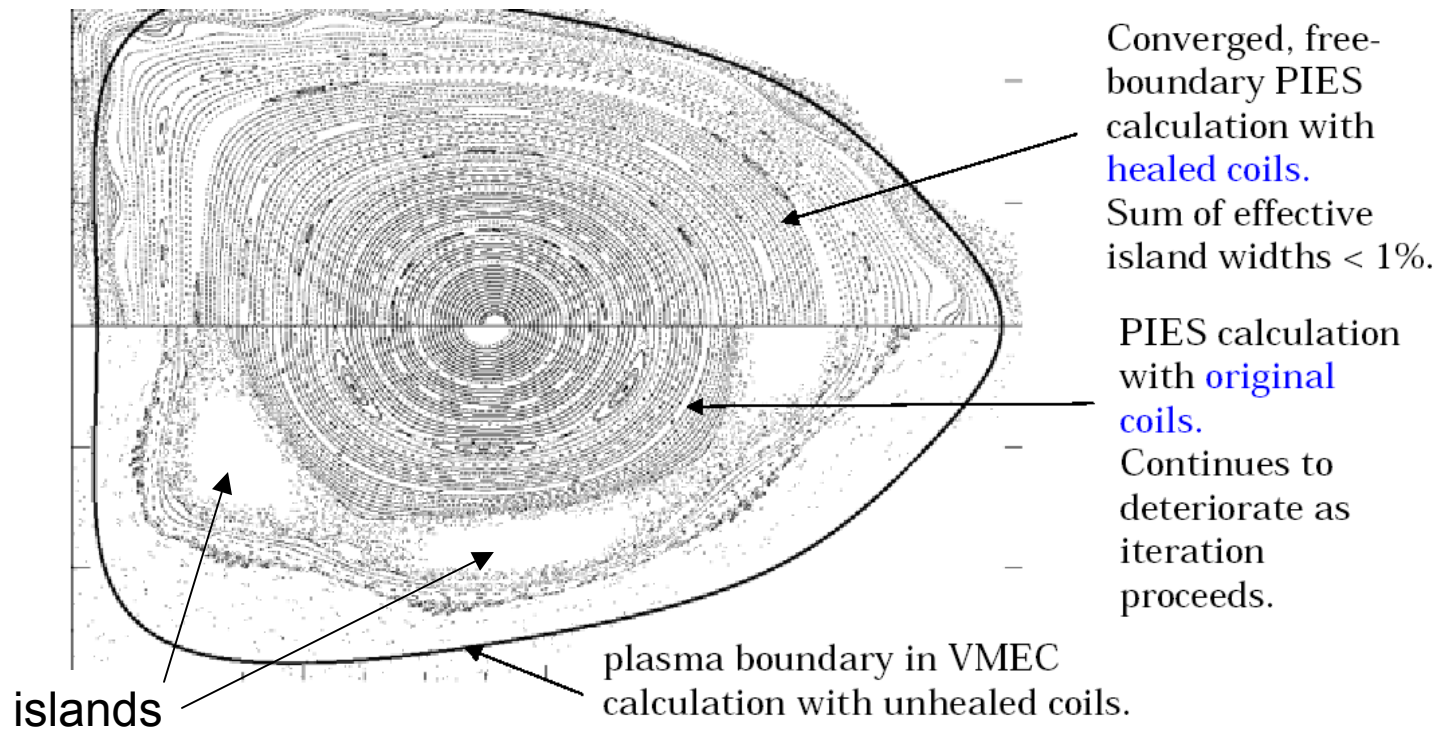

Winding accuracy requirement:

- “The toroidal flux in island regions due to fabrication errors, magnetic materials, or eddy currents shall not exceed **10%** of the total toroidal flux in the plasma.” [ref. GRD, Rev. F]
- Assumed accuracy requirement: Installed coil winding center **within 1.5 mm of theoretical** (3 mm T.P.)
- Effect of variations and combinations of winding errors studied systematically by A. Brooks
 - Modular coil distortions and position errors
 - PF coil errors
 - TF coil errors

Winding accuracy study – [ref Art Brooks]

- **Impact of Random Tolerance Stack up for Different Tolerances in Modular, TF and PF**
 - Using Fourier Representation (alla CDR)
 - Local Tolerance varies with Coil-to-Plasma Separation

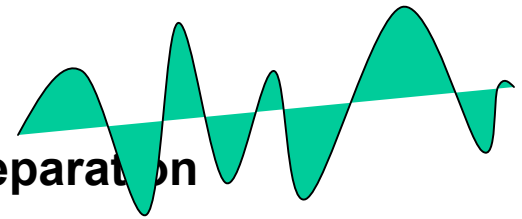

- **Impact of short “wavelet” type deformation on Modular Coils**

- Island Size vs Coil-to-Plasma Separation
- In-Plane and Out-of-Plane Deformations
- Modular Coils 1,2 &3 Considered Individually

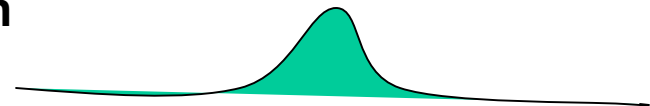

- **Impact of broad deformations of Modular Coils**
 - Island Size vs Closest Coil-to-Plasma Separation
 - Out-of-Plane Deformations of Modular Coil 1 Only



Winding accuracy study – [ref Art Brooks]

Island Size vs Coil-to-Plasma Separation
for 1.5 mm by 0.5 m out-of-plane distortion on M45 Modular Coil 1

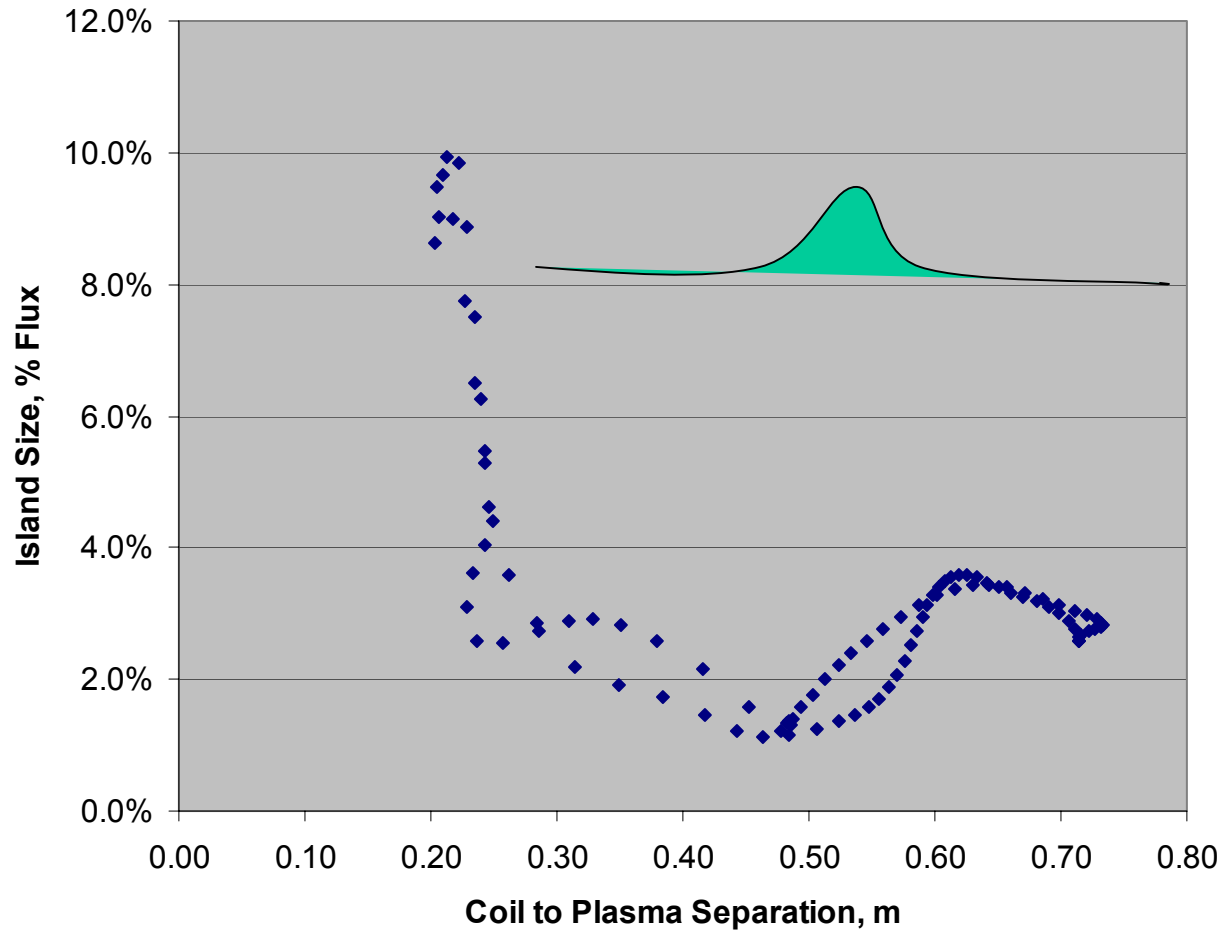

◆ %Flux, Total

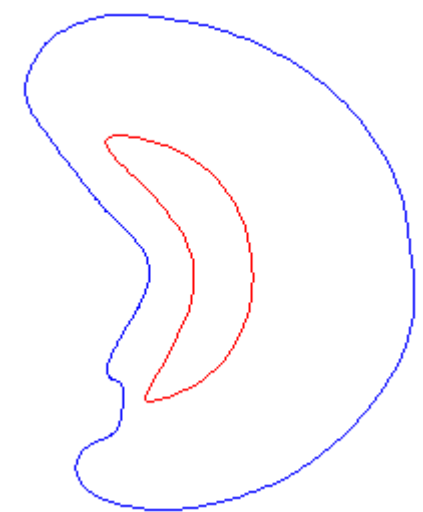

Winding accuracy study – [ref Art Brooks]

- **Impact of Random Tolerance Stack up for Different Tolerances in Modular, TF and PF**
 - Softening Tolerance on TF & PF from 1.5 to 3.0 mm appears acceptable
 - Softening **Overall** Tolerance on Modulars **not acceptable**.
 - Softening Modular Tolerance based on plasma separation (1.5mm near plasma to 3.0 far from plasma) has minimal impact
- **Impact of short “wavelet” type deformation on Modular Coils**
 - Coil-to-Plasma Separation less than 30 cm has strongest impact on island size
 - In-plane and Out-of-Plane deformations do not differ significantly
- **Impact of broad deformations of Modular Coils**
 - Increasing Length of deformation does not Increase Max Island Size

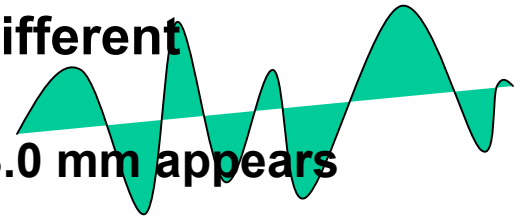

Winding form tolerance budget

- Tolerances must be divided among various elements and operations:

Element	Tolerance budget	Comment
Winding form	+/- 0.01 in.	Baseline on drawing
Copper cladding	TBD	Could be used to improve winding form tolerance if shims are allowed
Insulated conductor size	+/- 0.01 in.	Based on NEEWC input
VPI process	TBD	Assumed to be small, but not known
Assembly of coil in field period	TBD	Adjusted to best fit, coil-to-coil with custom shims
Assembly of field periods	TBD	Adjusted to best fit with custom shims
Total tolerance	+/- 0.06 in. (+/- 1.5 mm)	Minimum value, may be relaxed according to location around winding

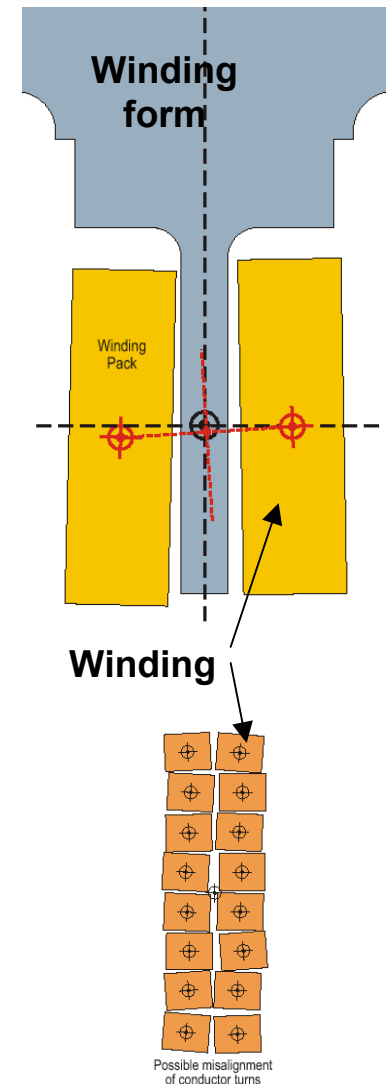

Tolerance Recommendations

- **Divide tolerance equally between**
 - **winding form / copper conduction layer**
 - **Conductor winding packs / VPI, and**
 - **Assembly**
- **Winding form and Cu would thus have a total of +/-0.02 inches from theoretical profile, or 0.04 inch bilateral profile tolerance relative to component coordinate system**
- **Leave prototype drawing tolerance as-is pending further discussions with vendors**

Options for tolerance recovery

- **Prior to winding:**
 - Custom-shim copper conduction layer to improve winding surface accuracy, including inferred current center compensation
- **During winding:**
 - Custom-shim between winding layers with additional fiberglass sheets to move winding pack center relative to winding form
- **After winding and potting**
 - Measure completed coil (maybe using CT scan – provides accurate method of measuring “as-built” winding center of each coil)
 - Develop optimized positions of “as-built” coils in assembled array
- **After assembly**
 - Measure flux surface quality
 - Use error field correction coils

Other features for winding forms

- **VPI details (sprues, groove for vacuum seal, etc.)**
- **Current feed / lead details**
- **Poloidal break details at “tee” connection**
- **Modified cooling details**
- **Measuring and handling fixture interface features**

Current feeds / crossovers

- Crossovers and “joggles” arranged for minimum field errors
- Baseline concept was to route coax leads next to winding packs
- New proposal routes leads out between winding packs,
 - *requires slightly different features on winding form*

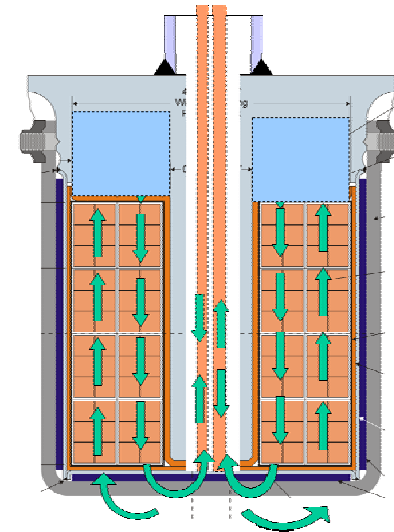
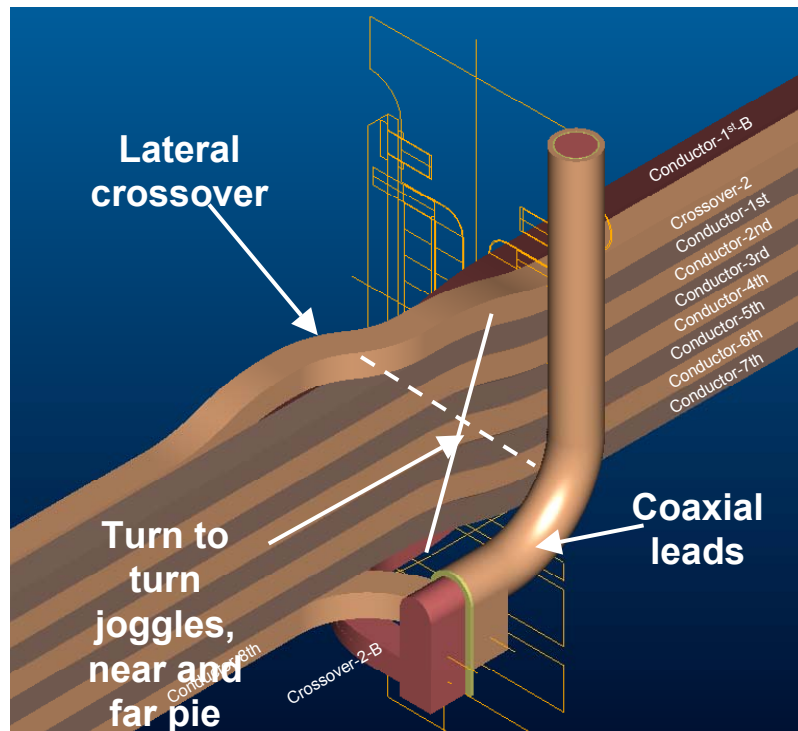

Possible lead arrangement showing opposite dipoles from crossovers

“Potting” details

- Sprues may be needed for introducing epoxy into winding
 - Bore of coil
 - Outside of coil (preferred option)
- Grooves for aiding vacuum seal are also desired

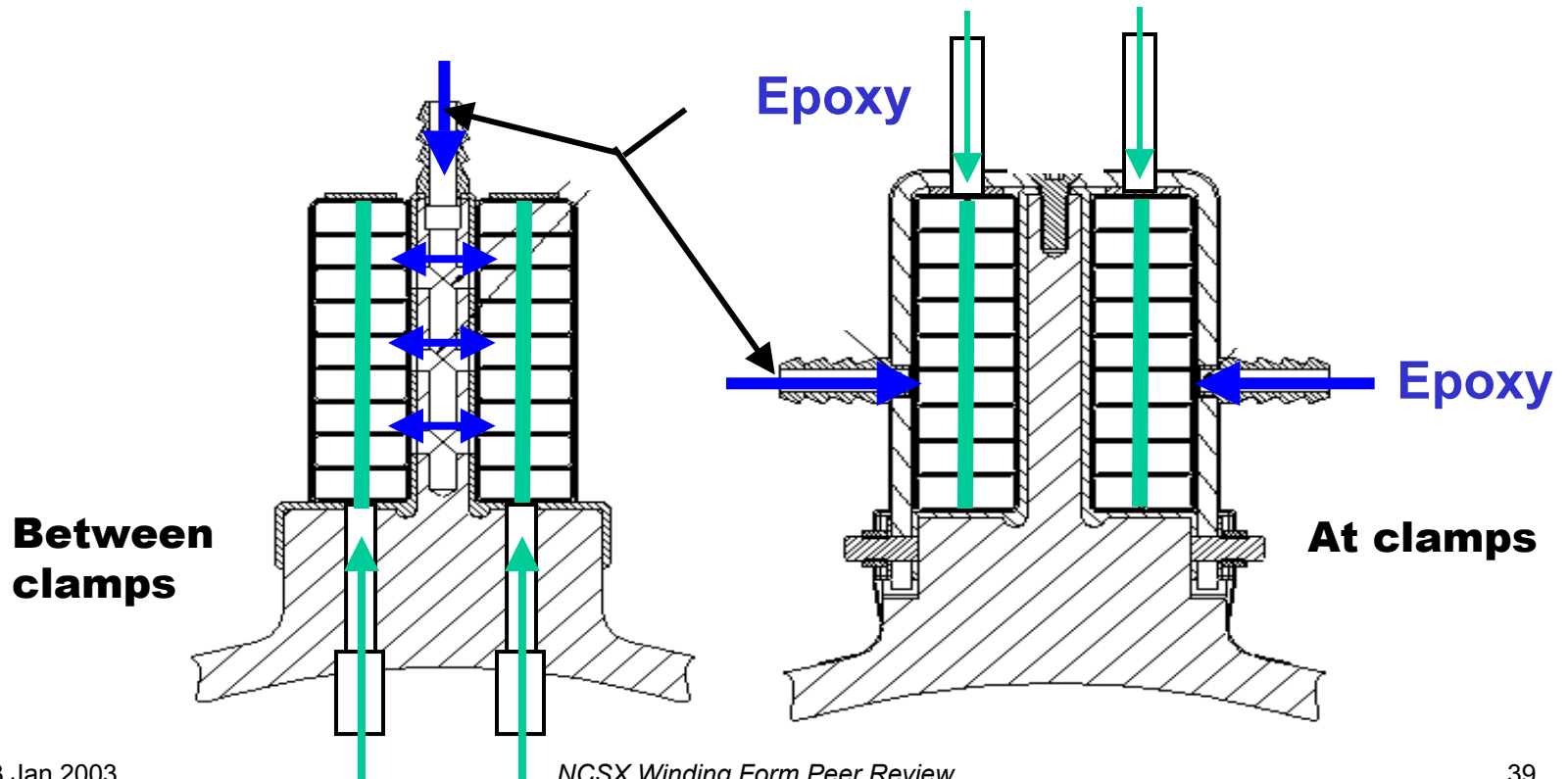

Summary

- **Poloidal break appears feasible, but “tee” connection details are not finalized**
- **Copper conduction layer to be installed at PPPL in the form of copper strips**
- **0.020 inches of total tolerance budgeted for winding form (0.010) plus copper conduction layer**
- **Other features need to be added to coil forms**