

NCSX

NCSX Manufacturing Facility Operations Plan

NCSX-PLAN-MFOP-01

January 20, 2006

Author: _____
James H. Chrzanowski- Coil Facility Manager

Co-Author: _____
Michael Viola- Field Period Assembly Facility Manager

Reviewed By: _____
Steve Raftopoulos- Field Supervisor

Reviewed By: _____
Tom Meighan- Field Supervisor

Reviewed By: _____
Mike Kalish- Field Supervisor

Reviewed By: _____
John Edwards- Field Supervisor

Reviewed By: _____
Judy Malsbury- NCSX QA Representative

Reviewed By: _____
Brent Stratton- Dimensional Control Coordinator

Reviewed By: _____
Jerry Levine- PPPL Safety Representative

Reviewed By: _____
Bill Slavin- PPPL IH Representative

Approved By: _____
Larry Dudek- RLM for Manufacturing Facility

**NCSX Manufacturing Facility Operations Plan
NCSX-PLAN-MFOP-01**

RECORD OF CHANGE

Revision	Date	Description of Change
00	5/19/05	Supersedes NCSX-PLAN-MCFOP-01 [includes the TF coils]
01	1/20/06	Supersedes NCSX-PLAN-MFOP-01 Includes the FPA and reformatted in its entirety.

TABLE OF CONTENTS

1	Introduction and Scope	- 1 -
1.1	Introduction	- 1 -
1.2	Purpose	- 1 -
2	Applicable Documents	- 1 -
2.1	ES&H Documents	- 1 -
2.2	NCSX Project Documents	- 1 -
2.3	Permits	- 2 -
2.3.1	D-site work permits:	- 2 -
2.3.2	Confined space permits:	- 2 -
2.3.3	Flame/Fire Permit:	- 2 -
3	General Description NCSX Coils, Vacuum Vessel Subassembly (VVSA) and Field Period Assembly (FPA)	- 2 -
3.1	Modular Coils	- 2 -
3.2	Twisted Racetrack Coil	- 4 -
3.3	Toroidal Field Coil	- 4 -
3.4	Vacuum Vessel Subassembly (VVSA)	- 5 -
3.5	Field Period Assembly (FPA)	- 6 -
4	Facilities and Work Stations	- 8 -
4.1	General Facilities Description	- 9 -
4.1.1	Crane Capacity	- 9 -
4.1.2	Climate Control	- 9 -
4.1.3	Work Space	- 9 -
4.2	Work Station Descriptions	- 9 -
4.2.1	Coil Fabrication	- 9 -
4.2.2	Field Period Assembly	- 11 -
5	Manufacturing Inspection & Test/Quality Assurance Plans	- 11 -
6	Flow Plan of the Manufacturing Operations	- 12 -
6.1	Twisted Race Track Coil (TRC)	- 12 -
6.2	Modular Coils	- 13 -
6.3	Toroidal Field Coils	- 14 -
6.4	Field Period Assembly	- 15 -
7	Organization and Operating Guidelines	- 16 -
7.1	Organization	- 16 -
7.1.1	Responsible Line Manager (RLM)	- 16 -

NCSX Manufacturing Facility Operations Plan
NCSX-PLAN-MFOP-01

7.1.2	Manufacturing Facility Manager	16 -
7.1.3	Field Supervisors	16 -
7.1.4	Lift Engineer	16 -
7.1.5	Coil Test Director	17 -
7.1.6	Lead Technicians	17 -
7.1.7	Field Crews	17 -
7.1.8	Health Physics Representative	17 -
7.1.9	Industrial Hygiene Representative	17 -
7.1.10	Dimensional Control/Metrology Representative(s)	17 -
7.1.11	Construction Safety Representative	17 -
7.1.12	Quality Control Representative	18 -
7.2	General Facility Operating Guidelines	19 -
7.3	Guidelines for Doing Work in the NCSX Manufacturing Facility	19 -
7.3.1	Field Supervisors	19 -
7.3.2	House-Keeping/Cleanliness Rules	19 -
7.3.3	Food, Smoking, Gum	19 -
7.3.4	Clean Environment	19 -
7.3.5	Access to Work Stations #2-4	19 -
7.3.6	Step-Off Pads	19 -
7.3.7	Special Clothing Recommendations	19 -
7.3.8	Daily Cleaning	19 -
7.3.9	Gloves	20 -
7.3.10	Markers and Pencils:	20 -
7.3.11	Chips and Filings:	20 -
7.3.12	Hard hats	20 -
7.3.13	Station Logbook	20 -
7.3.14	Daily Summary Report	21 -
8	Safety and Training Requirements	21 -
8.1	Integrated Safety Management (ISM)	21 -
8.2	Project NEPA, Hazard Analysis, & Pre-Ops Safety Certifications	21 -
8.3	Job Hazard Analysis Surveys and Safety Meetings	22 -
8.3.1	Specific Job Hazard Analyses	22 -
8.3.2	Safety Meetings	22 -
8.4	Safety Walk-Through's	22 -
8.5	Training:	23 -
8.6	Personal Protective Equipment [PPE's]	23 -
8.7	Radiation Controlled Area:	23 -
8.8	Emergency Response Procedure	23 -
9	Meetings and Communication Requirements	23 -
9.1	Daily Startup Meetings	23 -
9.2	Pre-Job Briefings	24 -
9.3	Post-Job Briefings	24 -
10	Documentation Requirements	24 -
10.1	Document Control	24 -
10.2	Field Packages	25 -
10.3	Documents Retention and Storage	25 -

NCSX Manufacturing Facility Operations Plan
NCSX-PLAN-MFOP-01

11	Quality Assurance/Quality Control Requirements.....	25 -
11.1	Quality Control during Manufacturing.....	25 -
11.2	Measurements	25 -
11.3	Other Quality Control Representative Responsibilities.....	25 -

LIST OF FIGURES

Figure 3-1	-Modular Coil Types.....	- 3 -
Figure 3-2-	Twisted Racetrack Coil.....	- 4 -
Figure 3-3-	Toroidal Field Coil.....	- 5 -
Figure 3-4-	VVSA.....	- 6 -
Figure 3-5-	Complete Stellarator Core Field Period.....	- 7 -
Figure 4-1-	NCSX Manufacturing Facility.....	- 8 -
Figure 6-1	- Flow Plan for TRC Fabrication	- 12 -
Figure 6-2	- Flow Plan for MC Fabrication -.....	- 13 -
Figure 6-4-	Flow Plan for TF Coil Fabrication.....	- 14 -
Figure 6-5-	Field Period Assembly Outline.....	- 15 -
Figure 7-1-	NCSX Coil Manufacturing Facility Organizational Chart.....	- 18 -

NCSX Manufacturing Facility Operations Plan
NCSX-PLAN-MFOP-01

1 Introduction and Scope

1.1 Introduction

The National Compact Stellerator Experiment (NCSX) Modular and Toroidal Field Coils will be manufactured at the Princeton Plasma Physics Laboratory (PPPL) for the NCSX Project. This document describes the general operating plan that will be used during the manufacturing of the Twisted Racetrack (TRC), Modular Coils (MC) and Toroidal Field (TF) coils and field period assembly (FPA) which includes five separate assembly stations.

This plan supersedes the Coil Manufacturing Facility Operations Plan [NCSX-PLAN-CMFOP-01-00].

1.2 Purpose

The purpose of this operations plan is to describe how the activities within the NCSX Manufacturing Facility will meet PPPL Integrated Safety Management (ISM) requirements specified in laboratory policies, programs, and procedures. It will also provide an overview of the general processes that occur in the facility. More detailed descriptions and processes for each process will be described in specific Manufacturing, Inspection and Test/Qualify Assurance (MIT/QA) plans and detailed manufacturing/assembly procedures.

2 Applicable Documents

2.1 ES&H Documents

Document Number	Title
ESH-004	Job Hazard Analysis
ESH-008	Access to Radiological Areas (RCA's)
ESH-014	NEPA Review System
ES&H 5008	PPPL Environmental, Safety and Health Manual
NEPA 1283	Modular and TF Coil Development and Production
NCSX-PHA-141-01	Modular Coil Manufacturing Facility Preliminary Hazard Analysis

2.2 NCSX Project Documents

Document Number	Title
NCSX-MIT/QA-131-01-00	Mfg., Inspection, Test/QA Plan for Toroidal Field Coils
NCSX-MIT/QA-142-01-00	Mfg., Inspection, Test/QA Plan for Modular Coils
NCSX-MIT/QA-185-01-00	Mfg., Inspection, Test/QA Plan for Field Period Assembly

**NCSX Manufacturing Facility Operations Plan
NCSX-PLAN-MFOP-01**

2.3 Permits

2.3.1 D-site work permits:

D-site work permits are required whenever work is being performed at D-site. It identifies the type of work and procedures being used.

2.3.2 Confined space permits:

Confined Space permits are required whenever a person is entering a permit required confined space. It identifies any restrictions, requirements and personnel who are authorized for entry. The PPPL Industrial Hygienist (IH) representative issues the permit. [Requires a “safety watch”] (Example: Autoclave entrances when the dome is in position)

2.3.3 Flame/Fire Permit:

Flame/Fire permits are required whenever open flame activities such as welding, soldering, grinding, etc. are being performed. The permit is issued by PPPL’s Emergency Service Unit (ESU) and requires a fire watch.

3 General Description NCSX Coils, Vacuum Vessel Subassembly (VVSA) and Field Period Assembly (FPA)

3.1 Modular Coils

The Modular Coil Set consists of three field periods with 6 coils per period for a total of 18 coils. Due to symmetry, only three different coil shapes are required to make up the complete coil set. Each modular coil is constructed by winding pre-insulated rectangular compacted copper cable onto a stainless steel cast winding form. Each coil consists of two double pancake windings. Once wound, the entire coil is vacuum-pressure impregnated (VPI) with epoxy. The winding forms are bolted together to form a complete torus and are electrically insulated from each other at the bolted flange interfaces. The coil set will be pre-cooled to cryogenic temperatures before each experimental pulse by nitrogen gas. Figure 3-1 shows the (3) different modular coil types.

**NCSX Manufacturing Facility Operations Plan
NCSX-PLAN-MFOP-01**

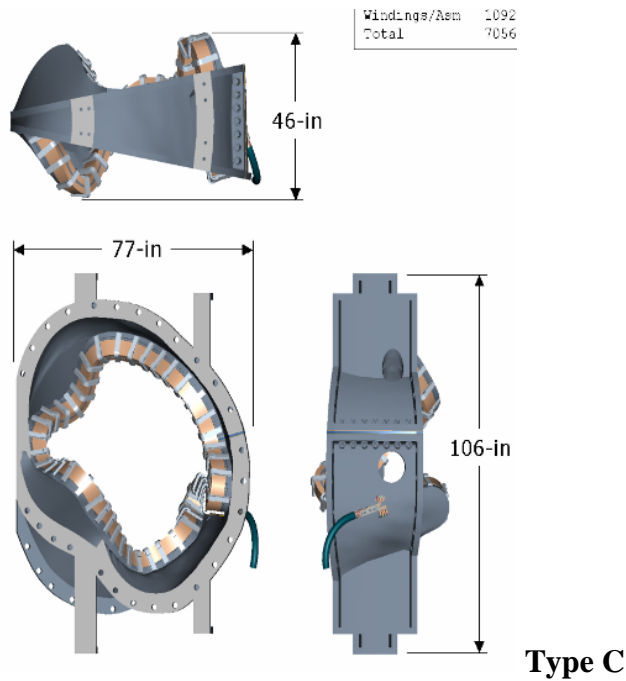
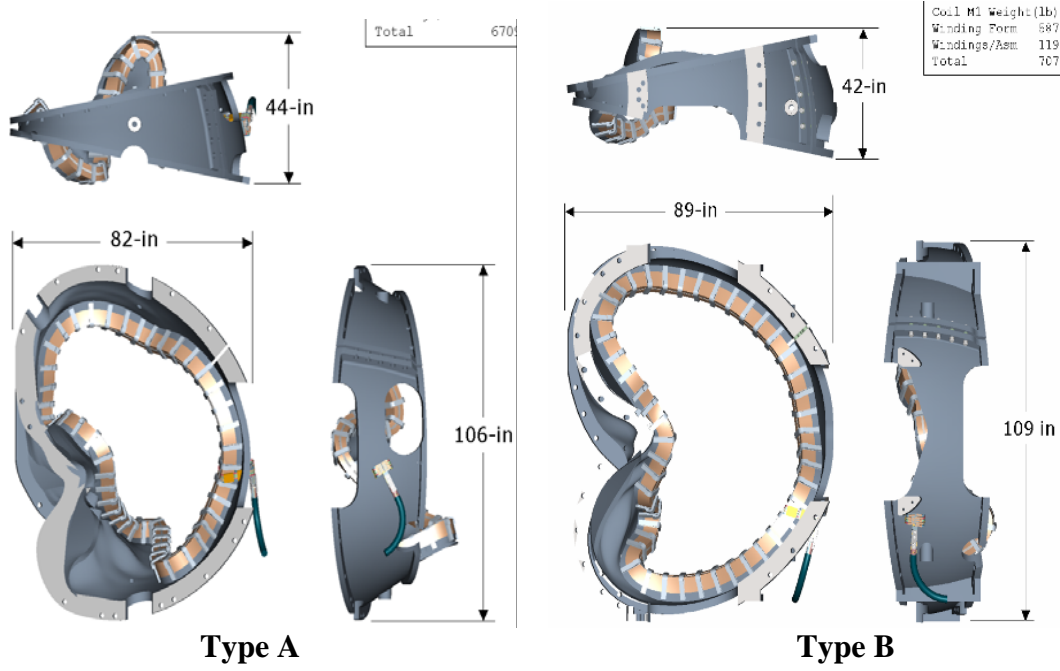

Figure 3-1 -Modular Coil Types

3.2 Twisted Racetrack Coil

The Twisted Racetrack coil (TRC) was designed to replicate many of the design features that are in the modular coils. It includes the same cross-section; general construction (insulation, conductor, epoxy system); lead design; cooling system and typical complex geometry. This coil will be used to verify the design elements, manufacturing procedures, qualify tooling and equipment and train personnel. Figure 3-2 shows the Twisted Racetrack coil.

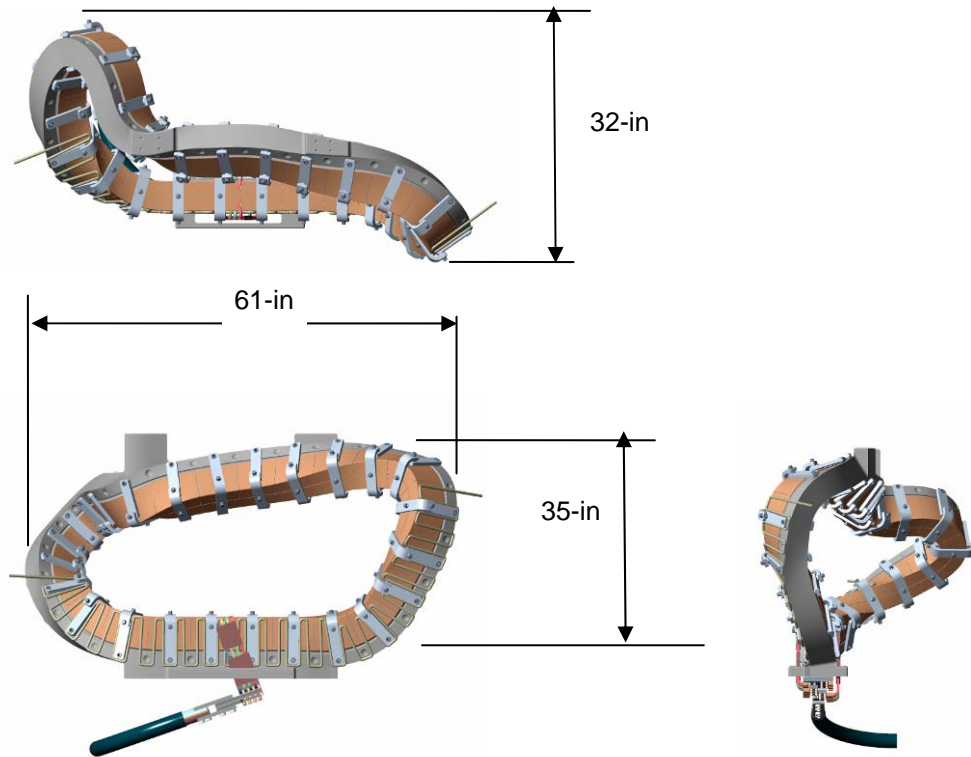

Figure 3-2- Twisted Racetrack Coil

3.3 Toroidal Field Coil

The Toroidal Field (TF) Coil Set consists of a total of 18 identical, equally spaced coils. Each TF coil has 12 turns and is constructed by winding pre-insulated rectangular hollow core copper conductors onto a winding mandrel. Once wound, the coils are ground wrapped with fiberglass tape, placed in a vacuum mold and epoxy impregnated (VPI) in the autoclave. A stainless steel nose casting will then be installed. During post VPI testing and operation, the coil set will be pre-cooled to cryogenic temperatures using nitrogen gas. Figure 3-3 shows a typical Toroidal Field Coil. [The present plan is to cold test only the first TF coil. However, the project may elect to test additional coils]

**NCSX Manufacturing Facility Operations Plan
NCSX-PLAN-MFOP-01**

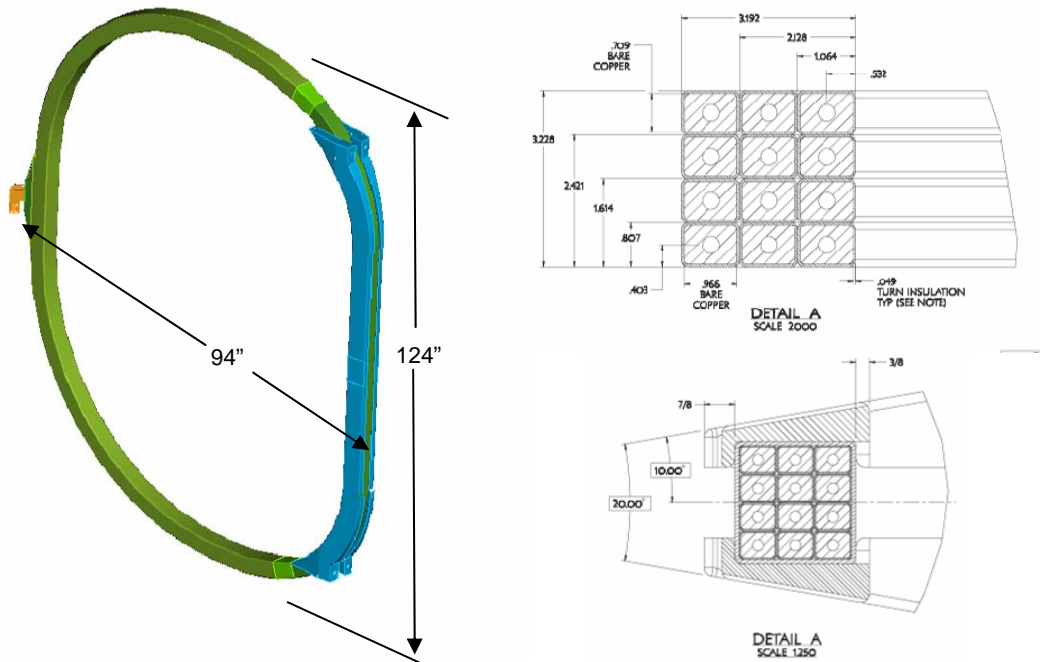

Figure 3-3- Toroidal Field Coil

3.4 Vacuum Vessel Subassembly (VVSA)

There are three VVSA's. Once received, the VVSA shall be checked for conformance to the specification and then placed into the field period assembly staging area. The VVSA, SE120-002, consists of a vessel shell referred to as a Vacuum Vessel Period Assembly (Period Assembly), SE120-003, a Spacer Assembly (Spacer), SE121-014, two (2) Vacuum Vessel Blank Off Covers, SE121-102, two (2) Vacuum Vessel Seals, SE121-095, and the port extension assemblies with their associated blank flanges, seals, and fasteners. Three VVSA units, including all hardware in the referenced drawings, are to be procured, fabricated, and delivered by the fabricator, Major Tool. Bills of material are provided in drawings listed in Appendix A. The three VVSA units will be welded together to form the vacuum vessel during final assembly at the operation site. The final assembly will be the responsibility of the Laboratory.

The subassembly fabrication sequence will entail welding the port extension assemblies onto the vessel wall and then cutting off all except the large vertical ports, the neutral beam port located mid-segment, and the Spacer port, leaving stubs which will serve as reinforcement and locating positions for subsequent reinstallation of the port extensions. The cut off port extensions will be re-welded onto the Period Assemblies after installation of the modular coils and toroidal field coils as part of the NCSX vacuum vessel final assembly operation. Reinstallation of port extensions will be the responsibility of the Laboratory. The structure will be supported from the modular coil shell structure via adjustable hangers. The VVSA coordinate system is defined in the reference engineering drawings and shown below in Figure 3-4.

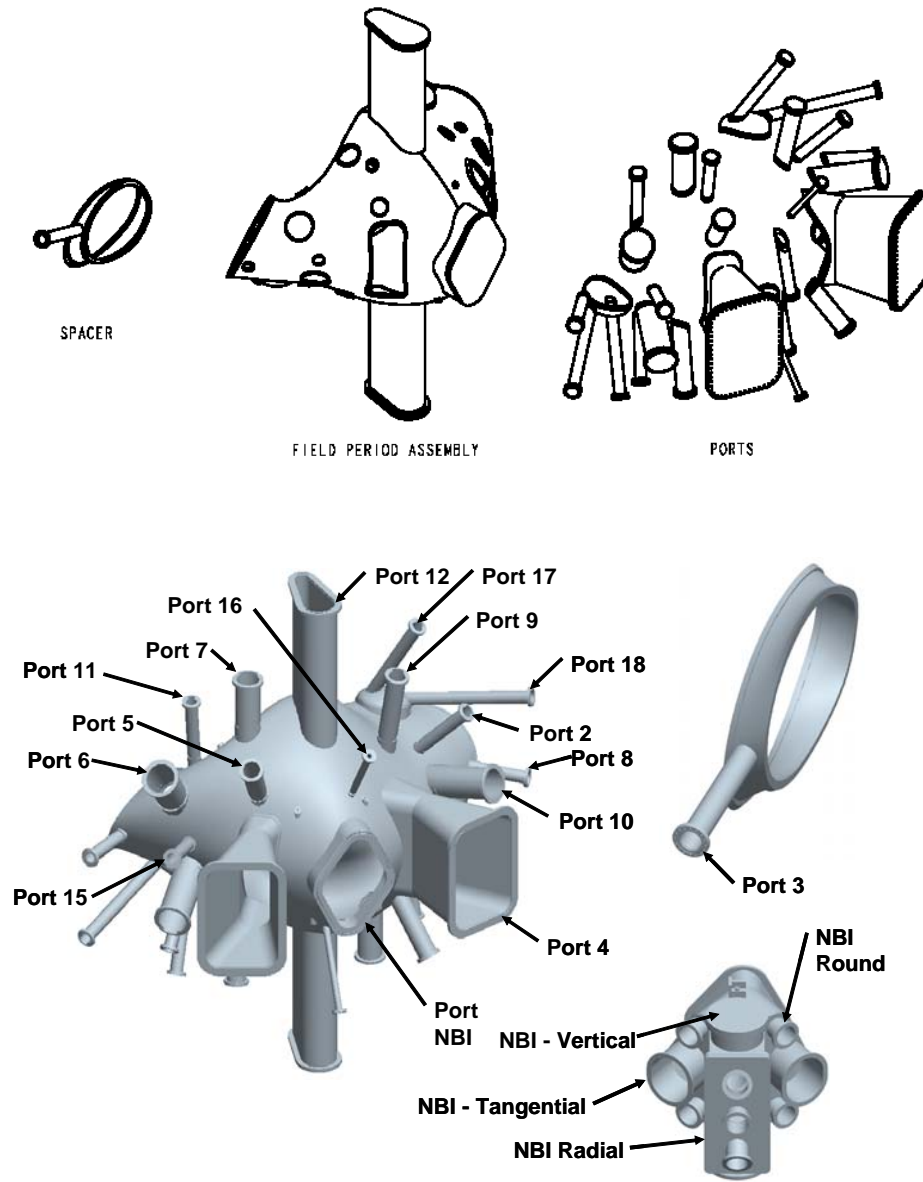

Figure 3-4- VVSA

3.5 Field Period Assembly (FPA)

The Field Period Assembly (FPA) includes all the design, tooling, equipment, materials and labor required to prepare for assembly and to assemble one field period of the stellarator core. A complete field period is illustrated in Figure 3-5. Activities include receipt and inspection of the various components, preparation for assembly, assembly, inspection, and testing. The primary components include the vacuum vessel, modular coils, TF coils, coil structure, and external trim coils.

**NCSX Manufacturing Facility Operations Plan
NCSX-PLAN-MFOP-01**

The Field Period Assembly area will make use of the crane primarily for picking up major components such as the Vacuum Vessel, Modular Coil, TF Coil and the completed Field Period Assembly. The typical weight of each FPA component is shown in Table 3-1. Within the FPA area there are individual stations which have unique fixturing, handling, assembly, risks and safety concerns. Each FPA station will have a unique procedure governing work in that area. When components arrive from the vendor they will be inspected for damage, lifted off the truck and placed in the area designated for receiving inspection. All necessary documentation will be reviewed and any additional testing will be performed. When the component has passed the receiving inspection test it will be lifted to the appropriate fixture in the assembly station.

When a Field Period Assembly is completed it will be lifted from the fixture in the assembly area and set on a truck for shipment. The Field Period Assembly will be driven a short distance on site to the NCSX test cell.

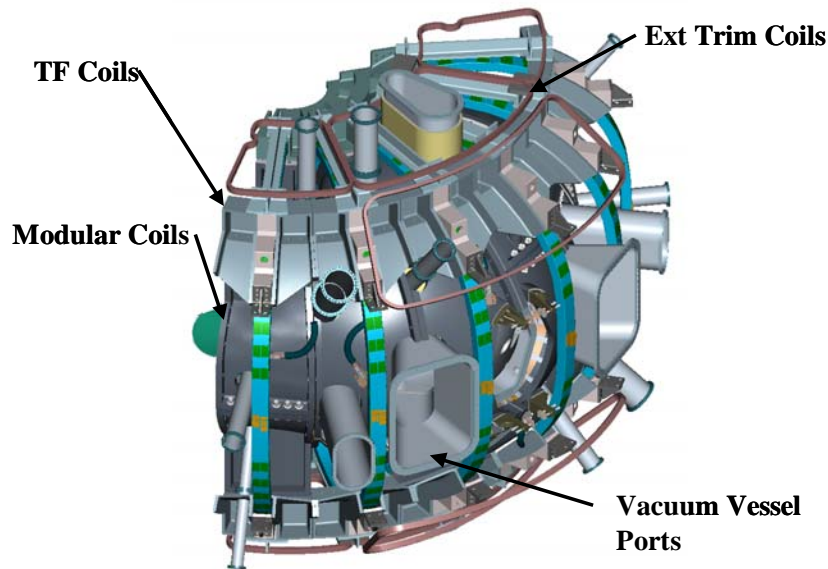

Figure 3-5-Complete Stellarator Core Field Period

Table 3-1 - Typical Weights of FPA Components

Description	Weight
Vacuum Vessel	6,400 lbs
M1 Coil [Type A]	7,100 lbs
M2 Coil [Type B]	6,700 lbs
M3 Coil [Type C]	7,100 lbs
Half period Modular Coil	21,000 lbs x 2
Half period TF Coil	11,000 lbs x 2
Field Period Assembly	70,400 lbs

NCSX Manufacturing Facility Operations Plan
NCSX-PLAN-MFOP-01

4 Facilities and Work Stations

The fabrication of the NCSX Coils and assembly of the field period assemblies will be performed in the vacated TFTR Test Cell at D-site. The NCSX Manufacturing Facility has adequate climate control needed for comfort and tolerance control and crane capabilities. There are a total of six [station 2 and 4 are duplicative] individual workstations and the Coil Test Facility (CTF) associated with the manufacturing of the MC, TRC and TF coils [labeled 1 thru 6 and the CTF], and [5] workstations associated with the assembly of the FPA [labeled V1– V5]. Figure 4-1-NCSX Manufacturing Facility below shows the layout of the NCSX Manufacturing Facility (six stations associated with coil manufacturing and five stations associated with field period assembly). The CTF as well as the coil storage area is located in the TFTR Test Cell basement. Activities performed in the CTF are not part of this operations plan.

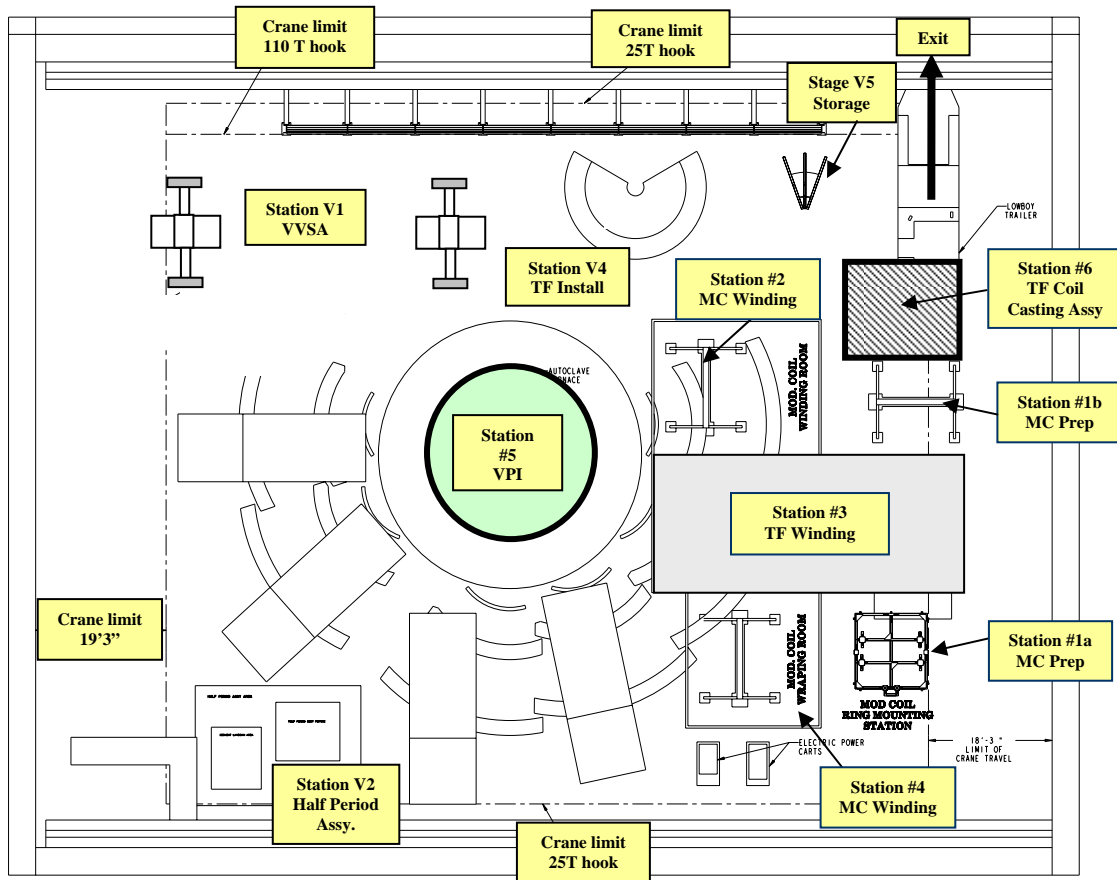

Figure 4-1-NCSX Manufacturing Facility

NCSX Manufacturing Facility Operations Plan
NCSX-PLAN-MFOP-01

4.1 General Facilities Description

4.1.1 Crane Capacity

The manufacturing facility has an overhead trolley crane with (2) hooks that will be shared between the coil fabrication and the field period assembly activities.
Load capacity: Large hook- 110 Ton; Small hook/ 25 Ton

4.1.2 Climate Control

The coil manufacturing facility environment will be maintained at a constant 70 degrees F +/- 5 degrees with 50% relative humidity +/- 10%

4.1.3 Work Space

Test Cell has over 14,000 square feet of floor space that will be shared between the coil manufacturing facility, field period assembly activities plus the remaining neutral beams from TFTR. The coil winding facility will need a minimum of 3500 square feet of floor space. The coil manufacturing area will be primarily located on the center and east side of the manufacturing facility, while the field period assembly activities will be concentrated on the north and south sides.

4.2 Work Station Descriptions

4.2.1 Coil Fabrication

Modular Coils: There are a total of [4] workstations associated with the production of the Modular Coils. Stations 1, 2, 4 and 5 are located in the Coil Manufacturing Facility (CMF). The Coil Test Facility “CTF” is located in the basement.

Twisted Racetrack Coils: There are a total of [2] workstations associated with the production of the TRC. Stations 2 and 5 are located in the Coil Manufacturing Facility (CMF). The CTF is located in the basement.

Toroidal Field Coils: There are [3] workstations associated with the production of the TF coils. Stations 3, 5 and 6 are located in the Coil Manufacturing Facility (CMF). The CFT is located in the basement.

4.2.1.1 Station No. 1a & b- Winding Form Preparation and Post VPI

Modular Coils: [Winding Form Prep]: At this Station 1a the modular coil winding forms are mounted to the turning fixture support rings. The assembled MC form and support ring are then installed into the Station 1b turning fixture. There the winding forms are inspected and cleaned. The poloidal break will be electrically tested and sealed, the coil clamp studs are welded in position, initial metrology and inspections performed and the inner copper cladding is installed.

[Post VPI]: Once the coil has been epoxy impregnated (VPI) at station 5 (Autoclave/VPI), it will return to station 1b for cleanup, installation of final coil clamps and final room temperature electrical testing.

NCSX Manufacturing Facility Operations Plan
NCSX-PLAN-MFOP-01

4.2.1.2 Stations 2 & 4- Coil Winding and Mold Preparation

Modular Coils: Stations 2 and 4 are identical to permit 2 coil winding activities to occur in parallel. At these two stations the pre-insulated copper cable conductors are wound onto the stainless steel winding forms [castings]. Work at this station includes winding, adjusting the coil centroid using the Romer (CCM), the installation of the Groundwrap insulation as well as completion [brazing] of the coil leads. Once the Groundwrap has been completed, the outer chill plates, outer diagnostics, and “Bag Mold” are installed. These (2) stations are enclosed with a ceiling and walls to better control the cleanliness of the winding environment. The rooms are provided with positive pressure that may be utilized to reduce any outside contamination.

Twisted Racetrack Coil: At Station 2 all winding form preparations as well as coil winding and post VPI activities will be performed on the TRC.

4.2.1.3 Station No. 3- Coil Winding and Mold Preparation

Toroidal Field Coils: At this station the TF coils are wound onto a winding mandrel using insulated extruded copper conductor. Work at this station includes application of turn insulation, conductor brazing, joint testing as well as completion of the coil leads. Once the coil has been wound, the coil is then moved to stands within the cleanroom, for application of the groundwrap insulation. The coil is then placed into a vacuum mold in preparation for VPI activities. This station is enclosed with a ceiling and walls to better control the cleanliness of the winding environment. The room is provided with positive pressure that may be used to reduce any outside contamination.

4.2.1.4 Station No. 5- Autoclave/VPI

This station is comprised of the autoclave [vacuum/pressure oven], epoxy mixing station and epoxy control/delivery manifold for performing the epoxy vacuum-pressure-impregnation of the TRC, MC and TF coils.

4.2.1.5 Station No. 6- TF Wedge Casting Assembly:

At this station a matching pair of stainless steel wedge castings is assembled to the TF Coil to make up the TF Coil Subassembly. This operation occurs after VPI is complete and the coil is cured therefore a clean room is not required. The wedge castings are adhered to the coil within a steel alignment fixture to precisely locate the mating surfaces of the castings with respect to the current center of the coils. Note: This will occur following any cold testing.

4.2.1.6 NCSX Coil Test Facility (CTF)

This station is located in the Test Cell basement. This facility will be used to electrically test the coils at liquid nitrogen temperatures to ensure their integrity.

NCSX Manufacturing Facility Operations Plan
NCSX-PLAN-MFOP-01

4.2.2 Field Period Assembly

There are five workstations associated with the field period assembly. These workstations are labeled V1– V5 to differentiate from the coil stations.

4.2.2.1 Station No. V1 – VVSA receipt Inspection, diagnostic loop and cooling tube installation Facility

The Field Period Assembly will begin with the assembly of the vacuum vessel. This station is comprised of two trunions that will support the VVSA in a rotisserie style. The Diagnostic loops will be installed using small tabs spot welded to the vessel surface and then the cooling tubes will be installed with studs welded to the surface and clamps applied.

4.2.2.2 Station No. V2 – Modular Coil Assembly

This station is comprised of a tilting platform that will allow the modular coils to be aligned and bolted together.

4.2.2.3 Station No. V3 – Modular Coil and Port Extension Installation

This station is comprised of a support that will hold the vacuum vessel vertical and allow the modular coils to be rotated (screwed) onto each end of the VVSA, one at a time. Then the ports will be aligned and welded on. From this point forward, the Assembly will be called the Field Period Assembly.

4.2.2.4 Station No. V4 – TF Coil and Trim Coil Installation

This station is comprised of a support for the Field Period Assembly and a large column that will be used to support the TF Coils and rotate them onto the Field Period Assembly.

4.2.2.5 Station No. V5 – Storage and Transportation Preparation

This station is space set aside for minor intermediate operations or storage both between stations and in preparation for transportation to the NCSX Test Cell.

5 Manufacturing Inspection & Test/Quality Assurance Plans

The Manufacturing Inspection & Test/Quality Assurance Plans (MIT/QA) govern all production manufacturing activities. These documents describe the steps required to successfully manufacture, inspect and test the production NCSX coils and assemble the FPA. The (MIT/QA) plans include:

- TF Coils (NCSX-MIT/QA-131-01);
- Modular Coils and TRC (NCSX-MIT/QA-142-01); and
- Field Period Assembly (NCSX-MIT/QA-183-01)

These MIT/QA Plans identify the procedures, test plans, Field Packages etc. necessary to complete the production of the NCSX coils and field period assembly (FPA).

6 Flow Plan of the Manufacturing Operations

6.1 Twisted Race Track Coil (TRC)

Figure 6-1 provides the general flow plan outlining the operation of this facility for the Twisted Racetrack Coil.

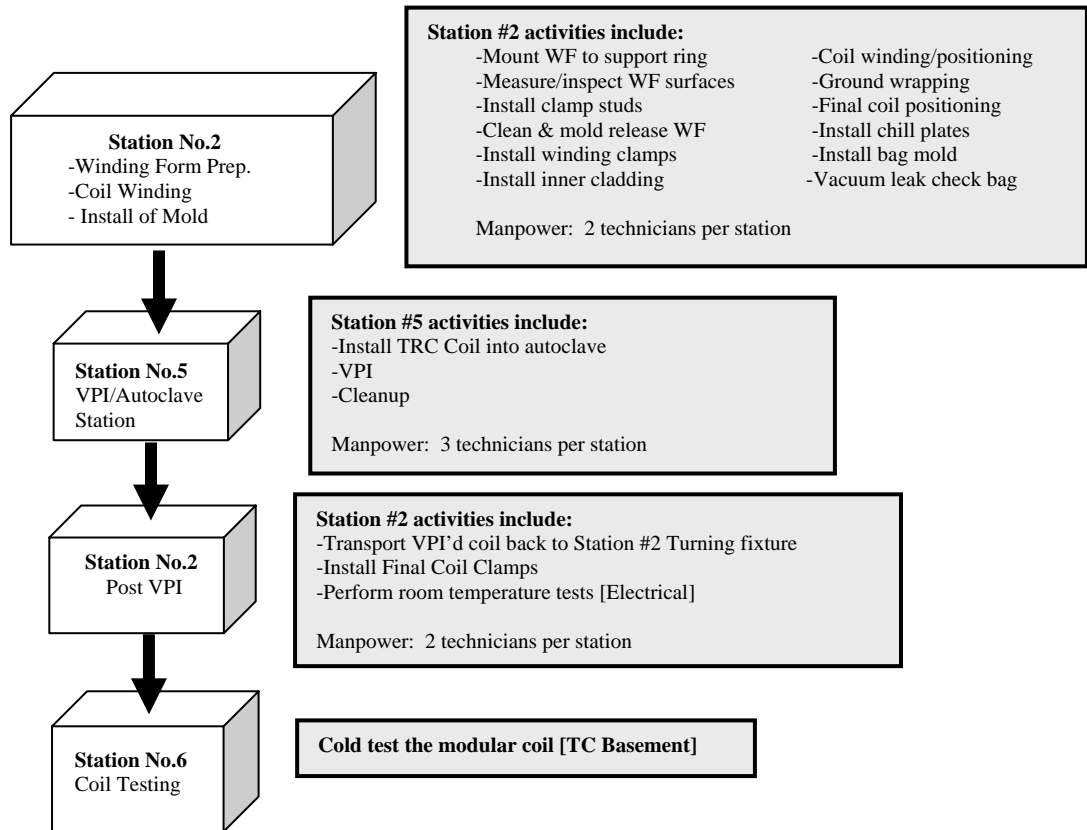

Figure 6-1 - Flow Plan for TRC Fabrication

**NCSX Manufacturing Facility Operations Plan
NCSX-PLAN-MFOP-01**

6.2 Modular Coils

Figure 6-2 provides the general flow plan outlining the operation of this facility for the Modular Coils.

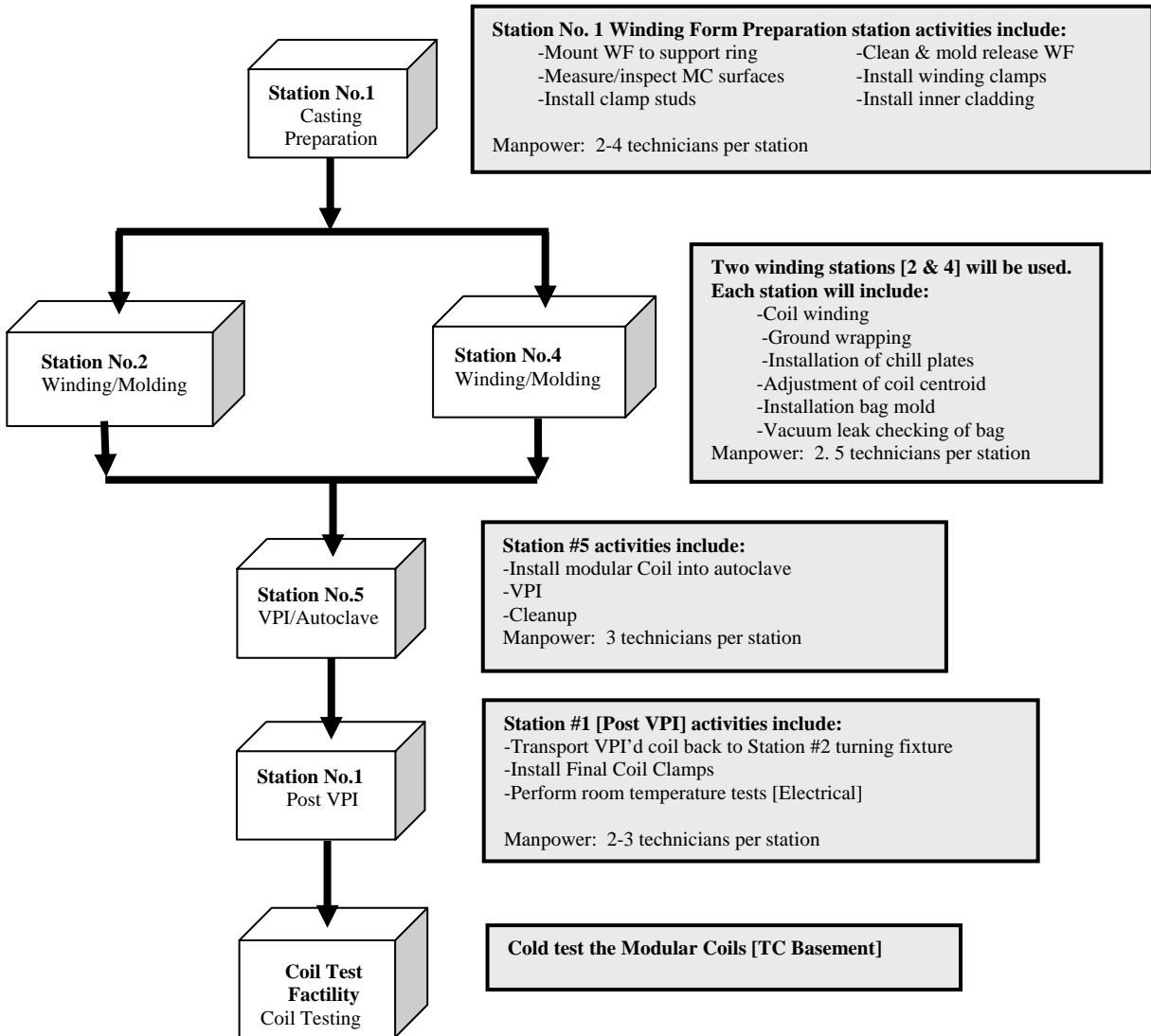

Figure 6-2 - Flow Plan for MC Fabrication -

6.3 Toroidal Field Coils

Figure 6-3 provides the general flow plan outlining the operation of this facility for the Toroidal Field Coils.

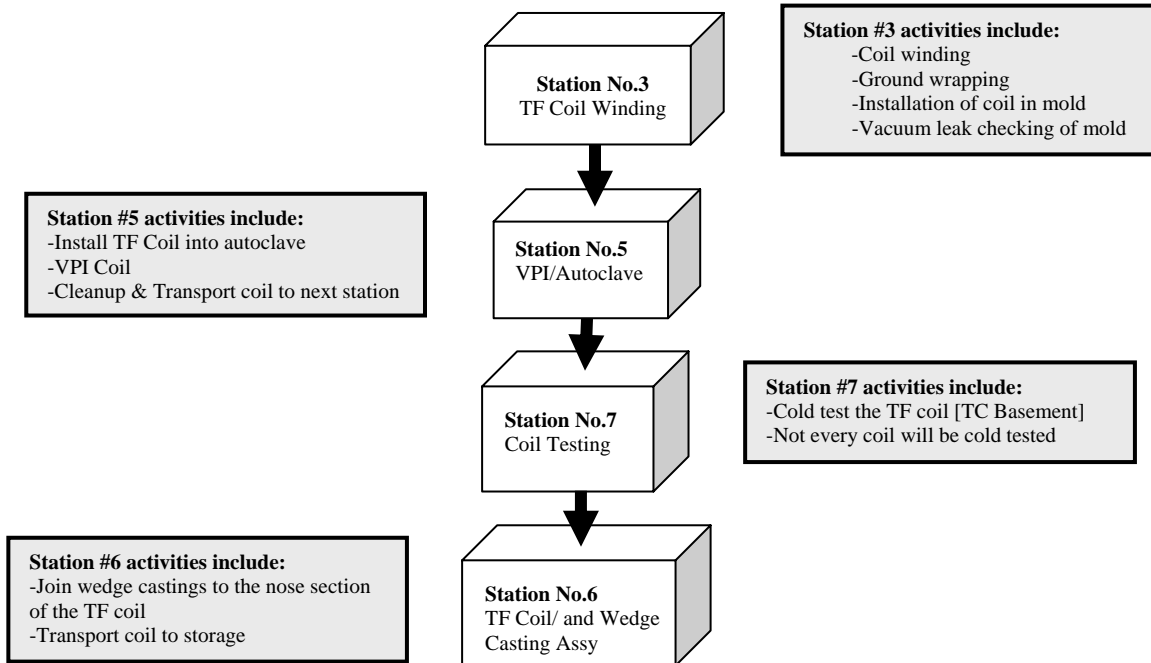

Figure 6-3- Flow Plan for TF Coil Fabrication

6.4 Field Period Assembly

Figure 6-4 provides the general outline of activities for field period assembly within the NCSX Manufacturing Facility.

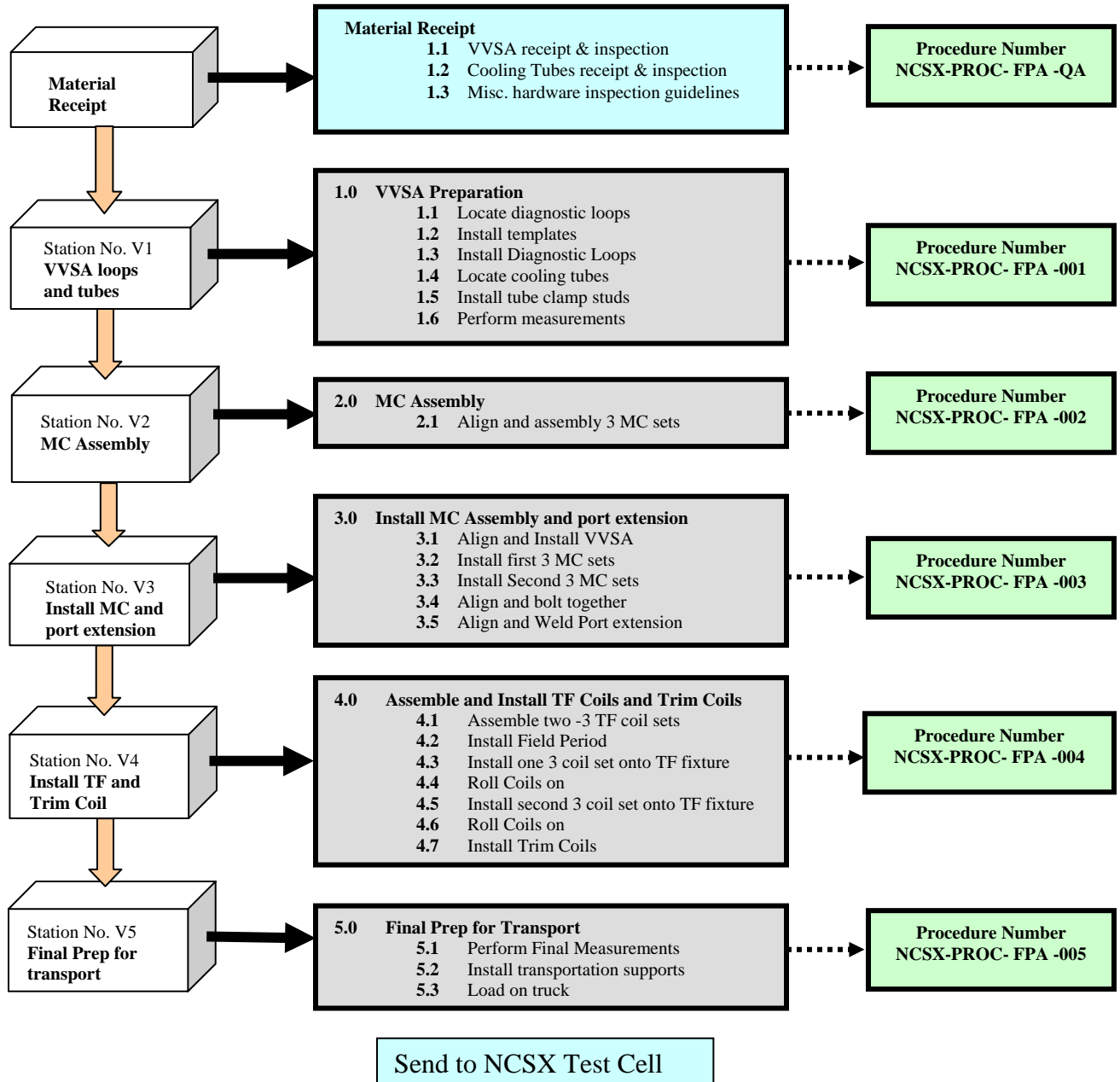

Figure 6-4- Field Period Assembly Outline

7 Organization and Operating Guidelines

This section provides the means by which activities and processes within the NCSX Manufacturing Facility will comply with PPPL's Integrated Safety Management (ISM).

7.1 Organization

This section identifies by discipline, those individuals who staff the manufacturing facility. Figure 7-1 is an overall organization chart for the Modular Coil Manufacturing Facility. The subsections, which follow, provide a brief description of each position on that organization chart.

7.1.1 Responsible Line Manager (RLM)

The Responsible Line Manager (RLM) is the designated individual who has overall responsibility for the work and the process leading to the performance of the work within the NCSX Manufacturing Facility. This individual reports to Project and PPPL Management personnel to ensure that appropriate Integrated Safety (ISM) and risk management policies, programs, and procedures are adhered to in all aspects of manufacturing/assembly activities.

7.1.2 Manufacturing Facility Manager

The Manufacturing Facility Manager is responsible for the overall operation of the NCSX Coil Manufacturing Facility and successful completion of the coils. The Field Period Assembly Manager is responsible for the overall operation of the Field Period Assembly Area and successful completion of the Stellarator Core Field Period Assembly. Duties of both Managers include managing the Field Supervisors, heading daily startup meetings and ensuring that both Integrated Safety Management (ISM) and risk management are incorporated in all aspects of the manufacturing activities.

7.1.3 Field Supervisors

The Coil Manufacturing Facility Manager is responsible for the overall operation of the NCSX Coil Manufacturing Facility and successful completion of the coils.

The Field Period Assembly Manager is responsible for the overall operation of the Field Period Assembly Area and successful completion of the Stellarator Core Field Period Assembly.

Duties of both Managers include managing the Field Supervisors, heading daily startup meetings and ensuring that both Integrated Safety Management (ISM) and risk management are incorporated in all aspects of the manufacturing/assembly activities.

7.1.4 Lift Engineer

The Lift Engineer shall monitor and retain overall responsibility for the hoisting and rigging of Critical non-repetitive lifts.

**NCSX Manufacturing Facility Operations Plan
NCSX-PLAN-MFOP-01**

7.1.5 Coil Test Director

This Coil Test Director is the engineer responsible for coordinating the testing of each coil in the Coil Test Station located in the Test Cell Basement.

7.1.6 Lead Technicians

The lead technicians are responsible for supervising the field crew activities at each workstation. They are also responsible for communicating all questions and/or concerns to the Field Supervisor filling the station log book on a daily basis and for ensuring that ISM and risk management are incorporated in all aspects of the manufacturing activities. The Lead Technician reports to the Field Supervisors.

7.1.7 Field Crews

The field crews report to the Lead Technicians and are responsible for performing the manufacturing activities as identified in the MIT/QA Plan and procedures to successfully complete the fabrication of the NCSX Coils and FPA. They are also responsible for ensuring that ISM is incorporated in all aspects of the manufacturing activities

7.1.8 Health Physics Representative

The Health Physics Representative is responsible for coordinating with the Field Supervisors all health physics issues associated with work being performed in the NCSX Manufacturing Facility (Test Cell).

[**Note:** The Manufacturing Facility is located in a Radiation Controlled Area (RCA) requiring HP coverage to ensure that activities conform to PPPL HP policy and the requirements of ESH-008.]

7.1.9 Industrial Hygiene Representative

The Industrial Hygiene (IH) Representative is responsible for reviewing and approving Job Hazard Analysis (JHA) surveys and issuing Confined Space Work Permits. He/she provides IH technical support to the field supervisors, lead technicians and field crews.

7.1.10 Dimensional Control/Metrology Representative(s)

The Dimensional Control and Metrology Representatives are responsible for defining ensuring that the centroid of the coil windings is located within the specified tolerance and critical FPA alignments are made. These individuals define, guide participate and approve of the measurements performed during coil fabrication.

7.1.11 Construction Safety Representative

The Construction Safety Representative is responsible for reviewing and ensuring that all field activities are being performed safely and in accord with PPPL safety requirements. Responsibilities include working with field supervisors, lead

NCSX Manufacturing Facility Operations Plan
NCSX-PLAN-MFOP-01

technicians and field crews, making recommendations for types of safety equipment to be used and how to perform work more safely.

7.1.12 Quality Control Representative

QC shall work as an independent group, reviewing field activities to ensure that procedures are being followed and that necessary travelers and data sheets are completed in a timely fashion. The QC representative shall apprise the Field Supervisors and Manufacturing Facility Manager of any concerns.

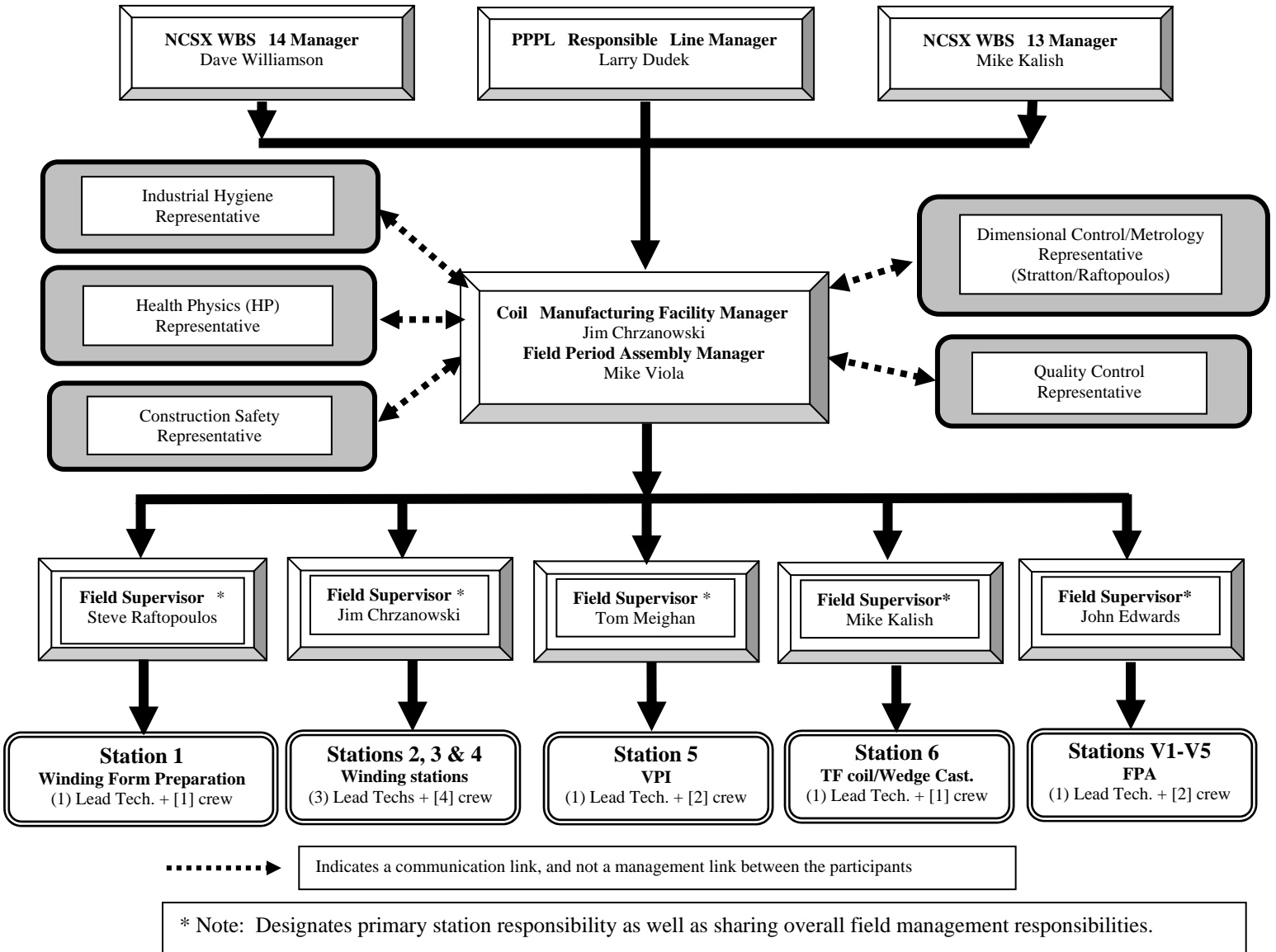

Figure 7-1-NCSX Coil Manufacturing Facility Organizational Chart

NCSX Manufacturing Facility Operations Plan
NCSX-PLAN-MFOP-01

7.2 General Facility Operating Guidelines

The following sections provide a brief overview of the operating guidelines for the NCSX Manufacturing Facility. All work within the NCSX Manufacturing Facility will be governed by the appropriate NEPA documentation, job hazard analysis, and work planning forms. The respective MIT/QA plans will identify the governing documentation.

7.3 Guidelines for Doing Work in the NCSX Manufacturing Facility

7.3.1 Field Supervisors

Shall be appointed by the Manufacturing Facility Managers and will supervise all field operations. Additionally during the MC and TF Coil production, a Field Supervisor will be on call to address any technical and personnel issues that may arise in the NCSX Manufacturing Facility during working hours.

7.3.2 House-Keeping/Cleanliness Rules

“Good House-Keeping” is an essential element to the success of the manufacturing of the modular coils. The following steps will be taken to enforce this practice.

7.3.3 Food, Smoking, Gum

No food, gum, smoking or beverage will be allowed in the NCSX Coil manufacturing facility. (Radiation Controlled Area “RCA”)

7.3.4 Clean Environment

The coil winding and molding preparation stations [Work Stations #2-4] are housed in a clean environment with walls, ceiling and filtered airflow.

7.3.5 Access to Work Stations #2-4

Only personnel associated with the coil manufacturing activities may enter Work Stations #2-4 unless approved by the Manufacturing Field Manager or Field Supervisors. Approved names will be posted outside each station.

7.3.6 Step-Off Pads

Step-off pads will be used at the entrances of workstations 2-4, to minimize transport of foreign particulate and dirt into the work area. In addition, some sort of approved protection may be worn over street shoes such as booties or other approved foot coverage while in these areas.

7.3.7 Special Clothing Recommendations

It is recommended that lab coats or Tyvex suits be worn by the crew during the winding and molding operations.

7.3.8 Daily Cleaning

The manufacturing stations will be cleaned daily by the coil work crew at the end of each shift.

NCSX Manufacturing Facility Operations Plan
NCSX-PLAN-MFOP-01

7.3.9 Gloves

Latex, rubber or cotton lint-free gloves will be required to be worn during the handling of insulated conductor, insulation, fillers or other components used in the construction of the modular coils.

7.3.10 Markers and Pencils:

The use of lead pencils or non-approved markers is **prohibited** in the fabrication stations. “Sharpie” permanent markers are the only markers that may be used without prior approval by the Field Supervisor.

7.3.11 Chips and Filings:

Extreme care must be taken when using files, grinders, etc. that could generate metal chips or filings. Surrounding areas must be protected from these activities. This type of work should be minimized near the coils whenever possible.

7.3.12 Hard hats

Hard hats are not required in the NCSX Manufacturing Facility unless the facility crane is in use. The following rules shall be followed if the crane is in use:

NCSX Manufacturing Facility Hard Hat Rules

While the overhead crane is powered up (crane lights are on), all personnel under or within 5 feet of the BRIDGE of the crane MUST be wearing hard hats. This includes walking under the bridge to enter or exit the Facility.

If the crane is in a powered down mode (lights are off), but there is a load suspended from the crane, all personnel under the TROLLEY of the crane must be wearing hard hats.

Crane operators must sound horn when powering up the crane. The person responsible for the lift must perform a visual inspection to ensure that all personnel under the bridge of the crane don hard hats before the crane is operated. This includes checking **ALL** clean rooms if the bridge is over that area of the facility. If the crane bridge is moving through the facility, the person responsible for the lift must ensure that all personnel in the path are wearing hard hats before the crane travels.

The person in charge of the lift must also ensure that there are signs and/or barriers outside the facility indicating that the crane is in use, and that hard hats are required.

7.3.13 Station Logbook

Each workstation will have a “Station Logbook” that will be filled in on a daily basis by the Lead Technician. Entries will include technical data associated with that station, daily progress, as well as problems and solutions that may arise.

**NCSX Manufacturing Facility Operations Plan
NCSX-PLAN-MFOP-01**

7.3.14 Daily Summary Report

A daily summary report, outlining the day's activities, will be issued by the Field Supervisor on duty at the end of the shift. This report will briefly outline the day's accomplishments as well as manufacturing issues he feels should be included. This report will be e-mailed to the NCSX project management. Note: These daily reports will begin once full production of the modular and TF coils starts.

8 Safety and Training Requirements

8.1 Integrated Safety Management (ISM)

PPPL ES&H 5008 defines the Integrated Safety Management principles for work being accomplished at the laboratory. ISM principles will be used throughout the coil manufacturing process and field period assembly. It is a "Common sense approach to **Doing Work Safely**". There are seven guiding principles for safety management:

- Line management responsibility for safety
- Clear roles and responsibilities
- Competence commensurate with responsibilities
- Balanced priorities
- Identification of safety standards and requirements
- Hazard controls tailored to work being performed
- Operations authorization

8.2 Project NEPA, Hazard Analysis, & Pre-Ops Safety Certifications

In accordance with specific PPPL directives and procedures, prior to any work being planned and accomplished within the NCSX Manufacturing Facility or stations operated, several prerequisite NEPA, project hazard analysis, and safety reviews and assessments documents were required. These included:

- Environmental assessments - PPPL procedure ESH-014, "NEPA Review System," establishes the environmental review assessment process for projects. A NEPA review and assessment was performed for the Modular and TF Coil Development and Production Program. NEPA 1283 documented the laboratory independent review of the planned activities within the NCSX Manufacturing Facility to ensure that they would comply with the National Environmental Act of 1969. It concluded that the coil development and production program fully satisfied DOE and laboratory orders and systems.
- The Project Hazard Analysis (PHA) - of the overall NCSX manufacturing program was intended to provide an overall description of the operations in the facility, their expected hazards and mitigation for the NCSX Manufacturing Facility. This PHA (NCSX-PHA-142-01) was accomplished in the late summer of 2004 and designated the Manufacturing Facility as a "moderate hazard" facility.

**NCSX Manufacturing Facility Operations Plan
NCSX-PLAN-MFOP-01**

- Pre-operation safety assessments - although the NCSX Manufacturing Facility was designated as a “moderate hazard” facility, the NCSX Project elected to request Activity Certification Committee (ACC) reviews prior to any station within the facility to be operated. ACC reviews are intended to provide a formalized, standardized means of assuring independent review and authorization of High Hazard operations designated in accordance with ES&H Directive 5008, Section 11, Chapter 1. These reviews are in addition to the NEPA reviews and certifications required by PPPL procedure ESH-014 (NEPA Review System”). Each designated operation in the NCSX Manufacturing Facility will be the subject of a separate ACC review.

8.3 Job Hazard Analysis Surveys and Safety Meetings

8.3.1 Specific Job Hazard Analyses

JHA’s will be generated for specific activities to identify existing or potential workplace hazards and to evaluate the risk of worker injury or illness associated with job tasks. (Reference document ESH-004 “Job Hazard Analysis”) The JHA’s will be reviewed by the IH representative for accuracy as well as completeness. It will be reviewed with all activity participants at the Pre-Job briefings.

8.3.2 Safety Meetings

There will be safety meetings typically every other week to discuss particular safety issues associated with the manufacturing of the modular coils and/or general safety related topics. (These meetings will commence once the production of the modular coils has begun)

- Time: The meetings will be held every other Tuesday and will address safety issues.
- Location: The meetings will generally be held in the Manufacturing Facility. However, they may be held in other areas such as the WCC trailer conference room as deemed appropriate for the topic being discussed.
- Chairman: Either a safety representative or a field supervisor will chair the meetings, as required.
- Attendees should include the Field Supervisors, Lead Technicians, Field Crews, Health Physics Representative, Industrial Hygiene Representative, Quality Control Representative and Construction Safety Representative. This list may change depending upon the topic of the meeting that day.

8.4 Safety Walk-Through’s

Daily safety Walk-Through’s will be performed by Industrial Hygiene, by Construction Safety and by field supervisors with the intention of identifying and correcting unsafe conditions or activities in the manufacturing area.

NCSX Manufacturing Facility Operations Plan
NCSX-PLAN-MFOP-01

8.5 Training:

Training of personnel is “Key” to completing the NCSX fieldwork safely. Courses will be required for all personnel, instructing them in the proper use of tools and equipment; personal protective equipment (PPE’s); and general laboratory policy and safety requirements. Coil Manufacturing and Field Period Assembly training matrixes will be developed to specifically identify the training required for the individual working in the manufacturing facility.

8.6 Personal Protective Equipment [PPE’s]

The PPPL Industrial Hygiene and Construction Safety representatives will work together with the Manufacturing Facility Manager to identify the necessary and correct personal protective equipment needed to ensure a healthy and safe work environment for the work force.

8.7 Radiation Controlled Area:

The NCSX manufacturing facility is located in a Radiation Controlled Area (RCA). Accordingly, all personnel entering the NCSX Manufacturing Facility must be Radiation Safety Qualified, must wear current radiation dosimetry, and must sign the Radiation Work Permit (RWP)/Access Log daily. Visitors may only enter if escorted by an individual RAD Safety qualified with a visitor’s radiation badge. The requirements for entering an RCA is described in procedure ESH-008 “Access to Radiological Areas (RCA’s)”

No food, gum, or beverage is allowed in the NCSX Manufacturing Facility because it is located in an RCA.

8.8 Emergency Response Procedure

In the event of abnormal conditions in the NCSX Manufacturing Facility during the epoxy impregnation operations (VPI), procedure “D-NCSX-OP-EO-41” identifies what actions should be taken. Abnormal conditions are identified as conditions which, if not corrected, could result in injury to personnel or damage to equipment. All employees working in the coil manufacturing facility will be required to read the emergency response procedure.

9 Meetings and Communication Requirements

Communication between management and the field crews is essential to ensure a successful and cohesive working group. In addition to the meetings described below, other meetings may be held “as required” to keep the work crew informed of laboratory or safety related items.

9.1 Daily Startup Meetings

There will be a Daily Startup Meeting to review inter-actions, planning, scheduling, safety and commitments for all activities associated with the Coil Manufacturing Facility. Additional meetings will be held between shifts for the purpose of exchanging information.

NCSX Manufacturing Facility Operations Plan
NCSX-PLAN-MFOP-01

- Time: The meetings will be held in the AM Monday thru Friday prior to the start of field activities and will address the day's scheduled activities. Additional meetings may be held during shift work activities to accommodate the transfer and needed information.
- Location: The meetings will normally be held in the NCSX Manufacturing Facility; however the location of meeting may also be in the WCC trailer conference room at D-site.
- Chairman: One of the Manufacturing Facility Managers (MFM) or his designee (Field Supervisor) will chair this meeting.
- Attendees should include one of the MFM, Field Supervisors, Lead Technicians, Field Crews, Health Physics Representative, Industrial Hygiene Representative, Quality Control Representative and Construction Safety Representative. This list may change depending upon the tasks being performed that day.

9.2 Pre-Job Briefings

Pre-job briefings are held prior to the start of any new work activity. The purpose of the briefing is to discuss specific work activities, responsibilities of the participants, a review of the JHA/safety issues, and to respond to all questions and concerns. In addition a review of post job briefings from previous, similar type operations may be appropriate. The participants at these briefings should include all individuals who will be involved with the activity including lead technician, field crews, and supervisors. Representatives from construction safety, Industrial Hygiene, Health Physics and Quality Control should be included as appropriate to the job.

9.3 Post-Job Briefings

A post-job briefing is held at the conclusion of a work activity. These briefings will be held at each station at the conclusion of the station activities. The purpose of the briefing is to discuss the completed work activities. It should include lessons learned including technique problems, improvements and safety related issues. Minutes from the post job briefings will be kept and filed with the run copy of the procedure. This information will be shared as deemed appropriate at the pre-job briefing of the next similar type operation. The participants at these briefings should include all individuals involved with the completed activity or procedure. It should include the lead technician, field crews, and supervisors. Representatives from construction safety, Industrial Hygiene, Health Physics and Quality Control will be included as appropriate to the job.

10 Documentation Requirements

10.1 Document Control

All NCSX associated documents used for manufacturing the NCSX coils and the Field Period Assemblies will be under NCSX Project document control. Any modifications to the procedures will be implemented using ENG-030.

NCSX Manufacturing Facility Operations Plan
NCSX-PLAN-MFOP-01

10.2 Field Packages

- Each coil will have a separate “Coil Field Package” that will follow the coil from station to station and each VVSA will have a corresponding “VVSA field package”. It will include all of the process procedures, QC inspection reports, photographs, test results, and measurements used to document completion of major activities. The Field Package will be further discussed in the MIT/QA plan.
- The Lead Technician, Field Supervisor and or Quality Control representative will document all critical completions in the procedure. This will be completed using the signer’s initials identifying the approver.
- The signoffs in the procedures will be filled out in a timely fashion once a particular activity has been completed.

10.3 Documents Retention and Storage

If paper documents, they should be stored in the Ops Center. If electronic documents, they will be stored on the NCSX web site. Per the NCSX Docs and Records Plan, they need to be retained until the machine is dismantled and disposed.

11 Quality Assurance/Quality Control Requirements

11.1 Quality Control during Manufacturing

Quality control during the manufacturing process will be the responsibility of all parties involved in the manufacturing (Field supervisors, technicians, and Quality Control representative)

11.2 Measurements

Measurements and tests will typically be performed by the work crews and engineering. The QC representative should be made aware of planned tests and measurements, but unless required by the procedures, need not be present.

11.3 Other Quality Control Representative Responsibilities

- The QC representative will review the field activities on a daily basis; checking for completion of documentation as well as compliance with the approved procedures.
- The QC representative will be a required signature on the procedure verifying that the station activities have been completed and that the coil or field period component may move to the next station.
- The QC representative will report to the laboratory appointed NCSX Quality Assurance representative. He/she will also inform the appropriate Facility Manager of any issues or concerns that may be uncovered.