

**Energy Industries of Ohio**

**Contract # S005242-F**

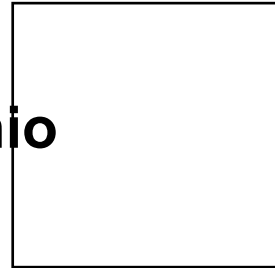

**Modular Coil Winding Forms**

**C-2 Documentation Package**

**Part 1 – Metal Tek International  
Casting Data Package**

**11/15/2005**

## C-2 Documentation Package

### List of Documents 11-15-2005

Doc #	Description	# Pages
4	MTR for weighted average of chemistry – 3 ladles replaced by product analysis	1
4a	MTR from Wisconsin Centrifugal	1
5	Chemistry of weld material Lot # 3012668/82743	1
6	Chemistry of weld material Lot # WO19711	1
7	Westmoreland Tensile test report @ -320°F dated 6-17-05	1
8	St Louis Test Lab dated 5-17-05 – incl. tensile test results @ room temp & Charpy V Notch (CVN) at 77°K & 293°K	7
9	Westmoreland tensile test results of weld material @ -320°F dated 4-28-05	1
10	St Louis Testing tensile test report of weld material @ RT dated 4-22-05	1
11	St Louis Testing CVN test report of weld material @ -320°F dated 4-6-05	2
12	St Louis Testing CVN test report of weld material @ RT dated 3-2-05 <i>note – page 2 of this report unrelated to project – added to show page 2 of 2</i>	2
13	Weld map list - revised	9
13a	RT photos	7
14	Final Inspection report	1
15	RT inspection reports from MQS dated 5-20-05 & 6-11-05	7
16	Metal Tek Radiographic Interpretation Report dated 6-15-05	1
17	Heat treat chart 4-28-05	1
18	Heat treat chart – stress relief dated 6-21-05	1
19	CA1292 for major welds dated 6-2-05	1
20	CA1292a for major welds dated 6-15-05	2
21	CA1302 test material – lack of direction dated 5-29-05 & signed 6-06-05	1
21a	CA 1323 – CA for sulfur & phosphorus readings dated 7/26/05 + addendum dated 8/17/05	5
21b	CA 1423 for non conforming Metrode chemistry	2
22	MQS Radiographic Technique Sheet dated 1-18-2005	5
23	Signed & dated MTS for C-2	11
24	Supplemental routing card for C-2 stress relief dated 6-21-05	1
25	Qualifying report from dimensional scan of C-2 dated 5-22-05	8
25a	Qualifying report from dimensional scan of C-2 dated 5-23-05	16
26	MTR C-2 shim revised 9/24/05	1
27	Westmoreland shim tensile tests @ -320°F	1
28	St Louis Testing Labs CVN shim material @ 77°K & 293°K + mechanical test results at RT dated 6-13-05	3
29	Final inspection report – C-2 shim dated 6-22-05	1
30	C-2 Shim C of C dated 6/21/05	1
31	CA1308 – chemistry out of spec	1
32	Metal Tek Radiographic Interpretation Report – C-2 shim dated 6-23-05	2
33	Heat treat chart – C-2 shim – dated 6-03-05	1
34	Dimensioned sketch C-2 shim dated 6-23-05	2
35	MTS – C-2 Shim dated & signed	6
36	EIO shipping release dated 6-27-05	2
11/15/05		



### Carondelet Division

8600 Commercial Blvd. - Pevely, MO 63070 USA  
Phone: 636-479-4499 - Fax: 636-479-3399

### Material Test Report

ENERGY INDUSTRIES OF OHIO

C-2 Doc Package  
Document # 4

Replaced by product  
analysis - See CA  
12323

Purchase Order Number PPPL-FP-LTS-2

Cert Number S75920-1

Pattern Number MCWF-C2

Pour Date 4/15/2005

CAF Metal Designation CF8MNMnMod

Material Spec CF8MNMnMOD

Weighted average of 3 heats - 29060(46%),29061(25%),29063(29%) Total Weight 29107 lbs.

Revised 10/26/05

Element	Min	Actual	Max
C	0.04	0.06	0.07
MN	2.3	2.8	2.8
SI	0.0	0.5	0.7
CR	18.0	18.0	18.5
NI	13.0	13.2	13.5
MO	2.1	2.3	2.5
P*	0.0	0.023	0.035
S*	0.0	0.018	0.025
N	0.24	0.26	0.28

\*P & S taken from cast on bar, zones 1,2,&3 and analyzed by wet chemistries, ASTM E1019-03 for sulfur and Colormetric for phosphorous.

#### PRODUCT ANALYSIS

Results of spectrometer analysis of cast on test bar after spectrometer preventive maintenance performed and at Wisconsin Centrifugal.

\*\*\*Not analyzed on spectrograph.

Element	CAF after PM	WC Analysis
C	***	0.07
MN	1.6	1.6
SI	0.8	.09
CR	18.2	18.2
NI	13.5	13.7
MO	2.3	2.2
P	0.024	0.023
S	0.012	0.014
N	***	0.23

Charles A. Ruud  
Quality Assurance Manager

Superior Quality Engineered Metal Products

[www.MetalTekInt.Com](http://www.MetalTekInt.Com)



## Carondelet Division

8600 Commercial Blvd. - Pevely, MO 63070 USA  
Phone: 636-479-4499 - Fax: 636-479-3399

C-2 Doc Package  
Document # 4a

## Material Test Report

ENERGY INDUSTRIES OF OHIO

Purchase Order Number PPPL-FP-LTS-2

Pattern Number MCWF-C2

CAF Metal Designation CF8MNMnMod

Material Spec CF8MNMnMOD

Analysis performed by Wisconsin Centrifugal

Cert Number S75920-1

Pour Date 4/15/2005

Revised 11/3/05

Element	Min	Actual	Max
C	0.04	0.07	0.07
MN*	2.3	1.6	2.8
SI*	0.0	0.9	0.7
CR	18.0	18.2	18.5
NI*	13.0	13.7	13.5
MO	2.1	2.2	2.5
P	0.0	0.023	0.035
S	0.0	0.014	0.025
N	0.24	0.23	0.28

\* See Corrective Action Number 1323.

Respectfully Submitted,  
Charles A. Ruud  
Quality Assurance Manager

Superior Quality Engineered Metal Products

[www.MetalTekInt.Com](http://www.MetalTekInt.Com)

# PRODUCT CONFORMANCE REPORT



Product LNM.4455  
 Class. EN 12072-99: G 20 16 3 Mn L

Size(s) mm 1,2  
 Lot/Batch 3012668/82743  
 Item No. 692129

C-2 Doc Package  
 Document # 5

Customer CK SUPPLY  
 Contact Ernie Simpson  
 Eureka (MISSOURI) 63025  
 UNITED STATES

Quantity  
 Customer ref. P.O.: SL056508  
 LSW Order No. SD418352

Chemical analysis (%)

EN10204 3.1B

C	Si	Mn	P	S	Cr	Ni	Mo	Cu	N
0,02	0,4	7,2	0,014	0,003	19,6	15,7	2,7	0,1	0,17

*Can't read that high J.G.*

Mechanical tests: all weld metal

EN10204

Additional information  
 Other tests

EN10204

Remarks

The product identified above has been manufactured, tested and supplied in compliance with a Quality Assurance Programme that fulfils the requirements of EN 29000/ ISO 9000:BS 5750 or similar standard.  
 We herewith certify that the product complies with the above-mentioned standards.  
 Certified ISO 9001:2000.

Company	Issued by	Function	Date	Cert.No.
Lincoln Smitweld B.V. Registered Office: Van der Dukenburgseweg, 201 6334 AD NIMMIGEN	 P. van Etteger	QS Manager	27/01/2005	3012668/8274
	Telephone: +31 24 3522931	Fax: +31 24 3522300		

METRODE PRODUCTS LIMITED  
HANWORTH LANE, CHERTSEY

**CERTIFIED MATERIAL  
TEST REPORT**



SURREY, UK, KT16 9LL

THIS PRODUCT HAS BEEN MANUFACTURED  
AND SUPPLIED THROUGH A SYSTEM  
APPROVED TO ISO 9001 & 2 OR EQUIVALENT

Tel: +44 (0) 1932 566721

Fax: +44 (0) 1932 565168

Email: info@metrode.com

Website: www.metrode.com



**TEST CERTIFICATE NUMBER**

175185

<b>INVOICE TO</b>
Euroweld Ltd
255 Rolling Hills Road
Mooresville
NC 28117
USA

<b>DESPATCHED TO</b>
Euroweld Ltd
255 Rolling Hills Road
Mooresville
NC 28117
USA

<b>CUSTOMER ORDER NUMBER</b>	N 03-134
<b>DELIVERY NOTE DOCUMENT NUMBER</b>	DN0096436
<b>QUANTITY (KG)</b>	40.5000
<b>OUR ORDER REFERENCE</b>	SO1777956 / 1
<b>DATE</b>	07/01/04

<b>METRODE WELDING CONSUMABLE</b>	ULTRAMET B316NF 4.0MM
<b>FORM</b>	MMA ELECTRODE
<b>BATCH NUMBER</b>	WO19711
<b>SPECIFICATION</b>	BS EN 1600:1997 E 18 15 3 L B 4 2

<b>Chemical Analysis (Weight %)</b>										<b>Type: BS EN 10204: 3.1.B / ASME SFA-5.01: Sch. H</b>	
C	Mn	Si	S	P	Cr	Ni	Mo	Cu	N		
0.02	3.28	0.24	0.009	0.023	18.0	15.4	2.80	0.07	0.11		

<b>Mechanical Tests</b>						<b>Type: BS EN 10204: 2.2</b>		
<b>Tensile Tests</b>						<b>Impact Energies</b>		
Condition	Test Temperature	Rp0.2% (MPa)	Rm (MPa)	A4 (%)	Z (%)	Temperature (°C)	Impact Energy (J)	Lateral Expansion (mm)
AS-WELDED	ROOM	>420	>600	38	54	-196	>40	

Metrode Products Limited certifies that the above material conforms to the indicated specifications

ASME SFA-5.01: Lot classification: C4

This document is produced electronically and is valid without signature.

IMPORTANT: Any liability arising from either reliance on this certificate, or use of our products, is strictly limited and governed by our conditions of business

Barrie Kyle - Q.A. Manager

Notes:  
% Ni includes incidental Co unless otherwise specified  
% Nb (Cb) includes incidental Ta unless otherwise specified  
Ferrite is given as FN (Ferrite number) and measured on all-weld pad using instrument calibrated against NBS-related secondary standards (See AWS A4 2-97) unless otherwise specified

**Westmoreland Mechanical Testing & Research, Inc.**  
 P.O. Box 388  
 Westmoreland Drive  
 Youngstown, Pa. 15696-0388 U.S.A.  
 Telephone: 724-537-3131 Fax: 724-537-3151  
 Website: www.wmtr.com  
 WMT&R is a technical leader in the material testing industry.



621-01 & 621-02

June 17, 2005

**CERTIFICATION**

MetalTek International  
 The Carondelet Division  
 8600 Commercial Blvd.  
 I-55 Industrial Park  
 Pevely, MO 63070-1528

Section 1 of 1

WMT&R Report No. 5-29323  
 Req. No. 5394

Attention: Rick Suria

Subject: All processes, performed upon the material as received, were conducted at WMT&R, Inc. in accordance with the WMT&R Quality Assurance Manual, Rev. 9, dated 4/1/2000.  
 The following tests were performed on this order: TENSILE

TENSILE RESULTS: ASTM E21-03a  
 SOAK TIME: 5 Minutes  
 SPEED OF TESTING: 0.0030 in./in./min., 0.0500 in./min./in.  
 MATERIAL: Metaltek CF8MNM1MOD

Sample	TestLog Number	Temp. °F	UTS ksi	0.2% YS ksi	Elong %	RA %	Modulus Msi	Codes	Ult Load lbf	0.2% YLD. lbf	Orig.		4D Orig		4D Final		Machine Number	AUIR
											Dia. (in.)	Di. (in.)	GL (in.)	Di. (in.)	GL (in.)	GL (in.)		
A1 (Z1)	C03040	-320	165.1	95.5	51	37	25.9	---	33210	19210	0.5060	0.4002	2.00	3.02	0.20109020	M9	R	
A1 (Z2)	C03041	-320	165.1	94.6	59	51	25.4	---	33120	16980	0.5054	0.3543	2.00	3.18	0.20061359	M9	R	
A1 (Z3)	C03042	-320	168.7	101.8	58	57	25.2	---	33840	20420	0.5054	0.3505	2.00	3.18	0.20061359	M9	R	
C2 (Z1)	C03043	-320	163.6	94.0	51	41	25.9	D	32840	18880	0.5056	0.3891	2.00	3.03	0.20077240	M9	R	
C2 (Z2)	C03044	-320	162.4	91.7	61	61	25.0	---	32580	16390	0.5054	0.3163	2.00	3.21	0.20061359	M9	R	
C2 (Z3)	C03045	-320	165.5	93.9	61	61	25.7	---	33230	18850	0.5056	0.3163	2.00	3.21	0.20077240	M9	R	

AUIR: A=ACCEPTABLE, U=UNACCEPTABLE, R=REPORT

D - Failed outside middle half of gage length.

*Matthew Johnston*  
 Roy E. Stammel Wojcik  
 Technical Services Manager / Tensile Supervisor  
 6-17-05  
 June 17, 2005

KNOWNLY OR WILLFULLY FALSIFYING OR CONCEALING A MATERIAL FACT ON THIS FORM OR MAKING FALSE, FICTITIOUS OR MISLEADING STATEMENTS OR REPRESENTATIONS HEREIN COULD CONSTITUTE FELAONY FALSIFYING A FEDERAL STATUTE. THE CERTIFICATE ON REPORT SHALL NOT BE REPRODUCED EXCEPT IN FULL WITHOUT THE WRITTEN APPROVAL OF WMT&R, INC.

Testing Specialists for Aerospace, Automotive, and Material Testing Fields  
 Locations in Youngstown, PA U.S.A. ~ Tel. (724) 537-3131 and  
 Banbury U.K. ~ Tel. +44 (0) 1295 261211



2810 Clark Avenue • St. Louis, MO 63103-2574 • (314) 531-8080 • FAX (314) 531-8085

**METALTEK INTERNATIONAL**  
 8600 Commercial Blvd.  
 Pevely, MO 63070

May 17, 2005  
 Lab No. 05P-1488  
 P.O. No. 12516  
 Page 1 of 7

C-2 Doc Package  
 Document # 8

**Attention: Chuck Ruud**

**REPORT OF MECHANICAL TESTS**

**SAMPLE ID: 3 Ea. C-2 COIL, #Z1, #Z2, & #Z3**

Sample ID	Original Area Sq. Inches	Reduced Area Sq. Inches	Reduction in Area %	Yield Strength PSI	Tensile Strength PSI	Elongation (2.0" Gage Length)		Modulus of Elasticity Msi
						in.	%	
#Z1	.1948	.0946	51.4	37,700	82,000	1.17	51.4	23.4
#Z2	.1948	.0887	54.5	35,900	81,000	1.03	51.5	23.2
#Z3	.1901	.0887	53.3	36,100	84,300	1.15	57.5	21.4

Round, reduced section tensiles

Yield taken at .2% offset

Tested in accordance with ASTM A 370

*Identification of tested specimens provided by the client*

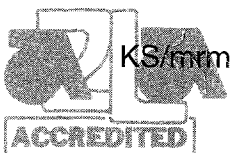

*Karl Schmitz*, Director  
 Materials Testing



Certificate No. 0397-01  
 Certificate No. 0397-02

AN OFFICIAL COPY OF TEST REPORT WILL BE PROVIDED BY THIS LABORATORY ON REQUEST. DO NOT REPRODUCE.  
 NOT OFFICIAL WITHOUT THE RAISED SEAL OF ST. LOUIS TESTING LABORATORIES, INC.  
 SEE REVERSE FOR CONDITIONS.





2810 Clark Avenue • St. Louis, MO 63103-2574 • (314) 531-8080 • FAX (314) 531-8085

**METALTEK INTERNATIONAL**  
 8600 Commercial Blvd.  
 Pevely, MO 63070

May 17, 2005  
 Lab No. 05P-1488  
 P.O. No. 12516  
 Page 2 of 7

**Attention: Chuck Ruud**

C-2 Doc Package  
 Document # 8

**REPORT OF CHARPY IMPACT TEST**

**MATERIAL (SAMPLE ID):** C-2 COIL, #Z1  
**SPECIFICATION:** ASTM A 370-03a  
**SPECIMEN TYPE:** "A" Vee Notch  
**SPECIMEN SIZE:** 10 mm x 10 mm  
**TEMPERATURE OF TEST:** 293°K

**RESULTS:**

BASE METAL	FOOT LBS.	LATERAL EXPANSION	% SHEAR
Z1-1	140	.106	100
Z1-2	128	.059	70
Z1-3	150	.126	100
<u><b>AVERAGE</b></u>	139	.097	90

*Identification of tested specimen provided by client.*



Certificate No. 0397-01  
 Certificate No. 0397-02

*Karl Schmitz*  
 Karl Schmitz, Director  
 Materials Testing

AN OFFICIAL COPY OF TEST REPORT WILL BE PROVIDED BY THIS LABORATORY ON REQUEST. DO NOT REPRODUCE.  
 NOT OFFICIAL WITHOUT THE RAISED SEAL OF ST. LOUIS TESTING LABORATORIES, INC.  
 SEE REVERSE FOR CONDITIONS.





2810 Clark Avenue • St. Louis, MO 63103-2574 • (314) 531-8080 • FAX (314) 531-8085

**METALTEK INTERNATIONAL**  
 8600 Commercial Blvd.  
 Pevely, MO 63070

May 17, 2005  
 Lab No. 05P-1488  
 P.O. No. 12516  
 Page 3 of 7

**Attention: Chuck Ruud**

C-2 Doc Package  
 Document # 8

**REPORT OF CHARPY IMPACT TEST**

**MATERIAL (SAMPLE ID):** C-2 COIL, #Z1  
**SPECIFICATION:** ASTM A 370-03a  
**SPECIMEN TYPE:** "A" Vee Notch  
**SPECIMEN SIZE:** 10 mm x 10 mm  
**TEMPERATURE OF TEST:** 77°K

**RESULTS:**

BASE METAL	FOOT LBS.	LATERAL EXPANSION	% SHEAR
Z1-4	90	.045	60
Z1-5	80	.049	60
Z1-6	81	.055	60
<u><b>AVERAGE</b></u>	84	.050	60

*Identification of tested specimen provided by client.*



Certificate No. 0397-01  
 Certificate No. 0397-02

*Karl Schmitz*  
 Karl Schmitz, Director  
 Materials Testing

AN OFFICIAL COPY OF TEST REPORT WILL BE PROVIDED BY THIS LABORATORY ON REQUEST. DO NOT REPRODUCE.  
 NOT OFFICIAL WITHOUT THE RAISED SEAL OF ST. LOUIS TESTING LABORATORIES, INC.  
 SEE REVERSE FOR CONDITIONS.





2810 Clark Avenue • St. Louis, MO 63103-2574 • (314) 531-8080 • FAX (314) 531-8085

**METALTEK INTERNATIONAL**  
 8600 Commercial Blvd.  
 Pevely, MO 63070

May 17, 2005  
 Lab No. 05P-1488  
 P.O. No. 12516  
 Page 4 of 7

**Attention: Chuck Ruud**

C-2 Doc Package  
 Document # 8

**REPORT OF CHARPY IMPACT TEST**

**MATERIAL (SAMPLE ID):** C-2 COIL, #Z2  
**SPECIFICATION:** ASTM A 370-03a  
**SPECIMEN TYPE:** "A" Vee Notch  
**SPECIMEN SIZE:** 10 mm x 10 mm  
**TEMPERATURE OF TEST:** 293°K

**RESULTS:**

BASE METAL	FOOT LBS.	LATERAL EXPANSION	% SHEAR
Z2-1	140	.118	100
Z2-2	154	.090	90
Z2-3	150	.109	100
<b><u>AVERAGE</u></b>	148	.105	97

*Identification of tested specimen provided by client.*



*Karl Schmitz*  
 Karl Schmitz, Director  
 Materials Testing

AN OFFICIAL COPY OF TEST REPORT WILL BE PROVIDED BY THIS LABORATORY ON REQUEST. DO NOT REPRODUCE.  
 NOT OFFICIAL WITHOUT THE RAISED SEAL OF ST. LOUIS TESTING LABORATORIES, INC.  
 SEE REVERSE FOR CONDITIONS.



Certificate No. 0397-01  
 Certificate No. 0397-02

2810 Clark Avenue • St. Louis, MO 63103-2574 • (314) 531-8080 • FAX (314) 531-8085

**METALTEK INTERNATIONAL**  
 8600 Commercial Blvd.  
 Pevely, MO 63070

May 17, 2005  
 Lab No. 05P-1488  
 P.O. No. 12516  
 Page 5 of 7

**Attention: Chuck Ruud**

**REPORT OF CHARPY IMPACT TEST**

C-2 Doc Package  
Document # 8

**MATERIAL (SAMPLE ID):** C-2 COIL, #Z2  
**SPECIFICATION:** ASTM A 370-03a  
**SPECIMEN TYPE:** "A" Vee Notch  
**SPECIMEN SIZE:** 10 mm x 10 mm  
**TEMPERATURE OF TEST:** 77°K

**RESULTS:**

BASE METAL	FOOT LBS.	LATERAL EXPANSION	% SHEAR
Z2-4	88	.071	90
Z2-5	76	.037	60
Z2-6	86	.057	70
<u>AVERAGE</u>	83	.055	73

*Identification of tested specimen provided by client.*

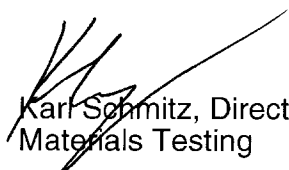

Certificate No. 0397-01  
 Certificate No. 0397-02

  
 Karl Schmitz, Director  
 Materials Testing

AN OFFICIAL COPY OF TEST REPORT WILL BE PROVIDED BY THIS LABORATORY ON REQUEST. DO NOT REPRODUCE.  
 NOT OFFICIAL WITHOUT THE RAISED SEAL OF ST. LOUIS TESTING LABORATORIES, INC.  
 SEE REVERSE FOR CONDITIONS.





2810 Clark Avenue • St. Louis, MO 63103-2574 • (314) 531-8080 • FAX (314) 531-8085

**METALTEK INTERNATIONAL**  
 8600 Commercial Blvd.  
 Pevely, MO 63070

May 17, 2005  
 Lab No. 05P-1488  
 P.O. No. 12516  
 Page 6 of 7

**Attention: Chuck Ruud**

C-2 Doc Package  
 Document # 8

**REPORT OF CHARPY IMPACT TEST**

**MATERIAL (SAMPLE ID):** C-2 COIL, #Z3  
**SPECIFICATION:** ASTM A 370-03a  
**SPECIMEN TYPE:** "A" Vee Notch  
**SPECIMEN SIZE:** 10 mm x 10 mm  
**TEMPERATURE OF TEST:** 293°K

**RESULTS:**

BASE METAL	FOOT LBS.	LATERAL EXPANSION	% SHEAR
Z3-1	154	.086	100
Z3-2	200	.061	100
Z3-3	142	.080	90
<u>AVERAGE</u>	165	.076	97

*Identification of tested specimen provided by client.*



Certificate No. 0397-01  
 Certificate No. 0397-02

*Karl Schmitz*  
 Karl Schmitz, Director  
 Materials Testing

AN OFFICIAL COPY OF TEST REPORT WILL BE PROVIDED BY THIS LABORATORY ON REQUEST. DO NOT REPRODUCE.  
 NOT OFFICIAL WITHOUT THE RAISED SEAL OF ST. LOUIS TESTING LABORATORIES, INC.  
 SEE REVERSE FOR CONDITIONS.





2810 Clark Avenue • St. Louis, MO 63103-2574 • (314) 531-8080 • FAX (314) 531-8085

**METALTEK INTERNATIONAL**  
 8600 Commercial Blvd.  
 Pevely, MO 63070

May 17, 2005  
 Lab No. 05P-1488  
 P.O. No. 12516  
 Page 7 of 7

**Attention: Chuck Ruud**

C-2 Doc Package  
 Document # 8

**REPORT OF CHARPY IMPACT TEST**

**MATERIAL (SAMPLE ID):** C-2 COIL, #Z3  
**SPECIFICATION:** ASTM A 370-03a  
**SPECIMEN TYPE:** "A" Vee Notch  
**SPECIMEN SIZE:** 10 mm x 10 mm  
**TEMPERATURE OF TEST:** 77°K

**RESULTS:**

BASE METAL	FOOT LBS.	LATERAL EXPANSION	% SHEAR
Z3-4	91	.052	80
Z3-5	86	.050	80
Z3-6	81	.061	80
<b><u>AVERAGE</u></b>	86	.054	80

*Identification of tested specimen provided by client.*



*Karl Schmitz*  
 Karl Schmitz, Director  
 Materials Testing

AN OFFICIAL COPY OF TEST REPORT WILL BE PROVIDED BY THIS LABORATORY ON REQUEST. DO NOT REPRODUCE.  
 NOT OFFICIAL WITHOUT THE RAISED SEAL OF ST. LOUIS TESTING LABORATORIES, INC.  
 SEE REVERSE FOR CONDITIONS.



Certificate No. 0397-01  
 Certificate No. 0397-02

**Westmoreland Mechanical Testing & Research, Inc.**  
 P.O. Box 388  
 Westmoreland Drive  
 Youngstown, Pa. 15696-0388 U.S.A.  
 Telephone: 724-537-3131 Fax: 724-537-3151  
 Website: [www.wmtr.com](http://www.wmtr.com)  
 WMTR is a technical leader in the material testing industry.



621-01 & 621-02

Section 1 of 1  
 WMT&R Report No. 5-26097  
 P.O. No. 19386R9  
 WMT&R Quote No. QN250563  
 Req. No. 4315

**CERTIFICATION**

April 28, 2005  
 MetalTek International  
 The Carondelet Division  
 8600 Commercial Blvd.  
 I-55 Industrial Park  
 Pevely, MO 63070-1528

Attention: Rick Suria  
 Subject: All processes, performed upon the material as received, were conducted at WMT&R, Inc. in accordance with the WMT&R Quality Assurance Manual, Rev. 9, dated 4/1/2000. The following tests were performed on this order: TENSILE

TENSILE RESULTS: ASTM E21-03a  
 Requirements: UTS ksi (Min 95/Max ---) 0.2% YS ksi (Min 72/Max ---) 4D Elong. % (Min 32/Max ---) Modulus Msi (Min 21/Max ---)  
 SOAK TIME: 5 Minutes  
 SPEED OF TESTING: 0.0050 in./in./min., 0.0500 in./min./in.  
 MATERIAL: 316 S/S

Sample	TestLog Number	Temp. °F	UTS ksi	0.2% YS ksi	Elong %	RA %	Modulus Msi	Ult. Load lbf	0.2% YLD. lbf	Orig. Dia. (in.)	Final Dia. (in.)	4D		Machine Number	AIUR	
												Orig. GL (in.)	Final GL (in.)			
Bar#1 (Lot#3012668/82743)	B75123	-320	187.7	126.3	33	22	27.1	37740	25394	0.5060	0.4471	2.00	2.65	0.20109020	M9	A
Bar#2 (Batch#W019711)	B75124	-320	166.9	109.5	34	27	26.4	33500	21990	0.5056	0.4315	2.00	2.67	0.20077240	M9	A

*D. J. [Signature]*

*Matthew [Signature]*  
 Roy E. Starr, Material Testing Supervisor  
 Technical Services Manager  
 April 28, 2005

Testing Specialists for Aerospace, Automotive, and Material Testing Fields  
 Locations in Youngstown, PA U.S.A. ~ Tel. (724) 537-3131 and  
 Banbury U.K. ~ Tel. +44 (0) 1295 261211

C-2 Doc Package  
 Document # 9

KNOWINGLY OR WILLFULLY FALSIFYING OR CONCEALING A MATERIAL FACT ON THIS FORM OR MAKING FALSE, FICTITIOUS OR FRAUDULENT STATEMENTS OR REPRESENTATIONS HEREIN COULD CONSTITUTE A FELONY PUNISHABLE UNDER FEDERAL STATUTES. THIS CERTIFICATE OR REPORT SHALL NOT BE REPRODUCED EXCEPT IN FULL, WITHOUT THE WRITTEN APPROVAL OF WMTR, INC.



10  
C-2 Doc Package  
Document # 10

2810 Clark Avenue • St. Louis, MO 63103-2574 • (314) 531-8080 • FAX (314) 531-8085

**METALTEK INTERNATIONAL**  
8600 Commercial Blvd.  
Pevely, MO 63070

April 22, 2005  
Lab No. 05P-1170  
P.O. No. 12516  
Page 1 of 1  
(revised 6/15/05)

Attention: **Chuck Ruud**

**REPORT OF MECHANICAL TESTS**

**SAMPLE ID:** 1 Ea., Sample Bar #1, Lot 3012668/82743  
1 Ea., Sample Bar #2, Batch # WO19711

Sample ID	Original Area Sq. Inches	Reduced Area Sq. Inches	Reduction in Area %	Yield Strength PSI	Tensile Strength PSI	Elongation (2.0" Gage Length)		Elastic Modulus
						in.	%	
#1	.1901	.0855	55.0	56,500	85,000	0.80	55.0	25.5 MSI
#2	.1917	.0881	54.0	63,900	98,100	0.88	54.0	23.1 MSI

Round, reduced section all weld room temperature tensiles

Yield taken at .2% offset

Tested in accordance with ASTM A 370  
*Identification of tested specimens provided by the client*

KS/tw

  
Karl Schmitz, Director  
Materials Testing



Certificate No. 0597-01  
Certificate No. 0597-02

AN OFFICIAL COPY OF TEST REPORT WILL BE PROVIDED BY THIS LABORATORY ON REQUEST. DO NOT REPRODUCE.  
NOT OFFICIAL WITHOUT THE RAISED SEAL OF ST. LOUIS TESTING LABORATORIES, INC.  
SEE REVERSE FOR CONDITIONS.







C-2 Doc  
 Package  
 Document # 11

2810 Clark Avenue • St. Louis, MO 63103-2574 • (314) 531-8080 • FAX (314) 531-8085

**METALTEK INTERNATIONAL**  
 8600 Commercial Blvd.  
 Pevely, MO 63070

April 6, 2005  
 Lab No. 05P-1007  
 P.O. No. 12516  
 Page 1 of 2

Attention: **Chuck Ruud**

**REPORT OF CHARPY IMPACT TEST**

**MATERIAL (SAMPLE ID):** 1 Ea., Material (1) LNM4455, Lot # 3012668/82743  
**SPECIFICATION:** ASTM A 370-03a  
**SPECIMEN TYPE:** "A" Vee Notch  
**SPECIMEN SIZE:** 10 mm x 10 mm  
**TEMPERATURE OF TEST:** -320°F

ALL WELD METAL	FOOT LBS.	LATERAL EXPANSION	% SHEAR
LNM4455-1	52	0.027	40
LNM4455-2	50	0.022	40
LNM4455-3	50	0.016	20
<b>Average</b>	51	0.022	33

*Identification of tested specimen provided by client.*

KS/tw

*[Signature]*  
 Karl Schmitz, Director  
 Materials Testing



Certificate No. 0347-01  
 Certificate No. 0357-02

AN OFFICIAL COPY OF TEST REPORT WILL BE PROVIDED BY THIS LABORATORY ON REQUEST, DO NOT REPRODUCE.  
 NOT OFFICIAL WITHOUT THE RAISED SEAL OF ST. LOUIS TESTING LABORATORIES, INC.  
 SEE REVERSE FOR CONDITIONS.





2810 Clark Avenue • St. Louis, MO 63103-2574 • (314) 531-8080 • FAX (314) 531-8085

C-2 Doc Package  
Document # 11

**METALTEK INTERNATIONAL**  
8600 Commercial Blvd.  
Pevely, MO 63070

April 6, 2005  
Lab No. 05P-1007  
P.O. No. 12516  
Page 2 of 2

Attention: Chuck Ruud

**REPORT OF CHARPY IMPACT TEST**

**MATERIAL (SAMPLE ID):** (2) Metrode B316NF, Batch # WO19711  
**SPECIFICATION:** ASTM A 370-03a  
**SPECIMEN TYPE:** "A" Vee Notch  
**SPECIMEN SIZE:** 10 mm x 10 mm  
**TEMPERATURE OF TEST:** -320°F

ALL WELD METAL	FOOT LBS.	LATERAL EXPANSION	% SHEAR
B316NF-1	48	0.030	30
B316NF-2	52	0.027	30
B316NF-3	44	0.027	30
<b>Average</b>	48	0.028	30

Identification of tested specimen provided by client.

KS/tw

*Karl Schmitz*  
Karl Schmitz, Director  
Materials Testing



AN OFFICIAL COPY OF TEST REPORT WILL BE PROVIDED BY THIS LABORATORY ON REQUEST. DO NOT REPRODUCE.  
NOT OFFICIAL WITHOUT THE RAISED SEAL OF ST. LOUIS TESTING LABORATORIES, INC.  
SEE REVERSE FOR CONDITIONS.



Certificate No. 0387-01  
Certificate No. 0397-02

12



2810 Clark Avenue • St. Louis, MO 63103-2574 • (314) 531-8080 • FAX (314) 531-8085

**METALTEK INTERNATIONAL**  
8600 Commercial Blvd.  
Pevely, MO 63070

C-2 Doc Package  
Document # 12

February 28, 2005  
Lab No. 05P-0554  
P.O. No. 12516  
Page 1 of 2  
(Revised Report 3-2-05)

Attention: Rick Suria

**REPORT OF CHARPY IMPACT TEST**

**MATERIAL (SAMPLE ID):** Electrode LNM 4455 & B316NF *30126682743*

**SPECIFICATION:** ASTM A 370-03a *L W01974*

**SPECIMEN TYPE:** "A" Vee Notch, All Weld *Chk 6/14/05*

**SPECIMEN SIZE:** 10 mm x 10 mm

**TEMPERATURE OF TEST:** +70°F

**RESULTS:**

ALL WELD	JOULES	FOOT LBS.	LATERAL EXPANSION	% SHEAR
LNM 4455-7	149	110	0.055	50
LNM 4455-8	130	96	0.050	50
LNM 4455-9	134	99	0.051	50
<b>Average</b>	<b>138</b>	<b>102</b>	<b>0.052</b>	<b>50</b>
ALL WELD	JOULES	FOOT LBS.	LATERAL EXPANSION	% SHEAR
B316NF-7	155	114	0.056	50
B316NF-8	151	111	0.053	50
B316NF-9	146	108	0.052	50
<b>Average</b>	<b>151</b>	<b>111</b>	<b>0.054</b>	<b>50</b>

Identification of tested specimen provided by client.

*[Signature]*  
Karl Schmitz, Director  
Materials Testing



Certificate No. 0397-01  
Certificate No. 0397-02

AN OFFICIAL COPY OF TEST REPORT WILL BE PROVIDED BY THIS LABORATORY ON REQUEST. DO NOT REPRODUCE.  
NOT OFFICIAL WITHOUT THE RAISED SEAL OF ST. LOUIS TESTING LABORATORIES, INC.  
SEE REVERSE FOR CONDITIONS.





2810 Clark Avenue • St. Louis, MO 63103-2574 • (314) 531-8080 • FAX (314) 531-8085

**METALTEK INTERNATIONAL**  
 8600 Commercial Blvd.  
 Pevely, MO 63070

C-2 Doc Package  
 Document # 12  
 (unrelated to C-2)

February 28, 2005  
 Lab No. 05P-0554  
 P.O. No. 12516  
 Page 2 of 2  
 (Revised Report 3-2-05)

Attention: Rick Suria

**PROCEDURE QUALIFICATION**

**WELDER:** TERRY STANFIELD  
**MATERIAL:** 1" CF8MnMn, Mod  
**SPECIFICATION:** ASME IX  
**ELECTRODE:** B316NF  
**PROCESS:** SMAW

*This is unrelated  
 to report for C-2  
 Cfr*

**REDUCED SECTION TENSILE**

SAMPLE ID	WIDTH INCHES	THICKNESS INCHES	AREA SQ. INCHES	ACTUAL LBS.	TENSILE STRENGTH PSI	FRACTURE
TS-2	.750	1.000	.7500	70,000	93,300	Weld Metal
TS-5	.750	1.010	.7575	71,000	93,700	Weld Metal

**GUIDED BEND TEST**

SAMPLE ID	BEND	RESULTS
TS-1	Side	Acceptable, No Discontinuities
TS-3	Side	Acceptable, No Discontinuities
TS-4	Side	Acceptable, No Discontinuities
TS-6	Side	Acceptable, No Discontinuities

KS/clm

*[Signature]*  
 Karl Schmitz, Director  
 Materials Testing  
 CWI No. 92120161



Certificate No. 0397-01  
 Certificate No. 0397-02

AN OFFICIAL COPY OF TEST REPORT WILL BE PROVIDED BY THIS LABORATORY ON REQUEST. DO NOT REPRODUCE. NOT OFFICIAL WITHOUT THE RAISED SEAL OF ST. LOUIS TESTING LABORATORIES, INC. SEE REVERSE FOR CONDITIONS.



## C-2 COIL WELD MAP

Defect Number	Photo Number	Length Inches	Width Inches	Depth Inches	Over 10% Wall Yes/No	Weld Permeability Result
1	11	2 1/2	1 3/4	1/2	No	Acceptable
2	11	1 1/2	3/4	1/8	No	
3	23	2 3/4	1 1/4	3/8	No	
4	23	2	1 1/2	1/4	No	
5	23	2 7/8	1 1/4	3/8	No	
6	23	3/4	1/2	3/8	No	
7	23	7	1 1/2	3/8	No	
8	23	2 1/4	1 1/2	5/8	No	
9	23	2 3/4	1 1/4	1/4	No	
10	23	3 1/2	1 1/4	1/4	No	
11	23	1 3/4	1	3/8	No	
12	24	4	3	1/2	No	
13	24	13 1/2	3 3/4	1/2	Yes	
14	24	2 1/2	1 1/2	1/8	No	
15	16	2 3/4	1	1/4	No	
16	16	2 1/2	1 1/2	3/4	No	
17	16	4	2 1/2	1/2	No	
18	16	2	2	1	Yes	
19	16	1 1/2	3/4	3/4	No	
20	16	2	1 1/4	1	Yes	
21	16	6	4	1 1/4	Yes	
22	14	2 3/4	2	2/8	Yes	
23	14	3 1/2	2 7/8	1/4	No	
24	14	2 1/2	1 3/4	1/4	No	
25	14	5	1	5/8	No	
26	19	2	1 5/8	1/2	No	
27	19	1 3/4	1 1/2	1/4	No	
28	19	6	5	1/4	No	
29	29	2	2	1/4	No	
30	29	4 7/8	3 3/4	1/4	No	
31	29	7	4	7/8	Yes	
32	29	2 1/4	2	1/4	No	
33	29	2	1	1/4	No	↓

## C-2 COIL WELD MAP

Defect Number	Photo Number	Length Inches	Width Inches	Depth Inches	Over 10% Wall Yes/No	Weld Permeability Result
34	15	2	1 1/4	1/4	No	Acceptable
35	15	2 1/2	2	1/4	No	
36	15	2	1	1/8	No	
37	15	1 1/2	1	1/8	No	
38	15	2	1 1/2	3/8	No	
39	15	4 1/2	2	1/4	No	
40	15	2 1/2	1 1/2	3/8	No	
41	15	3	1 1/2	1/4	No	
42	15	3 1/2	2 1/2	1/4	No	
43	20	3 1/4	3	1/2	No	
44	20	2 1/2	3/4	1/2	No	
45	20	3 1/4	1	1/4	No	
46	18	8 3/4	2	1/4	No	
47	18	8	2 1/2	1/4	Yes	
48	16	6	3	1/4	No	
49	16	2	1 1/2	1/4	No	
50	16	4	2	1/4	No	
51	46	2 1/2	2	1/8	No	
52	16	3 1/2	2 1/2	1	Yes	
53	46	4 1/2	4	1	Yes	
54	46	1	1	1/4	No	
55	46	6 3/4	2 1/2	1/2	Yes	
56	46	1	1	1/4	No	
57	46	1 1/2	1	1/4	No	
58	46	3 1/2	2	1/8	No	
59	46	6 3/4	1	1/8	No	
60	45	1 1/2	1 1/2	3/4	Yes	
61	45	4 1/2	3 1/2	1/4	No	
62	45	20	5	1	Yes	
63	45	13	4	3	Yes	
64	14	3/4	1/2	1/8	No	
65	16	2 1/2	2	1/4	No	
66	16	3/4	1/2	1/8	No	

## C-2 COIL WELD MAP

Defect Number	Photo Number	Length Inches	Width Inches	Depth Inches	Over 10% Wall Yes/No	Weld Permeability Result
67	45	10 1/2	4 1/4	2	Yes	Acceptable
68	14	3/4	1/2	1/8	No	↓
69	14	4 1/2	3	1/4	No	
70	14	3	1 1/2	1/4	No	
71	14	3	1	1/2	Yes	
72	45	1	1	1/4	No	
73	45	1 1/4	1/4	1/8	No	
74	47	1 1/2	1 1/2	3/4	Yes	
75	47	3/4	3/4	1/8	No	
76	47	2	1/2	3/16	No	
77	47	<del>3</del> 4	2 1/2	1/2	Yes	
78	47	1	1/2	1/4	No	
79	47	2 1/2	2	1/4	No	
80	47	7	3	3/8	Yes	
81	19	2 1/2	2	1/4	No	
82	47	1 1/2	1 1/2	1/4	No	
83	47	4	2 1/2	5/8	No	
84	19	2	1/2	1/4	No	
85	19	1 1/2	1	3/4	No	
86	19	7 1/2	5	3	Yes	
87	19	3 1/2	2	1/4	No	
88	19	4	2 1/2	5/8	No	
89	19	3 1/2	3	1/2	Yes	
90	19	2 1/2	2	1/4	No	
91	19	2	3/4	1/4	No	
92	19	9	4	1	Yes	
93	19	1 1/2	1	1/4	No	
94	19	4	3	1/4	No	
95	19	4 1/8	4	1/4	No	
96	19	6	3	1/4	No	
97	19	3	2 1/2	3/4	Yes	
98	19	2 1/2	1	3/4	Yes	
99	25	4	4	1 1/4	Yes	
100	25	2 1/2	2 1/2	1/2	No	
101	25	2 1/2	2 1/2	1 1/2	Yes	

## C-2 COIL WELD MAP

Defect Number	Photo Number	Length Inches	Width Inches	Depth Inches	Over 10% Wall Yes/No	Weld Permeability Result	
102	25	2 1/2	2 1/2	1/2	Yes	Acceptable	
103	36	2	1	1/4	No		
104	36	2 4	6	1	Yes		
105	36	3	2	1/4	No		
106	29	2 1/2	1 1/2	3/4	Yes		
107	29	1	1	1/4	No		
108	29	3/4	3/4	1/8	No		
109	29	6	3	1	Yes		
110	17	1	1	1/8	No		
111	17	8	5	1	Yes		
112	17	7	4	1	Yes		
113	Deleted	-	-	-	-		-
114	17	2 1/2	2	1	Yes		
115	17	3 1/2	7/8	3/4	Yes		
116	17	5	3	3/4	Yes		
117	17	1 1/2	1 1/2	1/4	No		
118	17	2 1/2	1 3/4	1/4	No		
119	17	10	5	1	Yes		
120	Deleted	-	-	-	-		-
121	17	1	1/2	1/2	Yes		
122	17	10	2 1/2	1 3/4	Yes		
123	17	2 1/2	2	1/4	No		
124	17	2	1 1/2	1/2	Yes		
125	17	3	2 3/4	1	Yes		
126	15	4 1/2	3 1/2	3/4	Yes		
127	15	1 1/2	1	1/4	No		
128	15	4	2 1/2	1/4	No		
129	15	2	1 1/2	1/4	No		
130	15	2	1	1/4	No		
131	15	2	1/2	1/4	No		
132	31	1 1/2	1	1/4	No		
133	31	2 1/2	1	1/2	Yes		
134	31	3	1	1/2	Yes		
135	31	2 1/2	2	1/2	Yes		
136	31	2	1	1/4	No		
137	31	1	1	1/4	No		
138	31	2	1	1/4	No		



## C-2 COIL WELD MAP

Defect Number	Photo Number	Length Inches	Width Inches	Depth Inches	Over 10% Wall Yes/No	Weld Permeability Result
139	31	7	5 1/2	1/2	Yes	Acceptable
140	31	2	1	1/4	No	
141	31	5	2	1/2	Yes	
142	31	2 1/2	2	1/4	No	
143	19	5	2 3/4	1/8	No	
144	19	5	2 1/2	1/4	No	
145	19	1 1/2	1	1/8	No	
146	19	3	2 1/2	1/4	No	
147	19	3	2 1/2	1/4	No	
148	34	12	3	1	Yes	
149	82	1 1/2	1	1/4	No	
150	41	3	2	1/8	No	
151	22	6	2	1/8	No	
152	22	1 1/2	1 1/2	1	Yes	
153	24	3	1 1/2	1/8	No	
154	24	2 3/4	1	1/8	No	
155	44	3	1 1/2	1	Yes	
156	42	2	1	1/4	No	
157	42	2	1	1/2	Yes	
158	42	2	1	1/4	No	
159	42	3	2 3/4	1 1/2	Yes	
160	42	3	2	5/8	Yes	
161	42	6	2	1	Yes	
162	42	4 1/2	1	3/4	Yes	
163	42	1	1/2	1/2	Yes	
164	42	2 1/2	1	1/8	No	
165	42	2	1 1/4	1/4	No	
166	42	3	2	1/4	No	
167	42	1 1/2	1	1/8	No	
168	42	3	2	1/8	No	
169	42	13	2	1 3/4	Yes	
170	42	2	1	1/2	Yes	
171	42	2	1	1/8	No	
172	42	2 1/2	1 3/4	1/4	No	
173	42	2	1	1/8	No	
174	42	2	1	1/8	No	
175	23	3	2 1/2	1/8	No	

## C-2 COIL WELD MAP

Defect Number	Photo Number	Length Inches	Width Inches	Depth Inches	Over 10% Wall Yes/No	Weld Permeability Result
176	23	2	1	1/8	no	Acceptable
177	23	2	1	1/8	no	
178	8	3	1 3/4	1/4	no	
179	8	2	1	1/8	no	
180	8	3 1/2	2	1/4	no	
181	8	3	1/4	1/8	no	
182	8	4	2	1/4	no	
183	8	3	2	1/2	yes	
184	6	1	1	1/4	no	
185	6	2 3/4	1	1	yes	
186	6	1	1	1/4	no	
187	3	2	1	1/4	no	
188	3	3 1/2	2	1/4	no	
189	21	3	2	1/4	no	
190	8	2 1/2	2	1/4	no	
191	8	2 1/2	1	3/4	yes	
192	8	4	3	1/2	yes	
193	8	8	1 1/2	1	yes	
194	8	19	2	1/2	yes	
195	8	2 3/4	2	1/2	yes	
196	26	6	1 3/4	2	yes	
197	26	1 1/2	1	1/2	yes	
198	26	3	2	1/4	no	
199	26	2	1 1/4	1/4	no	
200	26	4	3	1/4	no	
201	8	1 1/2	1	1/2	yes	
202	8	7 3/4	2	1	yes	
203	8	6 3/4	1 1/2	1/2	yes	
204	8	3	2	1/2	yes	
205	6	2	1 1/4	1/4	no	
206	4	4	2	1/4	no	
207	6	2	1 1/2	1/4	no	
208	6	1	1	1/4	no	

## C-2 COIL WELD MAP

Defect Number	Photo Number	Length Inches	Width Inches	Depth Inches	Over 10% Wall Yes/No	Weld Permeability Result
209	26	3 1/2	1 1/2	1	Yes	Acceptable
210	26	1	3/4	1/4	No	1
211	Deleted	—	—	—	—	—
212	26	4	2 1/2	1/4	No	}
213	28	6	2 1/2	3/4	Yes	
214	28	4	2	3/4	Yes	
215	Deleted	—	—	—	—	
216	3	3 1/2	1	3/4	Yes	}
217	28	2	2	1	Yes	
218	28	2	1	3/4	Yes	
219	28	2	1	1/4	No	
220	1 <sup>cut</sup> <sub>flow</sub>	3	1	1	Yes	
221	3	5	4	1/4	No	
222	3	4	1	1/4	No	
223	3	13	4	1/2	Yes	
224	3	2	1	1/4	No	
225	9	9 1/2	7	1/2	Yes	
226	9	3	1 3/4	1/2	Yes	
227	9	1 1/2	1	1/4	No	
228	9	1 1/2	1	1/4	No	
229	4	2 1/2	1	1	Yes	
230	11	6	2	1 1/2	Yes	
231	11	7	1 1/2	3/4	Yes	
232	11	3	1 1/4	3/4	Yes	
233	11	3	1 1/4	3/4	Yes	
234	11	3	2	1/8	No	
235	11	1 1/2	3/4	1/4	No	
236	11	1	3/4	1/8	No	
237	11	2	3/4	1/4	No	
238	11	2	1	1/4	No	
239	11	1 3/4	1	1/4	No	
240	11	8 1/8	3 3/4	1/4	Yes	
241	2	3	1/4	1/8	No	
242	2	1/2	1/2	1/8	No	
243	2	1 1/2	1 1/2	1/4	No	

## C-2 COIL WELD MAP

Defect Number	Photo Number	Length Inches	Width Inches	Depth Inches	Over 10% Wall Yes/No	Weld Permeability Result
244	2	1/2	1/2	1/4	No	Acceptable
245	2	6	1	3/4	Yes	1
246	2	9	2	1/4	Yes	
247	46	8 3/8	3 3/4	1/2	Yes	
248	46	1	1	1/2	No	
249	46	1	1	1/2	No	
250	46	1	1	1/2	No	
251	45	5 1/2	1 1/2	1/8	No	
252	45	2 1/2	2 1/4	1/4	No	
253	45	9	4 1/2	1/2	Yes	
254	46	13	2 1/4	1/2	Yes	
255	46	1	1	1/8	No	
256	46	1	1	1/8	No	
257	46	1 1/2	1	1/8	No	
258	46	1	1/2	1/8	No	
259	46	4	1	1/8	No	
260	46	1 1/2	1	1/4	No	
261	46	6 1/2	5 1/2	1/2	Yes	
262	46	2 1/2	1	1/4	No	
263	46	<del>8</del>	2 3/8	3/4	Yes	
264	46	10	4 1/4	1/2	Yes	
265	46	2 1/2	1 1/2	1/2	No	
266	46	2 1/2	1 1/2	1/2	No	
267	46	2 1/4	1	1/4	No	
268	46	6 1/2	4 1/2	1	Yes	
269	46	6 1/2	3 3/4	3/4	Yes	
270	38	13 1/2	3 3/4	3/4	Yes	
271	38	7	3/4	1/2	No	
272	18	9	2	1/2	No	
273	38	7	2 1/2	1/2	No	
274	38	17	1	3/4	Yes	
275	38	9 3/4	3/4	3/4	Yes	
276	38	4	4	3/4	Yes	
277	40	14	2 1/4	1 1/2	Yes	
278	40	2	1	1/4	No	
279	40	2	1 1/2	1/4	No	
280	40	2 1/4	1 1/2	1/4	No	↓

**C-2 COIL WELD MAP**

<b>Defect Number</b>	<b>Photo Number</b>	<b>Length Inches</b>	<b>Width Inches</b>	<b>Depth Inches</b>	<b>Over 10% Wall Yes/No</b>	<b>Weld Permeability Result</b>	
281	37	6 1/2	3/4	3/4	Yes	Acceptable	
282	37	4	3/4	1/4	NO	↓ ↓ ↓ ↓ ↓ ↓ ↓ ↓ ↓ ↓ ↓ ↓ ↓ ↓ ↓ ↓ ↓ ↓ ↓ ↓	
283	37	1	1/4	1/8	NO		
284	17	3	2	1/8	NO		
285	17	2	1	1/4	NO		
286	17	3	2 1/2	1/4	NO		
287	17	4	2	1/4	NO		
288	17	4	2 1/2	1/4	NO		
289	29	14	5	1/2	NO		
290	29	13	5 1/2	1	Yes		
291	29	1 1/2	1	1/8	NO		
292	29	11 1/2	8 3/8	1	Yes		
293	29	3/4	1/2	1/8	NO		
294	29	5 1/2	4 1/2	3/4	Yes		
295	34	4 1/2	3/4	7/8	Yes		

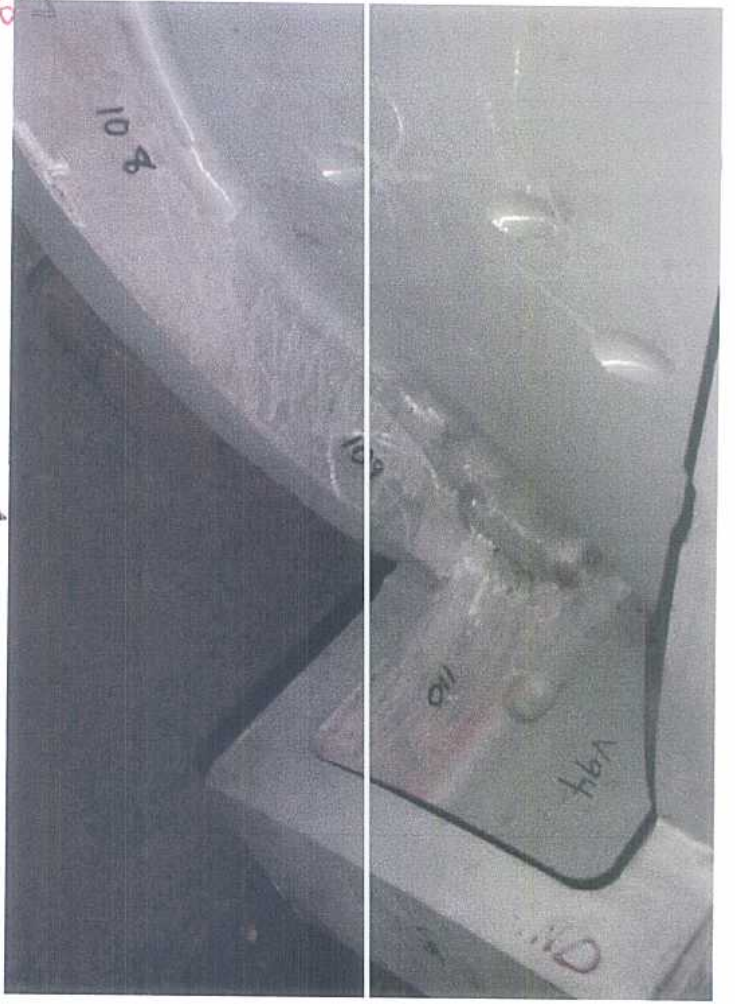

1

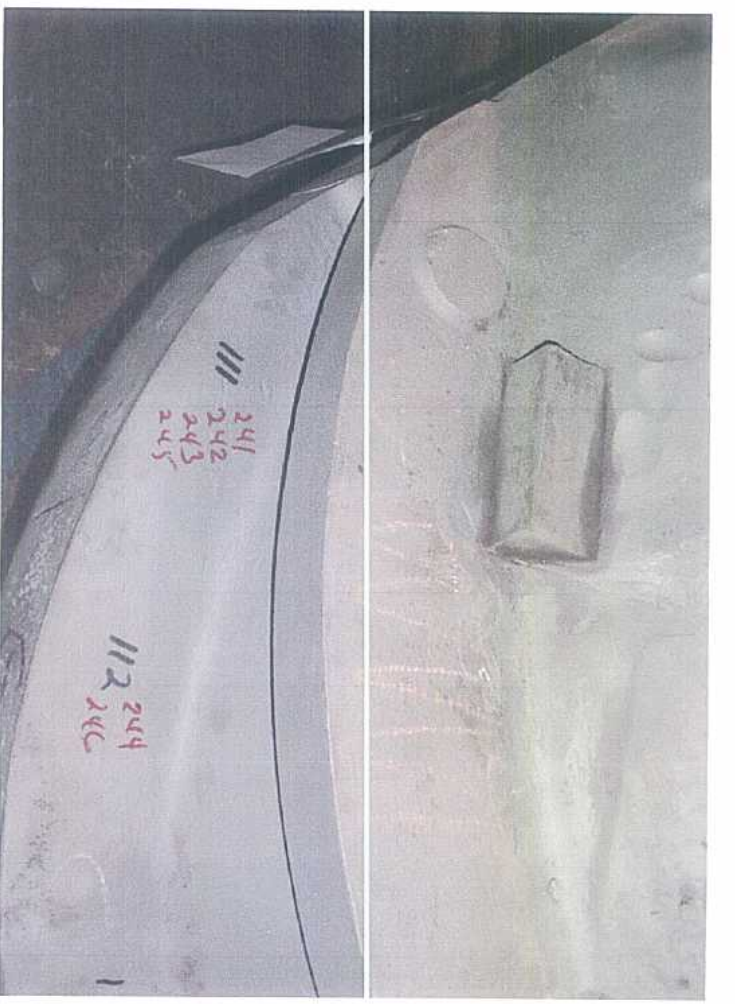

2

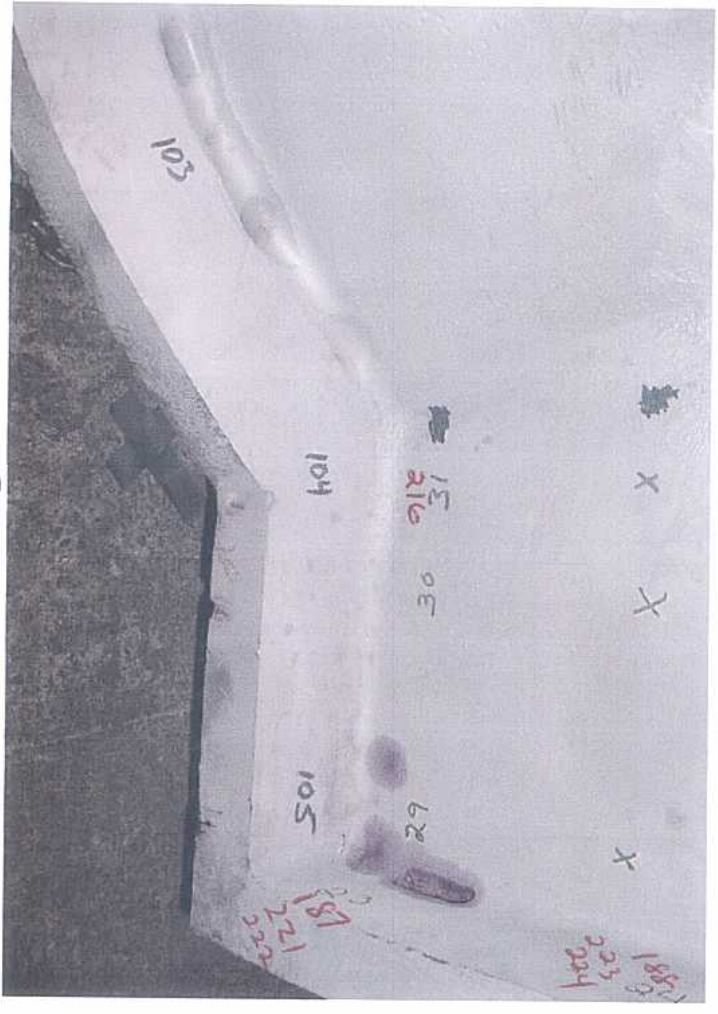

3



4

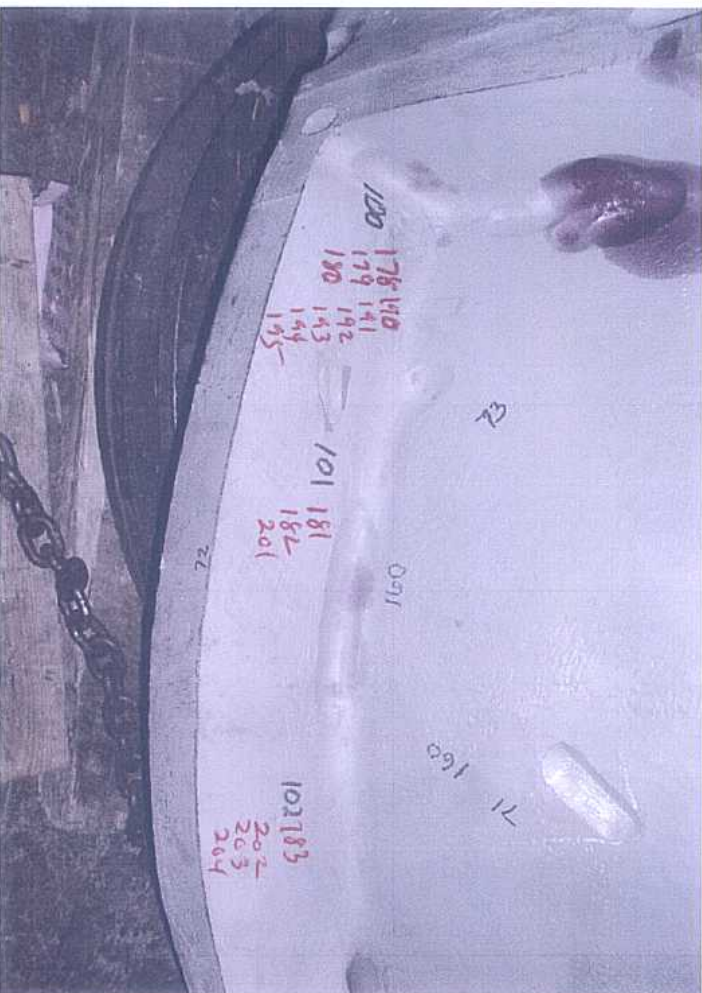
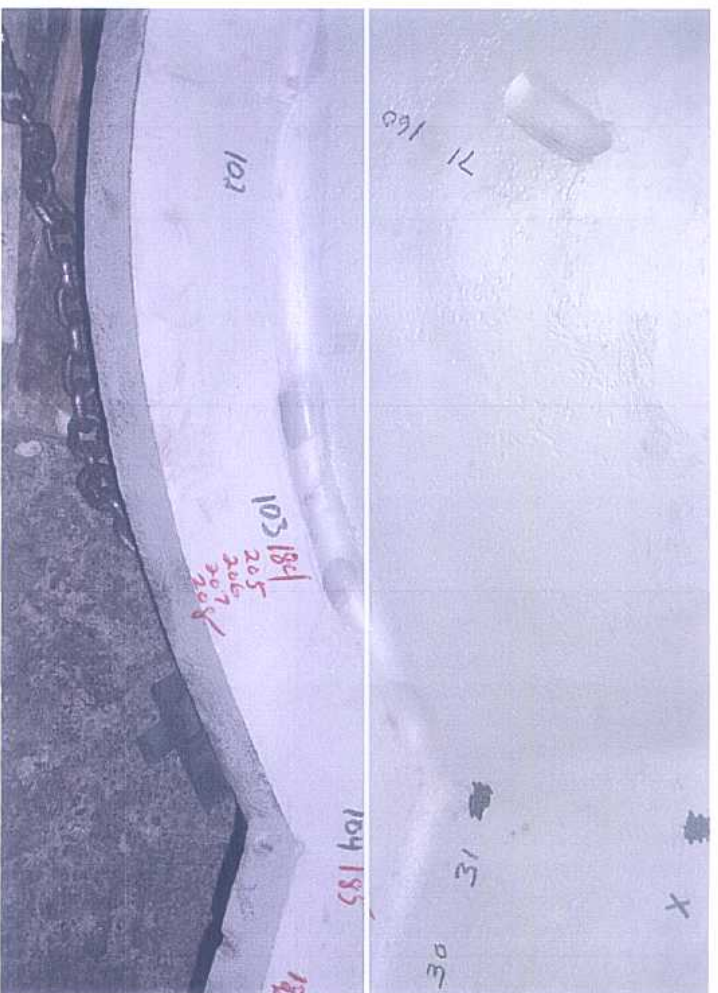
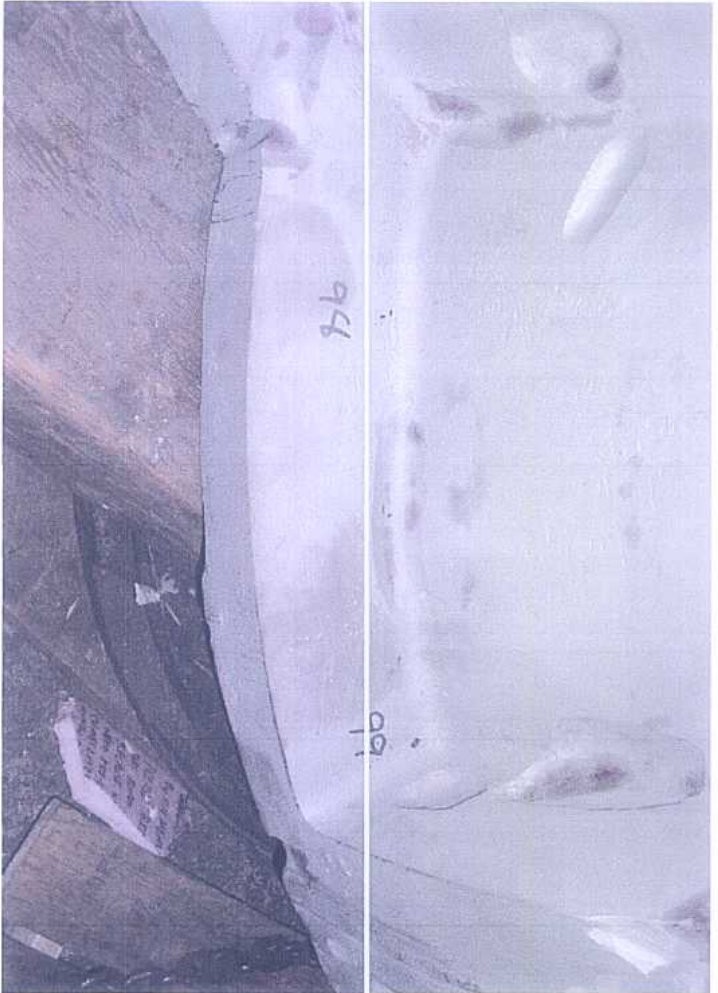

1

8

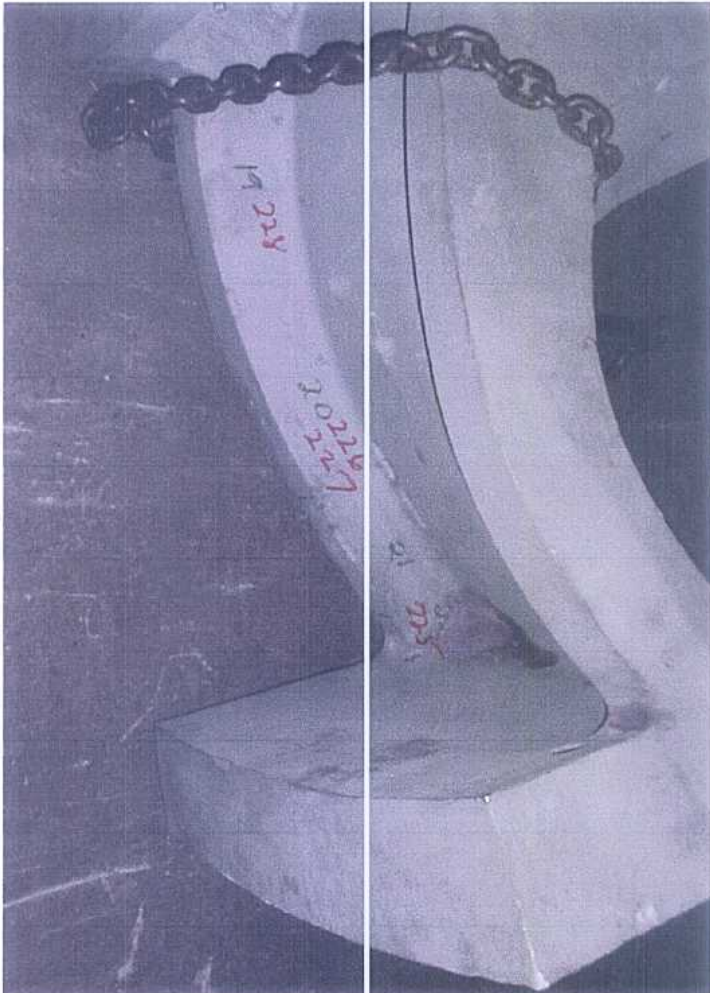

9

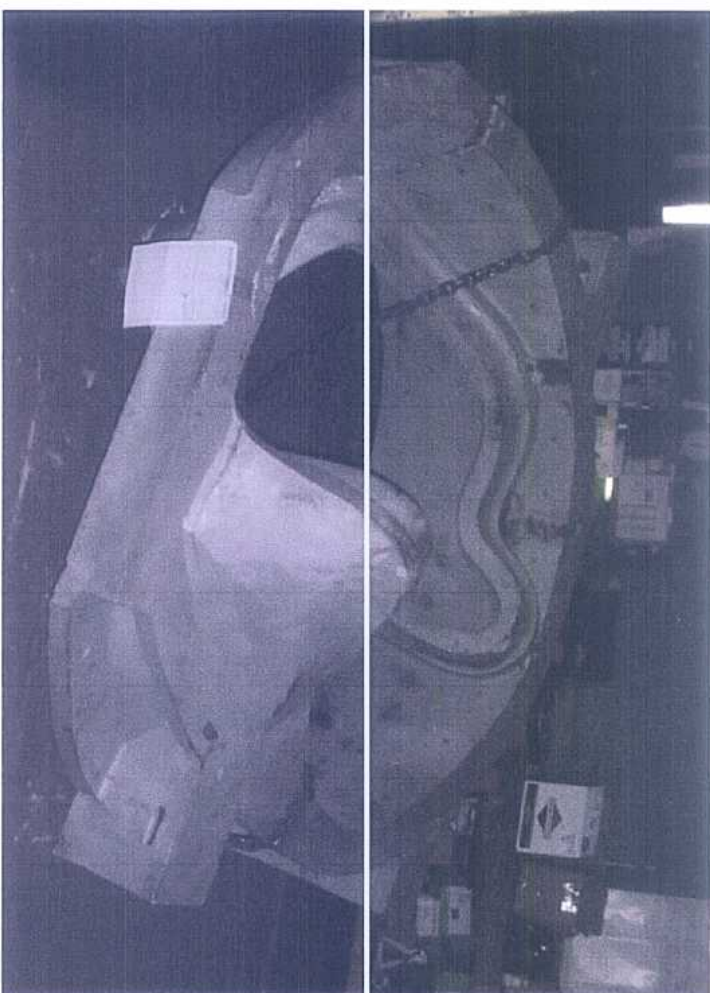

10



11



12





13

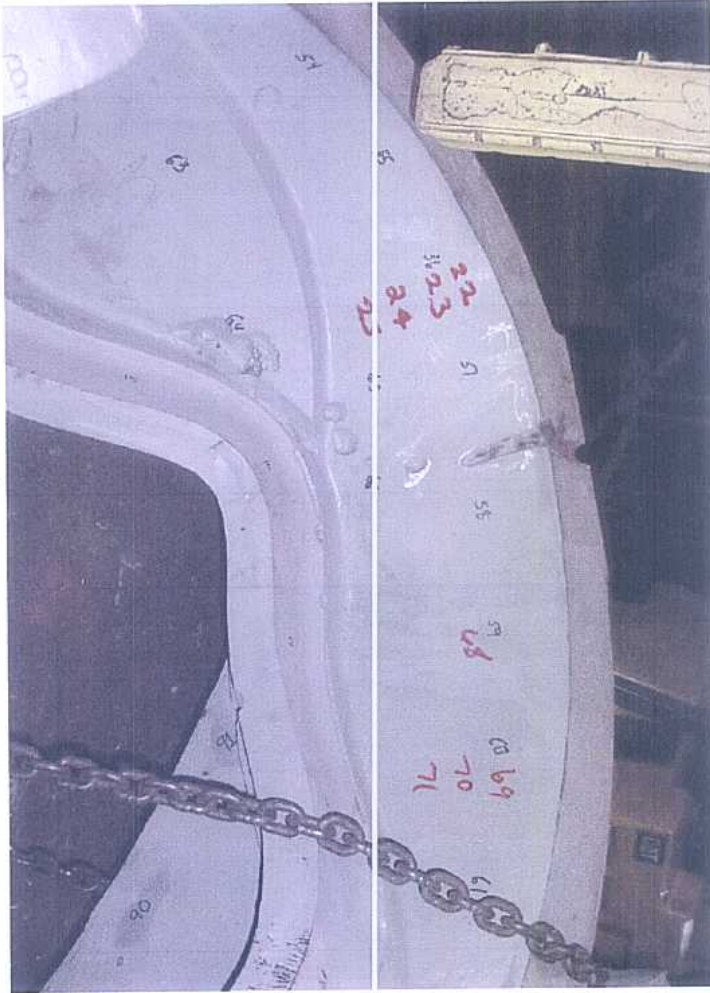

14

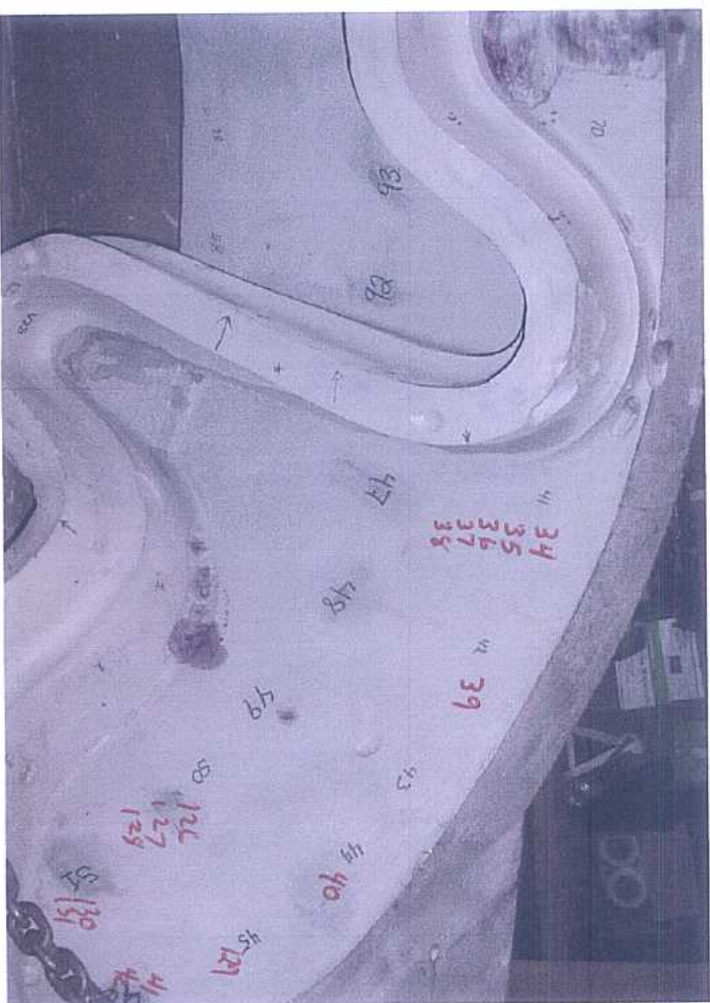

15



16

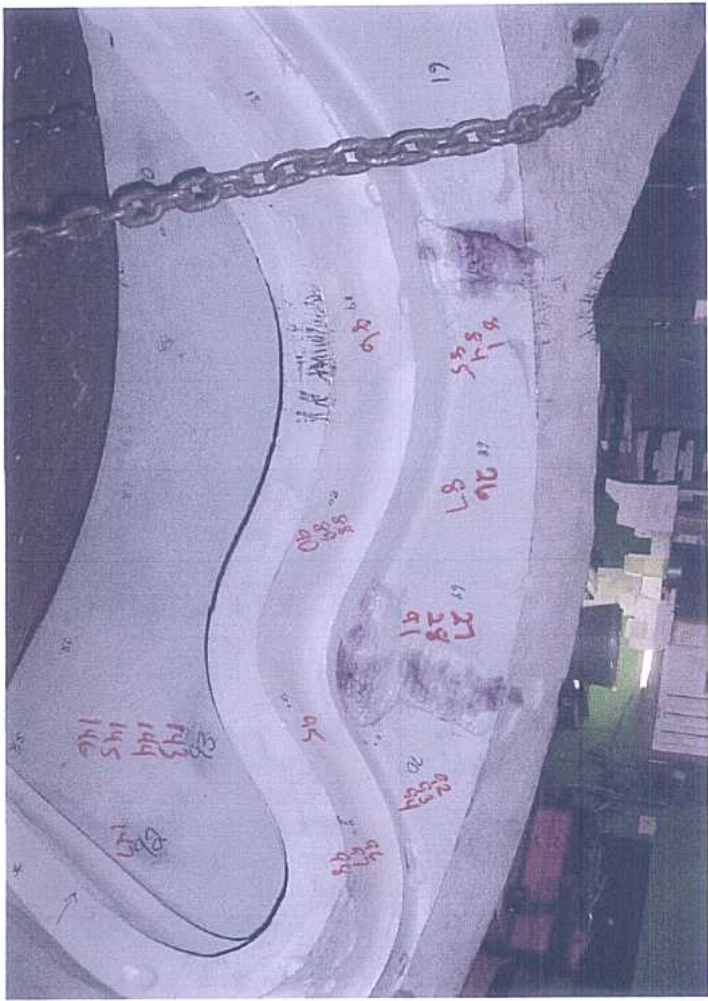

19

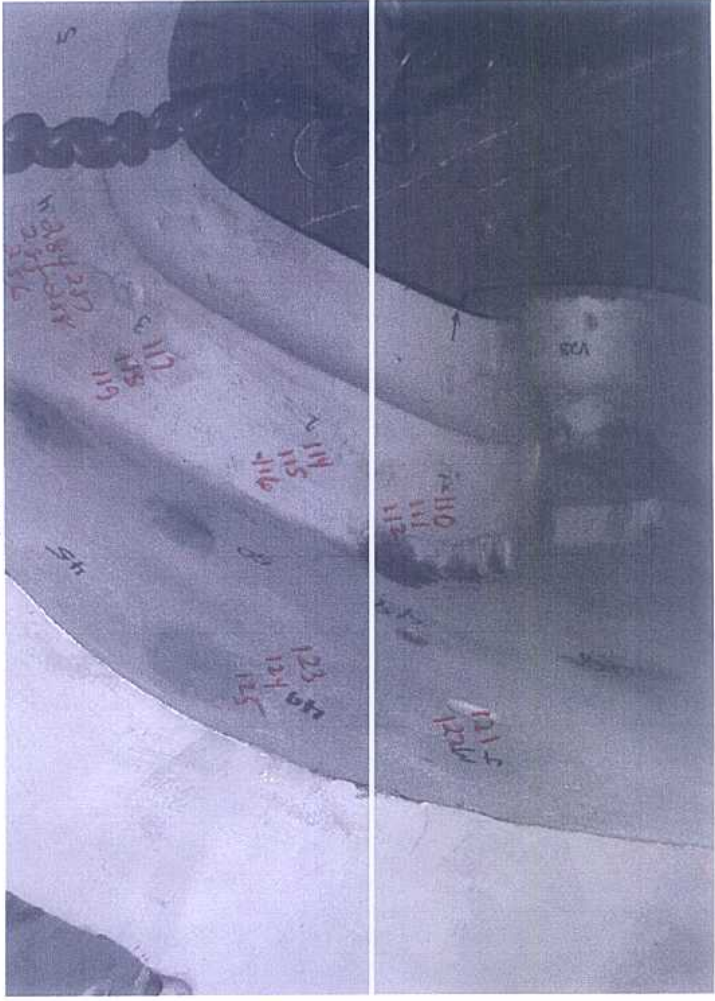

17

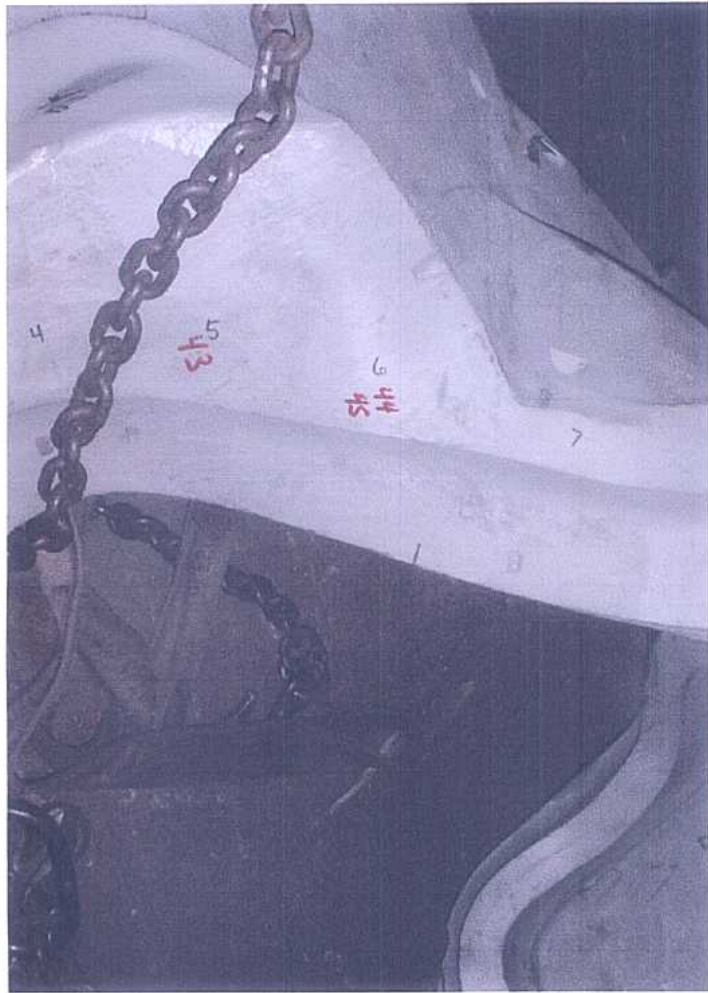

20



18

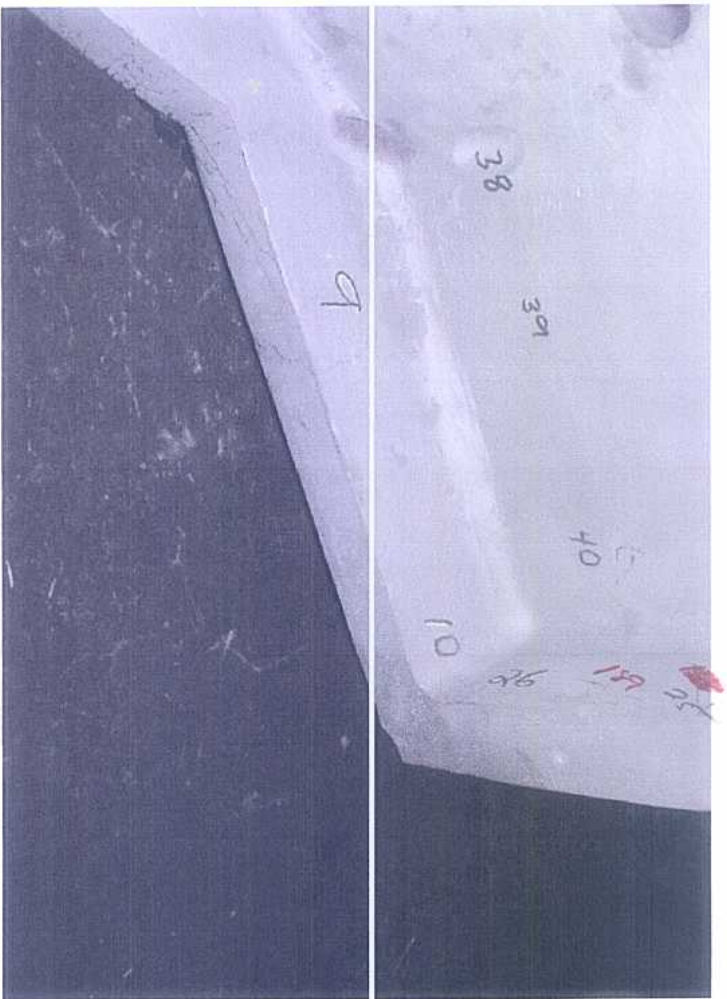

21

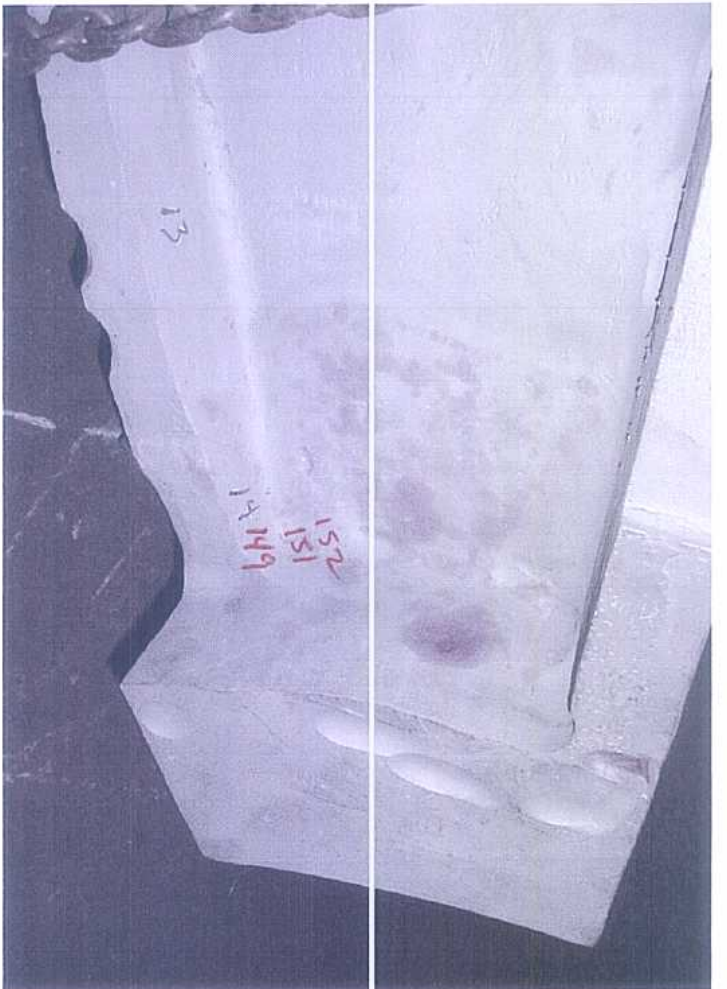

22

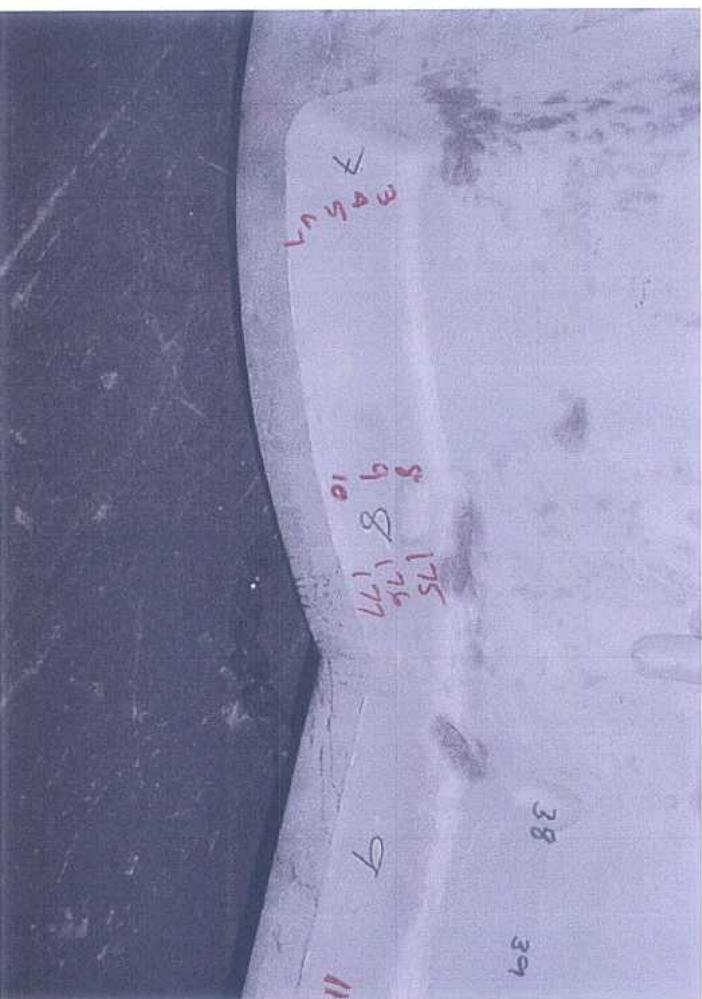

23

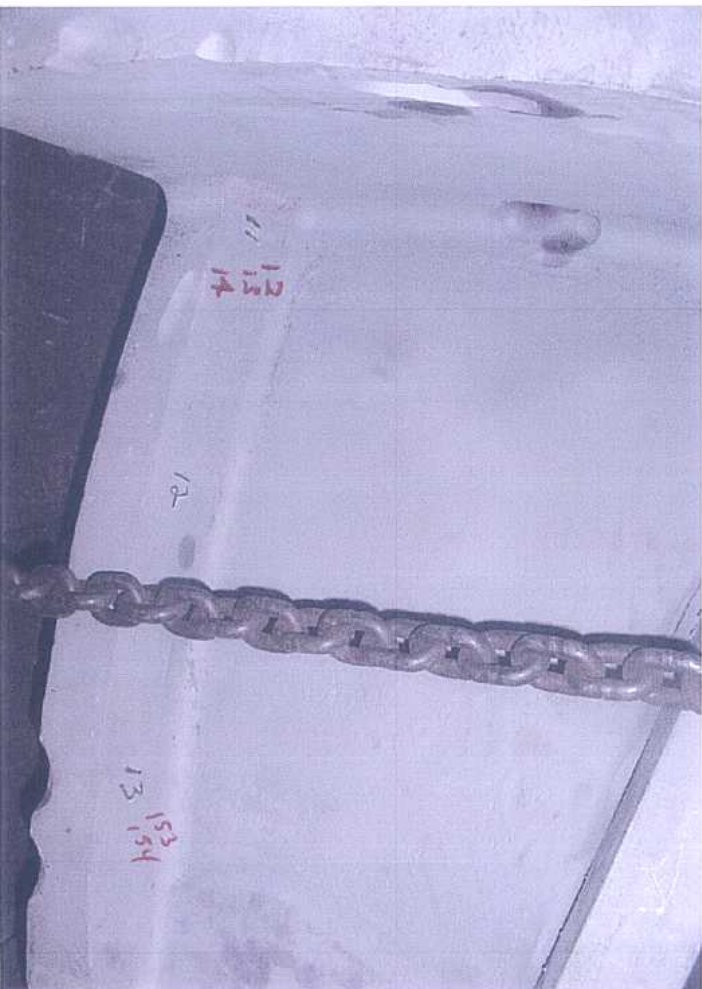

24

27



25

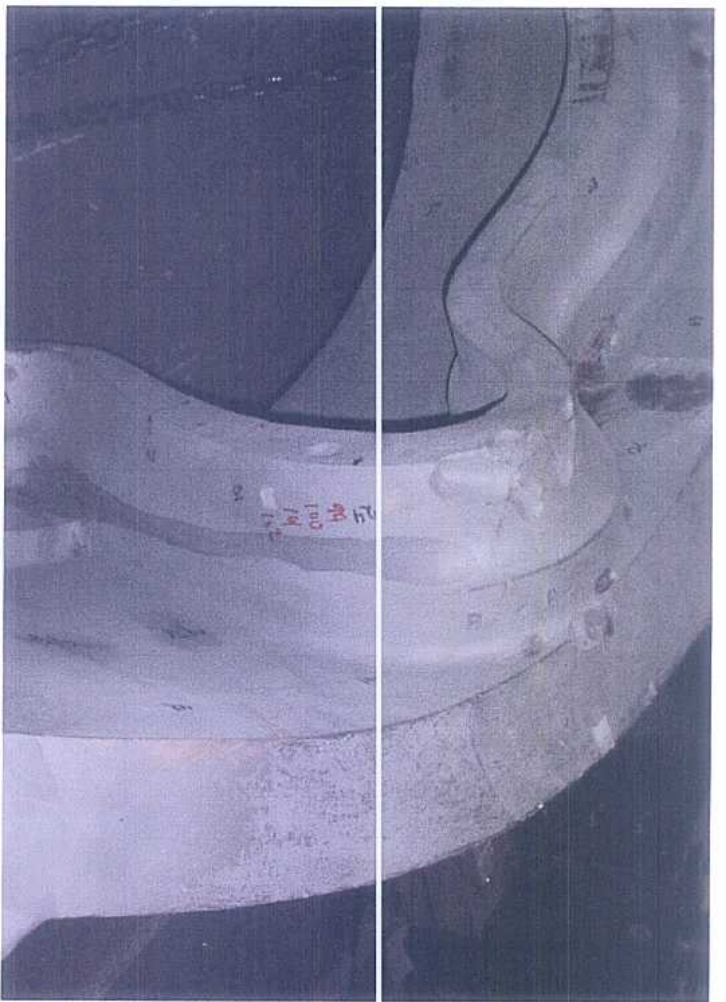

28



26

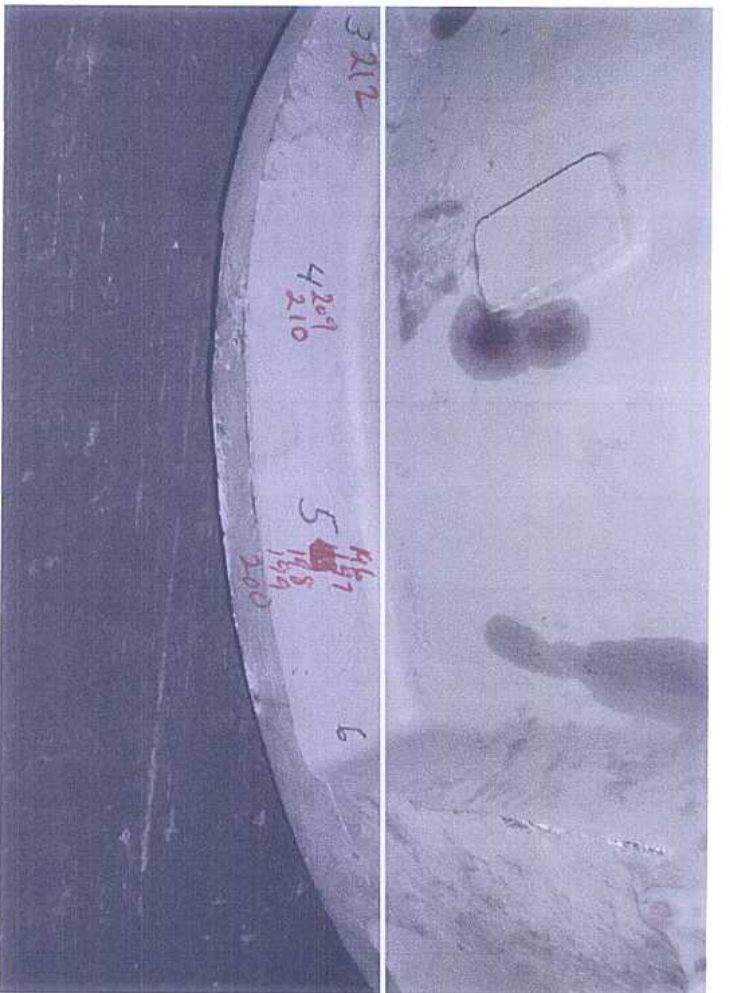



14

C-2 Doc Package  
Document # 14

### Carondelet Division

8600 Commercial Blvd. - Pevely, MO 63070 USA  
Phone: 636-479-4499 - Fax: 636-479-3399

### Final Inspection Report

Customer Name: ENERGY INDUSTRIES OF OHIO

Pattern: MCWF-C2

Order Number: PPPL-FP-LTS-2

Revised 7/26/05

ASTM Metal CF8MNMN MOD

Date 7/26/2005

Type Description	Cert Number	Procedure	Acceptance Criteria	Actual
Liquid Penetrant	S75920-1	CQP - 300 Rev 9	SEE NOTE	Acceptable
<b>Notes</b> Acceptance per ASTM A903. Acceptance criteria - level 1 for high stressed areas, level 2 for all other areas.				
Mag Perm	S75920-1	SOP Mag Perm 100 Rev 1	<1.02	Acceptable
Radiographic	S75920-1	Technique # 12726	MSS SP 54	Acceptable
Visual	S75920-1	CQP - 500 REV 4	ASTM A802 LEVEL 2	Acceptable

Liquid Penetrant

Technician: Jason Rees  
ASNT Level II

Respectfully Submitted,  
Charles A. Ruud  
Quality Assurance Manager

**Superior Quality Engineered Metal Products**

www.MetalTekInt.Com

# TEAM COOPERHEAT-MQS, INC.

## CERTIFIED RADIOGRAPHIC INSPECTION REPORT

FORM 6061-RT- 002 Rev.2

5512 W. State St. Milwaukee, WI 53208 Tel:(414)771-3060 Fax:(414)771-9481 (800)818-6403 www.cooperheat-mqs.com

CUSTOMER		DATE	WORK ORDER NO.
NAME METAL TEK INTERNATIONAL		05/20/2005	361-02283
ADDRESS 8600 COMMERCIAL BLVD		P.O. NUMBER	XRAY X
CITY PEVELY STATE MO ZIP 63070		21041	GAMMA
PROCEDURE SPECIFICATION ASTM E94-93	ACCEPTANCE CRITERIA MSS-SP-54-1999	SHEET ____ OF ____	

PART NUMBER	Serial No	View	No Apparent Indications		Incomplete Penetration		Shrinkage		Film Artifacts		REMARKS
			Acceptable	Rejection	Dross or Slag	Porosity	Lack of Fusion Gas Cracks	Hot Tears	Under cut	Surface	
MCWF -C2	1	1-2	✓		2						
MAIN BODY		2-3	✓								
E.I.O. C040851		3-4	✓				1				
		4-5	✓								
MS75920		5-6	✓								
		7-8	✓								
		8-9	✓								
	9	9-10	✓	ST	R		2			R-2 ✓ 3+	✓
		11-12	✓			2					✓
		12-13	✓								✓
		13-14	✓			1					✓
		14-15	✓								✓
		15-16	✓			1					✓
		16-17	✓			1					✓
		17-18	✓								✓
		18-19	✓								✓
		19-20	✓								✓
		20-21	✓			2					✓
		21-22	✓			1					✓
		23-24	✓			1					✓
		24-25	✓								✓
		26-27	✓				2				✓
		27-28	✓								✓
		29-30	✓			1					✓
		30-31	✓			1					✓

NO. ACCEPTED  NO. REJECTED 1

MQS TECH. NO. 12970 SHT. REV.  
 CUST. RSS NO. SHT. REV.  
 REVIEWER *[Signature]* S. TOWLE  
 CERTIFIED LEVEL (RT) II

C-2 Doc Package  
 Document # 15

# TEAM COOPERHEAT-MQS, INC.

# CERTIFIED RADIOGRAPHIC INSPECTION REPORT

FORM 6061-RT- 002 Rev.2

5512 W. State St. Milwaukee, WI 53208 Tel:(414)771-3060 Fax:(414)771-9481 (800)818-6403 www.cooperheat-mqs.com

**CUSTOMER**

NAME METAL TEK INTERNATIONAL  
 ADDRESS 8600 COMMERCIAL BLVD  
 CITY PEVELY STATE MO ZIP 63070

DATE 05/20/2005

WORK ORDER NO.  
361-02283

P.O. NUMBER  
21041

XRAY X

GAMMA

PROCEDURE SPECIFICATION  
ASTM E94-93

ACCEPTANCE CRITERIA  
MSS-SP-54-1999

SHEET      OF     

PART NUMBER	Serial No	View	No Apparent Indications		Incomplete Penetration		Shrinkage		Film Artifacts		REMARKS
			Acceptable	Rejection	Dross or Slag	Porosity	Lack of Fusion Gas Cracks	Hot Tears	Under cut	Surface	
MCWF -C2	1	32-33	✓		2						
MAIN BODY		33-34	✓							✓	
E.I.O. C040851		35-36	✓		2					✓	
		36-37	✓							✓	
MS75920		38-39	✓							✓	
		39-40	✓		2					✓	
		41-42	✓							✓	
		42-43			R					✓	
		44-45	✓					R		✓	
		45-46			R					✓	
		47-48			R			R		✓	
		48-49			R			R(2)		✓	
		49-50-51	✓		R			R(2)		✓	
		52-53	✓							✓	
		53-54	✓							✓	
		54-55	✓							✓	
		55-56	✓							✓	
		56-57	✓							✓	
		57-58	✓							✓	
		58-59	✓							✓	
		59-60	✓							✓	
		60-61	✓							✓	
		62-63	✓							✓	
		63-64	✓							✓	
		65-66	✓							✓	

NO. ACCEPTED 6

NO. REJECTED 1

MQS TECH. NO. 12970

SHT. REV.

CUST. RSS NO.

SHT. REV.

C-2 Doc Package  
Document # 15

REVIEWER [Signature]  
CERTIFIED NOT LEVEL (RT)

S. TERA LO  
II

# TEAM COOPERHEAT-MQS, INC.

## CERTIFIED RADIOGRAPHIC INSPECTION REPORT

FORM 6061-RT- 002 Rev.2

5512 W. State St. Milwaukee, WI 53208 Tel:(414)771-3060 Fax:(414)771-9481 (800)818-6403 www.cooperheat-mqs.com

**CUSTOMER**

NAME METAL TEK INTERNATIONAL  
 ADDRESS 8600 COMMERCIAL BLVD  
 CITY PEVELY STATE MO ZIP 63070

DATE 05/20/2005

WORK ORDER NO. 361-02283

P.O. NUMBER 21041

XRAY X  
 GAMMA

PROCEDURE SPECIFICATION ASTM E94-93

ACCEPTANCE CRITERIA MSS-SP-54-1999

SHEET        OF       

PART NUMBER	Serial No	View	No Apparent Indications		Dross		Incomplete Penetration		Shrinkage		Film Artifacts		REMARKS
			Acceptable	Rejected	Inclusion	or Porosity	Lack of Fusion	Gas Cracks	Hot Tears	Under cut	Surface		
MCWF -C2	1	67-68	✓										
MAIN BODY		68-69	✓										
E.I.O. C040851		69-70	✓										
		V64	✓										
MS75920		71-72	✓		1								
		72-73	✓										
		73-74	✓										
		74-75	✓										
		75-76	✓										
		76-77	✓										
		78-79	✓		1								
		79-80	✓										
		80-81	✓										
		81-82	✓										
		83-84	✓										
		85-86	✓		2								
		86-87	✓		1								
		87-88	✓	R									
		88-89	✓										
		90-91	✓		1								
		92-93	✓	R									
		V94	✓							2 R			
		V95	✓							1			
		96-97	✓										
		97-98	✓	R						R			

NO. ACCEPTED 6

NO. REJECTED 1

MQS TECH. NO. 12970

SHT.        REV.       

COMMENTS  
 C-2 Doc Package  
 Document # 15

CUST. RSS NO.        SHT.        REV.       

REVIEWER [Signature]  
 CERTIFIED NDT LEVEL (RT) J. TERALB



# TEAM COOPERHEAT-MQS, INC.

# CERTIFIED RADIOGRAPHIC INSPECTION REPORT

FORM 6061-RT- 002 Rev.2

5512 W. State St. Milwaukee, WI 53208 Tel:(414)771-3060 Fax:(414)771-9481 (800)818-6403 www.cooperheat-mqs.com

**CUSTOMER**

NAME METAL TEK INTERNATIONAL  
 ADDRESS 8600 COMMERCIAL BLVD  
 CITY PEVELY STATE MO ZIP 63070

DATE 05/20/2005

WORK ORDER NO.  
361-02283

P.O. NUMBER  
21041

XRAY X  
GAMMA

PROCEDURE SPECIFICATION  
ASTM E94-93

ACCEPTANCE CRITERIA  
MSS-SP-54-1999

SHEET      OF     

PART NUMBER	Serial No	View	No Apparent Indications		Incomplete Penetration		Shrinkage		Film Artifacts		REMARKS
			Acceptable	Rejection	Inclusion or Slag	Porosity	Lack of Fusion Gas Cracks	Hot Tears	Under cut	Surface	
MCWF -C2	1	98-99	✓		R						
MAIN BODY		10-101	✓		R						
E.I.O. C040851		102-102	✓								
		102-103	✓								
MS75920 P		103-104			R						
		104-105			R			R			
		105-107			R			R			
		107-108	✓					R			
		108-109	✓								
		109-110	✓								
		111-112	✓		1						
		112-113	✓			2					
		114-115	✓								
		115-116	✓					2			
		116-117			R			R			

NO. ACCEPTED 11 NO. REJECTED 1

MQS TECH. NO. 12970

SHT.      REV.     

CUST. RSS NO.     

SHT.      REV.     

REVIEWER [Signature]  
 CERTIFIED LEVEL (RT)

C-2 Doc Package  
Document # 15

# TEAM COOPERHEAT-MQS, INC.

## CERTIFIED RADIOGRAPHIC INSPECTION REPORT

FORM 6061-RT- 002 Rev.2

5512 W. State St. Milwaukee, WI 53208 Tel:(414)771-3060 Fax:(414)771-9481 (800)818-6403 www.cooperheat-mqs.com

**CUSTOMER**

NAME METAL TEK INTERNATIONAL  
 ADDRESS 8600 COMMERCIAL BLVD  
 CITY PEVELY STATE MO ZIP 63070

DATE 05/20/2005

WORK ORDER NO.  
361-02283

P.O. NUMBER  
21041

XRAY X

GAMMA

PROCEDURE SPECIFICATION  
ASTM E94-93

ACCEPTANCE CRITERIA  
MSS-SP-54-1999

SHEET \_\_\_\_\_ OF \_\_\_\_\_

PART NUMBER	Serial No	View	No Apparent Indications		Dross		Incomplete Penetration		Shrinkage			Film Artifacts		REMARKS
			Acceptable	Rejection	Inclusion	Porosity	Lack of Fusion	Gas	Cracks	Hot Tears	Under cut	Surface		
MCWF -C2	1	1-2	✓				1						✓	
INSIDE RAIL		2-3	✓				1						✓	
E.I.O. C040851		3-4	✓				1						✓	
		4-5	✓				1						✓	
MS75920		5-6	✓										✓	
		6-7	✓										✓	
		7-8	✓										✓	
		8-9	✓										✓	
		9-10	✓										✓	
		10-11	✓										✓	
		11-12	✓										✓	
		12-13	✓		1								✓	
		13-14	✓										✓	
		14-15	✓				1						✓	
		15-16	✓										✓	
		16-17	✓		1		2-3						✓	
		17-18	✓				1						✓	
		18-19	✓										✓	
		19-20	✓		2								✓	
		20-21	✓										✓	
		21-22	✓						1-2				✓	
		22-23	✓						1				✓	
		23-24	✓										✓	
		24-25	✓										✓	
		25-26	✓										✓	

NO. ACCEPTED 1 NO. REJECTED 0

MQS TECH. NO. 12970 SHT. REV.

CUST. RSS NO. REV.

C-2 Doc Package  
Document # 15

REVIEWER S. TERRELL  
CERTIFIED NOT LEVEL (RT)

# TEAM COOPERHEAT-MQS, INC.

## CERTIFIED RADIOGRAPHIC INSPECTION REPORT

FORM 6061-RT- 002 Rev.2

5512 W. State St. Milwaukee, WI 53208 Tel:(414)771-3060 Fax:(414)771-9481 (800)818-6403 www.cooperheat-mqs.com

### CUSTOMER

NAME METAL TEK INTERNATIONAL  
 ADDRESS 8600 COMMERCIAL BLVD  
 CITY PEVELY STATE MO ZIP 63070

DATE  
05/20/2005

WORK ORDER NO.  
361-02283

P.O. NUMBER  
21041

XRAY X

GAMMA

PROCEDURE SPECIFICATION  
ASTM E94-93

ACCEPTANCE CRITERIA  
MSS-SP-54-1999

SHEET \_\_\_\_\_ OF \_\_\_\_\_

PART NUMBER	Serial No	View	No Apparent Indications		Dross or Porosity			Incomplete Penetration		Shrinkage		Film Artifacts			REMARKS
			Acceptable	Rejected	Inclusion	or Porosity	Lack of Fusion	Gas Cracks	Hot Tears	Under cut	Surface				
MCWF -C2	1	26-27	✓		1										
INSIDE RAIL		V28	✓												
E.I.O. C040851		29-30	✓		1										
		30-1	✓												
MS75920															

NO. ACCEPTED 1 NO. REJECTED 0 MQS TECH. NO. 12970 SHT. REV.

COMMENTS C-2 Doc Package Document # 15 CUST. RSS NO. REVIEWER S. TONALIS CERTIFIED NDT LEVEL (RT)

C-2 Doc Package  
Document # 15

REVIEWER S. TONALIS  
CERTIFIED NDT LEVEL (RT)

# TEAM COOPERHEAT-MQS, INC.

## CERTIFIED RADIOGRAPHIC INSPECTION REPORT

FORM 6061-RT- 002 Rev.2

5512 W. State St. Milwaukee, WI 53208 Tel:(414)771-3060 Fax:(414)771-9481 (800)818-6403 www.cooperheat-mqs.com

**CUSTOMER**

NAME METAL TEK INTERNATIONAL  
 ADDRESS 8600 COMMERCIAL BLVD  
 CITY PEVELY STATE MO ZIP 63070

DATE 06/11/2005

WORK ORDER NO.  
361-02341

P.O. NUMBER  
21041

XRAY X  
GAMMA

PROCEDURE SPECIFICATION  
ASTM E94-93

ACCEPTANCE CRITERIA  
MSS-SP-54-1999

SHEET 1 OF 1

PART NUMBER	Serial No	View	No Apparent Indications		Dross or Porosity		Incomplete Penetration		Shrinkage		Film Artifacts		REMARKS
			Acceptable	Rejected	Included	or	Lack of Fusion	Gas Cracks	Hot Tears	Under cut	Surface		
MCWF -C2	1	9-10	✓		2				1				
		41-42	✓		1							✓	
E.I.O. C040851		45-46	✓		1					2			
		47-48	✓		1					1			
MS75920		48-49	✓										
(R1)		87-88	✓									✓	
		92-93		R			R					✓	
		97-98	✓						1				
		103-104	✓										
		104-105	✓										
		106-107	✓		1								
		116-117	✓		1								

NO. ACCEPTED 0 NO. REJECTED 1 MQS TECH. NO. 12970 SHT. REV.  
 COMMENTS C-2 Doc Package Document # 15 CUST. RSS NO. REVIEWER John Petroske CERTIFIED NOT LEVEL (RT) John Petroske RT II Exp. 01/08

**RADIOGRAPHIC INTERPRETATION REPORT**

CUSTOMER <i>Energy Industries of Ohio</i>		PURCHASE ORDER NUMBER <i>PPAL-F2LTS-2</i>				DATE <i>6-15-05</i>		CONTROL NO. <i>40851</i>		PAGE <i>1 of 1</i>	
PART NO. <i>MCWF-C2</i>		SPECIFICATION <i>E446</i>			CLASS <i>See Spec</i>			TOTAL PIECES <i>1</i>		PIECES ACCEPTED <i>1</i>	
RADIOGRAPHED BY: <i>M. J. St...</i>				INTERPRETED BY: <i>M. J. St...</i>				ASNT LEVEL <i>II</i>			
FILM TYPE <i>29/59</i>		MATERIAL <i>CF8M/NIN</i>			ISOTOPE <i>IRIDIUM 192 COBALT 60 V</i>				CODE <i>ASTM E94 V ASME MIL-STD-453</i>		
VIEW		PENE	ACCEPT	REJECT	SHRINK	INCLUSION	POROSITY	LINEAR	SURFACE	LOF/LOP	COMMENTS
<i>MS 75920</i>											
		<i>92-9382</i>	<i>30/40</i>		<i>X</i>					<i>X</i>	
<i>6-16-05</i>		<i>92-9383</i>	<i>30/40</i>	<i>/</i>		<i>1</i>	<i>2</i>	<i>/</i>			<i>Film Crimp</i>

C-2 Doc Package  
Document # 17

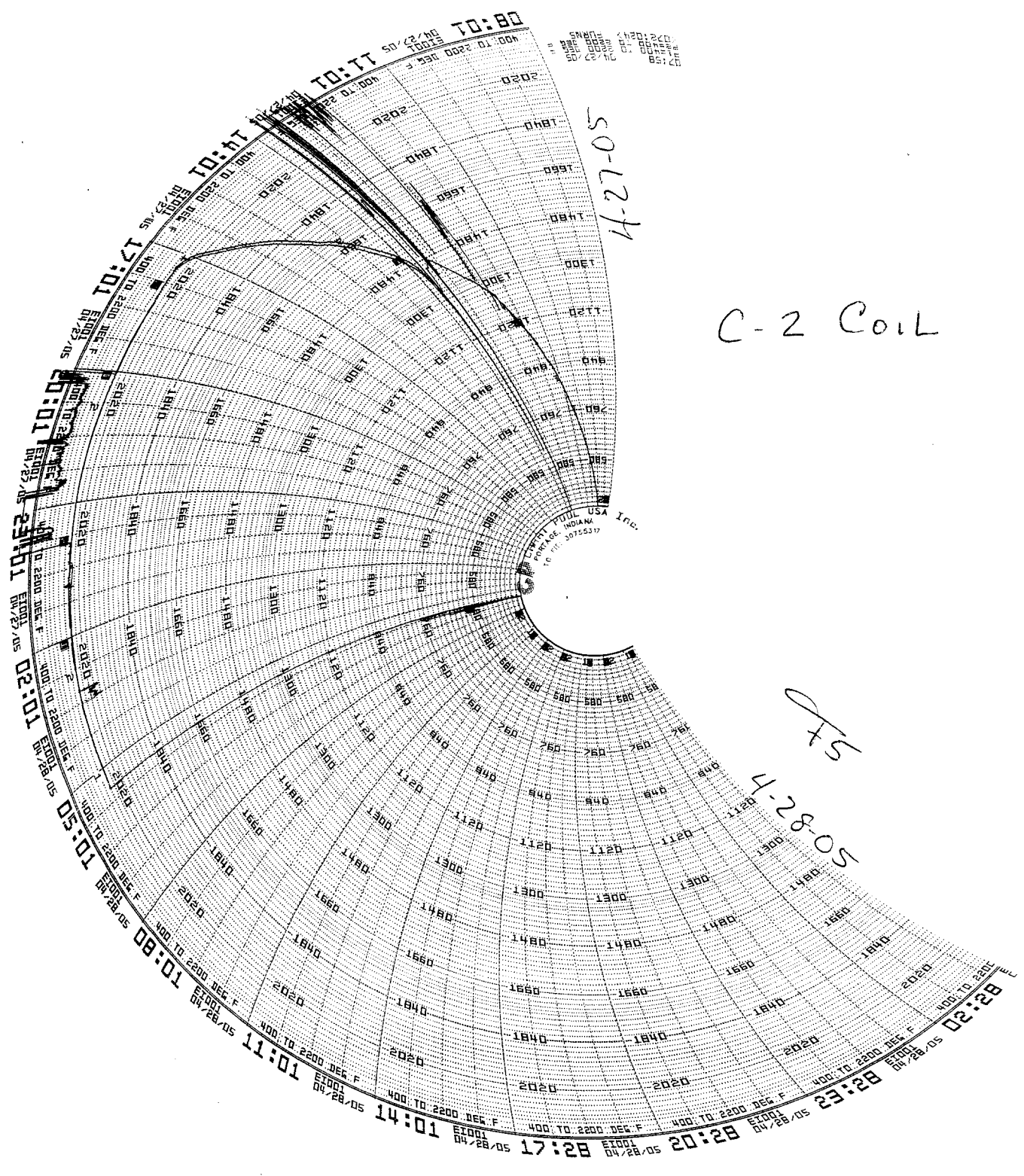

C-2 Coil  
5 Pass  
Relief  
6/21/05

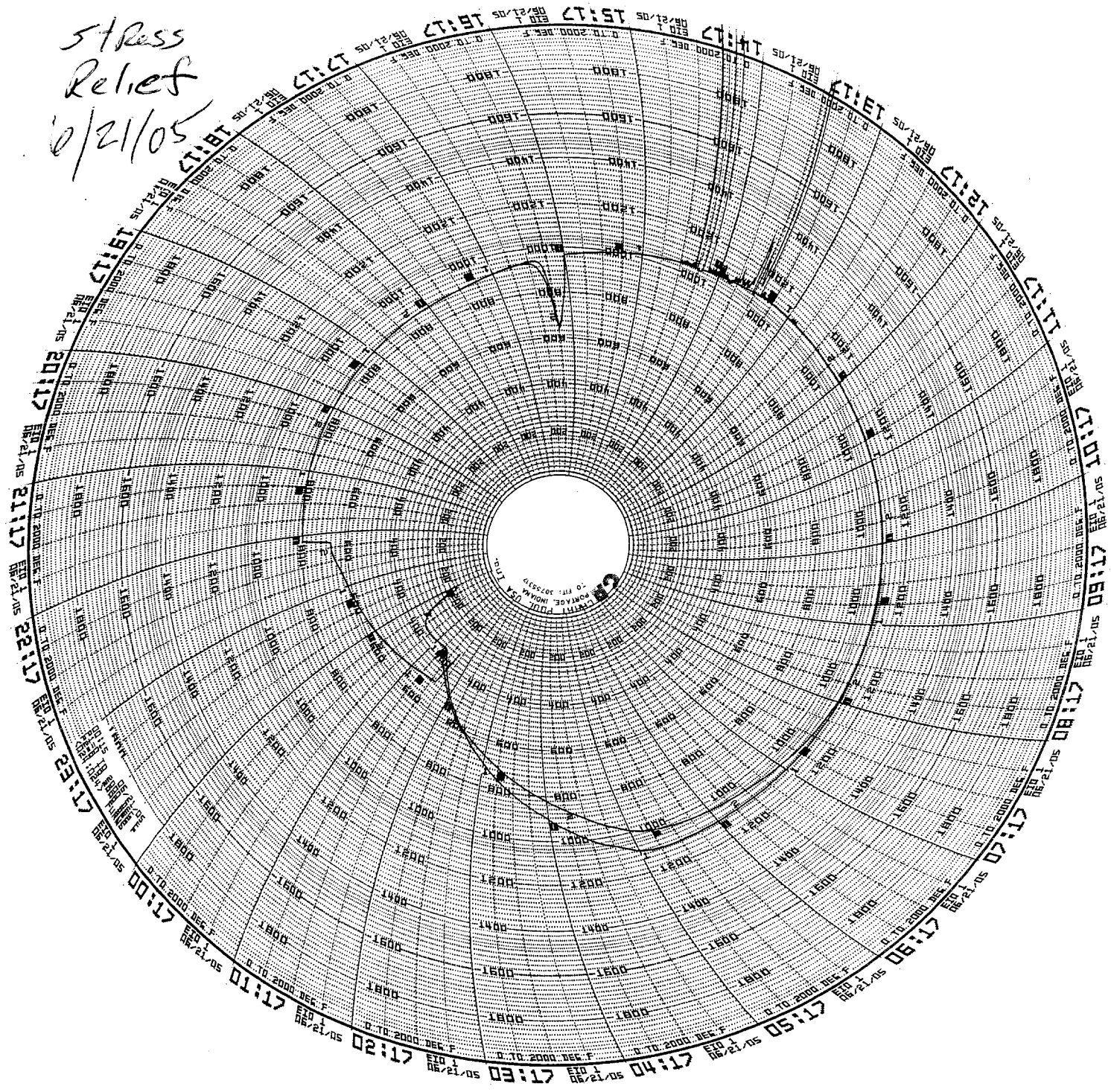



C-2 Doc  
Package  
Document # 19

Corrective Action 1292  
Carondelet Division - CA / PA / RGA Database  
Corrective Action Type NCR  
Date 6/1/2005 6-2-05 Rev *I chr*  
CA Originator C. Ruud  
Pattern Number: C-2 Coil

**Description of Defect / Non-Conformance**

104 defects requiring major welds were found during visual, LP and RT inspections.

**Root Cause**

Inherent to the manufacturing process.

**Corrective Action** Weld upgrade C1 casting. Welding will be performed following the approved procedure FOR WELDS <2" - WPS 10-SMAW-CF8MNMN MOD REV 1. FOR WELDS <8" - WPS 15-GMAW-CF8MNMN MOD REV 2.

**Verification of Corrective Action**

All repairs will be verified by the inspection method used to discover the original defect.

A handwritten signature in black ink, appearing to read "C. Ruud".

Signed: C. Ruud

CC: Roger Broman, Barry Craig, Joe Edwards, E.J. Kubick





Corrective Action 1292a  
Carondelet Division - CA / PA / RGA Database  
Corrective Action Type NCR  
Date 6/15/2005  
CA Originator C. Ruud  
Pattern Number: C -2 Coil

C-2 Doc Package  
Document # 20

**Description of Defect / Non-Conformance**

Defect found during RT verification. Result in a major weld.

**Root Cause**

Lack of fusion was discovered.

**Corrective Action**

Weld repair will be made according to approved procedures.

**Verification of Corrective Action**

Area will be LP and RT inspected.

**Estimated Completion Date**

6/15/05

**Actual Completion Date**

Complete.

A handwritten signature in black ink, appearing to read "C. Ruud".

Signed: C. Ruud

CC: Roger Broman, Barry Craig, Joe Edwards, E.J. Kubick

We concur with this CA.

**Nonconformance Report:** MetalTek CA 1292 Rev. 1

**Project Disposition:** Corrective action approved

**Approvals**

Procurement Technical Representative \_\_\_\_\_  
Wayne Reiersen for Phil Heitzenroeder

Responsible Line Manager \_\_\_\_\_  
Mike Cole for Brad Nelson



Corrective Action 1302  
Carondelet Division - CA / PA / RGA Database  
Corrective Action Type NCR  
Date 5/29/2005  
CA Originator C. Ruud  
Pattern Number: C-2 Coil

C-2 Doc Package  
Document # 21

**Description of Defect / Non-Conformance**

Failed to differentiate two directions of test material on pattern/casting per the requirement of NCSX-CSPEC-141-03-07, SECTION 4.2.2.

**Root Cause**

Failed to communicate specification to Pattern Shop to add cast on test material specimens in the transverse direction.

**Corrective Action**

Will request a deviation to eliminate requirement.

**Verification of Corrective Action**

N/A

**Preventive Action**

Create Inspection and Test Plan summarizing all requirements.

**Estimated Completion Date**

6/15/05

**Actual Completion Date**

Signed: C. Ruud

CC: Roger Broman, Barry Craig, Joe Edwards, E.J. Kubick

Accept As-Is. NCSX-CSPEC-141-03-07  
is being revised to eliminate the requirement  
to test in 2 directions. 6-6-05 pta  
Ref. also 1301.

Corrective Action 1323  
Carondelet Division - CA / PA / RGA Database  
Corrective Action Type NCR  
Date 7/27/2005  
CA Originator C. Ruud  
Applies to: Coil castings C-1, C-2, C-3, C-4 and A-1 and C 1 shim and four C coil and six A coil shims

### Description of Defect / Non-Conformance

Phosphorus levels in material produced to date exceed specification limits. Both phosphorus and sulfur readings reported erroneously in certifications.

Certification reports have shown phosphorus and sulfur levels in the <.01% range. Independent laboratory data confirmed phosphorus in the .018 to .033% range and sulfur in the .005 to .022% range. Actual levels of some tests are above those in PPPL Specification NCSX-CSPEC-141-03-07 Rev 7.

Nonconformance was first suspected as a result of analysis of zoned attached test specimens volunteered by MetalTek International as response to PPPL questions on weighted average chemical analysis and quality of blending in the gating system. Nonconformance was verified on the bars used in the study and has been extended to evaluation of previously poured products.

### Root Cause

Specification limits were set below the levels achievable through use of available raw materials. Spectrometer did not properly calibrate for phosphorus and sulfur at levels of specification due to equipment malfunction.

The chemical specification of EIO heats uses alloy CF8MNMn-Mod which incorporates a type standard calibration with a certified reference material (CRM) BS180. This enables the operator of the spectrometer to match the elemental concentrations of this alloy with corrective factors. These factors are determined by analyzing the CRM and having them compared with the calibration curves for each element. The phosphorus and sulfur content have very low measured intensities due to low concentrations. Intermittent failure of the spectrometer intensity measuring card caused higher intensity readings for phosphorus and sulfur. Subsequent checks with the CRM resulted in low corrective factors that were not detected. This in turn resulted in low reported concentrations for the EIO samples. All the major elements, which are measured on other intensity cards, have been closely monitored and matched very well with the CRM and thus were reported correctly.

### Corrective Action

Modification to specification for phosphorus and sulfur will be requested. Limits will be set based on process capability and consistent with other stainless steel grades. Replacement of deficient card in spectrometer will be made upon delivery.

Subsequent immediate analysis of chemistry results, obtained by wet analysis, is attached and demonstrate top of specification for sulfur and over specification for phosphorus. The spectrometer manufacturer has performed an analysis to determine the cause of the malfunction and verified that the intensity card has an intermittent fault and must be replaced. The card has been ordered and scheduled for replacement on August 15, 2005.

Until the card is replaced we will be performing additional type standardizations to ensure accurate sulfur and phosphorus analysis. Additionally, for coils made until the card is replaced, an independent laboratory will perform a verification of the chemical analysis.

**Verification of Corrective Action**

Will be determined at a later date.

**Preventive Action**

In addition to spectrometer faults, we have identified that the specification ranges for sulfur and phosphorus is unattainable. Analysis and specifications for virgin charge materials predict sulfur at 0.040% maximum and phosphorus at 0.040% maximum. We have no way to remove phosphorus from the melt and do not intentionally add phosphorus. So, the confirmed coil analyses, along with analyses of virgin material heats, demonstrate sulfur in the range of 0.010% to 0.022% and phosphorus in the range of 0.018% to 0.033%. These results are consistent with our charge material analysis. We will request a deviation for phosphorus in the subject parts and also request a permanent specification change to 0.040% maximum for both phosphorus and sulfur, to allow us to provide non-discrepant material. This change will not affect, in any way, the physical properties or material performance because all coils and test material exhibited sulfur and phosphorus within the new ranges despite inaccurate reporting. Other actions: Specifications have been added to the BS 180 standard and the type standard will be measured against the criteria.

**Estimated Completion Date**

August 15, 2005

**Actual Completion Date TBD**

Signed: C. Ruud



CC: Jim Galaske, Barry Craig, Joe Edwards, E.J. Kubick

**Guide to St Louis Testing Report Dated 7-26-05**

Sample name	Sample origin
A1Z1	Cast on bar A-1 coil, zone 1
A1Z2	Cast on bar A-1 coil, zone 2
A1Z3	Cast on bar A-1 coil, zone 3
C1	Cast on bar C-1 coil
C2Z1	Cast on bar C-2 coil, zone 1
C2Z2	Cast on bar C-2 coil, zone 2
C2Z3	Cast on bar C-2 coil, zone 3
C3Z1	Cast on bar C-3 coil, zone 1
C3Z2	Cast on bar C-3 coil, zone 2
C3Z3	Cast on bar C-3 coil, zone 3
F1	Final analysis button from ladle for C-4 coil
F2	Final analysis button from ladle for C-4 coil
F3	Final analysis button from ladle for C-4 coil
P1	Preliminary analysis button from ladle for C-4 coil

Testing is underway of the heat used to pour the four C coil and six A coil shims.

C-2 Doc Package  
Document # 21a

Founded 1929

**St. Louis Testing Laboratories**  
INCORPORATED



Attachment to  
CA 1323

Chemical, Metallurgical, Mechanical, Nondestructive, Environmental Testing, Analyses and Field Service.

July 26, 2005  
Lab No. 05C-0608  
Invoice No. 59891  
P.O. No. 21324  
Page 1 of 1

**METALTEK INTERNATIONAL**  
8600 Commercial Blvd.  
Pevely, MO 63070

**Attention: Chuck Ruud**

**REPORT OF CHEMICAL ANALYSIS**

**SAMPLE ID:** A1 Z1, A1 Z2, A1 Z3, C1, C2 Z1, C2 Z2, C2 Z3,  
C3 Z1, C3 Z2, C3 Z3, F1, F2, F3, P1

**RESULTS: %**

ANALYTE	A1Z1	A1Z2	A1Z3
Sulfur	.013	.005	.010
Phosphorus	.025	.023	.018

ANALYTE	C1	C2Z1	C2Z2	C2Z3
Sulfur	.014	.022	.018	.015
Phosphorus	.018	.024	.021	.025

ANALYTE	C3Z1	C3Z2	C3Z3
Sulfur	.013	.014	.012
Phosphorus	.024	.025	.021

ANALYTE	F1	F2	F3	P1
Sulfur	.014	.015	.012	.010
Phosphorus	.029	.033	.028	.030

Sulfur Test Method: ASTM E1019-03

Phosphorous Test Method: Colormetric

Identification of tested specimen provided by the client.

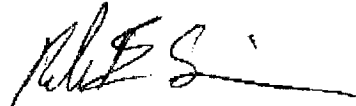
  
Robin E. Sinn  
Laboratory Director

RES/nmc

MEMBER  
**ACIL**

2810 Clark Avenue • St. Louis, MO 63103-2574 • (314) 531-8080 • FAX (314) 531-8085



Addendum to CA1323 8-17-05

Historical:

The proto type coil was poured on February 24, 2004. The chemistry specification at that time permitted a maximum of 0.04% for sulfur and phosphorus. The reported values for these elements were 0.01 and 0.02% respectively.

Prior to pouring the C-1 coil casting the specification was revised. MT failed to incorporate the revisions into our system. The contract review procedure did not detect the changes to the specification. Therefore normal change procedures were not implemented. This was reported in corrective action 1308 on June 13, 2005. The error was recognized when the material poured to cast C and A coil shims did not meet the revised specification.

An investigation was begun immediately to determine compliance of the C-1 and C-2 coils. It was determined that both the C-1 and C-2 met the revised chemistry, except for sulfur and phosphorus. To verify the analysis MT analyzed samples from the cast on bars taken from the coils. By this time the optical card had malfunctioned. This fact, in combination with the human error (believing that the type standard was also in the 0.002% range) led MT to believe that the sulfur and phosphorus were actually in the 0.002% range. As a result MT believed the coils to be compliant and no action was taken.

Current Activities:

Samples from A-1, C-4 and C-5 have been sent to Wisconsin Centrifugal, our parent company for independent analysis of all reported elements.

Repair to the spectrometer is scheduled for this week. In the mean time we continue our surveillance of the suspect elements during melt and chemistry analysis.

C. Ruud

A handwritten signature in black ink, appearing to read "C. Ruud", written over a horizontal line.

CC: Jim Galaske, Barry Craig, Joe Edwards, E.J. Kubick





Corrective Action  
Carondelet Division - CA / PA / RGA Database  
Corrective Action Type NCR  
Date 10/20/2005 Revised 10-25-05  
CA Originator C. Ruud

1423

C-2 Doc Package  
Document # 21b

Applies to: Weld Material Metrode Lot WO21735 and Lot WO19711 used on C-2 and C-4 coils.

**Description of Defect / Non-Conformance**

Material does not meet the requirements of NCSX CSPEC – 141-03-09.

**Root Cause**

The specification was to have included chemical ranges to accommodate the different kinds of weld material used and accepted for the weld procedure qualifications.

**Corrective Action**

Revise specification.

**Estimated Completion Date**

**Actual Completion Date** TBD

A handwritten signature in black ink, appearing to be "C. Ruud".

Signed: C. Ruud

CC: R. Suria, Barry Craig, Joe Edwards, E.J. Kubick

**Nonconformance Report: 1423**

**Project Disposition:**

Rev. 10 of NCSX-CSPEC-141-03 now includes two tables for weld wire chemistry (3-1 and 3-2) to permit the use of both bare weld wire and coated wire electrodes.

**Approvals:**

Phil  
Heitzenroeder

Digitally signed by Phil Heitzenroeder  
DN: CN = Phil Heitzenroeder, C = US, O  
= PPPL, OU = Mech. Eng. Division  
Reason: I am the author of this document  
Date: 2005.11.07 11:36:36 -05'00'

---

Procurement Technical Representative

Brad Nelson

Digitally signed by Brad Nelson  
DN: cn=Brad Nelson, c=US, o=ORNL,  
ou=FED, email=nelsonbe@ornl.gov  
Date: 2005.11.07 13:08:04 -05'00'

---

Responsible Line Manager:

# TEAM COOPERHEAT-MQS, INC.

## RADIOGRAPHIC TECHNIQUE SHEET

FORM 20.3-61 Rev. 4

5512 W. State St-Milwaukee, WI 53208 (414) 771-3060 Fax (414)771-9481 (800) 818-6403 www.cooperheat-mqs.com

CUSTOMER RSS NO.: \_\_\_\_\_ SHEET: \_\_\_\_\_ REV: \_\_\_\_\_  
 MQS TECH. NO.: 12970  
 MQS RSS NO.: \_\_\_\_\_

CUSTOMER METALTEK INTERNATIONAL DATE: 1-18-2005

PART NO. MCWF-C12103989 DESCRIPTION C2 COIL CASTING MATERIAL CF8MNM

TOTAL NUMBER OF VIEWS 121 NUMBER X-RAY VIEWS 121 NUMBER GAMMA RAY VIEWS 0

MACH(s) MAKE(s) VARIAN MODEL(s) L2000 S/N(s) 20 MAX KV(s) 7500

SOURCE(s) N/A

PROCEDURE SPECIFICATION MSS-SP-54 ACCEPTANCE CRITERIA MSS-SP-54

MQS PROCEDURE NO. 20.H.010 REV. 0 PENETRATOR SPEC. ASTM E142-86

PROCESSING: AUTOMATIC  PROCESSOR B2000 MANUAL  TEMPERATURE 27.2°

TECHNICIAN J.P., S.S. NDT LEVEL II APPROVED BY Chris Rudolph NDT LEVEL III

VIEW IDENTIFICATION	*				
SOURCE/X-RAY MACH USED	VARIAN				
CURIES OR KV	7500				
MA OR PULSES	N/A				
SOURCE TO FILM DISTANCE	*				
EXPOSURE TIME OR RADS	*				
MATERIAL THICKNESS	I				
MATERIAL GROUP	I				
PENETRATOR SIZE/(AMT)	GP. <input type="checkbox"/>	*	SEE ATTACHED	INFORMATION	
SHIM BLOCK SIZE	GP. <input type="checkbox"/>	N/A			
FILM SIZE	*				
FILM TYPE/BRAND	*				
PB SCREEN, FRONT	.010				
PB SCREEN, BACK	.010				
SENSITIVITY	2-2T				
FILTER TYPE/LOCATION	N/A				
MASKING TYPE/LOCATION	N/A				
ANGLE	*				
NO. OF FILMS IN CASSETTE	*				
VIEWING: SING./DOUB./BOTH	S-B				
FOCAL SPOT SIZE	2 MM				
SKETCH AND/OR REMARKS	SEE ATTACHED				
GEOMETRIC UNSHARPNESS					

CUSTOMER Metalttek RSS # 12970 PART NO. MCWF-C2

VIEW	SFD	EXP. TIME	FILM TYPE	FILM SIZE	THK. RANGE	IQI
1-2	65"	25 KR	T	14 X 17	2-3/4"	50(2)
2-3	65"	25 KR	T	14 X 17	2-3/4"	50(2)
3-4	65"	25 KR	T	14 X 17	2-3/4"	50(2)
4-5	65"	25 KR	T	14 X 17	2-3/4"	50(2)
5-6	65"	25 KR	T	14 X 17	2-3/4"	50(2)
7-8	65"	25 KR	T	14 X 17	2-3/4"	50(2)
8-9	65"	25 KR	T	14 X 17	2-3/4"	50(2)
9-10	65"	25 KR	T	14 X 17	2-3/4"	50(2)
10-11	65"	25 KR	T	14 X 17	2-3/4"	50(2)
11-12	65"	25 KR	T	14 X 17	2-3/4"	50(2)
12-13	65"	25 KR	T	14 X 17	2-3/4"	50(2)
13-14	65"	25 KR	T	14 X 17	2-3/4"	50(2)
14-15	65"	25 KR	T	14 X 17	2-3/4"	50(2)
15-16	65"	25 KR	T	14 X 17	2-3/4"	50(2)
16-17	65"	25 KR	T	14 X 17	2-3/4"	50(2)
17-18	65"	25 KR	T	14 X 17	2-3/4"	50(2)
18-19	65"	25 KR	T	14 X 17	2-3/4"	50(2)
19-20	65"	25 KR	T	14 X 17	2-3/4"	50(2)
20-21	65"	25 KR	T	14 X 17	2-3/4"	50(2)
21-22	65"	25 KR	T	14 X 17	2-3/4"	50(2)
23-24	65"	25 KR	T	14 X 17	2-3/4"	50(2)
24-25	65"	25 KR	T	7 x 17	2-3/4"	50(2)
26-27	65"	25 KR	T	7 x 17	2-3/4"	50(2)
27-28	65"	25 KR	T	7 x 17	2-3/4"	50(2)
29-30	70"	25 KR	M125	14 x 17	1-1/2"	30(2)
30-31	70"	25 KR	M125	11 x 17	1-1/2"	30(2)
32-33	70"	25 KR	M125	14 x 17	1-1/2"	30(2)
33-34	70"	25 KR	M125	14 x 17	1-1/2"	30(2)
35-36	70"	25 KR	M125	11 x 14	1-1/2"	30(2)
36-37	70"	25 KR	M125	14 x 17	1-1/2"	30(2)
38-39	70"	25 KR	M125	14 x 17	1-1/2"	30(2)
39-40	70"	25 KR	M125	14 x 17	1-1/2"	30(2)
41-42	85"	35 KR	T/M125	14 X 17	1-1/2" - 2"	30, 40
42-43	85"	35 KR	T/M125	14 X 17	1-1/2" - 2"	30, 40
44-45	85"	35 KR	T/M125	14 X 17	1-1/2" - 2"	30, 40
45-46	85"	35 KR	T/M125	14 X 17	1-1/2" - 2"	30, 40
47-48	85"	35 KR	T/M125	14 X 17	1-1/2" - 2"	30, 40
48-49	85"	35 KR	T/M125	14 X 17	1-1/2" - 2"	30, 40
50-51	85"	35 KR	T/M125	14 X 17	1-1/2" - 2"	30, 40
52-53	90"	40 KR	D8/T/AA/Dumb	14 x 17	1-1/2" - 7"	30,40,100,140
53-54	90"	40 KR	D8/T/AA/Dumb	14 x 17	1-1/2" - 7"	30,40,100,140
54-55	90"	40 KR	D8/T/AA/Dumb	14 x 17	1-1/2" - 5"	30,40,100

C-2 Doc Package  
Document # 22

CUSTOMER Metaltex RSS # \_\_\_\_\_ PART NO. MCWF-C 2

VIEW	SFD	EXP. TIME	FILM TYPE	FILM SIZE	THK. RANGE	IQI
55-56	90"	40 KR	D8/T/AA/Dumb	14 x 17	1-1/2" - 5"	30,40,100
56-57	90"	40 KR	D8/T/AA/Dumb	14 x 17	1-1/2" - 5"	30,40,100
57-58	93"	65 KR	D8/AA/T/D8	14 x 17	3" - 7"	60,140
58-59	90"	40 KR	T/M125	14 x 17	1-1/2" - 2"	30,40
59-60	90"	40 KR	T/M125	14 x 17	1-1/2" - 2"	30,40
60-61	90"	40 KR	T/M125	14 x 17	1-1/2" - 2"	30,40
62-63	90"	40 KR	T/M125	14 x 17	1-1/2" - 2"	30,40
63-64	90"	35 KR	T/M125	14 x 17	1-1/2" - 2"	30,40
65-66	90"	150 KR	D8/AA/T/D8	14 x 17	1-1/2"	30(2)
67-68	90"	40 KR	T/M125	14 x 17	3" - 10"	60,140,180,200
68-69	90"	40 KR	T/M125	14 x 17	1-1/2" - 3"	30,40,60
69-70	90"	55 KR	T/M125	14 x 17	1-1/2" - 2"	30,40
V64	90"	40 KR	D8/M125/AA	14 x 17	1-1/2" - 6"	30,40,100,120
71-72	80"	50 KR	M125/M100	11 X 14	1" - 1-1/2"	20,30
72-73	80"	90 KR	AA/M125/T	14 x 17	1-1/2" - 5"	30,50,60,80,100
73-74	80"	35 KR	AA/M125/M100/T	14 x 17	1-1/2" - 5"	30,50,60,80,100
74-75	80"	35 KR	T/M125	14 x 17	1-1/2" - 4"	30,40,80
75-76	80"	35 KR	T/M125	14 x 17	1-1/2" - 4"	30,40,80
76-77	80"	30 KR	T/M125	14 x 17	1-1/2" - 2"	30,40
77-78	80"	30 KR	T/M125	11 x 14	1-1/2" - 2"	30,40
78-79	80"	35 KR	T/M125	14 x 17	1-1/2" - 3"	30,40,60
79-80	80"	35 KR	T/M125	14 x 17	1-1/2" - 2"	30,40
80-81	80"	30 KR	T/M125	14 x 17	1-1/2" - 2"	30,40
81-82	80"	30 KR	T/M125	14 x 17	1-1/2" - 2"	30,40
83-84	80"	35 KR	T/M125	7 x 17	1-1/2" - 2"	30,40
85-86	80"	35 KR	T/M125	14 x 17	1-1/2" - 3"	30,40,60
86-87	80"	30 KR	T/M125	14 x 17	1-1/2" - 2"	30,40
87-88	80"	60 KR	D8/M125/T	14 x 17	1-1/2" - 6"	30,40,120(2)
88-89	80"	30 KR	T/M125	14 x 17	1-1/2" - 2"	30,40
89-90	80"	40 KR	AA/M125/T	14 x 17	1-1/2" - 3"	30,40,60
90-91	80"	30 KR	T/M125	14 x 17	1-1/2" - 2"	30,40
92-93	80"	30 KR	T/M125	14 x 17	1-1/2" - 2"	30,40
V94	72"	25 KR	T	14 x 17	2-3/4"	50
V95	72"	25 KR	T	8 x 10	2-3/4"	50
96-97	65"	25 KR	T/T	14 x 17	2-3/4"	50(2)
97-98	65"	25 KR	T/T	14 x 17	2-3/4"	50(2)
98-99	65"	25 KR	T/T	14 x 17	2-3/4"	50(2)
100-101	65"	25 KR	T/T	14 x 17	2-3/4"	50(2)
101-102	65"	25 KR	T/T	14 x 17	2-3/4"	50(2)
102-103	65"	25 KR	T/T	14 x 17	2-3/4"	50(2)
103-104	65"	25 KR	T/T	14 x 17	2-3/4"	50(2)
104-105	65"	25 KR	T/T	14 x 17	2-3/4"	50(2)
105-107	65"	25 KR	T/T	14 x 17	2-3/4"	50(2)



C-2 Doc Package  
Document # 22

CUSTOMER Metaltelk    RSS # 12970                                  PART NO. MCWF-C2

VIEW	SFD	EXP. TIME	FILM TYPE	FILM SIZE	THK. RANGE	IQI
1-2	72"	100 KR	AA-M100	14 X 17	3" - 6"	60(2), 120(2)
2-3	72"	100 KR	AA-M100	14 X 17	3" - 6"	60(2), 120(2)
3-4	72"	100 KR	AA-AA-M100	14 X 17	3" - 8"	60(2), 120(2), 140
4-5	72"	100 KR	AA-AA-M100	14 X 17	3" - 8"	60(2), 120(2), 140
5-6	72"	100 KR	AA-AA-M100	14 X 17	3" - 8"	60(2), 120(2), 140
6-7	76"	100 KR	AA-M100	14 X 17	3" - 6"	60(2), 80, 120(2)
7-8	60"	67 KR	AA-M125-M100	14 X 17	3" - 6"	60(2), 120(2)
8-9	72"	105 KR	AA-M100	14 X 17	3" - 6"	60(2), 120(2)
9-10	72"	105 KR	AA-M100	14 X 17	3" - 6"	60(2), 120(2)
10-11	60"	67 KR	AA-M100	14 X 17	3" - 6"	60(2), 120(2)
11-12	60"	67 KR	AA-M100	14 X 17	3" - 6"	60(2), 120(2)
12-13	60"	67 KR	AA-M100	14 X 17	3" - 6"	60(2), 120(2)
13-14	74"	95 KR	AA-M100	14 X 17	3" - 6"	60(2), 120(2)
14-15	70"	90 KR	AA-M100	14 X 17	3" - 6"	60(2), 120(2)
15-16	64"	80 KR	AA-M100	14 X 17	3" - 6"	60(2), 120(2)
16-17	62"	74 KR	AA-M100	14 X 17	3" - 6"	60(2), 120(2)
17-18	60"	67 KR	AA-M100	14 X 17	3" - 6"	60(2), 120(2)
18-19	53"	55 KR	AA-M100	14 X 17	3" - 6"	60(2), 120(2)
19-20	48"	50 KR	AA-M100	14 X 17	3" - 6"	60(2), 120(2)
20-21	54"	55 KR	AA-M100	14 X 17	3" - 6"	60(2), 120(2)
21-22	65"	80 KR	AA-M100	11 X 14	3" - 6"	60(2), 120(2)
22-23	74"	110 KR	AA-M100 *	14 X 17	3" - 6"	60(2), 120(2)
23-24	74"	110 KR	AA-M100 *	14 X 17	3" - 6"	60(2), 120(2)
24-25	72"	100 KR	AA-M100	11 X 14	3" - 6"	60(2), 120(2)
25-26	72"	100 KR	AA-M100	14 X 17	3" - 6"	60(2), 120(2)
26-27	72"	95 KR	AA-M100	14 X 17	3" - 6"	60(2), 120(2)
V28	72"	100 KR	AA-M100	14 X 17	3" - 6"	60(2), 120(2)
29-30	65"	70 KR	AA-M100	14 X 17	3" - 6"	60(2), 120(2)
30-1	65"	70 KR	AA-M100	14 X 17	3" - 6"	60(2), 120(2)

Energy Industries of Ohio  
Manufacturing and Test Sequence (MTS) Serial Number C-2

1 OF 11 CO# 40851 Dated 3-9-05 Revision: Rev 4 Dated Issued: 4-18-05

OPER. #	STATION	DESCRIPTION OF PROCESS	Name	Date
10	QUALITY RELEASE	REVIEW AND APPROVE MTS. RECEIVED APPROVAL FROM EIO ON <u>4/12/05</u> FROM <u>Rate D.</u> SIGNED QUALITY MANAGER	<u>CTR</u>	<u>4/12/05</u>
15	PATTERN NPAT SOP 0100REV2	APPLY APPROPRIATE PART NUMBER, SERIAL NUMBER, AND FOUNDRY MARK, TO THE PATTERN. CAST ON BARS REQUIRED. Place numbers on the bars as to their location.	<u>By</u>	<u>4-14</u>
20	COREMAKE CORE SOP 0100 REV 6 CALIBRATION PER CORE SOP 0200R4/0300R6	MAKE CORES IN SAND MIXTURES AS DESCRIBED BY METALTEK ENGINEERING AND VERIFIED IN MODELING TRIALS. METALTEK CORE SOP 0100 REV 6) CORE WASH WITH ZIRCONIUM CORE WASH. (CALIBRATION OF EQUIPMENT REQUIRED PER CORE SOP 0200,R4 / 0300,R6)  VERIFY COUNT AND INSPECT.	<u>By</u>	<u>4-14</u>
30	MOLD MOLD SOP 0400 REV 8 CALIBRATION PER MOLD SOP 0900 REV 5 PREPARATION PER MOLD SOP 1100R2/1200R2/1300R1 SAND TESTING PER MOLD SOP 1400R2/1500R3/1600R2	MOLD PER WORK INSTRUCTIONS IN MAPICS ROUTING AND SOPS REFERENCED. ENGINEER OF RECORD - ROGER BROMAN, CONSULT ON MOLD-RELATED CONCERNS. MOLD MATERIALS REQUIRED PER MAPICS BOM. NOTIFY ENGINEER OF ANY SUBSTITUTIONS.	<u>By</u>	<u>4-14</u>
40	POUR MELT SOP 0100R5 MELT SOP 0700R2 MELT SOP 0600R2	METAL MUST BE AOD REFINED OR AOD INGOT. VIRGIN METAL ADDITIONS ALLOWED. RECORD POURING TEMPERATURE: <u>2730</u> CASTING POURED AT: <u>2730°F</u> DATE: <u>4/15/2005</u> HEAT #'s: <u>29060, 29061, 29062, 29063</u> ELAPSED POUR TIME <u>1:20</u> KEEL BLOCKS POURED: <u>cast-on 3 Laddes</u> Sample from ladle to be analyzed for final chemical analysis and reported on material certifications. Sample Taken by: <u>SR</u> Analyzed: <u>G. Huit</u> Date: <u>4/15/2005</u>	<u>J. Golobek</u>	<u>4-15-05</u>
50	MELT SOP 0800R2	SHAKEOUT	<u>CH</u>	<u>4/18/05</u>



60	ARC RISE SOP 0100R1	REMOVE RISERS AS DIRECTED BY SUPERVISOR.	RLC	4-21-05 <i>cut High</i>
70	HEAT TREAT HEAT SOP 0103R5	SOLUTION ANNEAL. MAKE SURE TO BLOCK ALL FLANGES OF FORM AND RACETRACK TO MINIMIZE CREEP DISTORTION. Soak Temp: 2050F, Soak Time: 4HR + 1/2 HR/IN, Quench Type: Air Cool	DLS	4-27-05
75	PHYSICAL TESTING	OBTAIN TEST SPECIMENS AND SUBMIT FOR PHYSICAL TESTING. REPORT RESULTS AS PART OF STEP 510.	Chl	4/29/05
NOTE		<b>THE ORDER OF CLEANING PROCESSES MAY BE ALTERED DUE TO CAPACITY CONSTRAINTS. HOLD POINTS AND COMPLIANCE WILL NOT BE COMPROMISED. EIO WILL BE ADVISED OF ALL CHANGES THAT MAY RESULT IN A REQUEST FOR DEVIATION FROM REQUIREMENTS.</b>	.	
80	GRIND GSAW SOP 0100R3	SWING GRIND TO REMOVE RISER REMAINS AND FLASH IF REQUIRED.	TJ	5-4
85	GRIND GCHI SOP 0100R2	CHIP AND HAD GRIND SURFACE OF PART AS REQUIRED FOR CONTOUR.	1st. SHIFT MIKE TOM	(5-5-05) (5-6-05)
90	SAND BLAST BLAS SOP 0100R6	SANDBLAST (REMOVE ALL BLAST MATERIAL FROM CASTING) SANDBLASTING WILL BE DONE USING RECYCLED SHARP ANGULAR AGGREGATE.	1/3	5-6-05
NOTICE	WITNESS NOTIFICATION <b>HOLD FOR EIO APPROVAL</b>	PROVIDE NOTICE TO EIO AND DCMA AT LEAST FIVE DAYS IN ADVANCE OF LAYOUT. EIO NOTIFIED ON _____ DCMA NOTIFIED ON _____  APPROVAL RECEIVED ON _____	Q ENG OR QA MGR	
100	LAYOUT SOP LAYOUT XX, TBD	INSPECT CASTING TO VERIFY DIMENSIONS. THIS STEP MAY BE DELAYED.  DIMENSIONED _____ DATE _____ RELEASED _____ (ENGINEER ONLY)		
110	VISUAL INSPECTION CQP-500 REV 4	VISUALLY INSPECT 100% of COMPONENT ACCORDING TO ASTM A802 LEVEL 3 ALL CONDITIONS. IF OK CHECK HERE _____ IF REJECTED CHECK HERE _____ . MARK AND REPAIR AT STEP 120.	VT- LEVEL II	

90 Rev  
5 issued  
5/10/05  
Chl

Energy Industries of Ohio  
Manufacturing and Test Sequence (MTS) Serial Number C-2

2 OF 11 CO# 40851 Dated 3-9-05 Revision: Rev 5 Dated Issued: 5-10-05

60	ARC RISE SOP 0100R1	REMOVE RISERS AS DIRECTED BY SUPERVISOR.		
70	HEAT TREAT HEAT SOP 0103R5	SOLUTION ANNEAL. MAKE SURE TO BLOCK ALL FLANGES OF FORM AND RACETRACK TO MINIMIZE CREEP DISTORTION. Soak Temp: 2050F, Soak Time: 4HR + 1/2 HR/IN, Quench Type: Air Cool		
75	PHYSICAL TESTING	OBTAIN TEST SPECIMENS AND SUBMIT FOR PHYSICAL TESTING. REPORT RESULTS AS PART OF STEP 510.		
NOTE		<b>THE ORDER OF CLEANING PROCESSES MAY BE ALTERED DUE TO CAPACITY CONSTRAINTS. HOLD POINTS AND COMPLIANCE WILL NOT BE COMPROMISED. EIO WILL BE ADVISED OF ALL CHANGES THAT MAY RESULT IN A REQUEST FOR DEVIATION FROM REQUIREMENTS.</b>		
80	GRIND GWA SOP 0100R3	SWING GRIND TO REMOVE RISER REMAINS AND FLASH IF REQUIRED.		
85	GRIND GCHI SOP 0100R2	CHIP AND HAD GRIND SURFACE OF PART AS REQUIRED FOR CONTOUR.		
90	SAND BLAST BLAS SOP 0100R6	SANDBLAST (REMOVE ALL BLAST MATERIAL FROM CASTING) SANDBLASTING WILL BE DONE USING RECYCLED SHARP ANGULAR AGGREGATE.		
NOTICE	WITNESS NOTIFICATION <b>HOLD FOR EIO APPROVAL</b>	PROVIDE NOTICE TO EIO AND DCMA AT LEAST FIVE DAYS IN ADVANCE OF LAYOUT. EIO NOTIFIED ON <u>5/4/03</u> DCMA NOTIFIED ON <u>5/4/03</u> APPROVAL RECEIVED ON <u>5/10/05</u> <u>CTR</u> <i>as long as length check performed ✓</i>	Q ENG OR QA MGR	<i>Chakun Q</i>
100	LAYOUT SOP LAYOUT 0100	INSPECT CASTING TO VERIFY DIMENSIONS. THIS STEP MAY BE DELAYED. DIMENSIONED _____ DATE _____ RELEASED _____ (ENGINEER ONLY) NOTE: THE FIRST PART PRODUCED OF EACH TYPE A, B AND C WILL BE DIMENSIONED BY LAWTON PATTERN. IF DIMENSIONED BY LAWTON IT WILL BE DOCUMENTED HERE. Subsequent casting done internally per Romer Arm.	JRS	5/11/05 
110	VISUAL INSPECTION CQP-500 REV 4	VISUALLY INSPECT 100% of COMPONENT ACCORDING TO ASTM A802 LEVEL 3 ALL CONDITIONS. IF OK CHECK HERE _____ IF REJECTED CHECK HERE <u>✓</u> . MARK AND REPAIR AT STEP 120.	VT - LEVEL II KRA	5/12/05

Energy Industries of Ohio  
Manufacturing and Test Sequence (MTS) Serial Number C-2

3 OF 11 CO# 40851 Dated 3-9-05 Revision: Rev 5 Dated Issued: 5-10-05

NOTICE	WITNESS NOTIFICATION	PROVIDE NOTICE TO EIO AND DCMA AT LEAST FIVE DAYS IN ADVANCE OF LP STEP. EIO NOTIFIED ON <u>5/10/05</u> DCMA NOTIFIED ON <u>5/10/05</u>	Q ENG OR QA MGR	
115	100% L.P. CQP 0300 REV 10	L.P. 100% OF COMPONENT. ACCEPTANCE PER ASTM A903. ACCEPTANCE CRITERIA-LEVEL 1 FOR HIGH STRESSED AREAS, LEVEL 2 FOR ALL OTHER AREAS. SEE LP DRAWING. IF OK CHECK HERE _____ IF REJECTED CHECK HERE <input checked="" type="checkbox"/> MARK AND REPAIR AT STEP 120.	LP - LEVEL II	<i>CHK</i>
120	WELD SOP 0100 REV 7	EXCAVATE ANY DEFECTS FOUND DURING 100% VISUAL AND LP INSPECTION.		<i>KRA</i> <i>5-12-05</i>
125	GRIND GCHI SOP 0100R2	CHIP AND HAND GRIND EXCAVATION AS REQUIRED.		<i>JP</i> <i>5-12-05</i> <i>5-13-05</i>
130	L.P. EXCAVATION CQP-300 REV 10	L.P. ALL EXCAVATIONS PRIOR TO WELDING TO ENSURE REMOVAL OF DEFECT. ACCEPTANCE PER A903. ACCEPTANCE CRITERIA-LEVEL 1 FOR HIGH STRESSED AREAS, LEVEL 2 FOR ALL OTHER AREAS. SEE LP DRAWING. IF OK CHECK HERE _____ IF REJECTED SEND BACK TO STEP 125.	LP - LEVEL II	<i>Hold pending RT. Ctr</i>
165	SAND BLAST BLAS SOP 0100R6	SANDBLAST (REMOVE ALL BLAST MATERIAL FROM CASTING) SANDBLASTING WILL BE DONE USING RECYCLED SHARP ANGULAR AGGREGATE.		<i>CA</i> <i>5-13</i>
170	<b>HOLD POINT WELD MAP</b>	MAP ALL WELDS WITH DIGITAL PHOTO/MAPS INDICATING LOCATION. SERIALIZE DEFECTS ON CASTING, USE SCALE IN PHOTOS AND DOCUMENT SIZE. THIS IS TO BE PERFORMED BY SUPERVISOR, INSPECTION LEAD MAN OR THEIR DESIGNEE, FILE WITH QA. USE YELLOW MARKER. MUST SEND REPORT ON ALL WELDS OVER 10% OF NOMINAL WALL THICKNESS TO CUSTOMER. DEFECTS > 10% YES _____, REPORT SENT BY _____ DATE _____ DEFECTS < 10% _____ SIGN BY QA ENG. <b>MAJOR WELD REPAIRS MAY NOT PROCEED UNTIL INFORMATION IS SUBMITTED.</b>		<i>Delayed test after X-ray</i> <i>CHK</i>
NOTICE	WITNESS NOTIFICATION	PROVIDE NOTICE TO EIO AND DCMA AT LEAST FIVE DAYS IN ADVANCE OF X-RAY AND DIMENSIONAL STEPS. EIO NOTIFIED ON <u>5/12/05</u> DCMA NOTIFIED ON <u>5/12/05</u>	Q ENG OR QA MGR	
190	X-RAY AT MQS MQS PROCEDURE 20.H.010 REV 0	X-RAY PER TECHNIQUE # 12726 USE CALIBRATED DENSITOMETER FOR DENSITY VERIFICATION. WHEN MARKING USE BLACK MARKERS. ATTACH TECHNIQUE, READER SHEET FOR ALL RADIOGRAPHS. MUST INDICATE RADIOGRAPHER AND ASNT CERTIFICATION LEVEL ON READER SHEET.	RT - LEVEL II	<i>CHK</i> <i>5/12</i>
			<i>RT - LEVEL II</i> <i>complete</i> <i>5/24/05</i>	<i>RT</i>

Energy Industries of Ohio  
Manufacturing and Test Sequence (MPS) Serial Number C-2

4 OF 11 CO# 40851 Dated 3-9-05 Revision Rev 5 Dated Issued: 5-10-05

C-2 Doc Package  
Document # 23

210	X-RAY CQP 401 REV 5	X-RAY INTERPRETATION. ACCEPTANCE MSS SP 54. ATTACH TECHNIQUE, READER SHEET FOR ALL RADIOGRAPHS. MUST INDICATE RADIOGRAPHER AND ASNT CERTIFICATION LEVEL ON READER SHEET. IF OK CHECK HERE _____ AND SEND TO STEP 340. REJECTED CHECK HERE <input checked="" type="checkbox"/> MARK UP DEFECTS AND SEND THE CASTING TO STEP 220.	RT - LEVEL II Completed 5/24/05 at MGS	<i>lent</i>	
220	WELD SOP 0100 REV 7	EXCAVATE ANY DEFECTS FOUND DURING RADIOGRAPHY.	<i>NC</i>	<i>6-7-05</i>	<i>Review X-rays 6/7/05</i>
225	GRIND GCHI SOP 0100R2	CHIP AND HAND GRIND EXCAVATION AS REQUIRED.	<i>DWP</i>	<i>6-8-05</i>	
230	L.P. EXCAVATION CQP-300 REV 10	L.P. ALL EXCAVATIONS PRIOR TO WELDING TO ENSURE REMOVAL OF DEFECT. ACCEPTANCE PER A903. ACCEPTANCE CRITERIA-LEVEL 1 FOR HIGH STRESSED AREAS, LEVEL 2 FOR ALL OTHER AREAS. SEE LP DRAWING. IF OK CHECK HERE _____ IF REJECTED SEND BACK TO STEP 225.	LP - LEVEL II		
240	<b>HOLD POINT WELD MAP</b>	MAP ALL WELDS WITH DIGITAL PHOTO/MAPS INDICATING LOCATION . SERIALIZE DEFECTS ON CASTING, USE SCALE IN PHOTOS AND DOCUMENT SIZE. THIS IS TO BE PERFORMED BY SUPERVISOR, INSPECTION LEAD MAN OR THEIR DESIGNEE, FILE WITH QA. MUST SEND REPORT ON ALL WELDS OVER 10% OF NOMINAL WALL THICKNESS TO CUSTOMER. DEFECTS > 10% YES <u>X</u> , REPORT SENT BY <u>R Surin</u> DATE <u>6/1/05</u> DEFECTS < 10% _____ SIGN BY QA ENG. <b>MAJOR WELD REPAIRS MAY NOT PROCEED UNTIL INFORMATION IS SUBMITTED.</b> MUST SEND REPORT ON ALL WELDS OVER 10% OF NOMINAL WALL THICKNESS TO CUSTOMER PRIOR TO REPAIR. ONCE THE REPORT IS SENT, WELDING MAY START.	<i>lent</i>	<i>6/1/05</i>	
NOTICE	WITNESS NOTIFICATION	PROVIDE NOTICE TO EIO AND DCMA AT LEAST FIVE DAYS IN ADVANCE OF WELD STEP. EIO NOTIFIED ON <u>5/25/05</u> DCMA NOTIFIED ON <u>5/25/05</u> <i>for June 1 start</i>	Q ENG OR QA MGR	<i>Qbe</i>	
260	QA APPROVAL HOLD POINT	QA TO APPROVE ELECTRODE PRIOR TO USE. PROCEDURE USED: <u>15 - GMAW CF8MN MOD</u> MATERIAL USED: <u>ENM 4455 / Heat 52743</u> <u>20 - SMAW CF8MN MOD</u> MATERIAL USED: <u>Metrolite 13816 NF Lot W019711</u> QUALITY ENG. Name: <u>R. M. J.</u> Date: <u>6/1/05</u>			
270	WELD SOP 0100 REV 7	WELD REPAIR DEFECTS AS MARKED. FOR WELDS <2" - WPS 10-SMAW-CF8MNMN MOD REV 1 FOR WELDS <8" - WPS 15-GMAW-CF8MNMN MOD REV 2 <b>ADD WPS FOR VERTICAL WELDS.</b>			<i>6/7/05</i>
280	GRIND GCHI SOP 0100R2	HAND GRIND WELDS.			<i>NA</i> ↓

210	X-RAY CQP 401 REV 5	X-RAY INTERPRETATION. ACCEPTANCE MSS SP 54. ATTACH TECHNIQUE, READER SHEET FOR ALL RADIOGRAPHS. MUST INDICATE RADIOGRAPHER AND ASNT CERTIFICATION LEVEL ON READER SHEET. IF OK CHECK HERE _____ AND SEND TO STEP 340. REJECTED CHECK HERE _____ MARK UP DEFECTS AND SEND THE CASTING TO STEP 220.	RT - LEVEL II	
220	WELD SOP 0100 REV 7	EXCAVATE ANY DEFECTS FOUND DURING RADIOGRAPHY.	<i>APC 6-10</i>	
225	GRIND GCHI SOP 0100R2	CHIP AND HAND GRIND EXCAVATION AS REQUIRED.	<i>SW 6-10</i>	
230	L.P. EXCAVATION CQP-300 REV 10	L.P. ALL EXCAVATIONS PRIOR TO WELDING TO ENSURE REMOVAL OF DEFECT. ACCEPTANCE PER A903. ACCEPTANCE CRITERIA-LEVEL 1 FOR HIGH STRESSED AREAS, LEVEL 2 FOR ALL OTHER AREAS. SEE LP DRAWING. IF OK CHECK HERE <input checked="" type="checkbox"/> IF REJECTED SEND BACK TO STEP 225.	LP - LEVEL II	
240	<b>HOLD POINT</b> WELD MAP	MAP ALL WELDS WITH DIGITAL PHOTO/MAPS INDICATING LOCATION . SERIALIZE DEFECTS ON CASTING, USE SCALE IN PHOTOS AND DOCUMENT SIZE. THIS IS TO BE PERFORMED BY SUPERVISOR, INSPECTION LEAD MAN OR THEIR DESIGNEE, FILE WITH QA. MUST SEND REPORT ON ALL WELDS OVER 10% OF NOMINAL WALL THICKNESS TO CUSTOMER. DEFECTS > 10% YES _____, REPORT SENT BY _____ DATE _____ DEFECTS < 10 % _____ SIGN BY QA ENG. <b>MAJOR WELD REPAIRS MAY NOT PROCEED UNTIL INFORMATION IS SUBMITTED.</b> MUST SEND REPORT ON ALL WELDS OVER 10% OF NOMINAL WALL THICKNESS TO CUSTOMER PRIOR TO REPAIR. ONCE THE REPORT IS SENT, WELDING MAY START.		
NOTICE	WITNESS NOTIFICATION	PROVIDE NOTICE TO EIO AND DCMA AT LEAST FIVE DAYS IN ADVANCE OF WELD STEP. EIO NOTIFIED ON _____ DCMA NOTIFIED ON _____	Q ENG OR QA MGR	
260	QA APPROVAL HOLD POINT	QA TO APPROVE ELECTRODE PRIOR TO USE. PROCEDURE USED: _____ MATERIAL/LOT USED: _____ QUALITY ENG. Name: _____ Date: _____		
270	WELD SOP 0100 REV 7	WELD REPAIR DEFECTS AS MARKED. FOR WELDS <2" - WPS 10-SMAW-CF8MNMN MOD REV 1 FOR WELDS <8" - WPS 15-GMAW-CF8MNMN MOD REV 2 <b>ADD WPS FOR VERTICAL WELDS.</b>	<i>LP</i> <i>see 6/7/05</i>	
280	GRIND GCHI SOP 0100R2	HAND GRIND WELDS.	AB	<i>6-8-05</i>

*should be doc on S220*  
*APC*

*Start 6/7/05*

290	L.P. WELD CQP 0300 REV 10	L.P. WELD REPAIRS ACCEPTANCE PER ASTM A903. ACCEPTANCE CRITERIA-LEVEL 1 FOR HIGH STRESSED AREAS, LEVEL 2 FOR ALL OTHER AREAS. SEE LP DRAWING. IF OK CHECK HERE _____ WASH AND SEND TO STEP 300. IF REJECTED CHECK HERE <input checked="" type="checkbox"/>	LP- LEVEL II TRC 6-8-05	
	REPEAT	REPEAT STEPS 220 TO 290 AS REQUIRED TILL CLEAR THROUGH VISUAL INSPECTION & PENETRANT INSPECTION. DOCUMENT REWORK ON STEPS S220 TO S290 ON LAST PAGE OF MTS. IF OK CHECK HERE _____ AND PROCEED TO STEP 295.	See S220	
295	TEST MAG PERM SOP MAG PERM 100, REV 1	TEST MAG PERMEABILITY REPAIR AREAS RECORD ON WELD MAP LIST. TEST AT LEAST 5 POINTS PER WELD. ACCEPTANCE 1.02. IF OK CHECK HERE <input checked="" type="checkbox"/> AND GO TO STEP 300. IF REJECTED CHECK HERE _____.	CA	
296	GRIND GCHI SOP 0100R2	GRIND AREAS OF NON COMPLIANCE AND RETURN TO STEP 295. REPEAT UNTIL COMPLIANCE IS ACHIEVED.	CA	
300	X-RAY ( NOTE)	IF RADIO GRAPHED AREAS ARE GREATER THAN FOUR TO FIVE INCHES THE CASTING WILL BE SENT TO MQS. SEND TO MQS CHECK HERE <input checked="" type="checkbox"/> RADIOGRAPH AT CAF CHECK HERE _____.	QA ENGINE ER RS	
310 A	MQS X-RAY DEFECTS REPAIRED BY WELDING	X-RAY PER TECHNIQUE # 12726 USE CALIBRATED DENSITOMETER FOR DENSITY VERIFICATION. ATTACH TECHNIQUE, READER SHEET FOR ALL RADIOGRAPHS. MUST INDICATE RADIOGRAPHER AND ASNT CERTIFICATION LEVEL ON READER SHEET.	LEVEL II R. Quinn R. Quinn 6/15/05	
310 B	CAF X-RAY DEFECTS REPAIRED BY WELDING CQP 401 REV 5	X-RAY PER TECHNIQUE # 12726 USE CALIBRATED DENSITOMETER FOR DENSITY VERIFICATION. ATTACH TECHNIQUE, READER SHEET FOR ALL RADIOGRAPHS. MUST INDICATE RADIOGRAPHER AND ASNT CERTIFICATION LEVEL ON READER SHEET.	RT - LEVEL II <del>TRC</del>	
320	X-RAY CQP 401 REV 5	X-RAY INTERPRETATION. ACCEPTANCE MSS SP 54. ATTACH TECHNIQUE, READER SHEET FOR ALL RADIOGRAPHS. MUST INDICATE RADIOGRAPHER AND ASNT CERTIFICATION LEVEL ON READER SHEET. IF OK CHECK HERE _____ AND SEND TO STEP 340. REJECTED CHECK HERE <input checked="" type="checkbox"/> MARK UP DEFECTS AND SEND THE CASTING TO STEP 220. OK on Reshore 4/16	RT - LEVEL II R. Quinn R. Quinn 6/15/05 6/16	
	REPEAT	REPEAT STEPS 220 TO 320 AS REQUIRED TILL WELDS CLEAR X-RAY. DOCUMENT REWORK ON A SUPPLEMENTAL MTS	QA ENG. CA	6/15/05

1st loop repair #1

Doc Repeats on last page  
CA

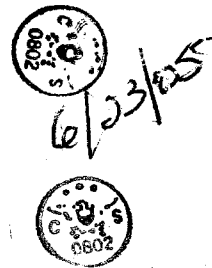

340	SAND BLAST BLAS SOP 0100R6	SANDBLAST (REMOVE ALL BLAST MATERIAL FROM CASTING) SANDBLASTING WILL BE DONE USING RECYCLED SHARP ANGULAR AGGREGATE.		
NOTICE	WITNESS NOTIFICATION	PROVIDE NOTICE TO EIO AND DCMA AT LEAST FIVE DAYS IN ADVANCE OF VISUAL AND LP STEPS. EIO NOTIFIED ON <u>6/20</u> DCMA NOTIFIED ON <u>6/20</u>	Q ENG OR QA MGR	<i>MTW</i> <i>6/16/05</i> <i>Chz</i>
350	FINAL VISUAL INSPECTION CQP-500 REV 4	VISUALLY INSPECT 100% of COMPONENT ACCORDING TO ASTM A802 LEVEL 2 ALL CONDITIONS. IF OK CHECK HERE _____ IF REJECTED CHECK HERE <input checked="" type="checkbox"/> . MARK AND REPAIR AT STEP 385. MUST BE PERFORMED BY LEVEL II in VT.	VT - LEVEL II	<i>HTA</i> <i>6-24-05</i>
360	FINAL L.P. CQP 0300 REV 10	FINAL L.P. 100% OF COMPONENT. ACCEPTANCE PER ASTM A903. ACCEPTANCE CRITERIA-LEVEL 1 FOR HIGH STRESSED AREAS, LEVEL 2 FOR ALL OTHER AREAS. SEE LP DRAWING. IF OK CHECK HERE _____ WASH AND SEND TO STEP 455. IF REJECTED CHECK HERE <input checked="" type="checkbox"/>	LP - LEVEL II	<i>JPS</i> <i>6-23</i>
380	WELD SOP 0100 REV 7	EXCAVATE ANY DEFECTS FOUND DURING FINAL PENETRANT INSPECTION.		<i>N/A</i>
385	GRIND GCHI SOP 0100R2	CHIP AND HAD GRIND EXCAVATION AS REQUIRED.		<i>AB</i> <i>5/5/05</i> <i>6/28-05</i>
390	L.P. EXCAVATION CQP-300 REV 10	L.P. ALL EXCAVATIONS PRIOR TO WELDING TO ENSURE REMOVAL OF DEFECT. ACCEPTANCE PER A903. IF OK CHECK HERE <input checked="" type="checkbox"/> IF REJECTED SEND BACK TO STEP 385.	LP - LEVEL II	<i>ADR</i> <i>6-23-05</i>
400	<b>HOLD POINT</b> WELD MAP	MAP ALL WELDS WITH DIGITAL PHOTO/MAPS INDICATING LOCATION. SERIALIZE DEFECTS ON CASTING, USE SCALE IN PHOTOS AND DOCUMENT SIZE. THIS IS TO BE PERFORMED BY SUPERVISOR, INSPECTION LEAD MAN OR THEIR DESIGNEE. FILE WITH QA. MUST SEND REPORT ON ALL WELDS OVER 10% OF NOMINAL WALL THICKNESS TO CUSTOMER. DEFECTS.>10% YES _____, REPORT SENT BY _____ DATE _____ DEFECTS < 10 % _____ SIGN BY QA ENG. <b>MAJOR WELD REPAIRS MAY NOT PROCEED UNTIL INFORMATION IS SUBMITTED.</b> MUST SEND REPORT ON ALL WELDS OVER 10% OF NOMINAL WALL THICKNESS TO CUSTOMER PRIOR TO REPAIR. ONCE THE REPORT IS SENT, WELDING MAY START.		<i>N/A</i>



Energy Industries of Ohio  
Manufacturing and Test Sequence (MTS) Serial Number C-2

7 OF 11 CO# 40851 Dated 3-9-05 Revision: Rev 6 Dated Issued: 5-29-05

C-2 Doc Package  
Document # 23

420	QA APPROVAL HOLD POINT	QA TO APPROVE ELECTRODE PRIOR TO USE. PROCEDURE USED: _____ MATERIAL/LOT USED: _____ QUALITY ENG. Name: _____ Date: _____	N/A	
430	WELD SOP 0100 REV 7	WELD REPAIR DEFECTS AS MARKED. FOR WELDS <2" - WPS 10-SMAW-CF8MNMN MOD REV 1 FOR WELDS <8" - WPS 15-GMAW-CF8MNMN MOD REV 2 <b>ADD WPS FOR VERTICAL WELDS.</b>	N/A	
440	GRIND GCHI SOP 0100 REV 2	HAND GRIND WELDS.		
450	L.P. WELDS CQP 0300 REV 10	L.P. WELD REPAIRS ACCEPTANCE PER ASTM A903. IF OK CHECK HERE _____ WASH AND SEND TO STEP 460. IF REJECTED CHECK HERE _____ AND RETURN TO STEP 440.	LP LEVEL II	
	REPEAT	REPEAT STEPS 350 TO 450 AS REQUIRED TILL WELDS CLEAR FINAL LIQUID PENETRANT INSPECTION. DOCUMENT REWORK ON A SUPPLEMENTAL MTS	QA ENG.	
NOTICE	WITNESS NOTIFICATION	PROVIDE NOTICE TO EIO AND DCMA AT LEAST FIVE DAYS IN ADVANCE OF VISUAL AND LP STEPS. EIO NOTIFIED ON <u>6/20/05</u> DCMA NOTIFIED ON <u>6/20/05</u>	Q ENG OR QA MGR	<i>[Signature]</i>
460	FINAL VISUAL INSPECTION CQP-500 REV 4	VISUALLY INSPECT 100% of COMPONENT ACCORDING TO ASTM A802 LEVEL 2 ALL CONDITIONS. IF OK CHECK HERE _____ IF REJECTED CHECK HERE <input checked="" type="checkbox"/> MARK AND REPAIR AT STEP 390. MUST BE PERFORMED BY LEVEL II in VT.	VT - LEVEL II <i>KRA 6-24-05</i>	
470	FINAL L.P. CQP 0300 REV 10	FINAL L.P. 100% OF COMPONENT. ACCEPTANCE PER ASTM A903. ACCEPTANCE CRITERIA-LEVEL 1 FOR HIGH STRESSED AREAS, LEVEL 2 FOR ALL OTHER AREAS. SEE LP DRAWING. IF OK CHECK HERE <input checked="" type="checkbox"/> WASH AND SEND TO STEP 455. IF REJECTED CHECK HERE _____	LP - LEVEL II <i>JDR 6-23-05</i>	
480	TEST MAG PERM SOP MAG PERM 100, REV 1	TEST MAG PERMEABILITY REPAIR AREAS. RECORD ON WELD MAP LIST. TEST AT LEAST 5 POINTS PER WELD. ACCEPTANCE 1.02. IF OK CHECK HERE <input checked="" type="checkbox"/> AND GO TO STEP 430. IF REJECTED CHECK HERE _____ <i>Performed on entire part 100% Pictures provided to DCMA</i>	RC <i>23-05</i>	
490	GRIND GCHI SOP 0100R2	GRIND AREAS OF NON COMPLIANCE AND RETURN TO STEP 451. REPEAT UNTIL COMPLIANCE IS ACHIEVED.	N/A	



Energy Industries of Ohio

Manufacturing and Test Sequence (MTS) Serial Number C-2

8 OF 11

CO# 40851 Dated 3-9-05 Revision: Rev 6

Dated Issued: 5-29-05

NOTICE	WITNESS NOTIFICATION	PROVIDE NOTICE TO EIO AND DCMA AT LEAST FIVE DAYS IN ADVANCE OF MAG PERM STEPS. EIO NOTIFIED ON <u>6/20</u> DCMA NOTIFIED ON <u>6/20</u>	Q ENG OR QA MGR	<i>cdn</i>
500	FINAL MAG PERM INSPECTION SOP MAG PERM 100, REV 1	PERFORM MAG PERM TESTING WITH SEVRIN GAUGE. ACCEPTANCE 1.02. CHECK THE ENTIRE SURFACE ON A 6"BY6" GRID. REPORT RESULTS. USE A 6" SQUARE BLOCK TO INDICATE TEST LOCATIONS AND RECORD RESULTS. COMPLIANT AREAS WILL NOT BE MARKED. MARK NONCOMPLIANT AREAS WITH AN "X" FOR REPAIR. OK CHECK HERE _____ AND GO TO STEP 530. IF REJECTED CHECK HERE _____	<i>N/A</i>	
510	GRIND GCHI SOP 0100 REV 2	HAND GRIND WITH SUITABLE CONE OR OTHER SIMILAR GRINDER AS REQUIRED TO ENSURE REMOVAL OF MATERIAL TO ACHIEVE MAG PERM REQUIREMENT. CIRCLE AREA REMEDIATE FOR RETEST.		
520	RETEST MAG PERM SOP MAG PERM 100, REV 1	RETEST MAG PERMEABILITY AT FAILED TEST POINTS. MARK NONCOMPLIANT AREAS WITH AN "X" FOR REPAIR. ACCEPTANCE 1.02. IF OK CHECK HERE _____ . IF REJECTED CHECK HERE _____ RETURN TO STEP 510.		
530	DOC. REVIEW	REVIEW DOCUMENTS AS REQUIRED IN CAF CHECKLIST, ALL DOCUMENTS NOTED TO BE ACCESSIBLE FOR AUDITING. (SHIPPER, C OF C, M.T.R., M.T.S., INSPECTION REPORT, X-RAY READER SHEETS AND HEAT TREAT CHARTS)		
NOTICE	RELEASE FROM EIO	PROVIDE DOCUMENTS TO EIO. SENT ON <u>6/24/05</u> BY <u>cdn</u> . RECEIVED RELEASE FROM EIO ON _____.	Q ENG OR QA MGR	<i>cdn</i> <u>6/24/05</u>
540	PACK AND SHIP	PACKAGE AND SHIP TO MAJOR TOOL.		
1000	REVISION HISTORY	ORIGINAL 12-14-04. Approved 12-14-04. Revision level 1- Revised 1-26-05 new page 8, correct High stress areas, Revision level 2 3-16-05, delete LO step 455. Revision 3 3-28-05 Added note regarding hold point at weld step 400. Revision level 4 written for C-2 casting 4-18-05. Rev 5 added Layout SOP# and note regarding first casting layout responsibility. 5-10-05 Rev 6 added step 420 and "LOT" to step 260 and 420.5-29-05	CARUUD	

C-2 Doc Package  
Document # 23



GENERAL ISOMETRIC  
VIEW FROM TOP SIDE

TABS DESIGNATE  
CRITICAL AREA

RED AREA INDICATES HIGH STRESSED AREA

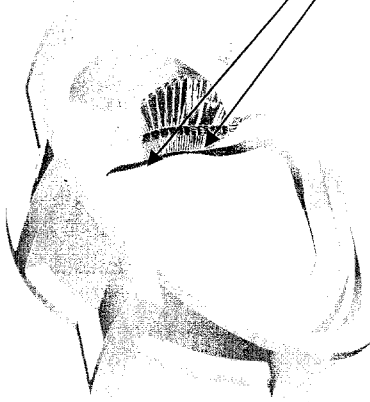

TOP SIDE ISOMETRIC

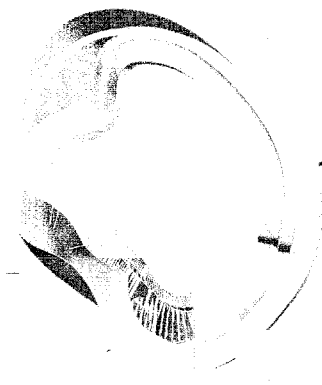

TOP SIDE VIEW

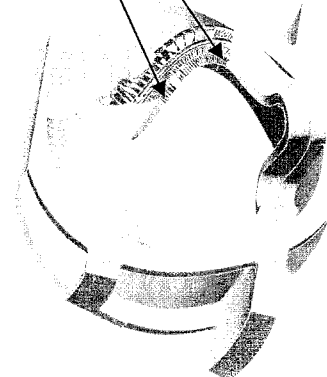

BOTTOM SIDE ISOMETRIC



BOTTOM SIDE VIEW

start 4/15/05

	REPEAT STEPS	SUPPLEMENTAL REPAIR STEPS	1 <sup>ST</sup> H	2 <sup>N</sup> D	3 <sup>RD</sup>	4 <sup>TH</sup>	5 <sup>T</sup> H
S220	WELD SOP 0100 REV 7	EXCAVATE ANY DEFECTS FOUND DURING RADIOGRAPHY.	JC 4/15/05				
S230	L.P. EXCAVATION CQP-300 REV 10	L.P. ALL EXCAVATIONS PRIOR TO WELDING TO ENSURE REMOVAL OF DEFECT. ACCEPTANCE PER A903. ACCEPTANCE CRITERIA-LEVEL 1 FOR HIGH STRESSED AREAS, LEVEL 2 FOR ALL OTHER AREAS. SEE LP DRAWING.	LP - LEVE L II SB 6/15/05				
S240	WELD MAP	MAP ALL WELDS WITH DIGITAL PHOTO/MAPS INDICATING LOCATION. SERIALIZE DEFECTS ON CASTING, USE SCALE IN PHOTOS AND DOCUMENT SIZE. THIS IS TO BE PERFORMED BY SUPERVISOR, INSPECTION LEAD MAN OR THEIR DESIGNEE, FILE WITH QA. MUST SEND REPORT ON ALL WELDS OVER 10% OF NOMINAL WALL THICKNESS TO CUSTOMER. DEFECTS > 10% YES <input checked="" type="checkbox"/> , REPORT SENT BY <u>Ctn</u> DATE <u>6/15/05</u> DEFECTS < 10% _____ SIGN BY QA ENG. <b>REPAIRS MAY NOT PROCEED UNTIL INFORMATION IS SUBMITTED.</b>	Ctn				
NOTICE	WITNESS NOTIFICATION	PROVIDE NOTICE TO EIO AND DCMA AT LEAST FIVE DAYS IN ADVANCE OF WELD STEP. EIO NOTIFIED ON <u>6/13/05</u> DCMA NOTIFIED ON <u>6/13/05</u>	Q ENG OR QA MGR	Ctn 4/12			
S260	QA APPROVAL HOLD POINT	QA TO APPROVE ELECTRODE PRIOR TO USE. PROCEDURE USED: <u>WPS 10-SMAW-CF8MNMN MOD REV 1</u> MATERIAL <u>Lot 4455</u> USED: QUALITY ENG. Name: <u>Ctn</u> Date: <u>6/15</u> <u>4455</u> <u>Lot 4455</u> <u>Lot 4455</u> <u>Lot 4455</u>	Ctn 4/15				
S270	WELD SOP 0100 REV 7	<u>WELD REPAIR DEFECTS AS MARKED.</u> <u>FOR WELDS &lt; 2" - WPS 10-SMAW-CF8MNMN MOD REV 1</u> <u>FOR WELDS &lt; 8" - WPS 15-GMAW-CF8MNMN MOD REV 2</u> <b>ADD WPS FOR VERTICAL WELDS.</b>	JC 6-15 6-23-05				
S280	GRIND GCHI SOP 0100R2	HAND GRIND WELDS.	JC 6-15 6-23-05				
S290	L.P. WELD CQP 0300 REV 10	L.P. WELD REPAIRS ACCEPTANCE PER ASTM A903. ACCEPTANCE CRITERIA-LEVEL 1 FOR HIGH STRESSED AREAS, LEVEL 2 FOR ALL OTHER AREAS. SEE LP DRAWING. IF OK CHECK HERE <input checked="" type="checkbox"/> WASH AND SEND TO STEP 300. IF REJECTED CHECK HERE _____ AND RETURN TO STEP 220.	LP - LEVE L II JOK 4/15	OK OK OK REJ	OK OK OK REJ	OK OK OK REJ	

Added  
lot of  
weld material  
Per Rev 1  
Ctn

all grind  
of LP ind  
Ctn

to XRAY 4/16

	REPEAT	REPEAT STEPS S220 TO S290 AS REQUIRED TILL CLEAR THROUGH VISUAL INSPECTION & PENETRANT INSPECTION. DOCUMENT REWORK ON A SUPPLEMENTAL MTS	GA	423	90	40	460		

NOTES: Stress relieve of C-2 Coil Casting

C-2 Doc Package  
Document # 24

### SUPPLEMENTAL ROUTING CARD

Date: 6-20-05

PART NUMBER: C-2 Coil

SERIAL NUMBER: C-1

AUTHORITY  
C Ruud

OPER  
NUMBER

STATION

OPERATOR  
SIGN/DATE

Extra  
operation

Heat treat

Load casting into cold furnace. Ramp up to 1100 F at rate of 200 F per hour. Hold at temp 4-5 hours. Furnace cool to 500 F at 50 F per hour. Air cool. Submit furnace charts to QA.

FS-1  
DLS  
6-21-05

**Qualify Report**

C-2 Doc Package  
Document # 25

**Date Generated: 5/22/2005, 11:49 am**

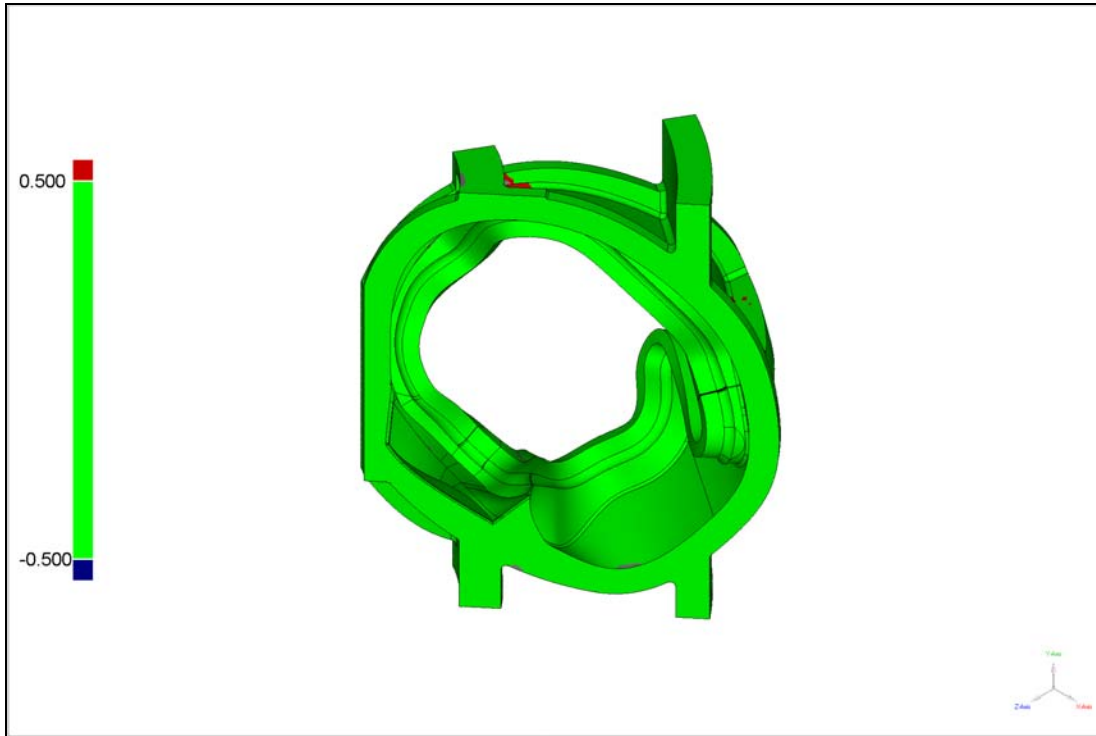

**Author: Kevin Harris / Jarrod Boyer**

**Part: C2**

**Test: Merged Points 1**

**Annotated: Annotation View Top**

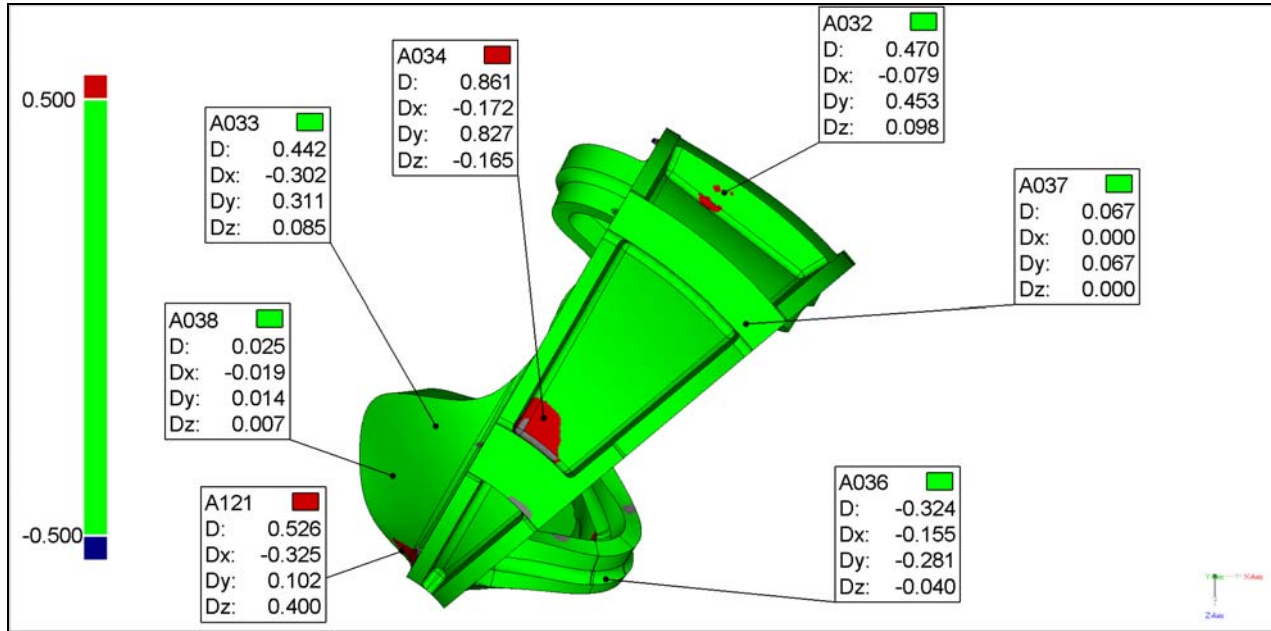

Units: in

Name	Dev	Status	Tol +	Tol -	Ref X	Ref Y	Ref Z	Dev Radius	Dev X	Dev Y	Dev Z	Test X	Test Y	Test Z
A032	0.470	FAIL	0.100	-0.100	54.294	11.519	-71.235	0.039	-0.079	0.453	0.098	54.215	11.972	-71.137
A033	0.442	FAIL	0.100	-0.100	11.899	30.670	-36.884	0.039	-0.302	0.311	0.085	11.597	30.981	-36.798
A034	0.861	FAIL	0.100	-0.100	27.749	40.157	-38.073	0.039	-0.172	0.827	-0.165	27.577	40.984	-38.237
A036	-0.324	FAIL	0.100	-0.100	36.863	-3.808	-14.297	0.039	-0.155	-0.281	-0.040	36.708	-4.090	-14.337
A037	0.067	PASS	0.100	-0.100	57.469	48.188	-51.942	0.039	0.000	0.067	0.000	57.469	48.255	-51.942
A038	0.025	PASS	0.100	-0.100	5.558	19.704	-29.553	0.039	-0.019	0.014	0.007	5.539	19.718	-29.546
A121	0.526	FAIL	0.100	-0.100	6.945	8.741	-18.458	0.039	-0.325	0.102	0.400	6.620	8.843	-18.057

**Annotated: Annotation View Bottom**

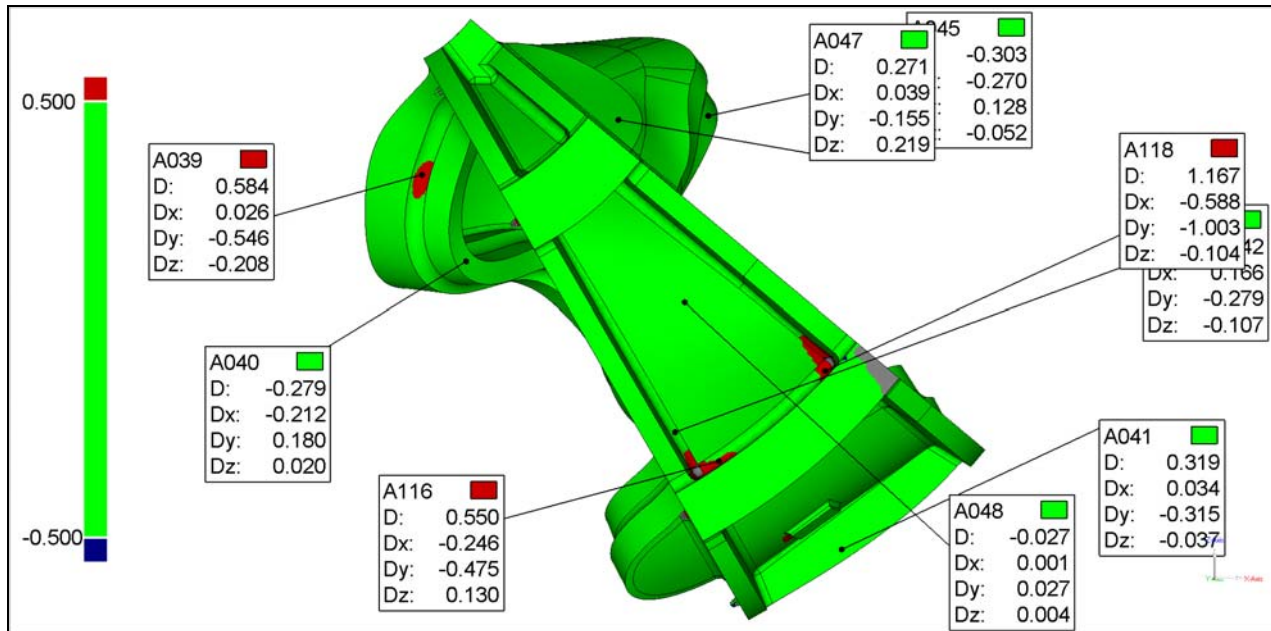

Units: in

Name	Dev	Status	Tol +	Tol -	Ref X	Ref Y	Ref Z	Dev Radius	Dev X	Dev Y	Dev Z	Test X	Test Y	Test Z
A039	0.584	FAIL	0.100	-0.100	7.399	10.856	-28.360	0.039	0.026	-0.546	-0.208	7.425	10.310	-28.567
A040	-0.279	FAIL	0.100	-0.100	12.590	14.051	-38.580	0.039	-0.212	0.180	0.020	12.377	14.230	-38.560
A041	0.319	FAIL	0.100	-0.100	56.713	6.078	-72.483	0.039	0.034	-0.315	-0.037	56.747	5.762	-72.520
A044	0.342	FAIL	0.100	-0.100	37.135	-31.757	-58.654	0.039	0.166	-0.279	-0.107	37.301	-32.037	-58.761
A045	-0.303	FAIL	0.100	-0.100	41.032	-8.625	-21.418	0.039	-0.270	0.128	-0.052	40.762	-8.497	-21.469
A047	0.271	FAIL	0.100	-0.100	30.470	-23.402	-21.884	0.039	0.039	-0.155	0.219	30.509	-23.558	-21.665
A048	-0.027	PASS	0.100	-0.100	38.270	-38.262	-43.393	0.039	0.001	0.027	0.004	38.270	-38.235	-43.390
A116	0.550	FAIL	0.100	-0.100	42.288	-28.727	-62.067	0.039	-0.246	-0.475	0.130	42.042	-29.202	-61.937
A118	1.167	FAIL	0.100	-0.100	54.773	-33.113	-51.430	0.039	-0.588	-1.003	-0.104	54.185	-34.115	-51.534



**Annotated: Annotation View Left**

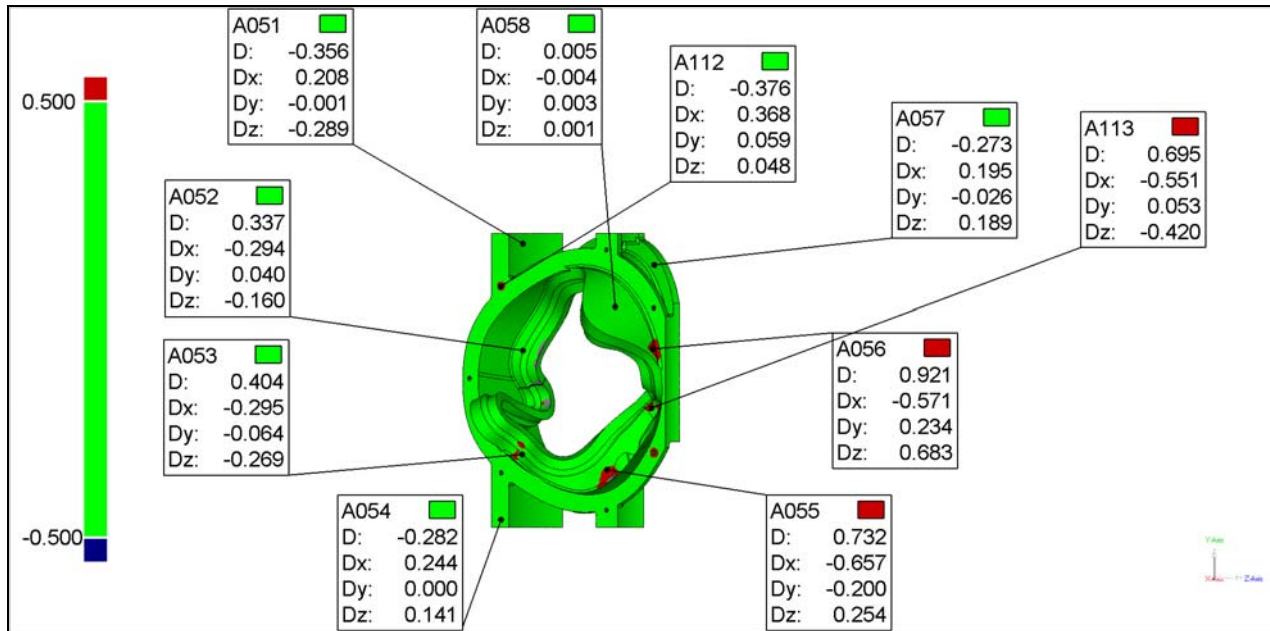

Units: in

Name	Dev	Status	Tol +	Tol -	Ref X	Ref Y	Ref Z	Dev Radius	Dev X	Dev Y	Dev Z	Test X	Test Y	Test Z
A051	-0.356	FAIL	0.100	-0.100	44.544	44.812	-61.169	0.039	0.208	-0.001	-0.289	44.752	44.811	-61.458
A052	0.337	FAIL	0.100	-0.100	53.352	9.964	-61.169	0.039	-0.294	0.040	-0.160	53.058	10.004	-61.329
A053	0.404	FAIL	0.100	-0.100	36.665	-24.158	-61.411	0.039	-0.295	-0.064	-0.269	36.371	-24.222	-61.680
A054	-0.282	FAIL	0.100	-0.100	38.553	-45.608	-68.276	0.039	0.244	0.000	0.141	38.798	-45.608	-68.135
A055	0.732	FAIL	0.100	-0.100	32.132	-29.208	-33.635	0.039	-0.657	-0.200	0.254	31.476	-29.408	-33.381
A056	0.921	FAIL	0.100	-0.100	7.357	10.477	-18.642	0.039	-0.571	0.234	0.683	6.786	10.711	-17.959
A057	-0.273	FAIL	0.100	-0.100	18.242	37.816	-18.201	0.039	0.195	-0.026	0.189	18.437	37.790	-18.012
A058	0.005	PASS	0.100	-0.100	8.213	24.147	-30.989	0.039	-0.004	0.003	0.001	8.209	24.149	-30.988
A112	-0.376	FAIL	0.100	-0.100	37.662	30.761	-68.470	0.039	0.368	0.059	0.048	38.030	30.820	-68.421
A113	0.695	FAIL	0.100	-0.100	34.410	-8.925	-19.083	0.039	-0.551	0.053	-0.420	33.859	-8.871	-19.503

**Annotated: Annotation View Right**

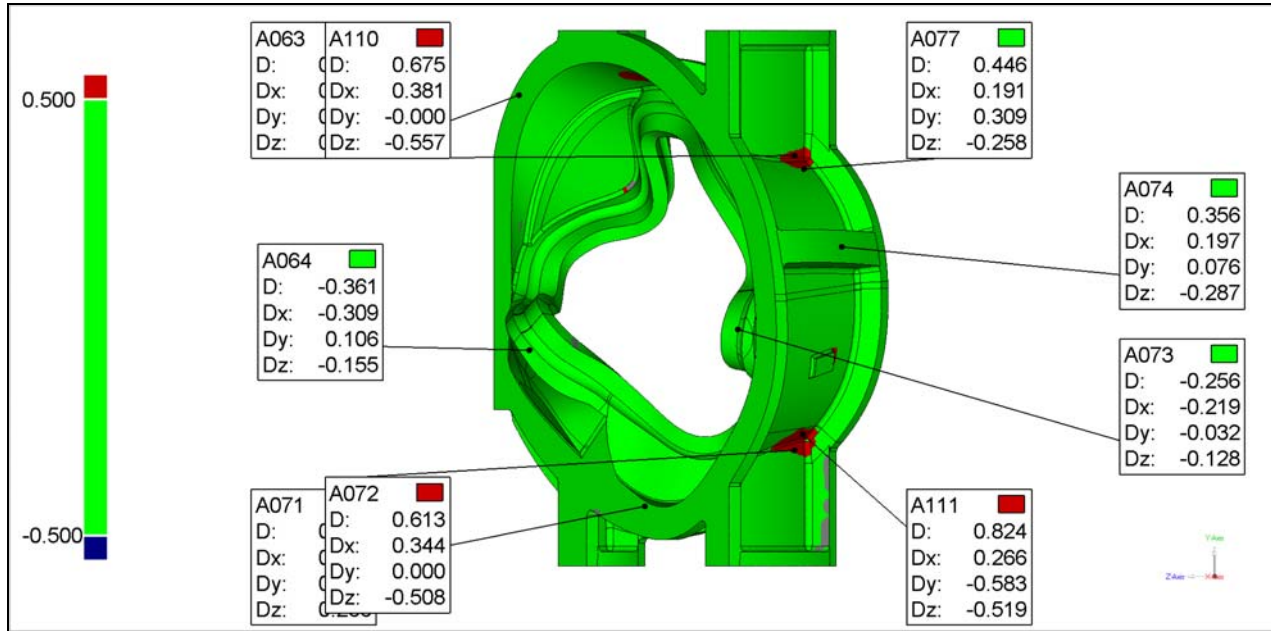

Units: in

Name	Dev	Status	Tol +	Tol -	Ref X	Ref Y	Ref Z	Dev Radius	Dev X	Dev Y	Dev Z	Test X	Test Y	Test Z
A063	0.379	FAIL	0.100	-0.100	18.531	36.560	-14.571	0.039	0.244	0.000	0.290	18.775	36.560	-14.280
A064	-0.361	FAIL	0.100	-0.100	40.476	-9.285	-16.439	0.039	-0.309	0.106	-0.155	40.167	-9.179	-16.594
A071	0.348	FAIL	0.100	-0.100	45.441	-37.411	-37.150	0.039	0.223	0.000	0.266	45.664	-37.411	-36.884
A072	0.613	FAIL	0.100	-0.100	43.968	-27.330	-64.018	0.039	0.344	0.000	-0.508	44.312	-27.330	-64.526
A073	-0.256	FAIL	0.100	-0.100	65.593	-5.551	-53.854	0.039	-0.219	-0.032	-0.128	65.374	-5.583	-53.983
A074	0.356	FAIL	0.100	-0.100	57.859	9.211	-72.488	0.039	0.197	0.076	-0.287	58.056	9.287	-72.775
A077	0.446	FAIL	0.100	-0.100	44.242	23.247	-65.712	0.039	0.191	0.309	-0.258	44.433	23.557	-65.970
A110	0.675	FAIL	0.100	-0.100	43.968	25.667	-64.018	0.039	0.381	-0.000	-0.557	44.349	25.667	-64.575
A111	0.824	FAIL	0.100	-0.100	44.012	-24.426	-65.470	0.039	0.266	-0.583	-0.519	44.278	-25.010	-65.989

**Annotated: Annotation View Front**

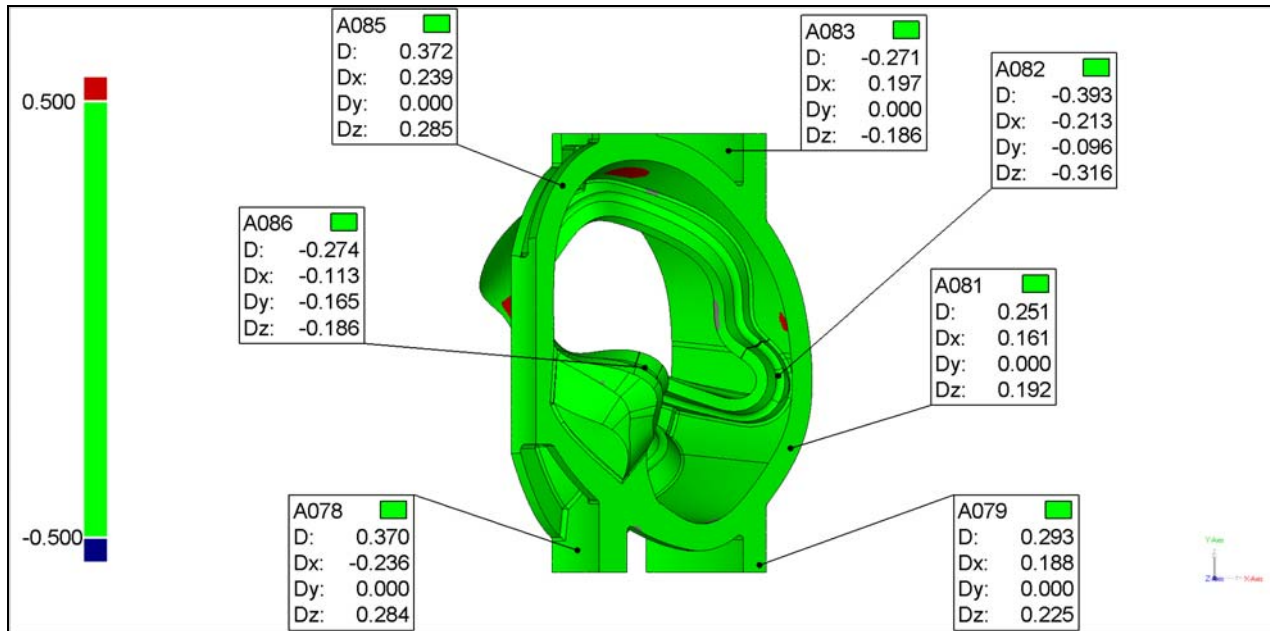

Units: in

Name	Dev	Status	Tol +	Tol -	Ref X	Ref Y	Ref Z	Dev Radius	Dev X	Dev Y	Dev Z	Test X	Test Y	Test Z
A078	0.370	FAIL	0.100	-0.100	22.125	-43.372	-26.471	0.039	-0.236	0.000	0.284	21.889	-43.372	-26.187
A079	0.293	FAIL	0.100	-0.100	62.028	-46.623	-51.069	0.039	0.188	0.000	0.225	62.216	-46.623	-50.844
A081	0.251	FAIL	0.100	-0.100	68.826	-20.908	-56.773	0.039	0.161	0.000	0.192	68.987	-20.908	-56.581
A082	-0.393	FAIL	0.100	-0.100	66.166	-4.946	-54.617	0.039	-0.213	-0.096	-0.316	65.953	-5.043	-54.932
A083	-0.271	FAIL	0.100	-0.100	55.230	44.415	-51.785	0.039	0.197	0.000	-0.186	55.427	44.415	-51.971
A085	0.372	FAIL	0.100	-0.100	18.874	36.730	-14.858	0.039	0.239	0.000	0.285	19.113	36.730	-14.573
A086	-0.274	FAIL	0.100	-0.100	36.904	-3.173	-15.496	0.039	-0.113	-0.165	-0.186	36.791	-3.338	-15.682

**Annotated: Annotation View Back**

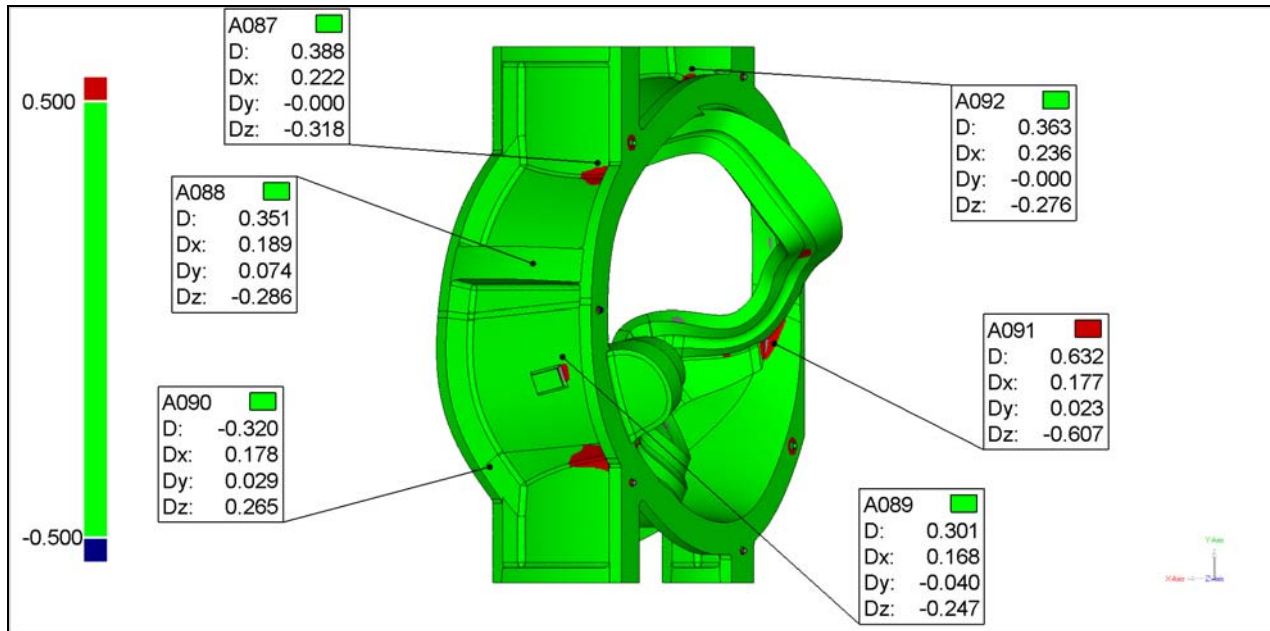

Units: in

Name	Dev	Status	Tol +	Tol -	Ref X	Ref Y	Ref Z	Dev Radius	Dev X	Dev Y	Dev Z	Test X	Test Y	Test Z
A087	0.388	FAIL	0.100	-0.100	44.656	27.300	-63.543	0.039	0.222	-0.000	-0.318	44.878	27.300	-63.861
A088	0.351	FAIL	0.100	-0.100	56.271	9.151	-73.572	0.039	0.189	0.074	-0.286	56.460	9.225	-73.859
A089	0.301	FAIL	0.100	-0.100	50.948	-7.547	-71.367	0.039	0.168	-0.040	-0.247	51.115	-7.587	-71.614
A090	-0.320	FAIL	0.100	-0.100	64.015	-27.391	-56.486	0.039	0.178	0.029	0.265	64.193	-27.363	-56.221
A091	0.632	FAIL	0.100	-0.100	12.954	-5.127	-14.409	0.039	0.177	0.023	-0.607	13.131	-5.105	-15.016
A092	0.363	FAIL	0.100	-0.100	27.716	44.240	-32.733	0.039	0.236	-0.000	-0.276	27.952	44.240	-33.009

**Annotated: Annotation View Isometric**

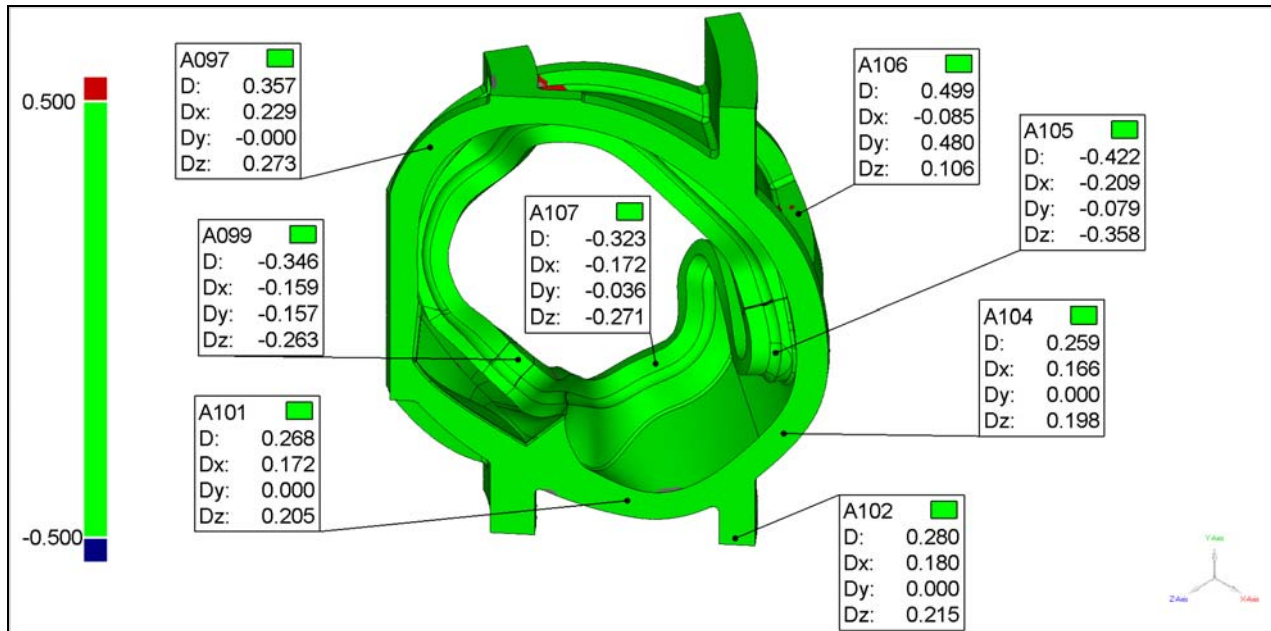

Units: in

Name	Dev	Status	Tol +	Tol -	Ref X	Ref Y	Ref Z	Dev Radius	Dev X	Dev Y	Dev Z	Test X	Test Y	Test Z
A097	0.357	FAIL	0.100	-0.100	18.638	35.973	-14.660	0.039	0.229	-0.000	0.273	18.868	35.973	-14.387
A099	-0.346	FAIL	0.100	-0.100	38.499	-2.006	-17.121	0.039	-0.159	-0.157	-0.263	38.340	-2.164	-17.385
A101	0.268	FAIL	0.100	-0.100	45.849	-39.638	-37.493	0.039	0.172	0.000	0.205	46.021	-39.638	-37.288
A102	0.280	FAIL	0.100	-0.100	60.736	-46.739	-49.985	0.039	0.180	0.000	0.215	60.917	-46.739	-49.770
A104	0.259	FAIL	0.100	-0.100	67.436	-23.082	-55.606	0.039	0.166	0.000	0.198	67.602	-23.082	-55.408
A105	-0.422	FAIL	0.100	-0.100	66.355	-5.353	-54.634	0.039	-0.209	-0.079	-0.358	66.146	-5.431	-54.992
A106	0.499	FAIL	0.100	-0.100	55.821	11.733	-70.985	0.039	-0.085	0.480	0.106	55.736	12.213	-70.879
A107	-0.323	FAIL	0.100	-0.100	35.687	-23.162	-54.842	0.039	-0.172	-0.036	-0.271	35.515	-23.198	-55.113

**Qualify Report**

C-2 Doc Package  
Document # 25a

Date Generated: 5/23/2005, 5:05 pm

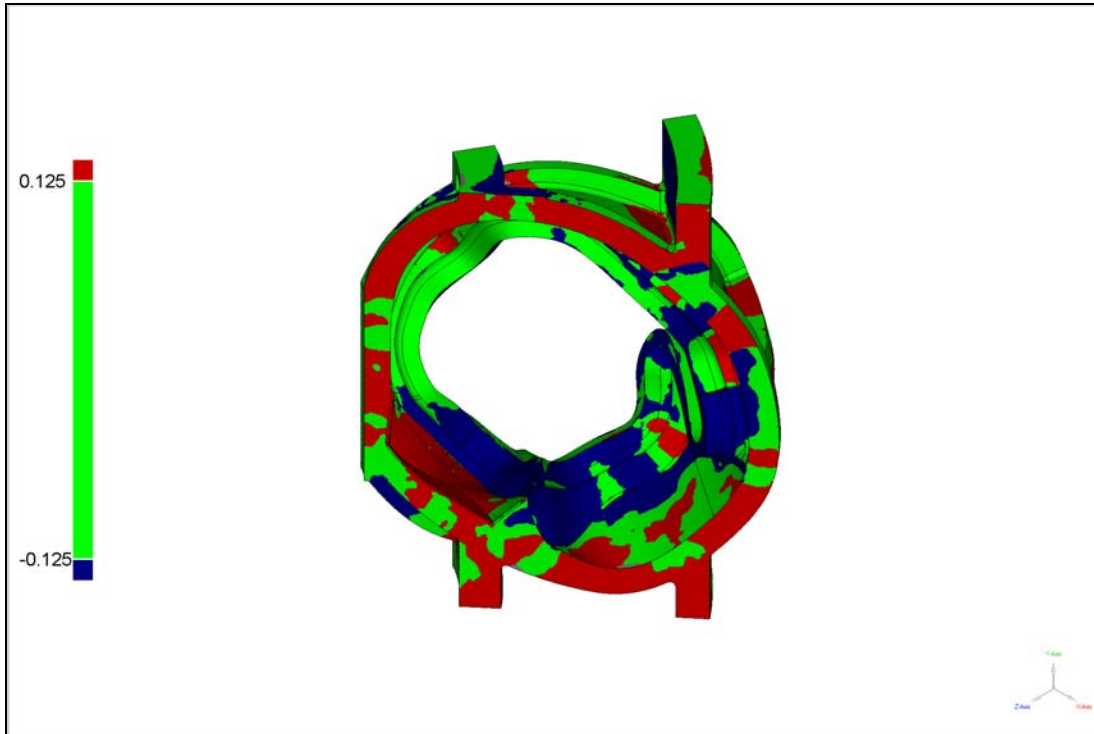

**Author: Kevin Harris / Jarrod Boyer**

**Part: C2**

**Test: Merged Points 1**

### 3D Comparison Results

Reference Model	c-coil-casting
Test Model	Merged Points 1
# Data Points	5326043

Tolerances	in
Max Tol +	0.125
Min Tol +	0.125
Min Tol -	-0.125
Max Tol -	-0.125

Deviation	in
Max Dev +	2.048
Max Dev -	-2.060
Average +/-	0.132 / -0.115
Std Dev	0.172

#### Percentage Deviations

>=Min	<Max	# Points	%
-0.125	0.125	3257136	61.155

Out of Max Tol +	1067561	20.044
Out of Max Tol -	1001346	18.801

#### Standard Deviations

Distribution ( )	# Points	%
-6 * Std Dev	38	0.001
-5 * Std Dev	384	0.007
-4 * Std Dev	674	0.013
-3 * Std Dev	2880	0.054
-2 * Std Dev	201623	3.786
-1 * Std Dev	1206953	22.661
1 * Std Dev	2451060	46.020
2 * Std Dev	1137309	21.354
3 * Std Dev	230395	4.326
4 * Std Dev	52331	0.983
5 * Std Dev	20317	0.381
6 * Std Dev	12930	0.243

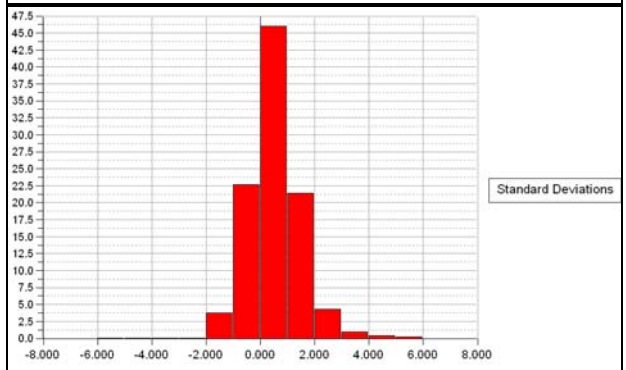
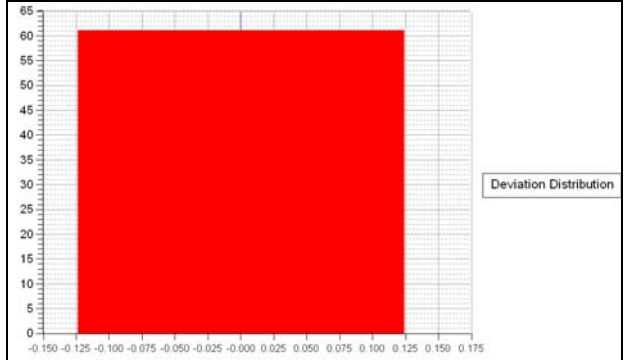
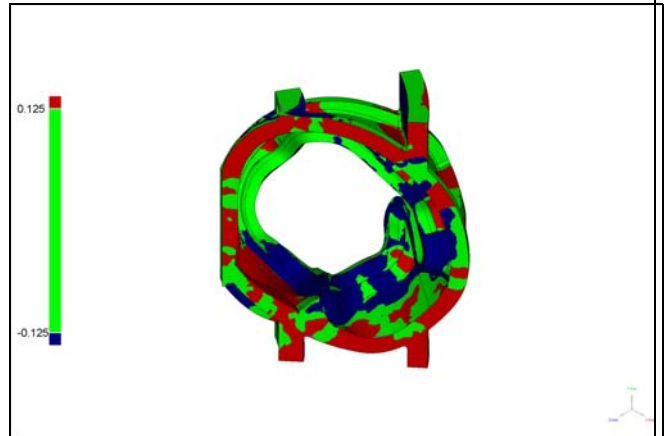

**Predefined: Front**

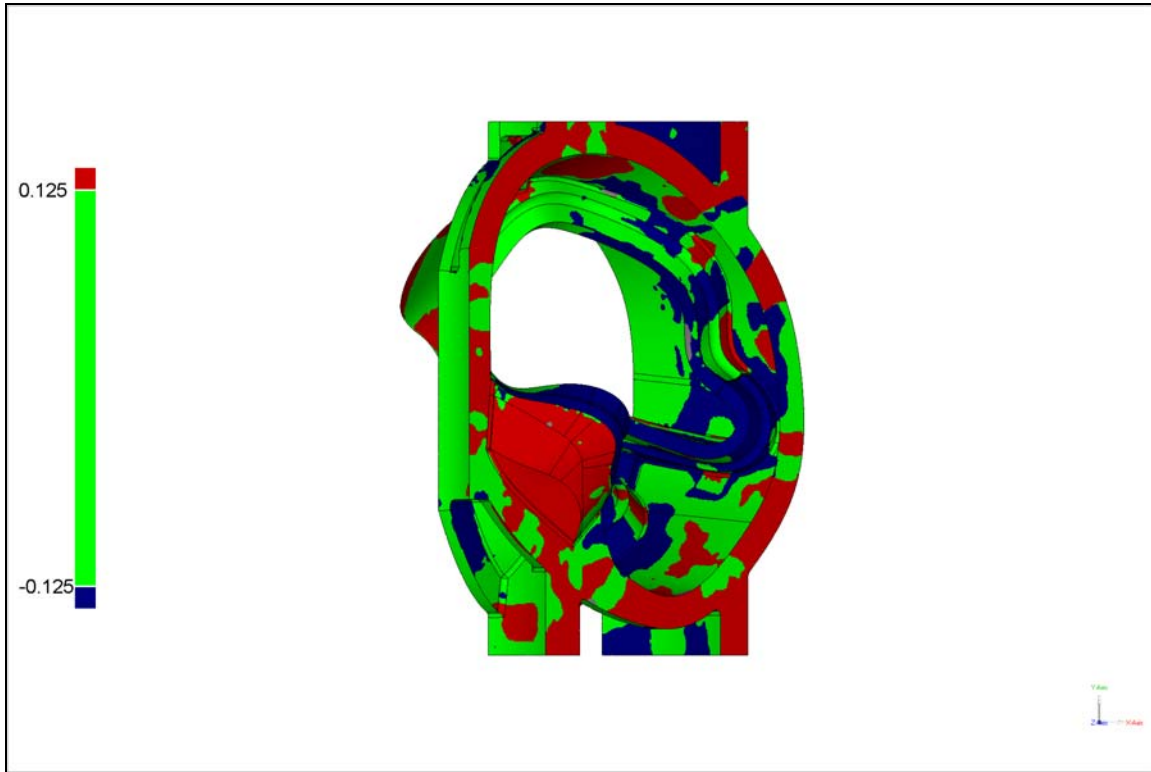

**Predefined: Back**

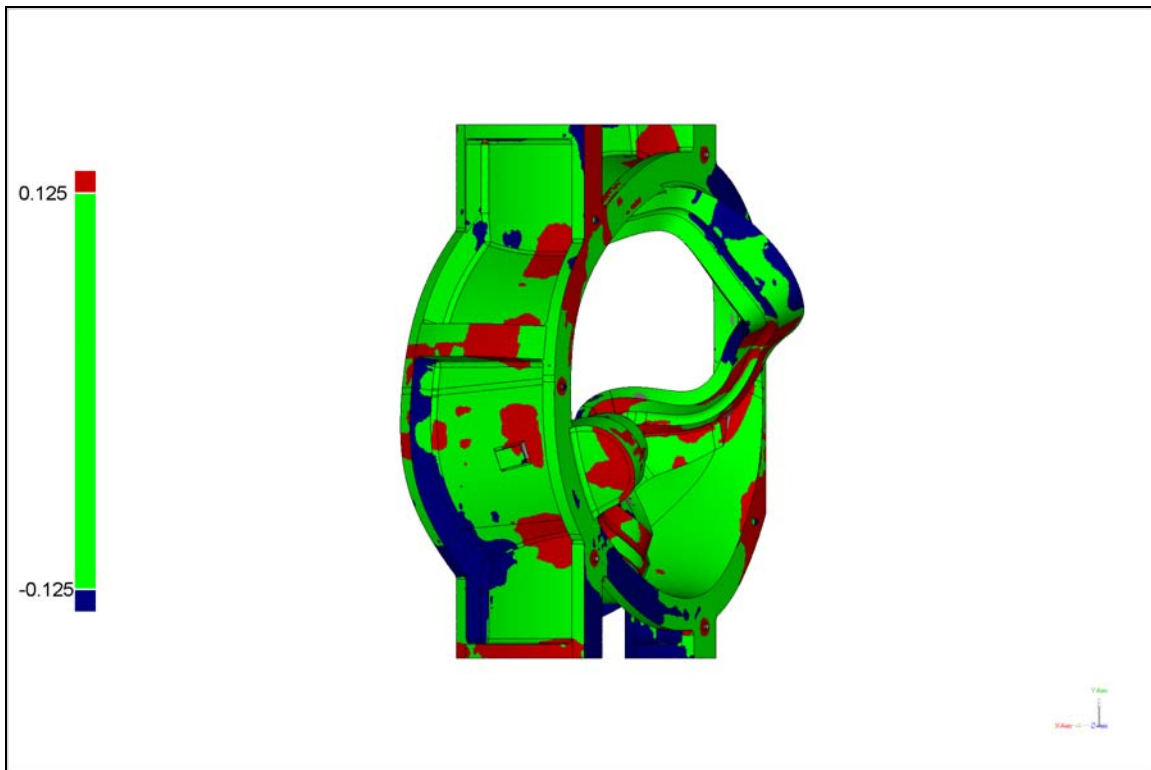



**Predefined: Left**

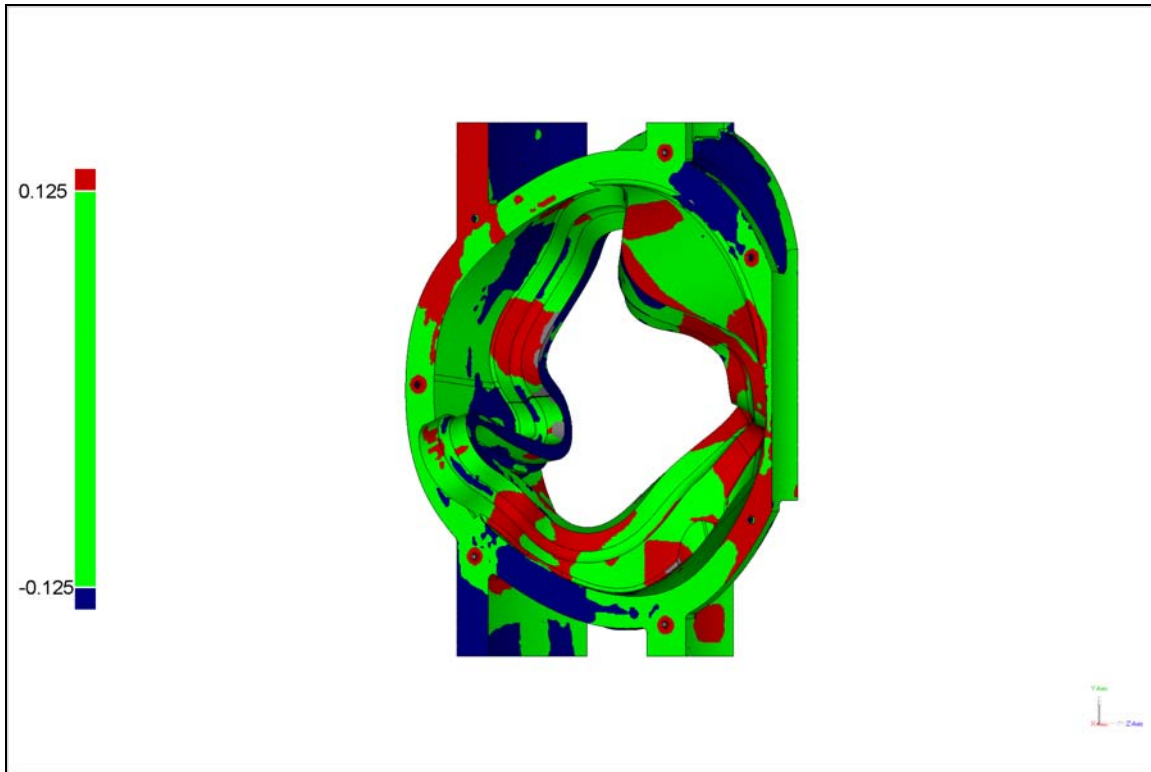

**Predefined: Right**

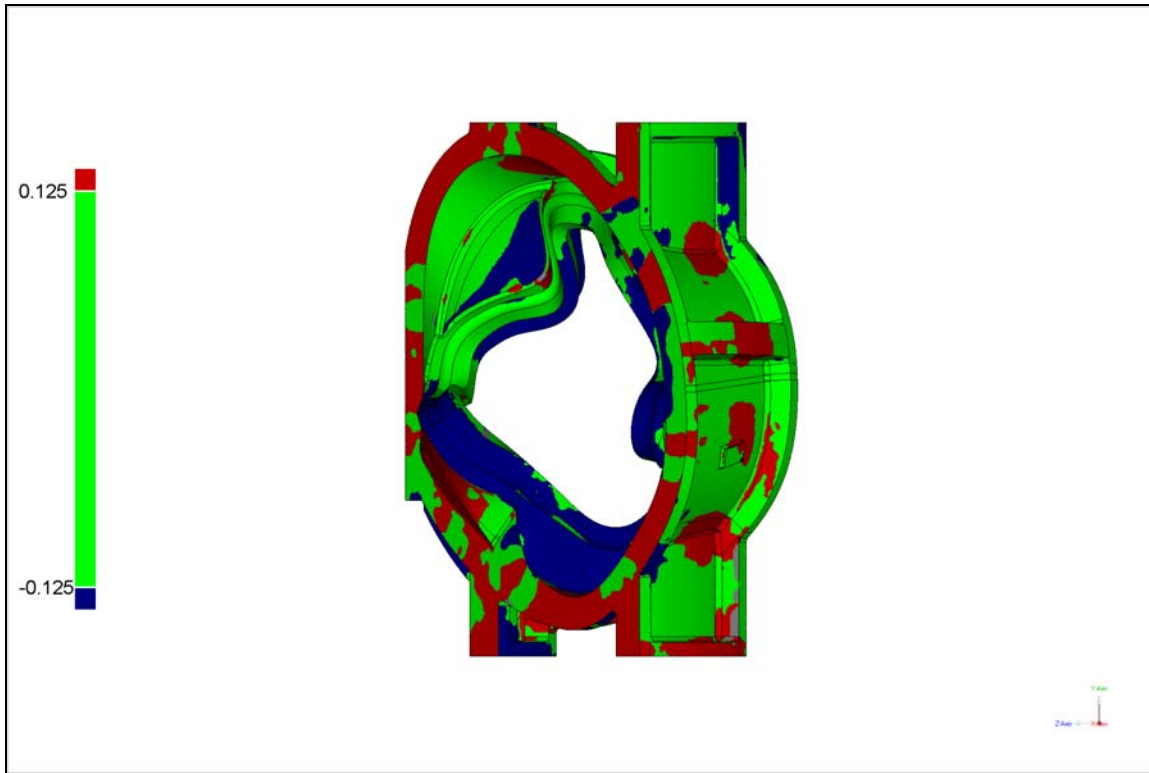

**Predefined: Top**

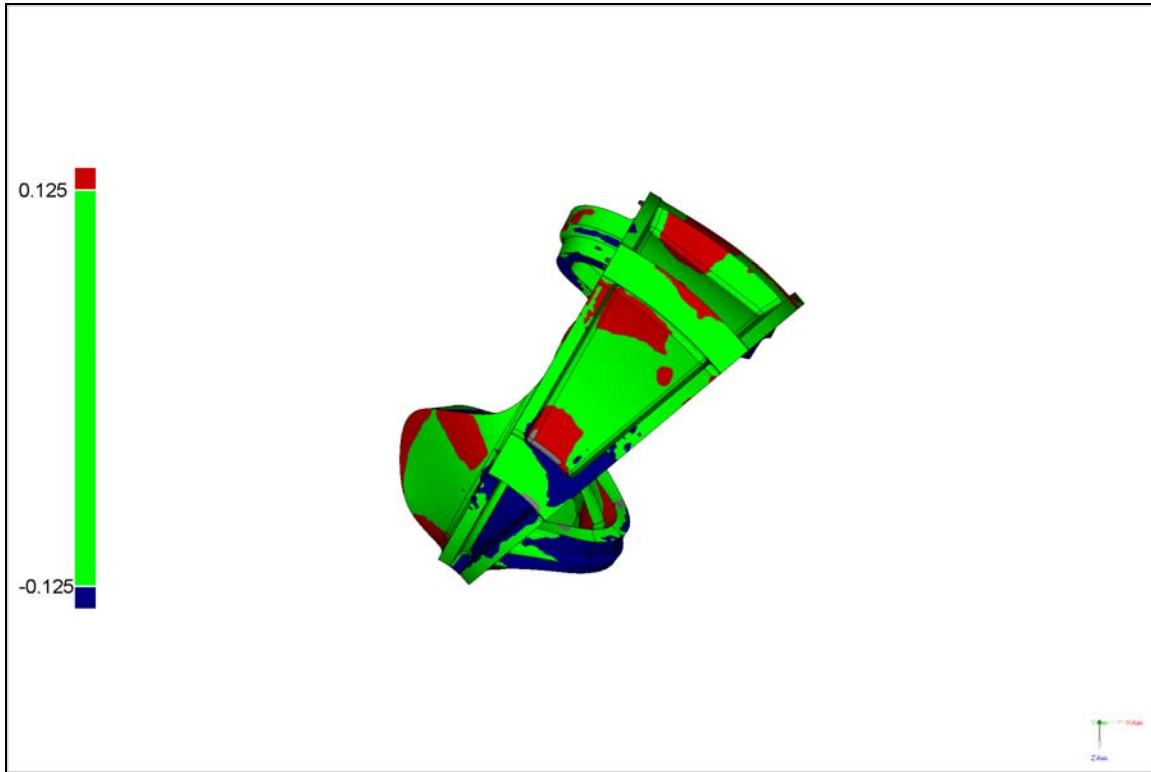

**Predefined: Bottom**

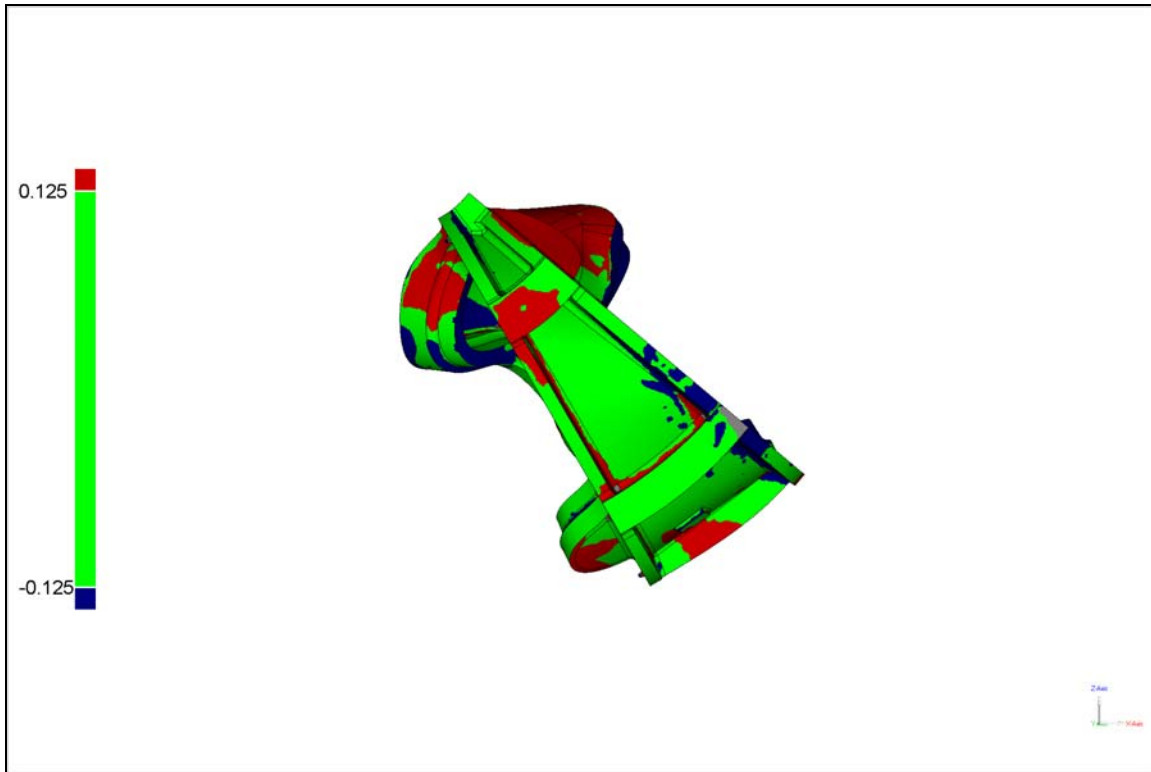

**Predefined: Isometric**

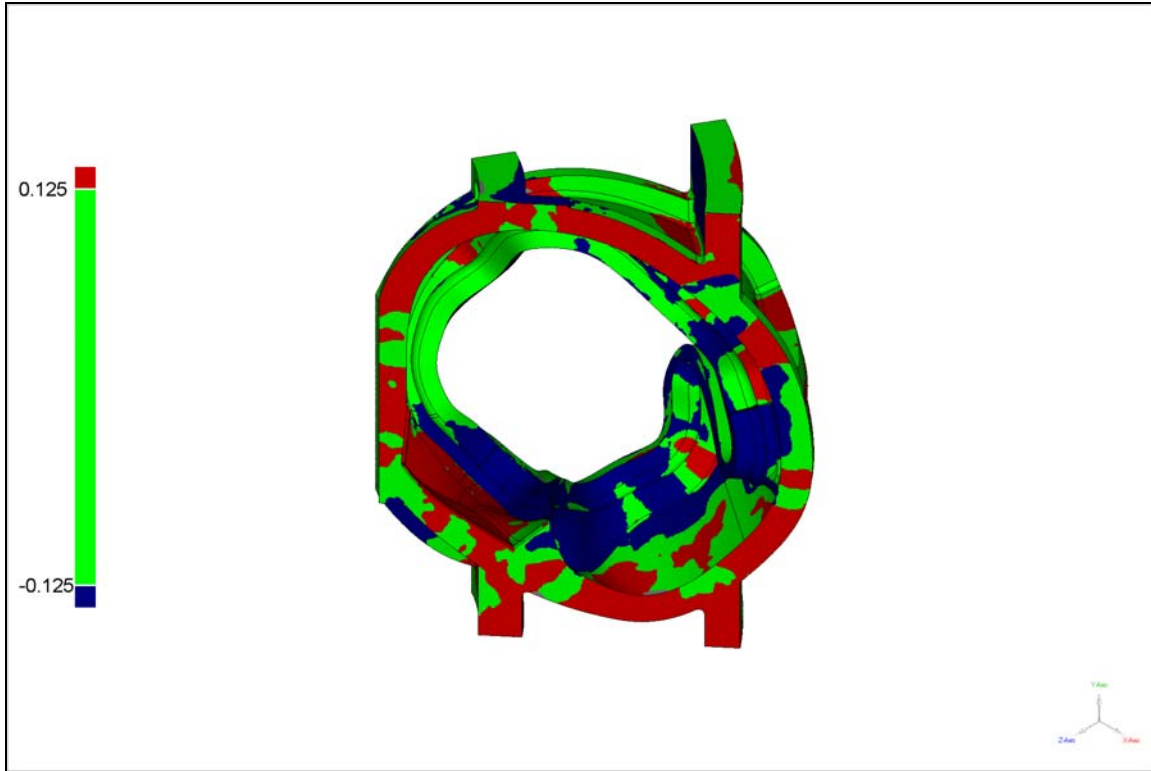

**Annotated: Annotation View Top**

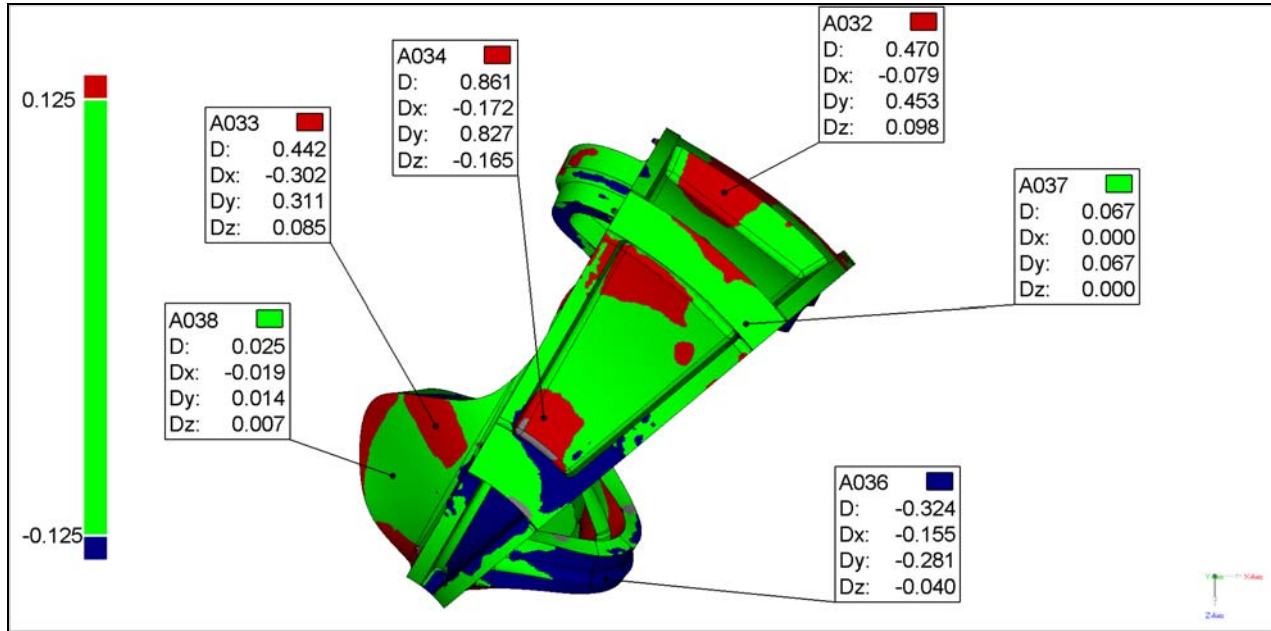

Units: in

Name	Dev	Status	Tol +	Tol -	Ref X	Ref Y	Ref Z	Dev Radius	Dev X	Dev Y	Dev Z	Test X	Test Y	Test Z
A032	0.470	FAIL	0.100	-0.100	54.294	11.519	-71.235	0.039	-0.079	0.453	0.098	54.215	11.972	-71.137
A033	0.442	FAIL	0.100	-0.100	11.899	30.670	-36.884	0.039	-0.302	0.311	0.085	11.597	30.981	-36.798
A034	0.861	FAIL	0.100	-0.100	27.749	40.157	-38.073	0.039	-0.172	0.827	-0.165	27.577	40.984	-38.237
A036	-0.324	FAIL	0.100	-0.100	36.863	-3.808	-14.297	0.039	-0.155	-0.281	-0.040	36.708	-4.090	-14.337
A037	0.067	PASS	0.100	-0.100	57.469	48.188	-51.942	0.039	0.000	0.067	0.000	57.469	48.255	-51.942
A038	0.025	PASS	0.100	-0.100	5.558	19.704	-29.553	0.039	-0.019	0.014	0.007	5.539	19.718	-29.546

**Annotated: Annotation View Bottom**

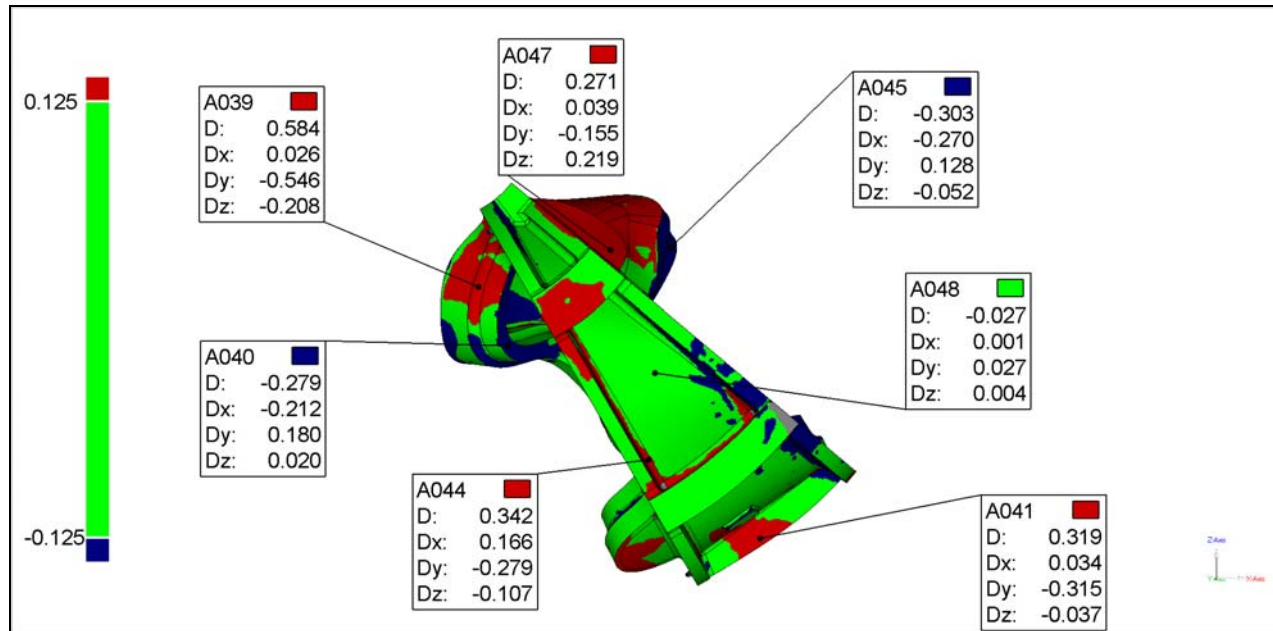

Units: in

Name	Dev	Status	Tol +	Tol -	Ref X	Ref Y	Ref Z	Dev Radius	Dev X	Dev Y	Dev Z	Test X	Test Y	Test Z
A039	0.584	FAIL	0.100	-0.100	7.399	10.856	-28.360	0.039	0.026	-0.546	-0.208	7.425	10.310	-28.567
A040	-0.279	FAIL	0.100	-0.100	12.590	14.051	-38.580	0.039	-0.212	0.180	0.020	12.377	14.230	-38.560
A041	0.319	FAIL	0.100	-0.100	56.713	6.078	-72.483	0.039	0.034	-0.315	-0.037	56.747	5.762	-72.520
A044	0.342	FAIL	0.100	-0.100	37.135	-31.757	-58.654	0.039	0.166	-0.279	-0.107	37.301	-32.037	-58.761
A045	-0.303	FAIL	0.100	-0.100	41.032	-8.625	-21.418	0.039	-0.270	0.128	-0.052	40.762	-8.497	-21.469
A047	0.271	FAIL	0.100	-0.100	30.470	-23.402	-21.884	0.039	0.039	-0.155	0.219	30.509	-23.558	-21.665
A048	-0.027	PASS	0.100	-0.100	38.270	-38.262	-43.393	0.039	0.001	0.027	0.004	38.270	-38.235	-43.390

**Annotated: Annotation View Left**

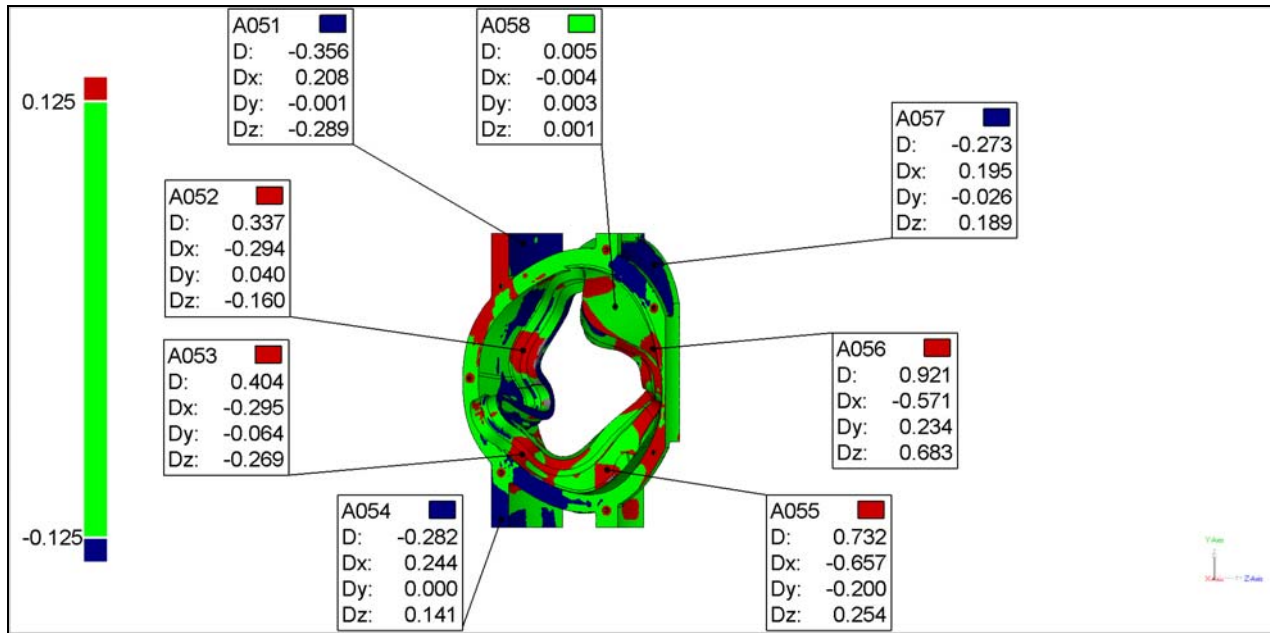

Units: in

Name	Dev	Status	Tol +	Tol -	Ref X	Ref Y	Ref Z	Dev Radius	Dev X	Dev Y	Dev Z	Test X	Test Y	Test Z
A051	-0.356	FAIL	0.100	-0.100	44.544	44.812	-61.169	0.039	0.208	-0.001	-0.289	44.752	44.811	-61.458
A052	0.337	FAIL	0.100	-0.100	53.352	9.964	-61.169	0.039	-0.294	0.040	-0.160	53.058	10.004	-61.329
A053	0.404	FAIL	0.100	-0.100	36.665	-24.158	-61.411	0.039	-0.295	-0.064	-0.269	36.371	-24.222	-61.680
A054	-0.282	FAIL	0.100	-0.100	38.553	-45.608	-68.276	0.039	0.244	0.000	0.141	38.798	-45.608	-68.135
A055	0.732	FAIL	0.100	-0.100	32.132	-29.208	-33.635	0.039	-0.657	-0.200	0.254	31.476	-29.408	-33.381
A056	0.921	FAIL	0.100	-0.100	7.357	10.477	-18.642	0.039	-0.571	0.234	0.683	6.786	10.711	-17.959
A057	-0.273	FAIL	0.100	-0.100	18.242	37.816	-18.201	0.039	0.195	-0.026	0.189	18.437	37.790	-18.012
A058	0.005	PASS	0.100	-0.100	8.213	24.147	-30.989	0.039	-0.004	0.003	0.001	8.209	24.149	-30.988



**Annotated: Annotation View Right**

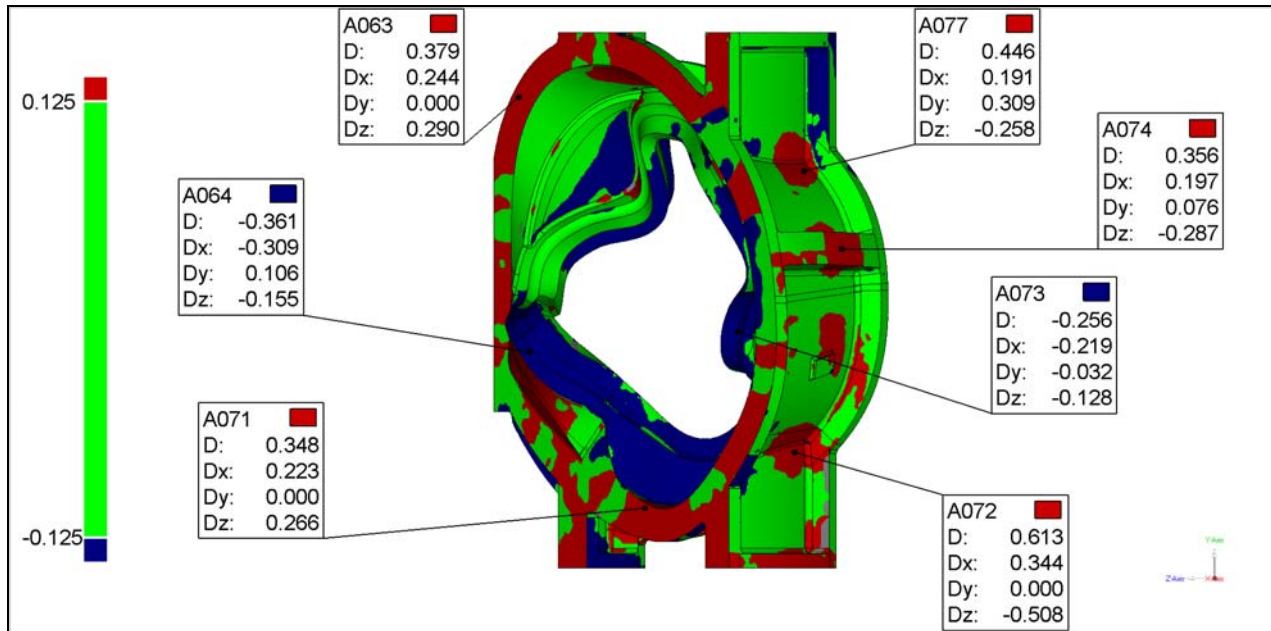

Units: in

Name	Dev	Status	Tol +	Tol -	Ref X	Ref Y	Ref Z	Dev Radius	Dev X	Dev Y	Dev Z	Test X	Test Y	Test Z
A063	0.379	FAIL	0.100	-0.100	18.531	36.560	-14.571	0.039	0.244	0.000	0.290	18.775	36.560	-14.280
A064	-0.361	FAIL	0.100	-0.100	40.476	-9.285	-16.439	0.039	-0.309	0.106	-0.155	40.167	-9.179	-16.594
A071	0.348	FAIL	0.100	-0.100	45.441	-37.411	-37.150	0.039	0.223	0.000	0.266	45.664	-37.411	-36.884
A072	0.613	FAIL	0.100	-0.100	43.968	-27.330	-64.018	0.039	0.344	0.000	-0.508	44.312	-27.330	-64.526
A073	-0.256	FAIL	0.100	-0.100	65.593	-5.551	-53.854	0.039	-0.219	-0.032	-0.128	65.374	-5.583	-53.983
A074	0.356	FAIL	0.100	-0.100	57.859	9.211	-72.488	0.039	0.197	0.076	-0.287	58.056	9.287	-72.775
A077	0.446	FAIL	0.100	-0.100	44.242	23.247	-65.712	0.039	0.191	0.309	-0.258	44.433	23.557	-65.970

**Annotated: Annotation View Front**

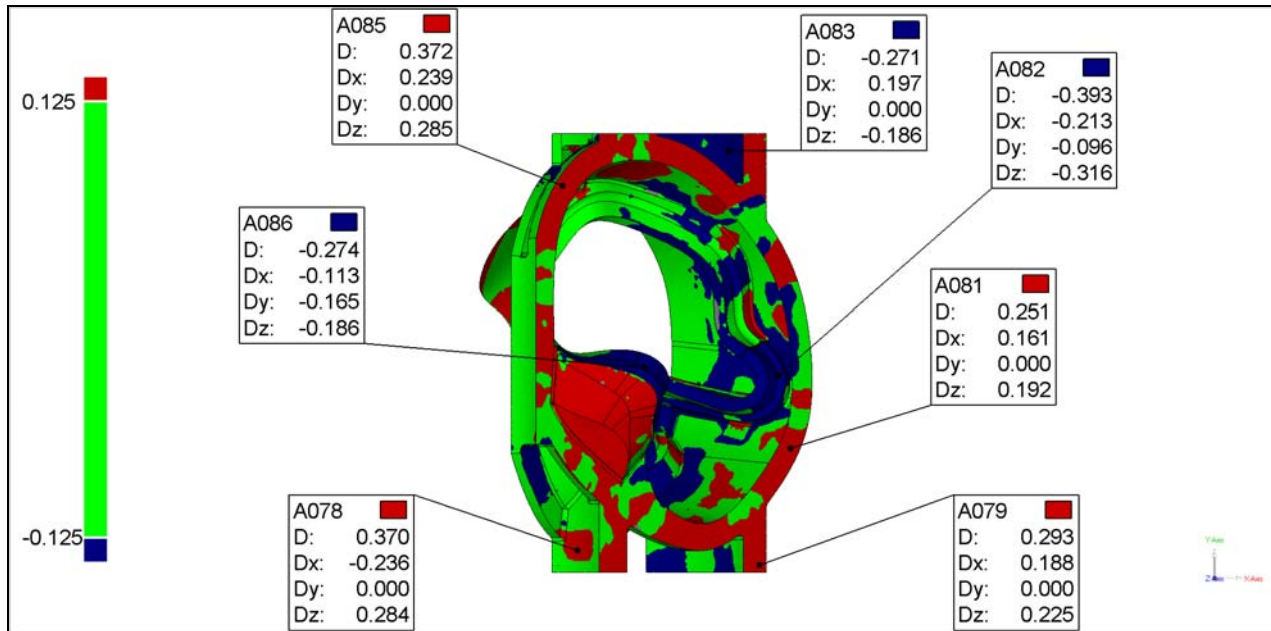

Units: in

Name	Dev	Status	Tol +	Tol -	Ref X	Ref Y	Ref Z	Dev Radius	Dev X	Dev Y	Dev Z	Test X	Test Y	Test Z
A078	0.370	FAIL	0.100	-0.100	22.125	-43.372	-26.471	0.039	-0.236	0.000	0.284	21.889	-43.372	-26.187
A079	0.293	FAIL	0.100	-0.100	62.028	-46.623	-51.069	0.039	0.188	0.000	0.225	62.216	-46.623	-50.844
A081	0.251	FAIL	0.100	-0.100	68.826	-20.908	-56.773	0.039	0.161	0.000	0.192	68.987	-20.908	-56.581
A082	-0.393	FAIL	0.100	-0.100	66.166	-4.946	-54.617	0.039	-0.213	-0.096	-0.316	65.953	-5.043	-54.932
A083	-0.271	FAIL	0.100	-0.100	55.230	44.415	-51.785	0.039	0.197	0.000	-0.186	55.427	44.415	-51.971
A085	0.372	FAIL	0.100	-0.100	18.874	36.730	-14.858	0.039	0.239	0.000	0.285	19.113	36.730	-14.573
A086	-0.274	FAIL	0.100	-0.100	36.904	-3.173	-15.496	0.039	-0.113	-0.165	-0.186	36.791	-3.338	-15.682

**Annotated: Annotation View Back**

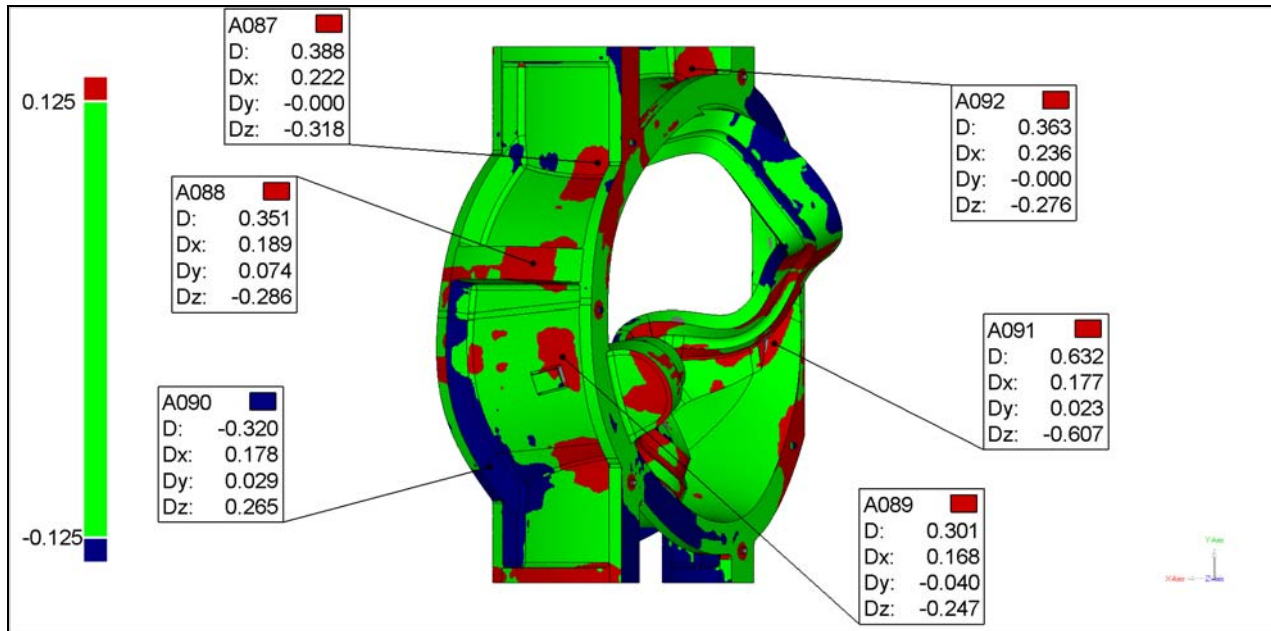

Units: in

Name	Dev	Status	Tol +	Tol -	Ref X	Ref Y	Ref Z	Dev Radius	Dev X	Dev Y	Dev Z	Test X	Test Y	Test Z
A087	0.388	FAIL	0.100	-0.100	44.656	27.300	-63.543	0.039	0.222	-0.000	-0.318	44.878	27.300	-63.861
A088	0.351	FAIL	0.100	-0.100	56.271	9.151	-73.572	0.039	0.189	0.074	-0.286	56.460	9.225	-73.859
A089	0.301	FAIL	0.100	-0.100	50.948	-7.547	-71.367	0.039	0.168	-0.040	-0.247	51.115	-7.587	-71.614
A090	-0.320	FAIL	0.100	-0.100	64.015	-27.391	-56.486	0.039	0.178	0.029	0.265	64.193	-27.363	-56.221
A091	0.632	FAIL	0.100	-0.100	12.954	-5.127	-14.409	0.039	0.177	0.023	-0.607	13.131	-5.105	-15.016
A092	0.363	FAIL	0.100	-0.100	27.716	44.240	-32.733	0.039	0.236	-0.000	-0.276	27.952	44.240	-33.009

**Annotated: Annotation View Isometric**

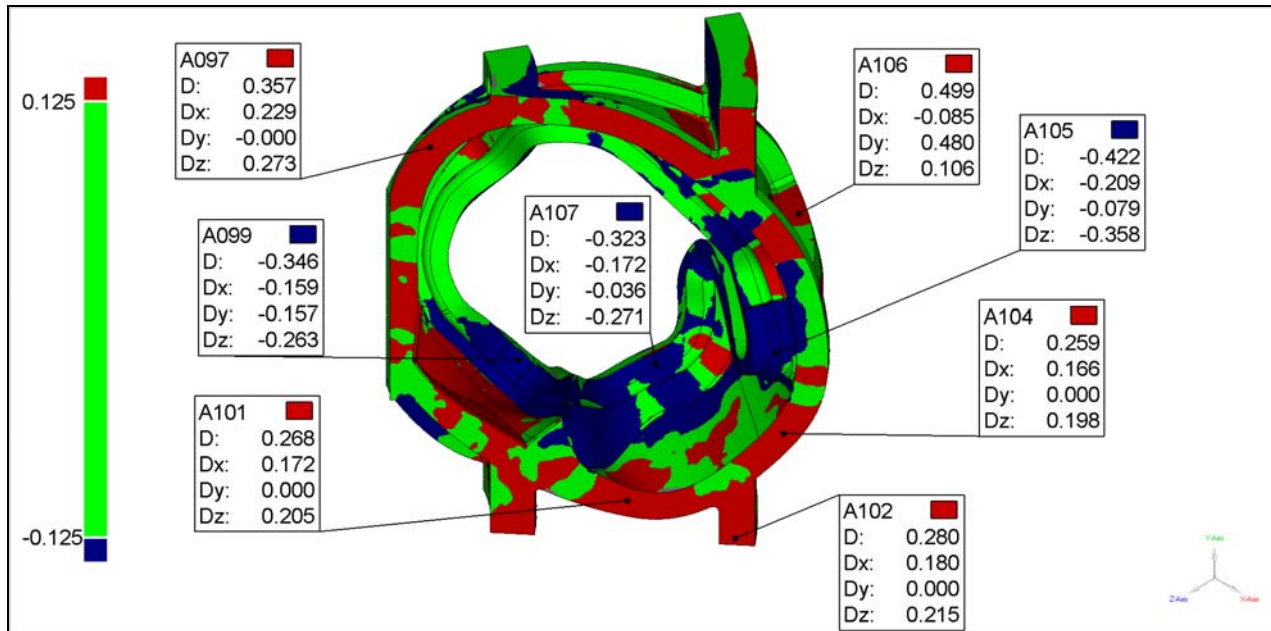

Units: in

Name	Dev	Status	Tol +	Tol -	Ref X	Ref Y	Ref Z	Dev Radius	Dev X	Dev Y	Dev Z	Test X	Test Y	Test Z
A097	0.357	FAIL	0.100	-0.100	18.638	35.973	-14.660	0.039	0.229	-0.000	0.273	18.868	35.973	-14.387
A099	-0.346	FAIL	0.100	-0.100	38.499	-2.006	-17.121	0.039	-0.159	-0.157	-0.263	38.340	-2.164	-17.385
A101	0.268	FAIL	0.100	-0.100	45.849	-39.638	-37.493	0.039	0.172	0.000	0.205	46.021	-39.638	-37.288
A102	0.280	FAIL	0.100	-0.100	60.736	-46.739	-49.985	0.039	0.180	0.000	0.215	60.917	-46.739	-49.770
A104	0.259	FAIL	0.100	-0.100	67.436	-23.082	-55.606	0.039	0.166	0.000	0.198	67.602	-23.082	-55.408
A105	-0.422	FAIL	0.100	-0.100	66.355	-5.353	-54.634	0.039	-0.209	-0.079	-0.358	66.146	-5.431	-54.992
A106	0.499	FAIL	0.100	-0.100	55.821	11.733	-70.985	0.039	-0.085	0.480	0.106	55.736	12.213	-70.879
A107	-0.323	FAIL	0.100	-0.100	35.687	-23.162	-54.842	0.039	-0.172	-0.036	-0.271	35.515	-23.198	-55.113



# Carondelet Division

Pevely, MO 63070  
(636) 475-2100

C-2 Doc Package  
Document # 25a

9/6/2005

## Annotated: All

Units: in

Name	Dev	Status	Tol +	Tol -	Ref X	Ref Y	Ref Z	Dev Radius	Dev X	Dev Y	Dev Z	Test X	Test Y	Test Z
A032	0.470	FAIL	0.100	-0.100	54.294	11.519	-71.235	0.039	-0.079	0.453	0.098	54.215	11.972	-71.137
A033	0.442	FAIL	0.100	-0.100	11.899	30.670	-36.884	0.039	-0.302	0.311	0.085	11.597	30.981	-36.798
A034	0.861	FAIL	0.100	-0.100	27.749	40.157	-38.073	0.039	-0.172	0.827	-0.165	27.577	40.984	-38.237
A036	-0.324	FAIL	0.100	-0.100	36.863	-3.808	-14.297	0.039	-0.155	-0.281	-0.040	36.708	-4.090	-14.337
A037	0.067	PASS	0.100	-0.100	57.469	48.188	-51.942	0.039	0.000	0.067	0.000	57.469	48.255	-51.942
A038	0.025	PASS	0.100	-0.100	5.558	19.704	-29.553	0.039	-0.019	0.014	0.007	5.539	19.718	-29.546
A039	0.584	FAIL	0.100	-0.100	7.399	10.856	-28.360	0.039	0.026	-0.546	-0.208	7.425	10.310	-28.567
A040	-0.279	FAIL	0.100	-0.100	12.590	14.051	-38.580	0.039	-0.212	0.180	0.020	12.377	14.230	-38.560
A041	0.319	FAIL	0.100	-0.100	56.713	6.078	-72.483	0.039	0.034	-0.315	-0.037	56.747	5.762	-72.520
A044	0.342	FAIL	0.100	-0.100	37.135	-31.757	-58.654	0.039	0.166	-0.279	-0.107	37.301	-32.037	-58.761
A045	-0.303	FAIL	0.100	-0.100	41.032	-8.625	-21.418	0.039	-0.270	0.128	-0.052	40.762	-8.497	-21.469
A047	0.271	FAIL	0.100	-0.100	30.470	-23.402	-21.884	0.039	0.039	-0.155	0.219	30.509	-23.558	-21.665
A048	-0.027	PASS	0.100	-0.100	38.270	-38.262	-43.393	0.039	0.001	0.027	0.004	38.270	-38.235	-43.390
A051	-0.356	FAIL	0.100	-0.100	44.544	44.812	-61.169	0.039	0.208	-0.001	-0.289	44.752	44.811	-61.458
A052	0.337	FAIL	0.100	-0.100	53.352	9.964	-61.169	0.039	-0.294	0.040	-0.160	53.058	10.004	-61.329
A053	0.404	FAIL	0.100	-0.100	36.665	-24.158	-61.411	0.039	-0.295	-0.064	-0.269	36.371	-24.222	-61.680
A054	-0.282	FAIL	0.100	-0.100	38.553	-45.608	-68.276	0.039	0.244	0.000	0.141	38.798	-45.608	-68.135
A055	0.732	FAIL	0.100	-0.100	32.132	-29.208	-33.635	0.039	-0.657	-0.200	0.254	31.476	-29.408	-33.381
A056	0.921	FAIL	0.100	-0.100	7.357	10.477	-18.642	0.039	-0.571	0.234	0.683	6.786	10.711	-17.959
A057	-0.273	FAIL	0.100	-0.100	18.242	37.816	-18.201	0.039	0.195	-0.026	0.189	18.437	37.790	-18.012
A058	0.005	PASS	0.100	-0.100	8.213	24.147	-30.989	0.039	-0.004	0.003	0.001	8.209	24.149	-30.988
A063	0.379	FAIL	0.100	-0.100	18.531	36.560	-14.571	0.039	0.244	0.000	0.290	18.775	36.560	-14.280
A064	-0.361	FAIL	0.100	-0.100	40.476	-9.285	-16.439	0.039	-0.309	0.106	-0.155	40.167	-9.179	-16.594
A071	0.348	FAIL	0.100	-0.100	45.441	-37.411	-37.150	0.039	0.223	0.000	0.266	45.664	-37.411	-36.884
A072	0.613	FAIL	0.100	-0.100	43.968	-27.330	-64.018	0.039	0.344	0.000	-0.508	44.312	-27.330	-64.526
A073	-0.256	FAIL	0.100	-0.100	65.593	-5.551	-53.854	0.039	-0.219	-0.032	-0.128	65.374	-5.583	-53.983
A074	0.356	FAIL	0.100	-0.100	57.859	9.211	-72.488	0.039	0.197	0.076	-0.287	58.056	9.287	-72.775
A077	0.446	FAIL	0.100	-0.100	44.242	23.247	-65.712	0.039	0.191	0.309	-0.258	44.433	23.557	-65.970
A078	0.370	FAIL	0.100	-0.100	22.125	-43.372	-26.471	0.039	-0.236	0.000	0.284	21.889	-43.372	-26.187
A079	0.293	FAIL	0.100	-0.100	62.028	-46.623	-51.069	0.039	0.188	0.000	0.225	62.216	-46.623	-50.844
A081	0.251	FAIL	0.100	-0.100	68.826	-20.908	-56.773	0.039	0.161	0.000	0.192	68.987	-20.908	-56.581
A082	-0.393	FAIL	0.100	-0.100	66.166	-4.946	-54.617	0.039	-0.213	-0.096	-0.316	65.953	-5.043	-54.932
A083	-0.271	FAIL	0.100	-0.100	55.230	44.415	-51.785	0.039	0.197	0.000	-0.186	55.427	44.415	-51.971
A085	0.372	FAIL	0.100	-0.100	18.874	36.730	-14.858	0.039	0.239	0.000	0.285	19.113	36.730	-14.573
A086	-0.274	FAIL	0.100	-0.100	36.904	-3.173	-15.496	0.039	-0.113	-0.165	-0.186	36.791	-3.338	-15.682
A087	0.388	FAIL	0.100	-0.100	44.656	27.300	-63.543	0.039	0.222	-0.000	-0.318	44.878	27.300	-63.861
A088	0.351	FAIL	0.100	-0.100	56.271	9.151	-73.572	0.039	0.189	0.074	-0.286	56.460	9.225	-73.859
A089	0.301	FAIL	0.100	-0.100	50.948	-7.547	-71.367	0.039	0.168	-0.040	-0.247	51.115	-7.587	-71.614
A090	-0.320	FAIL	0.100	-0.100	64.015	-27.391	-56.486	0.039	0.178	0.029	0.265	64.193	-27.363	-56.221
A091	0.632	FAIL	0.100	-0.100	12.954	-5.127	-14.409	0.039	0.177	0.023	-0.607	13.131	-5.105	-15.016
A092	0.363	FAIL	0.100	-0.100	27.716	44.240	-32.733	0.039	0.236	-0.000	-0.276	27.952	44.240	-33.009
A097	0.357	FAIL	0.100	-0.100	18.638	35.973	-14.660	0.039	0.229	-0.000	0.273	18.868	35.973	-14.387
A099	-0.346	FAIL	0.100	-0.100	38.499	-2.006	-17.121	0.039	-0.159	-0.157	-0.263	38.340	-2.164	-17.385
A101	0.268	FAIL	0.100	-0.100	45.849	-39.638	-37.493	0.039	0.172	0.000	0.205	46.021	-39.638	-37.288
A102	0.280	FAIL	0.100	-0.100	60.736	-46.739	-49.985	0.039	0.180	0.000	0.215	60.917	-46.739	-49.770
A104	0.259	FAIL	0.100	-0.100	67.436	-23.082	-55.606	0.039	0.166	0.000	0.198	67.602	-23.082	-55.408
A105	-0.422	FAIL	0.100	-0.100	66.355	-5.353	-54.634	0.039	-0.209	-0.079	-0.358	66.146	-5.431	-54.992
A106	0.499	FAIL	0.100	-0.100	55.821	11.733	-70.985	0.039	-0.085	0.480	0.106	55.736	12.213	-70.879
A107	-0.323	FAIL	0.100	-0.100	35.687	-23.162	-54.842	0.039	-0.172	-0.036	-0.271	35.515	-23.198	-55.113

## Carondelet Division

8600 Commercial Blvd. - Pevely, MO 63070 USA  
Phone: 636-479-4499 - Fax: 636-479-3399

## Material Test Report

### ENERGY INDUSTRIES OF OHIO

Purchase Order Number PPPL-FP-LTS-2 Heat Number 29198 Pour Date 4/28/2005  
Pattern Number SE-141-073 COIL C SHIM (-3 thru -6 Parts) Cert Number S73220-2 and  
SE-141-033 COIL A SHIM (-1 thru -6 Parts) Cert Number S76220-1  
CAF Metal Designation CF8MNMnMod  
Material Spec CF8MNMN MOD

Revised 9/24/05

Element	Min	Actual	Max
C	0.040	0.070	0.070
CR	18.000	18.100	18.500
MN	2.300	2.970	2.800
MO	2.100	2.450	2.500
N	0.240	0.255	0.280
NI	13.000	13.120	13.500
P*	0.000	0.013	0.035
S*	0.000	0.010	0.025
SI	0.000	0.700	0.700

MN & SI previously reported on CA 1308 and were accepted.

\*P & S taken from test from heat parts were poured from and analyzed by wet chemistry, ASTM E1019-03 for sulfur and Gravimetric for phosphorous.

This report covers the eleven castings poured from heat 29198. Only parts listed above however will be shipped for this order. Each casting has a unique number stamped in the part adjacent to the pattern number to differentiate the part and subsequent reporting that will be traced to the casting.

Specification limits have been updated to latest specification.

Respectfully Submitted,  
Charles A. Ruud  
Quality Assurance Manager

2

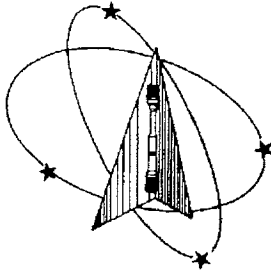

**Westmoreland Mechanical Testing & Research, Inc.**  
 P.O. Box 388  
 Westmoreland Drive  
 Youngstown, Pa. 15696-0388 U.S.A.  
 Telephone: 724-537-3131 Fax: 724-537-3151  
 Website: [www.wmtr.com](http://www.wmtr.com)  
 WMTR is a technical leader in the material testing industry.



621-01 & 621-02

June 20, 2005

**CERTIFICATION**

MetalTek International  
 The Carondelet Division  
 8600 Commercial Blvd.  
 I-55 Industrial Park  
 Pevelly, MO 63070-1528

Section 1 of 1  
 WMT&R Report No. 5-29403  
 Req. No. 5394

Attention: Rick Suria

Subject: All processes, performed upon the material as received, were conducted at WMT&R, Inc. in accordance with the WMT&R Quality Assurance Manual, Rev. 9, dated 4/1/2000.  
 The following tests were performed on this order: TENSILE

**TENSILE RESULTS: ASTM E21-03a**  
**SOAK TIME: 5 Minutes**  
**SPEED OF TESTING: 0.0030 in./in./min., 0.0500 in./min./in.**  
**MATERIAL: Metaltek CF8MMnMOD**

Sample	TestLog Number	Temp. °F	UTS ksi	0.2% YS ksi	Elong %	RA %	Modulus Msi	Ult. Load lbf	0.2% YLD. lbf	Orig. Dia. (in.)	Final Dia. (in.)	4D Orig. GL (in.)	4D Final GL (in.)	Orig. Area (sq. in.)	Machine Number	AIUR
29198 (1)	C03696	-320	166.1	96.0	57	62	28.6	33330	19260	0.5054	0.3103	2.00	3.14	0.20061359	M9	R
29198 (2)	C03697	-320	161.4	96.8	38	33	28.8	32390	19430	0.5055	0.4130	2.00	2.75	0.20069299	M9	R
29198 (3)	C03698	-320	165.0	92.6	62	62	27.6	33100	18581	0.5054	0.3109	2.00	3.23	0.20061359	M9	R

**DISPOSITION: Report**

AIUR: A=ACCEPTABLE, U=UNACCEPTABLE, R=REPORT

*Matthew J. Wojcik*  
 Roy E. Starr  
 Technical Services Manager / Tensile Supervisor  
 6-20-05  
 June 20, 2005

C-2 Doc Package  
 Document # 27

KNOWLEDGE OR WILLFULLY FALSIFYING OR CONCEALING A MATERIAL FACT ON THIS FORM OR MAKING FALSE, FICTITIOUS OR FRAUDULENT STATEMENTS OR REPRESENTATIONS HEREIN COULD CONSTITUTE A FELONY PUNISHABLE UNDER FEDERAL STATUTES. THIS CERTIFICATE OR REPORT SHALL NOT BE REPRODUCED EXCEPT IN FULL, WITHOUT THE WRITTEN APPROVAL OF WMT&R, INC.

*Testing Specialists for Aerospace, Automotive, and Material Testing Fields*  
 Locations in Youngstown, PA U.S.A. ~ Tel. (724) 537-3131 and  
 Banbury U.K. ~ Tel. +44 (0) 1295 261211



3  
C-2 Doc Package  
Document # 28

2810 Clark Avenue • St. Louis, MO 63103-2574 • (314) 531-8080 • FAX (314) 531-8085

**METALTEK INTERNATIONAL**  
8600 Commercial Blvd.  
Pevely, MO 63070

June 13, 2005  
Lab No. 05P-1739  
P.O. No. 12516  
Page 1 of 3

Attention: Chuck Ruud

**REPORT OF CHARPY IMPACT TEST**

**MATERIAL (SAMPLE ID):** HT # 29198  
**SPECIFICATION:** ASTM A 370-03a  
**SPECIMEN TYPE:** "A" Vee Notch  
**SPECIMEN SIZE:** 10 mm x 10 mm  
**TEMPERATURE OF TEST:** 293° K / 68° F  
**REQUIREMENTS:** 50 ft. / lb

BASE METAL	FOOT LBS.	LATERAL EXPANSION	% SHEAR
1-7	132	0.085	100
1-8	176	0.084	100
1-9	152	0.082	100
<b>Average</b>	<b>153</b>	<b>0.084</b>	<b>100</b>
BASE METAL	FOOT LBS.	LATERAL EXPANSION	% SHEAR
2-7	160	0.112	100
2-8	144	0.107	100
2-9	140	0.069	100
<b>Average</b>	<b>148</b>	<b>0.096</b>	<b>100</b>
BASE METAL	FOOT LBS.	LATERAL EXPANSION	% SHEAR
3-7	176	0.110	100
3-8	124	0.087	100
3-9	144	0.107	100
<b>Average</b>	<b>148</b>	<b>0.101</b>	<b>100</b>

Identification of tested specimen provided by client.

*[Signature]*  
Karl Schmitz, Director  
Materials Testing



Certificate No. 0397-01  
Certificate No. 0397-02

AN OFFICIAL COPY OF TEST REPORT WILL BE PROVIDED BY THIS LABORATORY ON REQUEST. DO NOT REPRODUCE  
NOT OFFICIAL WITHOUT THE RAISED SEAL OF ST. LOUIS TESTING LABORATORIES, INC.  
SEE REVERSE FOR CONDITIONS.







C-2 Doc Package  
Document # 28

2810 Clark Avenue • St. Louis, MO 63103-2574 • (314) 531-8080 • FAX (314) 531-8085

**METALTEK INTERNATIONAL**  
8600 Commercial Blvd.  
Pevely, MO 63070

June 13, 2005  
Lab No. 05p-1739  
P.O. No. 12516  
Page 2 of 3

Attention: Chuck Ruud

**REPORT OF CHARPY IMPACT TEST**

**MATERIAL (SAMPLE ID):** HT # 29198  
**SPECIFICATION:** ASTM A 370-03a  
**SPECIMEN TYPE:** "A" Vee Notch  
**SPECIMEN SIZE:** 10 mm x 10 mm  
**TEMPERATURE OF TEST:** 77° K / -321° F  
**REQUIREMENTS:** 35 ft / lb

BASE METAL	FOOT LBS.	LATERAL EXPANSION	% SHEAR
4-7	84	0.055	50
4-8	83	0.035	50
4-9	76	0.058	50
<b>Average</b>	81	0.049	50
BASE METAL	FOOT LBS.	LATERAL EXPANSION	% SHEAR
5-7	82	0.059	50
5-8	82	0.040	50
5-9	98	0.075	80
<b>Average</b>	87	0.058	60
BASE METAL	FOOT LBS.	LATERAL EXPANSION	% SHEAR
6-7	82	0.050	50
6-8	93	0.052	50
6-9	94	0.051	50
<b>Average</b>	90	0.051	50

Identification of tested specimen provided by client.

Karl Schmitz, Director  
Materials Testing



Certificate No. 0397-01  
Certificate No. 0397-02

AN OFFICIAL COPY OF TEST REPORT WILL BE PROVIDED BY THIS LABORATORY ON REQUEST. DO NOT REPRODUCE. NOT OFFICIAL WITHOUT THE RAISED SEAL OF ST. LOUIS TESTING LABORATORIES, INC. SEE REVERSE FOR CONDITIONS.





C-2 Doc Package  
Document # 28

2810 Clark Avenue • St. Louis, MO 63103-2574 • (314) 531-8080 • FAX (314) 531-8085

**METALTEK INTERNATIONAL**  
8600 Commercial Blvd.  
Pevely, MO 63070

June 13, 2005  
Lab No. 05P-1739  
P.O. No. 12516  
Page 3 of 3

Attention: **CHUCK RUUD**

### REPORT OF MECHANICAL TESTS

**SAMPLE ID:** 3 EA., 29198

Sample ID	Original Area Sq. inches	Reduced Area Sq. inches	Reduction in Area %	Modules of Elasticity	Yield Strength PSI	Tensile Strength PSI	Elongation (2.0" Gage Length)	
							in.	%
29298-1	0.1817	0.0855	52.9	21.2 Msi	40600	91900	1.00	50.0
29198-2	0.1825	0.0962	47.3	20.9 Msi	42700	88500	1.00	50.0
29198-3	0.1840	0.1170	36.4	21.1 Msi	39500	88300	0.97	48.5

Round, reduced section room temperature tensiles

Yield taken at .2% offset

Tested in accordance with ASTM A 370-03a

Identification of tested specimens provided by the client.

KS/tiv

Karl Schmitz, Director  
Materials Testing



Certificate No. 0397-01  
Certificate No. 0397-02

AN OFFICIAL COPY OF TEST REPORT WILL BE PROVIDED BY THIS LABORATORY ON REQUEST. DO NOT REPRODUCE.  
NOT OFFICIAL WITHOUT THE RAISED SEAL OF ST. LOUIS TESTING LABORATORIES, INC.  
SEE REVERSE FOR CONDITIONS

MEMBER  
**ACIL**



C-2 Doc Package  
Document # 29

### Carondelet Division

8600 Commercial Blvd. - Pevely, MO 63070 USA  
Phone: 636-479-4499 - Fax: 636-479-3399

### Final Inspection Report

Customer Name: ENERGY INDUSTRIES OF OHIO

Pattern: SE-141-073 COIL C SHIM

Order Number: PPPL-FP-LTS-2

ASTM Metal CF8MNMN MOD

Date 6/22/2005

Type Description	Cert Number	Procedure	Acceptance Criteria	Actual
Liquid Penetrant	S73220-2	CQP - 300 Rev 9	ASTM A903 Level II	Acceptable
Mag Perm	S73220-2	SOP Mag Perm 100 Rev 1	<1.02	Acceptable
Radiographic	S73220-2	Technique # 12726	MSS SP 54	Acceptable
Visual	S73220-2	CQP - 500 REV 4	ASTM A802 LEVEL 2	Acceptable

Respectfully Submitted,  
Charles A. Ruud  
Quality Assurance Manager

**Superior Quality Engineered Metal Products**

www.MetalTekInt.Com



C-2 Doc Package  
Document # 30

## Carondelet Division

8600 Commercial Blvd. - Pevely, MO 63070 USA  
Phone: 636-479-4499 - Fax: 636-479-3399

### Certificate of Conformance

ENERGY INDUSTRIES OF OHIO

Order Number PPPL-FP-LTS-2

Pattern SE-141-073 COIL C 2 SHIM S/ N 6

ASTM CF8MNMN MOD

Date 10/26/2005

Cert Number

S73220-2

Shim was not weld repaired. RT 2 on reader sheet refers to a number the x-ray department uses to track parts. It does not refer to a weld repair.

A handwritten signature in black ink, appearing to read "CARUUD", is positioned above the typed name.

Respectfully Submitted,  
Charles A. Ruud  
Quality Assurance Manager

***Superior Quality Engineered Metal Products***

www.MetalTekInt.Com

Corrective Action 1308  
Carondelet Division - CA / PA / RGA Database  
Corrective Action Type NCR  
Date 6/13/2005  
CA Originator C. Ruud  
Pattern Number: C and A Coil Shims 11 Pieces

**Description of Defect / Non-Conformance**

Chemistry for 11 shim castings is out of specification.

**Root Cause**

Chemistry specification was not changed in system and not communicated to Lab personnel.

**Corrective Action**

Specification was corrected in system and Lab personnel trained. Mag permeability was checked on the parts and are less than 1.02u.

**Verification of Corrective Action**

Chemistries were checked on subsequent parts and are within specification.

**Preventive Action**

Create Inspection and Test Plan summarizing all requirements.

**Estimated Completion Date**

6/15/05

**Actual Completion Date**

Complete.



Signed: C. Ruud

CC: Roger Broman, Barry Craig, Joe Edwards, E.J. Kubick

# MetalTek INTERNATIONAL

C-2 Doc Package  
Document # 32

7

## RADIOGRAPHIC INTERPRETATION REPORT

CUSTOMER <i>Energy Industries of Ohio</i>		PURCHASE ORDER NUMBER <i>PPPL FP-LTS-2</i>				DATE <i>6-23-05</i>		CONTROL NO. <i>40851</i>		PAGE <i>1 of 1</i>											
PART NO. <i>SE-141-073 coil C shim</i>		SPECIFICATION <i>E 186</i>		CLASS <i>III</i>		TOTAL PIECES <i>1</i>		PIECES ACCEPTED <i>1</i>													
RADIOGRAPHED BY: <i>Malych</i>				INTERPRETED BY: <i>Malych</i>				ASNT LEVEL <i>II</i>													
FILM TYPE <i>50</i>		MATERIAL <i>CF8 M N M N M N</i>		ISOTOPE <i>IRIDIUM 192 COBALT 60 V</i>				CODE <i>ASTM E94 ASME V MIL-STD-453</i>													
<i>-6 part</i>		VIEW		ACCEPT		REJECT		SHRINK		INCLUSION		POROSITY		LINEAR		SURFACE		LOF / LOOP		COMMENTS 	
<i>MS73220-2</i>		<i>RT-2</i>		<i>A 50</i>																	
		<i>B</i>																			
		<i>C</i>																			
		<i>D</i>																			
		<i>E</i>																			

RADIOGRAPHIC STANDARD SHOOTING SKETCH

Customer <u>Energy Industries of Ohio</u>	Pattern Number <u>SE-141-073</u>
Material <u>CF8MNMN-MOD</u>	Traceability Number <u>M573220</u>
Film Manufacturer <u>FUJI</u>	Source Number <u>CO60 247 CI</u>
IQI LEVEL <u>2-2T</u> From CQP 401 <input checked="" type="checkbox"/> Other (Specify, E.G. 2-4T, 2-1T) <u>N/A</u>	

Exposures (views)	A	B	C	D	E						
Thickness (IN.)	<u>3 3/8"</u>	→									
S/F Distance (IN.)	<u>24"</u>	→									
Penetrameter	<u>50</u>	→									
Time (MIN.)	<u>Calculate</u>	→									
Focal Spot (IN.)	<u>#1</u>	→									
Film Size (IN.)	<u>14X17</u>	→									
Screen Size (Pb) Front/Back	<u>,01</u>	→									
S.W.E./D.W.E.	<u>SWE</u>	→									
S.W.V./D.W.V.	<u>SWV</u>	→									
Film Type	<u>80</u>	→									
Acceptance Standard	<u>E186</u>	→									
Severity Level	<u>III</u>	→									

Shooting Sketch (Use Additional Pages as Needed)

use Spec. MSS-SP-54

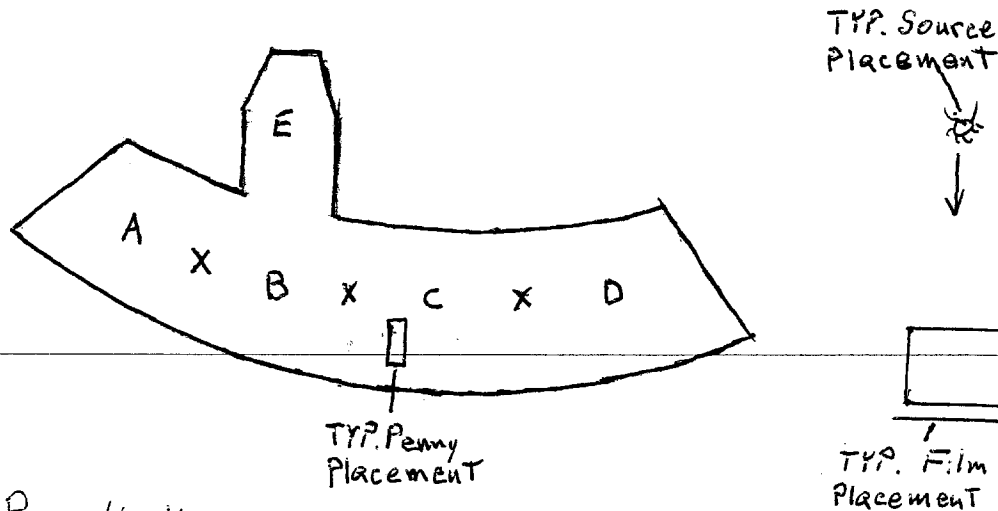

Technique Prepared By: Ron Kelley

Level: II

Date: 3-10-05

Technique Approved By: [Signature]

Level: III

Date: 3-10-05

C Shim

C-2 Doc Package  
Document # 33

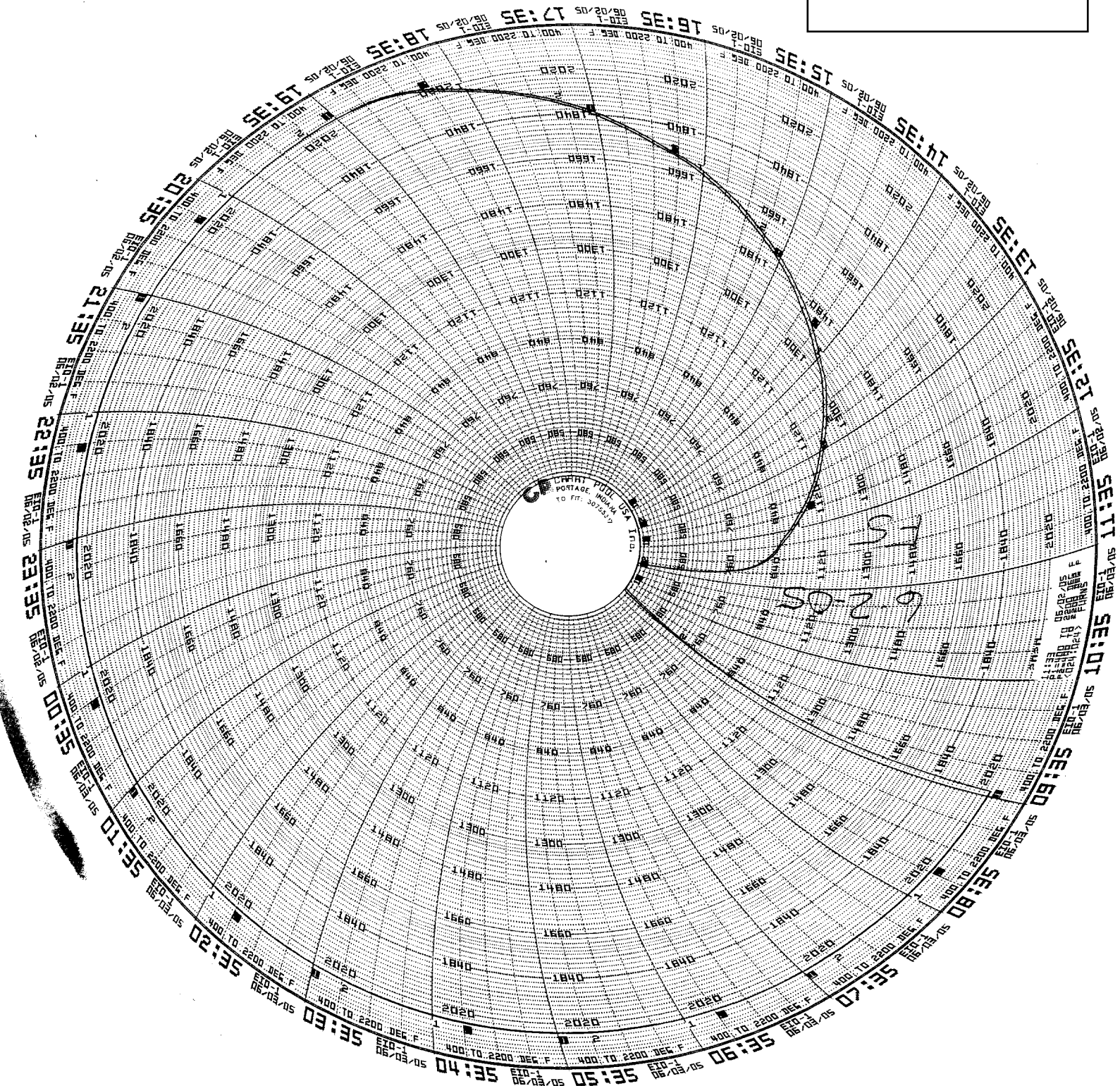

6209



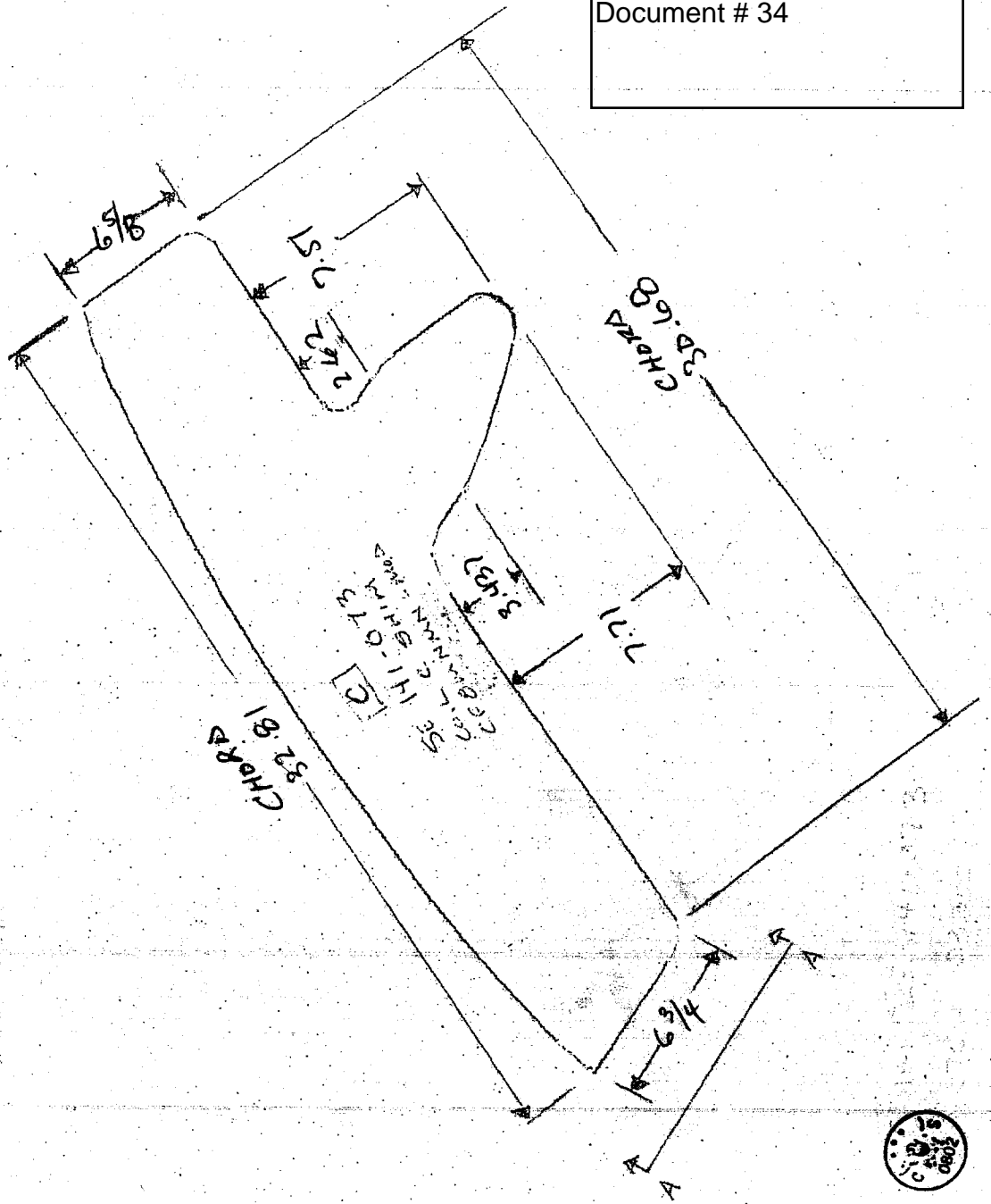

SECT A-A



SHIM SE 141-073 - 6  
SKETCH 6/23/05

*[Handwritten signature]*

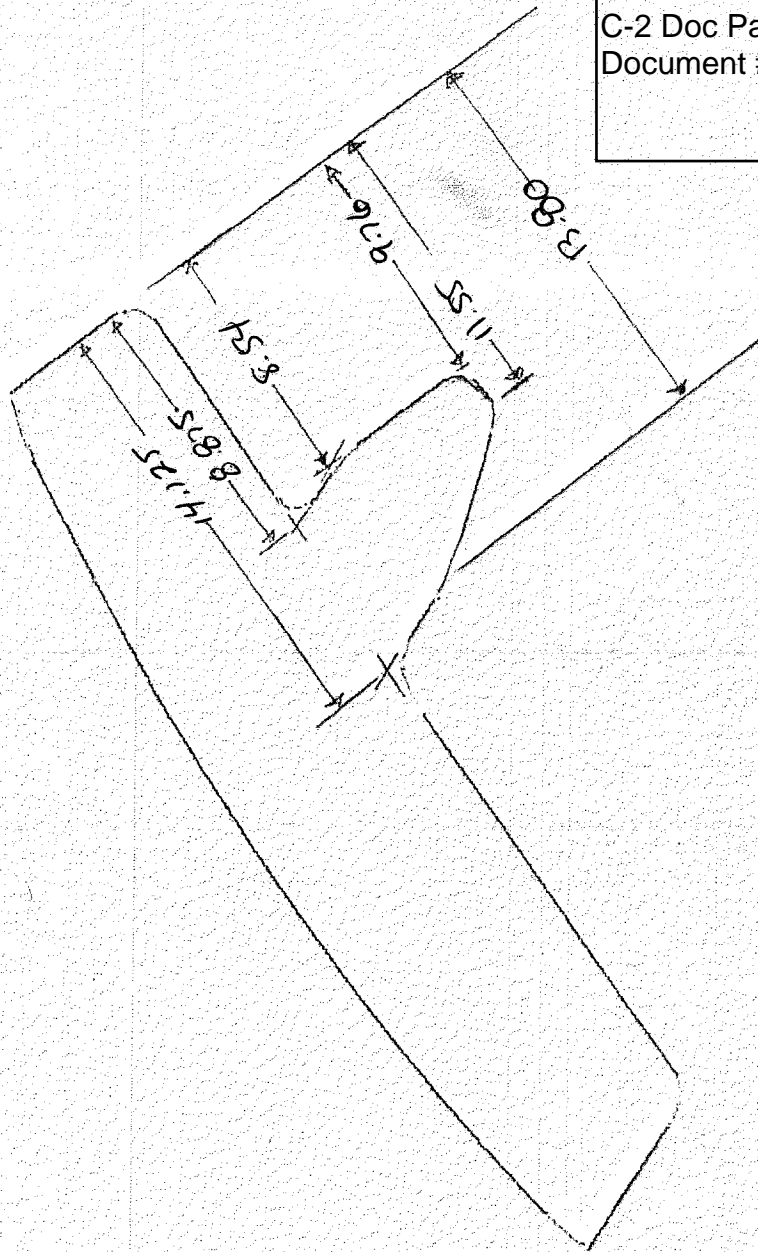

PAGE 2 OF 2  
SHIM DE 141-073-6  
SKETCH 6/23/05

OPER. #	STATION	DESCRIPTION OF PROCESS	Name	Date
10	QUALITY RELEASE	Keep all parts together. Sign and date each step when all 5 parts have been completed. REVIEW AND APPROVE MTS. RECEIVED APPROVAL FROM EIO ON <u>Date</u> FROM <u>12/15/04</u> SIGNED QUALITY MANAGER	<i>Chen</i>	<i>4/21/05</i>
20	PATTERN NPAT SOP 0100REV2	APPLY APPROPRIATE PART NUMBER, SERIAL NUMBER, FOUNDRY MARK, TO THE PATTERN.	<i>TB</i>	<i>4/22/05</i>
30	MOLD MOLD SOP 0400 REV 8 CALIBRATION PER MOLD SOP 0900 REV 5 PREPARATION PER MOLD SOP 1100R2/1200R2/1300R1 SAND TESTING PER MOLD SOP 1400R2/1500R3/1600R2	MOLD PER WORK INSTRUCTIONS IN MAPICS ROUTING AND SOPS REFERENCED. ENGINEER OF RECORD - ROGER BROMAN, CONSULT ON MOLD-RELATED CONCERNS. MOLD MATERIALS REQUIRED PER MAPICS BOM. NOTIFY ENGINEER OF ANY SUBSTITUTIONS.	<i>CR</i>	<i>4/22/05</i>
40	POUR MELT SOP 0100R5 MELT SOP 0700R2 MELT SOP 0600R2	METAL MUST BE AOD REFINED OR AOD INGOT. VIRGIN METAL ADDITIONS ALLOWED. RECORD POURING TEMPERATURE: <u>2825</u> CASTING Poured AT: <u>12-15-04</u> DATE: <u>4/28</u> HEAT #': <u>29198</u> ELAPSED POUR TIME: <u>44</u> KEEL BLOCKS Poured: <u>42</u> Sample from ladle to be analyzed for final chemical analysis and reported on material certifications. Sample Taken by: <u>SR</u> Analyzed: <u>G Hunt</u> Date: <u>4/28</u> <b>Note: Make 15 additional test bars for mechanical testing.</b>	<i>JG</i>	<i>4/28/05</i>
50	MELT SOP 0800R2	SHAKEOUT	<i>CA</i>	<i>4/29</i>
60	ARC RISE SOP 0100R1	REMOVE RISERS AS DIRECTED BY SUPERVISOR.	<i>BMW</i>	<i>4/10/05</i>
70	HEAT TREAT HEAT SOP 0103R5	SOLUTION ANNEAL. With C-1 Coil.	<i>DLS</i>	<i>6/22/05</i>

C-2 Doc Package  
Document # 35

80	PHYSICAL TESTING	OBTAIN TEST SPECIMENS AND SUBMIT FOR PHYSICAL TESTING. REPORT RESULTS AS PART OF STEP 480.	WT	4/29/05
90	GRIND GSW/A SOP 0100R3 GCHI SOP 0100R2	SWING GRIND TO REMOVE RISER REMAINS AND FLASH IF REQUIRED. CHIP AND HAND GRIND SURFACE OF PART AS REQUIRED.	CEG JF	6/16/05
100	SAND BLAST BLAS SOP 0100R6	SANDBLAST (REMOVE ALL BLAST MATERIAL FROM CASTING) SANDBLASTING WILL BE DONE USING RECYCLED SHARP ANGULAR AGGREGATE.	MW	6/16/05
110	VISUAL INSPECTION CQP-500 REV 4	VISUALLY INSPECT 100% OF COMPONENT ACCORDING TO ASTM A802 LEVEL 3 ALL CONDITIONS. IF OK CHECK HERE <input checked="" type="checkbox"/> . MARK AND REPAIR AT STEP 130.	VT- LEVEL II	3543 6-16-05
NOTICE	WITNESS NOTIFICATION	PROVIDE NOTICE TO EIO AND DCMA AT LEAST FIVE DAYS IN ADVANCE OF LP STEP. EIO NOTIFIED ON 6/10/05 DCMA NOTIFIED ON 6/10/05	Q ENG OR QA MGR	QAR 6-16-05
120	100% L.P. CQP 0300 REV 10	L.P. 100% OF COMPONENT. ACCEPTANCE PER ASTM A903. ACCEPTANCE CRITERIA- LEVEL 2. IF OK CHECK HERE <input checked="" type="checkbox"/> . IF REJECTED CHECK HERE <input type="checkbox"/> . MARK AND REPAIR AT STEP 120.	LP- LEVEL II	SJL3 6-16-05
130	WELD SOP 0100 REV 7	EXCAVATE ANY DEFECTS FOUND DURING 100% VISUAL AND LP INSPECTION.	CAF	4/20
140	L.P. EXCAVATION CQP-300 REV 10	L.P. ALL EXCAVATIONS PRIOR TO WELDING TO ENSURE REMOVAL OF DEFECT. ACCEPTANCE PER A903. ACCEPTANCE CRITERIA- LEVEL 2. <i>All defects ground out</i>	LP- LEVEL II	D.F. 4/23/05
150	SAND BLAST BLAS SOP 0100R6	SANDBLAST (REMOVE ALL BLAST MATERIAL FROM CASTING) SANDBLASTING WILL BE DONE USING RECYCLED SHARP ANGULAR AGGREGATE.	MW	6/23/05
160	WELD MAP	MAP ALL WELDS WITH DIGITAL PHOTO/MAPS. SERIALIZE DEFECTS ON CASTING. USE SCALE IN PHOTOS AND DOCUMENT SIZE. THIS IS TO BE PERFORMED BY SUPERVISOR, INSPECTION LEAD MAN OR THEIR DESIGNEE. FILE WITH QA. USE YELLOW MARKER. MUST SEND REPORT ON ALL WELDS OVER 10% OF NOMINAL WALL THICKNESS TO CUSTOMER. DEFECTS > 10% YES <input type="checkbox"/> , REPORT SENT BY <input type="checkbox"/> DATE <input type="checkbox"/> DEFECTS < 10% <input type="checkbox"/> SIGN BY QA ENG.	Dot Reground	
NOTICE	WITNESS NOTIFICATION	PROVIDE NOTICE TO EIO AND DCMA AT LEAST FIVE DAYS IN ADVANCE OF XRAY AND LAYOUT STEPS. EIO NOTIFIED ON 6/10/05 DCMA NOTIFIED ON 6/20/05	Q ENG OR QA MGR	QAR

**FIVE PARTS KEEP TOGETHER**

**-6**

Energy Industries of Ohio  
Manufacturing and Test Sequence (MTS) Coill C Shim

CO# 40851, Pattern SE 141-073

~~X~~ MS73220-2

Dated December 14, 2004

Revision: Original

Page 3 of 6

Dated Issued: 4-27-05

170	CAF X-RAY CQP 401 REV 5	X-RAY PER TECHNIQUE: To be determined. USE CALIBRATED DENSITOMETER FOR DENSITY VERIFICATION. ATTACH TECHNIQUE, READER SHEET FOR ALL RADIOGRAPHS. MUST INDICATE RADIOGRAPHER AND ASNT CERTIFICATION LEVEL ON READER SHEET.	RT - LEVEL II	6/23/05
180	X-RAY CQP 401 REV 5	X-RAY INTERPRETATION. ACCEPTANCE MSS SP 54. ATTACH TECHNIQUE, READER SHEET FOR ALL RADIOGRAPHS. MUST INDICATE RADIOGRAPHER AND ASNT CERTIFICATION LEVEL ON READER SHEET. IF OK CHECK HERE <input checked="" type="checkbox"/> AND SEND TO STEP 310. REJECTED CHECK HERE <input type="checkbox"/> MARK UP DEFECTS AND SEND THE CASTING TO STEP 200.	RT - LEVEL II	6/23/05
190	LAYOUT	INSPECT CASTING TO VERIFY DIMENSIONS. THIS MAY BE PERFORMED BEFORE OR AFTER STEP 180. DIMENSIONED <u>35</u> DATE <u>6/23/05</u> RELEASED _____ (ENGINEER ONLY)	RB	6/23/05
200	WELD SOP 0100 REV 7	EXCAVATE ANY DEFECTS FOUND DURING RADIOGRAPHY.		
210	L.P. EXCAVATION CQP-300 REV 10	L.P. ALL EXCAVATIONS PRIOR TO WELDING TO ENSURE REMOVAL OF DEFECT. ACCEPTANCE PER A903. ACCEPTANCE CRITERIA- LEVEL 2.	LP - LEVEL II	
220	WELD MAP	MAP ALL WELDS WITH DIGITAL PHOTO/MAPS. SERIALIZE DEFECTS ON CASTING. USE SCALE IN PHOTOS AND DOCUMENT SIZE. THIS IS TO BE PERFORMED BY SUPERVISOR, INSPECTION LEAD MAN OR THEIR DESIGNEE, FILE WITH QA. MUST SEND REPORT ON ALL WELDS OVER 10% OF NOMINAL WALL THICKNESS TO CUSTOMER. DEFECTS > 10% YES _____, REPORT SENT BY _____ DATE _____ DEFECTS < 10% _____ SIGN BY QA ENG. _____		
NOTICE	WITNESS NOTIFICATION	PROVIDE NOTICE TO EIO AND DCMA AT LEAST FIVE DAYS IN ADVANCE OF WELD STEP. EIO NOTIFIED ON _____ DCMA NOTIFIED ON _____	Q ENG OR QA MGR	
230	QA APPROVAL HOLD POINT	QA TO APPROVE ELECTRODE PRIOR TO USE. PROCEDURE USED: _____ MATERIAL USED: _____ QUALITY ENG. Name: _____ Date: _____		
240	WELD SOP 0100 REV 7	WELD REPAIR DEFECTS AS MARKED. FOR WELDS < 2" - WPS 10-SMAW-CF88MNMN MOD REV 1 FOR WELDS < 8" - WPS 15-GMAW-CF88MNMN MOD REV 2		
250	GRIND GCHI SOP 0100R2	HAND GRIND WELDS.		



WA

C-2 Doc Package  
Document # 35

**FIVE PARTS KEEP TOGETHER**

CO# 40851, Pattern SE 141-073 - *2* MS73220-2

Manufacturing and Test Sequence (MTS) Coill C Shim  
 Dated December 14, 2004 Revision: Original

Page 4 of 6

Dated Issued: 4-27-05

Energy Industries of Ohio

260	L.P. WELD COP 0300 REV 10	L.P. WELD REPAIRS ACCEPTANCE PER ASTM A903. ACCEPTANCE CRITERIA-LEVEL 2. IF OK CHECK HERE _____ WASH AND SEND TO STEP 300. IF REJECTED CHECK HERE _____ AND RETURN TO STEP 220.	LP - LEVEL II	
	REPEAT	REPEAT STEPS 220 TO 260 AS REQUIRED TILL CLEAR THROUGH VISUAL INSPECTION & PENETRANT INSPECTION. DOCUMENT REWORK ON A SUPPLEMENTAL MTS	QA ENG.	
270	TEST MAG PERM SOP MAG PERM 100, REV 1	TEST MAG PERMEABILITY REPAIR AREAS. RECORD ON WELD MAP LIST. TEST AT LEAST 5 POINTS PER WELD. ACCEPTANCE 1.02. IF OK CHECK HERE <input checked="" type="checkbox"/> AND GO TO STEP 290. IF REJECTED CHECK HERE _____.	<i>OK</i>	<i>6/23/05</i>
280	GRIND GCHI SOP 0100R2	GRIND AREAS OF NON COMPLIANCE AND RETURN TO STEP 270. REPEAT UNTILL COMPLIANCE IS ACHIEVED.		<i>OK</i>
290	CAP X-RAY DEFECTS REPAIRED BY WELDING COP 401 REV 5	X-RAY PER TECHNIQUE: To be determined. USE CALIBRATED DENSITOMETER FOR DENSITY VERIFICATION. ATTACH TECHNIQUE, READER SHEET FOR ALL RADIOGRAPHS. MUST INDICATE RADIOGRAPHER AND ASNT CERTIFICATION LEVEL ON READER SHEET.	RT - LEVEL II	
300	X-RAY COP 401 REV 5	X-RAY INTERPRETATION. ACCEPTANCE MSS SP 54. ATTACH TECHNIQUE, READER SHEET FOR ALL RADIOGRAPHS. MUST INDICATE RADIOGRAPHER AND ASNT CERTIFICATION LEVEL ON READER SHEET. IF OK CHECK HERE _____ AND SEND TO STEP 310. IF REJECTED CHECK HERE _____ MARK UP DEFECTS AND SEND THE CASTING TO STEP 200.	RT - LEVEL II	
	REPEAT	REPEAT STEPS 200 TO 300 AS REQUIRED TILL WELDS CLEAR X-RAY. DOCUMENT REWORK ON A SUPPLEMENTAL MTS	QA ENG.	
310	SAND BLAST BLAS SOP 0100R6	SANDBLAST (REMOVE ALL BLAST MATERIAL FROM CASTING) SANDBLASTING WILL BE DONE USING RECYCLED SHARP ANGULAR AGGREGATE.		<i>OK</i>
	NOTICE	PROVIDE NOTICE TO EIO AND DCMA AT LEAST FIVE DAYS IN ADVANCE OF VISUAL AND LP STEPS. EIO NOTIFIED ON <i>6/20/05</i> DCMA NOTIFIED ON <i>6/20/05</i>	Q ENG OR QA MGR	<i>OK</i>
320	FINAL VISUAL INSPECTION COP-500 REV 4	VISUALLY INSPECT 100% OF COMPONENT ACCORDING TO ASTM A802 LEVEL II CONDITIONS. IF OK CHECK HERE <input checked="" type="checkbox"/> IF REJECTED CHECK HERE _____ MARK AND REPAIR AT STEP 340.	VT - LEVEL II	<i>OK</i> <i>6-24-05</i>

C-2 Doc Package  
 Document # 35



Energy Industries of Ohio

330	FINAL L.P. COP 0300 REV 10	FINAL L.P. 100% OF COMPONENT. ACCEPTANCE PER ASTM A903. ACCEPTANCE CRITERIA- LEVEL 1 FOR HIGH STRESSED AREAS, LEVEL 2 FOR ALL OTHER AREAS. SEE LP DRAWING. IF OK CHECK HERE _____ WASH AND SEND TO STEP 410. IF REJECTED CHECK HERE _____	LP - LEVEL II	
340	WELD SOP 0100 REV 7	EXCAVATE ANY DEFECTS FOUND DURING FINAL PENETRANT INSPECTION.	N/A	LP OK
350	L.P. EXCAVATION COP-300 REV 10	L.P. ALL EXCAVATIONS PRIOR TO WELDING TO ENSURE REMOVAL OF DEFECT. ACCEPTANCE PER A903.	LP - LEVEL II	
370	WELD MAP	MAP ALL WELDS WITH DIGITAL PHOTO/MAPS. SERIALIZE DEFECTS ON CASTING, USE SCALE IN PHOTOS AND DOCUMENT SIZE. THIS IS TO BE PERFORMED BY SUPERVISOR, INSPECTION LEAD MAN OR THEIR DESIGNEE. FILE WITH QA. MUST SEND REPORT ON ALL WELDS OVER 10% OF NOMINAL WALL THICKNESS TO CUSTOMER. NOMINAL WALL THICKNESS TO CUSTOMER. DEFECTS > 10% YES _____, REPORT SENT BY _____ DATE _____ DEFECTS < 10% _____ SIGN BY QA ENG.		
380	WELD SOP 0100 REV 7	WELD REPAIR DEFECTS AS MARKED. FOR WELDS < 2" - WPS 10-SMAW-CF8MNMN MOD REV 1 FOR WELDS < 8" - WPS 15-GMAW-CF8MNMN MOD REV 2		
390	GRIND GCHI SOP 0100 REV 2	HAND GRIND WELDS.		
400	L.P. WELDS COP 0300 REV 10	L.P. WELD REPAIRS ACCEPTANCE PER ASTM A903. IF OK CHECK HERE _____ WASH AND SEND TO STEP 460. IF REJECTED CHECK HERE _____ AND RETURN TO STEP 390.	LP - LEVEL II	
	REPEAT	REPEAT STEPS 390 TO 410 AS REQUIRED TILL WELDS CLEAR FINAL LIQUID PENETRANT INSPECTION. DOCUMENT REWORK ON A SUPPLEMENTAL MTS	QA ENG. ↙	
410	TEST MAG PERM SOP MAG PERM 100, REV 1	TEST MAG PERMEABILITY REPAIR AREAS. RECORD ON WELD MAP LIST. TEST AT LEAST 5 POINTS PER WELD. ACCEPTANCE 1.02. IF OK CHECK HERE _____ AND GO TO STEP 430.	N/A SEE STEP 270	

420	GRIND GCHI SOP 0100R2	GRIND AREAS OF NON COMPLIANCE AND RETURN TO STEP 420. REPEAT UNTILL COMPLIANCE IS ACHIEVED.	N/A	
NOTICE	WITNESS NOTIFICATION	PROVIDE NOTICE TO EIO AND DCMA AT LEAST FIVE DAYS IN ADVANCE OF MAG PERM STEP. EIO NOTIFIED ON _____ DCMA NOTIFIED ON _____	Q ENG OR QA MGR	
430	FINAL MAG PERM INSPECTION SOP MAG PERM 100, REV 1	PERFORM MAG PERM TESTING WITH SEVRIN GAUGE. ACCEPTANCE 1.02. CHECK THE ENTIRE SURFACE ON A 6"BY6" GRID. REPORT RESULTS. USE A 6" SQUARE BLOCK TO INDICATE TEST LOCATIONS AND RECORD RESULTS. COMPLIANT AREAS WILL NOT BE MARKED. MARK NONCOMPLIANT AREAS WITH AN "X" FOR REPAIR. OK CHECK HERE _____ AND GO TO STEP 470. IF REJECTED CHECK HERE _____	SEE STEP 270	
440	GRIND GCHI SOP 0100 REV 2	HAND GRIND WITH SUITABLE CONE OR OTHER SIMILAR GRINDER AS REQUIRED TO ENSURE REMOVAL OF MATERIAL TO ACHIEVE MAG PERM REQUIREMENT. CIRCLE AREA REMEDIATE FOR RETEST.	N/A	
450	RETEST MAG PERM SOP MAG PERM 100, REV 1	RETEST MAG PERMEABILITY AT FAILED TEST POINTS. MARK NONCOMPLIANT AREAS WITH AN "X" FOR REPAIR. ACCEPTANCE 1.02. IF OK CHECK HERE _____ IF REJECTED CHECK HERE _____ RETURN TO STEP 450	↓	
460	PHOTOGRAPH	TAKE DIGITAL PICTURES.		
470	AUDIT REVIEW	PROCESS DOCUMENT TO PROGRAM MANAGER FOR COMPLIANCE AUDIT.		
480	DOC. REVIEW	REVIEW DOCUMENTS AS REQUIRED IN CAF CHECKLIST, ALL DOCUMENTS NOTED TO BE ACCESSIBLE FOR AUDITING. (SHIPPER, C OF C, M.T.R., M.T.S., INSPECTION REPORT, X-RAY READER SHEETS AND HEAT TREAT CHARTS)		
NOTICE	RELEASE FROM EIO	PROVIDE DOCUMENTS TO EIO. SENT ON <u>6/25/05</u> BY <u>Chl</u> .	Q ENG OR QA MGR	
490	PACK AND SHIP	PACKAGE AND SHIP TO MAJOR TOOL.		
1000	REVISION HISTORY	ORIGINAL 12-14-04.	CARUUD	



**EIO**  
**Energy Industries of Ohio**  
**SUPPLIER QUALITY RELEASE**

C-2 Doc Package Document # 36
----------------------------------

		Date: 6-27-05
--	--	---------------

I. General Information:		
Project Name:	Modular Coil Winding Form C2	
PO No:	NCSX-SOW-141-02-01	Rev.:
Supplier:	MetalTek	
Procurement Agent:	EIO	
Shipment:	<input checked="" type="checkbox"/> Partial <input type="checkbox"/> Final	

II. Material Description
Casting C2 Coil

III. Release Checklist	
Plan Requirements Complete?	<input checked="" type="checkbox"/> Yes <input type="checkbox"/> No <input type="checkbox"/> N/A (If identified "No" provide explanation in comments section below)
Variances?	<input checked="" type="checkbox"/> Yes <input type="checkbox"/> No <input type="checkbox"/> N/A (If identified "No" provide explanation in comments section below)
Princeton Notified of Shipment?	<input checked="" type="checkbox"/> Yes <input type="checkbox"/> No <input type="checkbox"/> N/A (If identified "No" provide explanation in comments section below)
DCMA Notified of Shipment?	<input checked="" type="checkbox"/> Yes <input type="checkbox"/> No <input type="checkbox"/> N/A (If identified "No" provide explanation in comments section below)
<input checked="" type="checkbox"/> Conditional <input checked="" type="checkbox"/> Unconditional	Explain conditional releases in comments section.

IV. Comments
Variances – See attached package for CA's and deviations Dimensional report evaluated, adequate machine stock exists

By signing below you acknowledge that the casting has met all applicable standards and contractual requirements

V. Supplier Quality Representative Sign Off		
Charles Ruud		6-27-05
Supplier Quality Representative (SQR) Print/Type Name	Supplier Quality Representative (SQR) Signature	Date

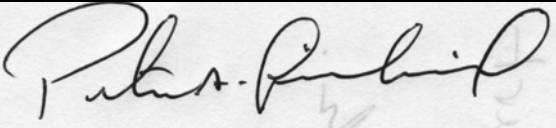
VI. Supplier Approval For Shipment		
Procurement Agent Notified of Shipment	Date: 6-27-05	
Required Vendor Data Ready for Shipment	Date: 6-27-05	
Peter A Djordjevich		6-27-05
X		

**EIO**  
**Energy Industries of Ohio**  
**SUPPLIER QUALITY RELEASE**

<b>C-2 Doc Package</b> <b>Document # 36</b>
--

		Date: 6-27-05
--	--	---------------

I. General Information:		
Project Name:	Modular Coil Winding Form C2	
PO No:	NCSX-SOW-141-02-01	Rev.:
Supplier:	MetalTek	
Procurement Agent:	EIO	
Shipment:	<input checked="" type="checkbox"/> Partial <input type="checkbox"/> Final	
Supplier's Representative Print/Type Name	Supplier's Signature	Date

1. Enter:  
Project Name  
PO Number  
Supplier  
Procurement Agent
2. Enter a brief description of items being released, including applicable drawing number(s), dash or item number(s), drawing revision letter, specification(s), and serial number(s).
3. Self-Explanatory
4. Record any unusual circumstance, such as a conditional release.
5. The Supplier's representative shall sign and date.
7. Signature and date of the Supplier's authorized representative indicating shipping date.
8. In case of partial release, the supplier shall maintain copies of each sequential "Supplier Quality Release" and establish complete accountability of material release on final shipment.
9. Supplier shall include a copy of the completed form with each shipment.