

Place holder

Left in for EIO cover page

(not yet generated)

Place holder

Left in for EIO cover page

(not yet generated)

Energy Industries of Ohio

Contract # S005242-F

Modular Coil Winding Forms

C-5 Documentation Package

**Part 1 – Metal Tek International
Casting Data Package**

3/17/2006

C-5 Documentation Package

List of Documents 3-17-06

Doc #	Description	# Pages
1	MTR for 3 ladles + weighted av. Of chemistry – Original – superseded by MTR from WC & new MTR from MTK (Doc # 2 & 3)	
2	MTR from Wisconsin Centrifugal for 3 ladles + weighted av. of chem..	
3	MTR for 3 ladles + weighted av. Of chem. after preventive maintenance	
4	MTR for C-5 Shim dated 9/24/05	
5	Lincoln weld metal product conformance spec Lot 3018926/78309	
6	St Louis Test Lab dated 8/9/05 mech test results at RT & Charpy V notch @ 293°k for Lincoln lot 3018926/78308 – NOTE page 3 of 3 NA C-5	
7	Westmoreland mech test & CVN @ -320°F – 9/13/05 Lot 3018926/78309	
8	Lincoln weld metal product conformance spec Lot 3018513/78308	
9	St Louis Test Lab dated 8/16/05 mech test results at RT & Charpy V notch @ 293°k for Lincoln lot 3018513/78308	
10	Westmoreland mech test @ -320°F dated 10/18/05 Lot 3018513/78308	
11	St Louis Test Lab -10/5/05 CVN @ -320°F Lincoln Lot # 3018513/78308	
12	Westmoreland Tensile test report @ -320°F dated 10-18-05	
13	Westmoreland Tensile test report @ -320°F dated 10-21-05 - retest	
14	St Louis Test Lab dated 8-18-05 – incl. tensile test results @ room temp & Charpy V Notch (CVN) at 77°K & 293°K	
15	Weld map	
16	Radiographic Standard Shooting Sketch	
17	Radiographic Standard Shooting Sketch – C-shims	
18	MQS Radiographic Inspection Report dated 8/31/05	
19	MQS Radiographic Inspection Report dated 10/13/05	
20	MTK Radiographic Interpretation Report dated 11/07/05	
21	MTK Radiographic Interpretation Report C-5 shim dated 11/08/05	
22	C-5 Coil heat treat chart dated 8/13/05	
23	C-5 Coil stress relief dated 11-14-05	
24	C-5 Shim heat treat chart dated 6-02-05	
25	MTK signed MTS C-5 Coil	
26	MTK signed MTS C-5 Coil shim	
27	CA 1308 – shim chemistry out of spec	
28	CA 1323 – revised & inserted 3/16/06	
29	CA 1379 Failed weld test on Lincoln weld metal # 3018926/78309	
30	CA 1454 for 31% elongation on C-5	
31	Final inspection report C-5 Coil dated 11/04/05	
32	C of C for C-5 Coil dated 11/04/05	
33	Final Inspection report C-5 shim dated 10/28/05	
34	C of C for C–5 shim dated 10/28/05	
35	EIO shipping release for C-5 dated 11/23/05	
3/17/06		



Carondelet Division

8600 Commercial Blvd. - Pevely, MO 63070 USA
Phone: 636-479-4499 - Fax: 636-479-3399

Material Test Report

ENERGY INDUSTRIES OF OHIO

Purchase Order Number PPPL-FP-LTS-2
Pattern Number MCWF-C5 Coil
CAF Metal Designation CF8MNMnMod
Material Spec CF8MNMnMOD
Ladle#1 Heat 30441
Original Chemistry

Cert Number 172810-1
Pour Date 8/8/2005

Element	Min	Actual	Max
C	0.04	0.05	0.07
MN	2.3	2.6	2.8
SI	0.0	0.3	0.7
CR	18.0	18.2	18.5
NI	13.0	13.3	13.5
MO	2.1	2.3	2.5
P	0.0	0.023	0.035
S	0.0	0.011	0.025
N	0.24	0.26	0.28

Respectfully Submitted,
Charles A. Ruud
Quality Assurance Manager



2

Carondelet Division

8600 Commercial Blvd. - Pevely, MO 63070 USA
Phone: 636-479-4499 - Fax: 636-479-3399

Material Test Report

ENERGY INDUSTRIES OF OHIO

Purchase Order Number PPPL-FP-LTS-2
Pattern Number MCWF-C5 Coil
CAF Metal Designation CF8MNMnMod
Material Spec CF8MNMnMOD
Ladle#2 Heat 30442
Original Chemistry

Cert Number 172810-1
Pour Date 8/8/2005

Element	Min	Actual	Max
C	0.04	0.05	0.07
MN	2.3	2.4	2.8
SI	0.0	0.4	0.7
CR	18.0	18.2	18.5
NI	13.0	13.3	13.5
MO	2.1	2.3	2.5
P	0.0	0.033	0.035
S	0.0	0.013	0.025
N	0.24	0.24	0.28

Respectfully Submitted,
Charles A. Ruud
Quality Assurance Manager



3

Carondelet Division

8600 Commercial Blvd. - Pevely, MO 63070 USA
Phone: 636-479-4499 - Fax: 636-479-3399

Material Test Report

ENERGY INDUSTRIES OF OHIO

Purchase Order Number PPPL-FP-LTS-2
Pattern Number MCWF-C5 Coil
CAF Metal Designation CF8MNMnMod
Material Spec CF8MNMnMOD
Ladle#3 Heat 30445
Original Chemistry

Cert Number 172810-1
Pour Date 8/8/2005

Element	Min	Actual	Max
C	0.04	0.05	0.07
MN	2.3	2.4	2.8
SI	0.0	0.3	0.7
CR	18.0	18.3	18.5
NI	13.0	13.2	13.5
MO	2.1	2.4	2.5
P	0.0	0.03	0.035
S	0.0	0.01	0.025
N	0.24	0.25	0.28

Respectfully Submitted,
Charles A. Ruud
Quality Assurance Manager



4

Carondelet Division

8600 Commercial Blvd. - Pevely, MO 63070 USA
Phone: 636-479-4499 - Fax: 636-479-3399

Material Test Report

ENERGY INDUSTRIES OF OHIO

Purchase Order Number PPPL-FP-LTS-2

Cert Number 172810-1

Pattern Number MCWF-C5

Pour Date 8/8/2005

CAF Metal Designation CF8MNMnMod

Material Spec CF8MNMnMOD

Weighted average of 3 heats - 30441(39%),30442(21%),30445(40%) Total Weight 31732 lbs.

Original Chemistry

Element	Min	Actual	Max
C	0.04	0.05	0.07
MN	2.3	2.5	2.8
SI	0.0	0.3	0.7
CR	18.0	18.2	18.5
NI	13.0	13.3	13.5
MO	2.1	2.3	2.5
P	0.0	0.028	0.035
S	0.0	0.011	0.025
N	0.24	0.25	0.28

A handwritten signature in black ink, appearing to read "CARU", is positioned above the typed name of the Quality Assurance Manager.

Respectfully Submitted,
Charles A. Ruud
Quality Assurance Manager



1A

Carondelet Division

8600 Commercial Blvd. - Pevely, MO 63070 USA
Phone: 636-479-4499 - Fax: 636-479-3399

Material Test Report

ENERGY INDUSTRIES OF OHIO

Purchase Order Number PPPL-FP-LTS-2

Pattern Number MCWF-C5 Coil

CAF Metal Designation CF8MNMnMod

Material Spec CF8MNMnMOD

Ladle#1 Heat 30441

Analysis performed by Wisconsin Centrifugal

Cert Number 172810-1

Pour Date 8/8/2005

Element	Min	Actual	Max
C	0.04	0.02	0.07
MN*	2.3	2.2	2.8
SI	0.0	0.3	0.7
CR	18.0	18.2	18.5
NI	13.0	13.5	13.5
MO	2.1	2.4	2.5
P	0.0	0.025	0.035
S	0.0	0.010	0.025
N	0.24	0.25	0.28

* See Corrective Action Number 1323.

Respectfully Submitted,
Charles A. Ruud
Quality Assurance Manager



2 A

Carondelet Division

8600 Commercial Blvd. - Pevely, MO 63070 USA
Phone: 636-479-4499 - Fax: 636-479-3399

Material Test Report

ENERGY INDUSTRIES OF OHIO

Purchase Order Number PPPL-FP-LTS-2

Pattern Number MCWF-C5 Coil

CAF Metal Designation CF8MNMnMod

Material Spec CF8MNMnMOD

Ladle#2 Heat 30442

Analysis performed by Wisconsin Centrifugal

Cert Number 172810-1

Pour Date 8/8/2005

Element	Min	Actual	Max
C	0.04	0.05	0.07
MN*	2.3	1.8	2.8
SI	0.0	0.4	0.7
CR	18.0	18.2	18.5
NI	13.0	13.4	13.5
MO	2.1	2.5	2.5
P	0.0	0.034	0.035
S	0.0	0.018	0.025
N	0.24	0.23	0.28

* See Corrective Action Number 1323.

Respectfully Submitted,
Charles A. Ruud
Quality Assurance Manager



3A

Carondelet Division

8600 Commercial Blvd. - Pevely, MO 63070 USA
Phone: 636-479-4499 - Fax: 636-479-3399

Material Test Report

ENERGY INDUSTRIES OF OHIO

Purchase Order Number PPPL-FP-LTS-2

Cert Number 172810-1

Pattern Number MCWF-C5 Coil

Pour Date 8/8/2005

CAF Metal Designation CF8MNMnMod

Material Spec CF8MNMnMOD

Ladle#3 Heat 30445

Analysis performed by Wisconsin Centrifugal

Element	Min	Actual	Max
C	0.04	0.04	0.07
MN*	2.3	2.0	2.8
SI	0.0	0.3	0.7
CR	18.0	18.3	18.5
NI	13.0	13.3	13.5
MO	2.1	2.4	2.5
P	0.0	0.031	0.035
S	0.0	0.018	0.025
N	0.24	0.24	0.28

* See Corrective Action Number 1323.

Respectfully Submitted,
Charles A. Ruud
Quality Assurance Manager



4.17

Carondelet Division

8600 Commercial Blvd. - Pevely, MO 63070 USA
Phone: 636-479-4499 - Fax: 636-479-3399

Material Test Report

ENERGY INDUSTRIES OF OHIO

Purchase Order Number PPPL-FP-LTS-2

Cert Number 172810-1

Pattern Number MCWF-C5

Pour Date 8/8/2005

CAF Metal Designation CF8MNMnMod

Material Spec CF8MNMnMOD

Weighted average of 3 heats - 30441(39%),30442(21%),30445(40%) Total Weight 31732 lbs.

Analysis performed by Wisconsin Centrifugal

Element	Min	Actual	Max
C	0.04	0.04	0.07
MN*	2.3	2.0	2.8
SI	0.0	0.3	0.7
CR	18.0	18.2	18.5
NI	13.0	13.4	13.5
MO	2.1	2.4	2.5
P	0.0	0.030	0.035
S	0.0	0.015	0.025
N	0.24	0.24	0.28

* See Corrective Action Number 1323.

Respectfully Submitted,
Charles A. Ruud
Quality Assurance Manager



1B

Carondelet Division

8600 Commercial Blvd. - Pevely, MO 63070 USA
Phone: 636-479-4499 - Fax: 636-479-3399

Material Test Report

ENERGY INDUSTRIES OF OHIO

Purchase Order Number PPPL-FP-LTS-2

Pattern Number MCWF-C5 Coil

CAF Metal Designation CF8MNMnMod

Material Spec CF8MNMnMOD

Ladle#1 Heat 30441

Retest after preventive maintenance

Cert Number 172810-1

Pour Date 8/8/2005

Element	Min	Actual	Max
MN	2.3	2.3	2.8
SI	0.0	0.3	0.7
CR	18.0	18.3	18.5
NI	13.0	13.4	13.5
MO	2.1	2.4	2.5
P	0.0	0.029	0.035
S	0.0	0.012	0.025

C & N not analyzed by spectrometer on retest.

Respectfully Submitted,
Charles A. Ruud
Quality Assurance Manager

Superior Quality Engineered Metal Products

www.MetalTekInt.Com



2 B

Carondelet Division

8600 Commercial Blvd. - Pevely, MO 63070 USA
Phone: 636-479-4499 - Fax: 636-479-3399

Material Test Report

ENERGY INDUSTRIES OF OHIO

Purchase Order Number PPPL-FP-LTS-2

Pattern Number MCWF-C5 Coil

CAF Metal Designation CF8MNMnMod

Material Spec CF8MNMnMOD

Ladle#2 Heat 30442

Retest after preventive maintenance

Cert Number 172810-1

Pour Date 8/8/2005

Element	Min	Actual	Max
MN*	2.3	1.8	2.8
SI	0.0	0.4	0.7
CR	18.0	18.3	18.5
NI	13.0	13.3	13.5
MO	2.1	2.5	2.5
P	0.0	0.034	0.035
S	0.0	0.012	0.025

- See Corrective Action Number 1323.
C & N not analyzed by spectrometer on retest.

Respectfully Submitted,
Charles A. Ruud
Quality Assurance Manager

3B



Carondelet Division

8600 Commercial Blvd. - Pevely, MO 63070 USA
Phone: 636-479-4499 - Fax: 636-479-3399

Material Test Report

ENERGY INDUSTRIES OF OHIO

Purchase Order Number PPPL-FP-LTS-2

Pattern Number MCWF-C5 Coil

CAF Metal Designation CF8MNMnMod

Material Spec CF8MNMnMOD

Ladle#3 Heat 30445

Retest after preventive maintenance

Cert Number 172810-1

Pour Date 8/8/2005

Element	Min	Actual	Max
MN*	2.3	2.0	2.8
SI	0.0	0.3	0.7
CR	18.0	18.4	18.5
NI	13.0	13.3	13.5
MO	2.1	2.4	2.5
P	0.0	0.033	0.035
S	0.0	0.012	0.025

* See Corrective Action Number 1323.

C & N not analyzed by spectrometer on retest.

Respectfully Submitted,
Charles A. Ruud
Quality Assurance Manager

Superior Quality Engineered Metal Products

www.MetalTekInt.Com



HB

Carondelet Division

8600 Commercial Blvd. - Pevely, MO 63070 USA
Phone: 636-479-4499 - Fax: 636-479-3399

Material Test Report

ENERGY INDUSTRIES OF OHIO

Purchase Order Number PPPL-FP-LTS-2

Cert Number 172810-1

Pattern Number MCWF-C5

Pour Date 8/8/2005

CAF Metal Designation CF8MNMnMod

Material Spec CF8MNMnMOD

Weighted average of 3 heats - 30441(39%),30442(21%),30445(40%) Total Weight 31732 lbs.

Retest after preventive maintenance

Element	Min	Actual	Max
MN*	2.3	2.1	2.8
SI	0.0	0.3	0.7
CR	18.0	18.3	18.5
NI	13.0	13.3	13.5
MO	2.1	2.4	2.5
P	0.0	0.032	0.035
S	0.0	0.012	0.025

* See Corrective Action Number 1323.

C & N not analyzed by spectrometer on retest.

Respectfully Submitted,
Charles A. Ruud
Quality Assurance Manager



Carondelet Division

8600 Commercial Blvd. - Pevely, MO 63070 USA
Phone: 636-479-4499 - Fax: 636-479-3399

Material Test Report

ENERGY INDUSTRIES OF OHIO

Purchase Order Number PPPL-FP-LTS-2 Heat Number 29198 Pour Date 4/28/2005
Pattern Number SE-141-073 COIL C SHIM (-3 thru -6 Parts) Cert Number S73220-2 and
SE-141-033 COIL A SHIM (-1 thru -6 Parts) Cert Number S76220-1
CAF Metal Designation CF8MNMnMod
Material Spec CF8MNMN MOD

Revised 9/24/05

Element	Min	Actual	Max
C	0.040	0.070	0.070
CR	18.000	18.100	18.500
MN	2.300	2.970	2.800
MO	2.100	2.450	2.500
N	0.240	0.255	0.280
NI	13.000	13.120	13.500
P*	0.000	0.013	0.035
S*	0.000	0.010	0.025
SI	0.000	0.700	0.700

MN & SI previously reported on CA 1308 and were accepted.

*P & S taken from test from heat parts were poured from and analyzed by wet chemistry, ASTM E1019-03 for sulfur and Gravimetric for phosphorous.

This report covers the eleven castings poured from heat 29198. Only parts listed above however will be shipped for this order. Each casting has a unique number stamped in the part adjacent to the pattern number to differentiate the part and subsequent reporting that will be traced to the casting.

Specification limits have been updated to latest specification.

Respectfully Submitted,
Charles A. Ruud
Quality Assurance Manager

Superior Quality Engineered Metal Products

www.MetalTekInt.Com

.045

ER316 MNN F
**LINCOLN®
ELECTRIC**

PRODUCT CONFORMANCE REPORT

Product	LNM 4455	Size(s) mm	1,2
Class.	EN 12072-99: G 20 16 3 Mn L	Lot/Batch	3018926/78309
		Item No.	692129
Customer	CK SUPPLY Contact Ernie Simpson Eureka (MISSOURI) 63025 UNITED STATES	Quantity	450,0 KG
		Customer ref.	P.O.: SL 057549
		LSW Order No.	SD424496

Chemical analysis (%)										EN10204 3.1B
C	Si	Mn	P	S	Cr	Ni	Mo	Cu	N	
0,02	0,4	7,3	0,019	0,001	20,1	16,3	2,9	0,1	0,200	

Mechanical tests, all weld metal	EN10204
----------------------------------	---------

Additional information Other tests	EN10204
---------------------------------------	---------

Remarks

The product identified above has been manufactured, tested and supplied in compliance with a Quality Assurance Programme that fulfils the requirements of EN 29000/ ISO 9000/BS 5750 or similar standard.
We herewith certify that the product complies with the above-mentioned standards.
Certified ISO 9001:2000.

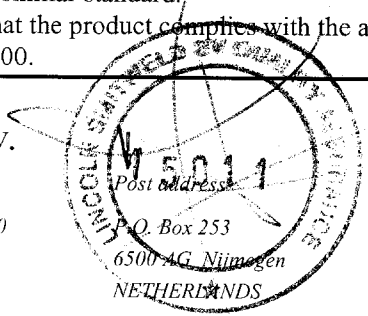

Company	Issued by	Function	Date	Cert.No.
Lincoln Smitweld B.V.	P. van Etteger	QS Manager	10/02/2005	3018926/7830
Registered Office	Telephone:	Fax:		
Nieuwe Dukenburgseweg 20	31 24 3522911	31 24 3522200		
6534 18 NIJMEGEN				



10

2810 Clark Avenue • St. Louis, MO 63103-2574 • (314) 531-8080 • FAX (314) 531-8085
 Chemical, Metallurgical, Mechanical, Nondestructive, Environmental Testing, Analyses and Field Service.

METALTEK INTERNATIONAL
 8600 Commercial Blvd.
 Pevely, MO 63070

August 8, 2005
 Lab No. 05P-2334
 P.O. No. 21324
 Page 1 of 3

Attention: **CHUCK RUUD**

REPORT OF MECHANICAL TESTS

SAMPLE ID: 1) STOCK# LNM 4455, LINCOLN LOT 3018926/78309
 2) STOCK# LNM 4455, LINCOLN LOT 3017006/72262
 3) STOCK# LNM 4455, LINCOLN LOT 3012668/82743
 4) STOCK# B316NF METRODE, W021735

Sample ID	Original Area Sq. Inches	Reduced Area Sq. Inches	Reduction in Area %	Modules of Elasticity	Yield Strength PSI	Tensile Strength PSI	Elongation (2.0" Gage Length)	
							in.	%
1	0.1385	0.0897	54.3	24.5 Msi	56900	93900	0.84	42.0
2	0.1886	0.0935	50.4	24.9 Msi	54900	92100	0.85	42.5
3	0.1909	0.0951	50.2	22.6 Msi	57400	93700	0.83	41.5
4	0.1901	0.0962	49.4	23.0 Msi	54800	88200	0.75	37.5

Round, reduced section all weld tensiles

Yield taken at .2% offset

Tested in accordance with ASTM A 370-03a

Identification of tested specimens provided by the client.

Karl Schmitz, Director
 Materials Testing

KS/tiv



Certificate No. 0397-01
 Certificate No. 0397-02

19

AN OFFICIAL COPY OF TEST REPORT WILL BE PROVIDED BY THIS LABORATORY ON REQUEST.
 NOT OFFICIAL WITHOUT THE RAISED SEAL OF ST. LOUIS TESTING LABORATORIES, INC.
 SEE REVERSE FOR CONDITIONS.





10

2810 Clark Avenue • St. Louis, MO 63103-2574 • (314) 531-8080 • FAX (314) 531-8085
 Chemical, Metallurgical, Mechanical, Nondestructive, Environmental Testing, Analyses and Field Service.

METALTEK INTERNATIONAL
 8600 Commercial Blvd.
 Pevely, MO 63070

August 8, 2005
 Lab No. 05P-2334
 P.O. No. 21324
 Page 2 of 3

Attention: Chuck Ruud

REPORT OF CHARPY IMPACT TEST

MATERIAL (SAMPLE ID): STOCK# LNM 4455, LINCOLN LOT 3018926/78309
 STOCK# LNM 4455, LINCOLN LOT 3017006/72262

SPECIFICATION: ASTM A 370-03a
SPECIMEN TYPE: "A" Vee Notch
SPECIMEN SIZE: 10 mm x 10 mm (All Weld)
TEMPERATURE OF TEST: 293°K

REQUIREMENTS:

ALL WELD	FOOT LBS.	LATERAL EXPANSION	% SHEAR
78309-7	97	0.074	50
78309-8	96	0.076	50
78309-9	108	0.075	50
Average	100	0.075	50
ALL WELD	FOOT LBS.	LATERAL EXPANSION	% SHEAR
72262-7	126	0.098	50
72262-8	102	0.080	50
72262-9	123	0.087	50
Average	117	0.088	50

Identification of tested specimen provided by client.

KS/tv

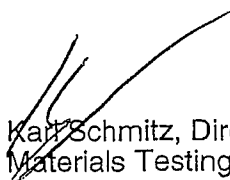
 Karl Schmitz, Director
 Materials Testing



Certificate No. 0397-01
 Certificate No. 0397-02

AN OFFICIAL COPY OF TEST REPORT WILL BE PROVIDED BY THIS LABORATORY ON REQUEST.
 NOT OFFICIAL WITHOUT THE RAISED SEAL OF ST. LOUIS TESTING LABORATORIES, INC.
 SEE REVERSE FOR CONDITIONS.

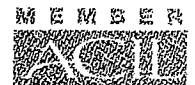

2810 Clark Avenue • St. Louis, MO 63103-2574 • (314) 531-8080 • FAX (314) 531-8085
 Chemical, Metallurgical, Mechanical, Nondestructive, Environmental Testing, Analyses and Field Service.

METALTEK INTERNATIONAL
 8600 Commercial Blvd.
 Pevely, MO. 63070

August 8, 2005
 Lab No. 05P-2334
 P.O. No. 21324
 Page 3 of 3

Attention: Chuck Ruud

REPORT OF CHARPY IMPACT TEST

MATERIAL (SAMPLE ID): STOCK# LNM 4455, LINCOLN LOT 3012668/82743
 STOCK# B316NF METRODE, W021735

SPECIFICATION: ASTM A 370-03a

SPECIMEN TYPE: "A" Vee Notch

SPECIMEN SIZE: 10 mm x 10 mm (All Weld)

TEMPERATURE OF TEST: 293°K

REQUIREMENTS:

ALL WELD	FOOT LBS.	LATERAL EXPANSION	% SHEAR
82743-7	100	0.082	50
82743-8	99	0.076	50
82743-9	94	0.072	50
Average	98	0.077	50
ALL WELD	FOOT LBS.	LATERAL EXPANSION	% SHEAR
W021735-7	102	0.101	50
W021735-8	88	0.073	50
W021735-9	88	0.080	50
Average	93	0.085	50

Identification of tested specimen provided by client.

 Karl Schmitz, Director
 Materials Testing

KS/tlv



Certificate No. 0397-01
 Certificate No. 0397-02

21

AN OFFICIAL COPY OF TEST REPORT WILL BE PROVIDED BY THIS LABORATORY ON REQUEST.
 NOT OFFICIAL WITHOUT THE RAISED SEAL OF ST. LOUIS TESTING LABORATORIES, INC.
 SEE REVERSE FOR CONDITIONS.

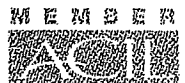

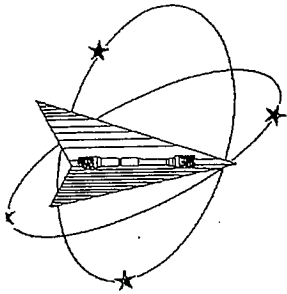

Westmoreland Mechanical Testing & Research, Inc.

P.O. Box 388

Westmoreland Drive

Youngstown, Pa. 15696-0388 U.S.A.

Telephone: 724-537-3131 Fax: 724-537-3151

Website: www.wmtr.com

WMT&R is a technical leader in the material testing industry.



621-01 & 621-02



September 13, 2005

CERTIFICATION

MetalTek International
The Carondelet Division
8600 Commercial Blvd.
I-55 Industrial Park
Pevely, MO 63070-1528

Attention: Jim Galaske

Subject: All processes, performed upon the material as received, were conducted at WMT&R, Inc. in accordance with the WMT&R Quality Assurance Manual, Rev. 9, dated 4/1/2000.
The following tests were performed on this order: IMPACT and TENSILE

WMT&R Report No. 5-34328
P.O. No. 19386 Rel No.18
Requisition No. 4934

TENSILE RESULTS: ASTM E21-03a

Requirements: UTS ksi (Min 95\Max ---) 0.2% YS ksi (Min 72\Max ---) 4D Elong. % (Min 32\Max ---) Modulus Msi (Min 21\Max ---)

SOAK TIME: 5 Minutes

SPEED OF TESTING: 0.0030 in./in./min., 0.0500 in./min./in.

MATERIAL: 316 S/S

DISPOSITION: Acceptable

Reference	Lot No. Batch No. Specimen ID	TestLog Number	Temp. °F	UTS ksi	0.2% YS ksi	Elong %	RA %	Modulus Msi	Ult. Load lbf	0.2% YLD. lbf
Lincoln LNM4455	3018926 78309 Tensile	C43938	-320	182.1	128.2	34	24	27.0	17560	12360

AIUR: A=ACCEPTABLE, U=UNACCEPTABLE, R=REPORT

DISPOSITION: Acceptable

Reference	Lot No. Batch No. Specimen ID	TestLog Number	Orig. Dia. (in.)	Final Dia. (in.)	4D Orig GL (in.)	4D Final GL (in.)	Orig. Area (sq. in.)	Machine Number	AIUR
Lincoln LNM4455	3018926 78309 Tensile	C43938	0.3504	0.3048	1.40	1.87	0.09643131	M9	A

AIUR: A=ACCEPTABLE, U=UNACCEPTABLE, R=REPORT

Requirements supplied by MetalTek International.

Rby E. Starr
Technical Services Manager

9-13-05
September 13, 2005

KNOWINGLY OR WILLFULLY FALSIFYING OR CONCEALING A MATERIAL FACT ON THIS FORM OR MAKING FALSE, FICTITIOUS OR FRAUDULENT STATEMENTS OR REPRESENTATIONS HEREIN COULD CONSTITUTE A FELONY PUNISHABLE UNDER FEDERAL STATUTES. THIS CERTIFICATE OF REPORT SHALL NOT BE REPRODUCED EXCEPT IN FULL, WITHOUT THE WRITTEN APPROVAL OF WMTR, INC.

Testing Specialists for Aerospace, Automotive, and Material Testing Fields
Locations in Youngstown, PA U.S.A. ~ Tel. (724) 537-3131 and
Banbury U.K. ~ Tel. +44 (0) 1295 261211

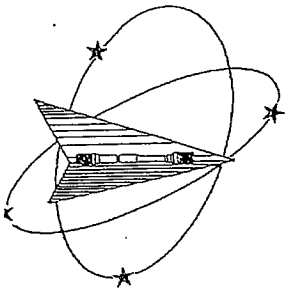

Westmoreland Mechanical Testing & Research, Inc.

P.O. Box 388

Westmoreland Drive

Youngstown, Pa. 15696-0388 U.S.A.

Telephone: 724-537-3131 Fax: 724-537-3151

Website: www.wmtr.com

WMT&R is a technical leader in the material testing industry.



621-01 & 621-02



September 13, 2005

CERTIFICATION

MetalTek International
The Carondelet Division
8600 Commercial Blvd.
I-55 Industrial Park
Pevely, MO 63070-1528

WMT&R Report No. 5-34328

P.O. No. 19386 Rel No.18

Requisition No. 4934

Attention: Jim Galaske

Subject: All processes, performed upon the material as received, were conducted at WMT&R, Inc. in accordance with the WMT&R Quality Assurance Manual, Rev. 9, dated 4/1/2000.

The following tests were performed on this order: IMPACT and TENSILE

IMPACT RESULTS: ASTM E23-02

REQUIREMENTS: Energy (Min 35\Max →)

MATERIAL: Lincoln LNM4455

SAMPLE TYPE: Charpy V-Notch

DISPOSITION: Acceptable

Reference	Lot No. Batch No. Specimen ID	TestLog Number	Sample Size	Temp. °F	Energy ft-lbs	Mils Lat Exp	% Shear Fracture	AIUR
Lincoln LNM4455	3018926 78309 Cvn-1	C43939	Standard	-320	56	18	40	Acceptable
Lincoln LNM4455	3018926 78309 Cvn-2	C43940	Standard	-320	52	18	40	Acceptable
Lincoln LNM4455	3018926 78309 Cvn-3	C43941	Standard	-320	53	12	40	Acceptable

Requirements supplied by MetalTek International.



Roy E. Star, Matt Wojcik
Technical Services Manager / Tensile Supervisor

9-13-05

September 13, 2005

KNOWINGLY OR WILLFULLY FALSIFYING OR CONCEALING A MATERIAL FACT ON THIS FORM OR MAKING FALSE, FICTITIOUS OR FRAUDULENT STATEMENTS OR REPRESENTATIONS HEREIN COULD CONSTITUTE A FELONY PUNISHABLE UNDER FEDERAL STATUTES. THIS CERTIFICATE OF REPORT SHALL NOT BE REPRODUCED EXCEPT IN FULL, WITHOUT THE WRITTEN APPROVAL OF WMT&R, INC.

Testing Specialists for Aerospace, Automotive, and Material Testing Fields
Locations in Youngstown, PA U.S.A. ~ Tel. (724) 537-3131 and
Banbury U.K. ~ Tel. +44 (0) 1295 261211

9A

PRODUCT CONFORMANCE REPORT



Product	ENM 4455	Size(s) mm	1,2
Class	EN 12072-99: G 20 16 3 Mn L	Lot/Batch	3018513/78308
		Item No.	692129
Customer	EUROWELD MOORESVILLE N.C. 28117 UNITED STATES	Quantity	105,0 KG
		Customer ref.	P.O. 05 - 46
		LSW Order No.	SD427896

Chemical analysis (%) EN10204 2.2

C	Si	Mn	P	S	Cr	Ni	Mo	Cu	N
0,01	0,5	7,3	0,015	0,001	20,3	15,4	2,9	0,1	0,19

Mechanical tests, all weld metal EN10204 2.2

Tensile testing					Impact testing		
Cond.	Temp.	Rp0.2	Rm	A5	Cond.	Temp.1	Av1
	°C	N/mm2	N/mm2	%		°C	J
AW	RT	407	623	41	AW	-196	67

Additional information EN10204 2.2

Other tests

Remarks
Impact testing (individual values): 70J - 65J - 67J.

The product identified above has been manufactured, tested and supplied in compliance with a Quality Assurance Programme that fulfils the requirements of EN 29000/ ISO 9000/BS 5750 or similar standard.
We herewith certify that the product complies with the above mentioned standards.
Certified ISO 9001:2000.

Company	Issued by	Function	Date	Cert.No.
Lincoln Smitweld B.V.	P. Nagels	QA Administrator	22/03/2005	3018513/7830
Registered Office	Telephone	Fax:		
Nijmegen Dukenburgseweg 20	31 24 3522911	31 24 3522200		
6594 AD NIJMEGEN	Post address			
	P.O. Box 253			
	6500 AG Nijmegen			

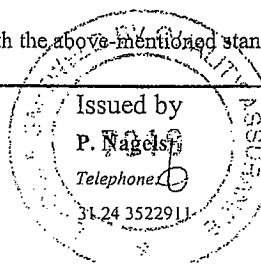

2810 Clark Avenue • St. Louis, MO 63103-2574 • (314) 531-8080 • FAX (314) 531-8085
 Chemical, Metallurgical, Mechanical, Nondestructive, Environmental Testing, Analyses and Field Service.

METALTEK INTERNATIONAL
 8600 Commercial Blvd.
 Pevely, MO 63070

August 16, 2005
 Lab No. 05P-2532
 P.O. No. 21324
 Page 1 of 2

Attention: Chuck Ruud

REPORT OF CHARPY IMPACT TEST

MATERIAL (SAMPLE ID): LNM 4455, LINCOLN LOT 3018513/78308
SPECIFICATION: ASTM A 370-03a
SPECIMEN TYPE: "A" Vee Notch
SPECIMEN SIZE: 10 mm x 10 mm
TEMPERATURE OF TEST: 293°K

BASE METAL	FOOT LBS.	LATERAL EXPANSION	% SHEAR
LNM4455-7	104	0.085	100
LNM4455-8	106	0.093	100
LNM4455-9	99	0.084	100
Average	103	0.087	100

Identification of tested specimen provided by client.

KS/tlv

 Karl Schmitz, Director
 Materials Testing



Certificate No. 0397-01
 Certificate No. 0397-02

AN OFFICIAL COPY OF TEST REPORT WILL BE PROVIDED BY THIS LABORATORY ON REQUEST.
 NOT OFFICIAL WITHOUT THE RAISED SEAL OF ST. LOUIS TESTING LABORATORIES, INC.
 SEE REVERSE FOR CONDITIONS.



2810 Clark Avenue • St. Louis, MO 63103-2574 • (314) 531-8080 • FAX (314) 531-8085
 Chemical, Metallurgical, Mechanical, Nondestructive, Environmental Testing, Analyses and Field Service.

METALTEK INTERNATIONAL
 8600 Commercial Blvd.
 Pevely, MO 63070

August 16, 2005
 Lab No. 05P-2532
 P.O. No. 21324
 Page 2 of 2

Attention: CHUCK RUUD

REPORT OF MECHANICAL TESTS

SAMPLE ID: LNM 4455, LINCOLN LOT 3018513/78308

Sample ID	Original Area Sq. Inches	Reduced Area Sq. Inches	Reduction in Area %	Yield Strength PSI	Tensile Strength PSI	Elongation (2.0" Gage Length)		Modules of Elasticity
						in.	%	
LNM4455	0.1932	0.0866	55.2	65200	95200	0.76	38.0	23.4

Round, reduced section tensiles

Yield taken at .2% offset

Tested in accordance with ASTM A 370-03a

Identification of tested specimens provided by the client.

 Karl Schmitz, Director
 Materials Testing

KS/tlv



Certificate No. 0397-01
 Certificate No. 0397-02

AN OFFICIAL COPY OF TEST REPORT WILL BE PROVIDED BY THIS LABORATORY ON REQUEST.
 NOT OFFICIAL WITHOUT THE RAISED SEAL OF ST. LOUIS TESTING LABORATORIES, INC.
 SEE REVERSE FOR CONDITIONS.



11A

..#302222 PAGE: 2/2

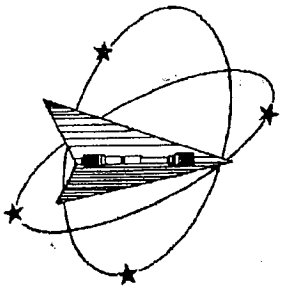

Westmoreland Mechanical Testing & Research, Inc.
 P.O. Box 388
 Westmoreland Drive
 Youngstown, Pa. 15696-0388 U.S.A.
 Telephone: 724-537-3131 Fax: 724-537-3151
 Website: www.wmtr.com
 WMT&R is a technical leader in the material testing industry.



Section 1 of 1

WMT&R Report No. 5-35979
Requisition No. 4972

October 18, 2005

CERTIFICATION

MetalTek International
 The Carondelet Division
 8600 Commercial Blvd.
 I-55 Industrial Park
 Pevely, MO 63070-1528

Attention: Jim Galaske

Subject: All processes, performed upon the material as received, were conducted at WMT&R, Inc. in accordance with the WMT&R Quality Assurance Manual, Rev. 9, dated 4/1/2000.
 The following tests were performed on this order: TENSILE

TENSILE RESULTS: ASTM E21-03a

SOAK TIME: 5 Minutes

SPEED OF TESTING: 0.0030 in./in./min., 0.0500 in./min./in.

MATERIAL: METALTEK CF8MNMNMOD

DISPOSITION: Report

Specimen ID	TestLog Number	Temp. °F	UTS ksi	0.2% YS ksi	Elong %	RA %	Modulus Msi	Ult. Load lbf	0.2% YLD. lbf	Orig. Dia. (in.)	Final Dia. (in.)	4D Orig GL (in.)	4D Final GL (in.)	Orig. Area (sq. in.)	Machine Number	AIUR
3018513/78308	C54936	-320	184.9	123.7	33	33	32.8	18470	12350	0.3566	0.2926	1.40	1.86	0.09987403	M9	R

AIUR: A=ACCEPTABLE, U=UNACCEPTABLE, R=REPORT

FAX NO: 5377001

14:24 OCT 18, 2005

 Roy E. Starnati Wojton
 Technical Services Manager Tensile Supervisor

10-18-05

October 18, 2005

KNOWINGLY OR WILLFULLY FALSIFYING OR CONCEALING A MATERIAL FACT ON THIS FORM OR MAKING FALSE, FICTITIOUS OR FRAUDULENT STATEMENTS OR REPRESENTATIONS HEREIN COULD CONSTITUTE A FELONY PUNISHABLE UNDER FEDERAL STATUTES. THIS CERTIFICATE OR REPORT SHALL NOT BE REPRODUCED EXCEPT IN FULL, WITHOUT THE WRITTEN APPROVAL OF WMT&R, INC.

Testing Specialists for Aerospace, Automotive, and Material Testing Fields
 Locations in Youngstown, PA U.S.A. ~ Tel. (724) 537-3131 and
 Banbury U.K. ~ Tel. +44 (0) 1295 261211

11A



2810 Clark Avenue • St. Louis, MO 63103-2574 • (314) 531-8080 • FAX (314) 531-8085
Chemical, Metallurgical, Mechanical, Nondestructive, Environmental Testing, Analyses and Field Service.

METALTEK INTERNATIONAL
8600 Commercial Blvd.
Pevely, MO 63070

October 5, 2005
Lab No. 05P-3096
P.O. No. 21324
Page 1 of 1

Attention: Chuck Ruud

REPORT OF CHARPY IMPACT TEST

MATERIAL (SAMPLE ID): WELD PLATE- 3018513 / 78308
SPECIFICATION: ASTM A 370-03a
SPECIMEN TYPE: "A" Vee Notch
SPECIMEN SIZE: 10 mm x 10 mm
TEMPERATURE OF TEST: -320°F
REQUIREMENTS: minimum 35 ft / lbs.

BASE METAL	FOOT LBS.	LATERAL EXPANSION	% SHEAR
3018513/78308-1	48	0.033	50
3018513/78308-2	65	0.045	50
3018513/78308-3	48	0.033	50
Average	54	0.037	50

Identification of tested specimen provided by client.

KS/tlv



Karl Schmitz, Director
Materials Testing



Certificate No. 0397-01
Certificate No. 0397-02

AN OFFICIAL COPY OF TEST REPORT WILL BE PROVIDED BY THIS LABORATORY ON REQUEST.
NOT OFFICIAL WITHOUT THE RAISED SEAL OF ST. LOUIS TESTING LABORATORIES, INC.
SEE REVERSE FOR CONDITIONS.

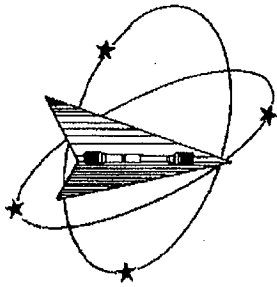



Westmoreland Mechanical Testing & Research, Inc.

P.O. Box 388
Westmoreland Drive
Youngstown, Pa. 15696-0388 U.S.A.
Telephone: 724-537-3131 Fax: 724-537-3151
Website: www.wmtr.com

WMT&R is a technical leader in the material testing industry.



621-01 & 621-02

7A

October 18, 2005

CERTIFICATION

Section 1 of 1

WMT&R Report No. 5-35978
Requisition No. 4972

MetalTek International
The Carondelet Division
8600 Commercial Blvd.
I-55 Industrial Park
Pevely, MO 63070-1528

Corrected Date
November 18, 2005

Test 1

Attention: Jim Galaske

Subject: All processes, performed upon the material as received, were conducted at WMT&R, Inc. in accordance with the WMT&R Quality Assurance Manual, Rev. 9, dated 4/1/2000.
The following tests were performed on this order: TENSILE

TENSILE RESULTS: ASTM E21-05

SOAK TIME: 5 Minutes

SPEED OF TESTING: 0.0030 in./in./min., 0.0500 in./min./in.

MATERIAL: METALTEK CF8MNMNMOD

DISPOSITION: Report

Specimen ID	Test Log Number	Temp. °F	UTS ksi	0.2% YS ksi	Elong %	RA %	Modulus Msi	Ult. Load lbf	0.2% YLD. lbf	Orig. Dia. (in.)	Final Dia. (in.)	4D Orig GL (in.)	4D Final GL (in.)	Orig. Area (sq. in.)	Machine Number	AIUR
C5-Z1	C54933	-320	182.5	112.6	31	28	33.0	18350	11320	0.3578	0.3039	1.40	1.83	0.10054733	M9	R
C5-Z2	C54934	-320	166.1	98.3	52	52	31.8	16740	9903	0.3582	0.2471	1.40	2.13	0.10077227	M9	R
C5-Z3	C54935	-320	163.7	95.5	59	58	28.0	16490	9622	0.3581	0.2316	1.40	2.23	0.10071601	M9	R

AIUR: A=ACCEPTABLE, U=UNACCEPTABLE, R=REPORT

Matt Wojton
Roy E. Starin
Technical Services Manager / Tensile Supervisor

11/18/05
November 18, 2005

KNOWINGLY OR WILLFULLY FALSIFYING OR CONCEALING A MATERIAL FACT ON THIS FORM OR MAKING FALSE, FICTITIOUS OR FRAUDULENT STATEMENTS OR REPRESENTATIONS HEREIN COULD CONSTITUTE A FELONY PUNISHABLE UNDER FEDERAL STATUTES. THIS CERTIFICATE OR REPORT SHALL NOT BE REPRODUCED EXCEPT IN FULL AND WITHOUT THE WRITTEN APPROVAL OF WMT&R, INC.

Testing Specialists for Aerospace, Automotive, and Material Testing Fields
Locations in Youngstown, PA U.S.A. ~ Tel. (724) 537-3131 and
Banbury U.K. ~ Tel. +44 (0) 1295 261211

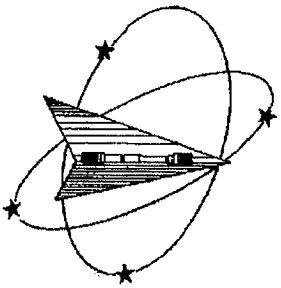

Westmoreland Mechanical Testing & Research, Inc.
 P.O. Box 388
 Westmoreland Drive
 Youngstown, Pa. 15696-0388 U.S.A.
 Telephone: 724-537-3131 Fax: 724-537-3151
 Website: www.wmtr.com
 WMT&R is a technical leader in the material testing industry.

7B



621-01 & 621-02

November 21, 2005

CERTIFICATION

Section 1 of 2

MetalTek International
 The Carondelet Division
 8600 Commercial Blvd.
 I-55 Industrial Park
 Pevely, MO 63070-1528

WMT&R Report No. 5-39106
 P.O. No. 19386
 Requisition No. 4985

Test 2

Attention: Jim Galaske

Subject: All processes, performed upon the material as received, were conducted at WMT&R, Inc. in accordance with the WMT&R Quality Assurance Manual, Rev. 9, dated 4/1/2000.
 The following tests were performed on this order: TENSILE

TENSILE RESULTS: ASTM E21-05

Requirements: UTS ksi (Min 95\Max ---) 0.2% YS ksi (Min 72\Max ---) 4D Elong. % (Min 32\Max ---) Modulus Msi (Min 21\Max ---)

SOAK TIME: 5 Minutes

SPEED OF TESTING: 0.003 in./in./min., 0.05 in./min./in.

MATERIAL: Metaltek CF8MNMnMOD

DISPOSITION: Acceptable

Specimen ID	Test Log Number	Temp. °F	UTS ksi	0.2% YS ksi	Elong %	RA %	Modulus Msi	Ult. Load lbf	0.2% YLD. lbf	Orig. Dia. (in.)	Final Dia. (in.)	4D Orig GL (in.)	4D Final GL (in.)	Orig. Area (sq. in.)	Machine Number	AI\UR
C5-Z2	C67051	-320	172.3	102.5	41	32	28.2	16630	9893	0.3506	0.2885	1.40	1.98	0.09654142	M9	A
C5-Z3	C67052	-320	163.5	95.0	64	67	25.9	15830	9200	0.3511	0.2006	1.40	2.30	0.09681698	M9	A

AI\UR: A=ACCEPTABLE, U=UNACCEPTABLE, R=REPORT

Roy E. Starr\Matt Wojton
 Technical Services Manager\Tensile Supervisor

November 21, 2005

KNOWINGLY OR WILLFULLY FALSIFYING OR CONCEALING A MATERIAL FACT ON THIS FORM OR MAKING FALSE, FICTITIOUS OR FRAUDULENT STATEMENTS OR REPRESENTATIONS HEREIN COULD CONSTITUTE A FELONY PUNISHABLE UNDER FEDERAL STATUTES THIS CERTIFICATE OR REPORT SHALL NOT BE REPRODUCED EXCEPT IN FULL AND WITHOUT THE WRITTEN APPROVAL OF WMT&R, INC.

Testing Specialists for Aerospace, Automotive, and Material Testing Fields
 Locations in Youngstown, PA U.S.A. ~ Tel. (724) 537-3131 and
 Banbury U.K. ~ Tel. +44 (0) 1295 261211

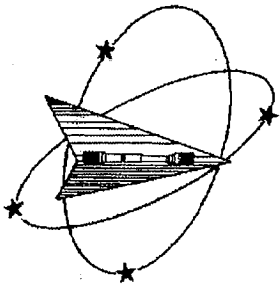

Westmoreland Mechanical Testing & Research, Inc.

P.O. Box 388

Westmoreland Drive

Youngstown, Pa. 15696-0388 U.S.A.

Telephone: 724-537-3131

Fax: 724-537-3151

Website: www.wmtr.com

WMT&R is a technical leader in the material testing industry.



621-01 & 621-02



70

November 21, 2005

CERTIFICATION

Section 2 of 2

MetalTek International

WMT&R Report No. 5-39106

P.O. No. 19386

TENSILE RESULTS: ASTM E21-05

Requirements: UTS ksi (Min 95\Max ---) 0.2% YS ksi (Min 72\Max ---) 4D Elong. % (Min 32\Max ---) Modulus Msi (Min 21\Max ---)

SOAK TIME: 5 Minutes

SPEED OF TESTING: 0.003 in./in./min., 0.05 in./min./in.

MATERIAL: Metaltek CF8MNMnMOD

DISPOSITION: Unacceptable

Specimen ID	Test Log Number	Temp. °F	UTS ksi	0.2% YS ksi	Elong %	RA %	Modulus Msi	Codes	Ult. Load lbf	0.2% YLD lbf	Orig. Dia. (in.)	Final Dia. (in.)	4D Orig. GL (in.)	4D Final GL (in.)	Orig. Area (sq. in.)	Machine Number	AIUR
G5-Z1	Q67050	-320	177.4	111.2	29	28	34.5	D	17120	10730	0.3505	0.2982	1.40	1.81	0.09648636	M9	U

AIUR: A=ACCEPTABLE, U=UNACCEPTABLE, R=REPORT

Requirements provided by MetalTek International

Reference: Tensile Results Reported on WMT&R Report 5-37644 and Hardness, Microstructure Results on WMT&R Report 5-39107

D - Failed outside middle half of gage length.

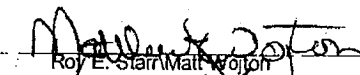
 Roy E. Star
 Technical Services Manager

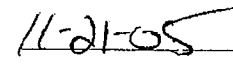
 Matt Wojton
 Tensile Supervisor

November 21, 2005

KNOWINGLY OR WILLFULLY FALSIFYING OR CONCEALING A MATERIAL FACT ON THIS FORM OR MAKING FALSE, FICTITIOUS OR FRAUDULENT STATEMENTS OR REPRESENTATIONS HEREIN COULD CONSTITUTE A FELONY PUNISHABLE UNDER FEDERAL STATUTES. THIS CERTIFICATE OR REPORT SHALL NOT BE REPRODUCED EXCEPT IN FULL WITHOUT THE WRITTEN APPROVAL OF WMT&R, INC.

Testing Specialists for Aerospace, Automotive, and Material Testing Fields

Locations in Youngstown, PA U.S.A. ~ Tel. (724) 537-3131 and

Banbury U.K. ~ Tel. +44 (0) 1295 261211

2810 Clark Avenue • St. Louis, MO 63103-2574 • (314) 531-8080 • FAX (314) 531-8085
 Chemical, Metallurgical, Mechanical, Nondestructive, Environmental Testing, Analyses and Field Service.

METALTEK INTERNATIONAL
 8600 Commercial Blvd.
 Pevely, MO 63070

August 18, 2005
 Lab No. 05P-2592
 P.O. No. 21324
 Page 1 of 3

Attention: Chuck Ruud

REPORT OF CHARPY IMPACT TEST

MATERIAL (SAMPLE ID): C5- Z1, Z2, Z3
SPECIFICATION: ASTM A 370-03a
SPECIMEN TYPE: "A" Vee Notch
SPECIMEN SIZE: 10 mm x 10 mm
TEMPERATURE OF TEST: 293°K

BASE METAL	FOOT LBS.	LATERAL EXPANSION	% SHEAR
Z1-7	136	0.083	30
Z1-8	126	0.079	30
Z1-9	128	0.081	30
Average	130	0.081	30
SAMPLE ID	FOOT LBS.	LATERAL EXPANSION	% SHEAR
Z2-7	138	0.080	30
Z2-8	119	0.065	20
Z2-9	137	0.107	40
Average	131	0.084	30
SAMPLE ID	FOOT LBS.	LATERAL EXPANSION	% SHEAR
Z3-7	139	0.099	30
Z3-8	174	0.096	40
Z3-9	156	0.089	40
Average	156	0.095	37

Identification of tested specimen provided by client.

 Karl Schmitz, Director
 Materials Testing

KS/tiv



Certificate No. 0397-02
 Certificate No. 0397-02

AN OFFICIAL COPY OF TEST REPORT WILL BE PROVIDED BY THIS LABORATORY ON REQUEST.
 NOT OFFICIAL WITHOUT THE RAISED SEAL OF ST. LOUIS TESTING LABORATORIES, INC.
 SEE REVERSE FOR CONDITIONS.



2810 Clark Avenue • St. Louis, MO 63103-2574 • (314) 531-8080 • FAX (314) 531-8085
 Chemical, Metallurgical, Mechanical, Nondestructive, Environmental Testing, Analyses and Field Service.

METALTEK INTERNATIONAL
 8600 Commercial Blvd.
 Pevely, MO 63070

August 18, 2005
 Lab No. 05P-2592
 P.O. No. 21324
 Page 2 of 3

Attention: Chuck Ruud

REPORT OF CHARPY IMPACT TEST

MATERIAL (SAMPLE ID): C5- Z1, Z2, Z3
SPECIFICATION: ASTM A 370-03a
SPECIMEN TYPE: "A" Vee Notch
SPECIMEN SIZE: 10 mm x 10 mm
TEMPERATURE OF TEST: 77°K

BASE METAL	FOOT LBS.	LATERAL EXPANSION	% SHEAR
Z1-7	78	0.047	40
Z1-8	82	0.053	40
Z1-9	82	0.050	40
Average	81	0.050	40
SAMPLE ID	FOOT LBS.	LATERAL EXPANSION	% SHEAR
Z2-7	72	0.043	40
Z2-8	75	0.039	40
Z2-9	72	0.043	40
Average	73	0.042	40
SAMPLE ID	FOOT LBS.	LATERAL EXPANSION	% SHEAR
Z3-7	93	0.053	40
Z3-8	86	0.067	50
Z3-9	82	0.065	40
Average	87	0.062	43

Identification of tested specimen provided by client.

 Karl Schmitz, Director
 Materials Testing

KS/tlv



Certificate No. 035003
 Certificate No. 0397-02

AN OFFICIAL COPY OF TEST REPORT WILL BE PROVIDED BY THIS LABORATORY ON REQUEST.
 NOT OFFICIAL WITHOUT THE RAISED SEAL OF ST. LOUIS TESTING LABORATORIES, INC.
 SEE REVERSE FOR CONDITIONS.



2810 Clark Avenue • St. Louis, MO 63103-2574 • (314) 531-8080 • FAX (314) 531-8085
Chemical, Metallurgical, Mechanical, Nondestructive, Environmental Testing, Analyses and Field Service.

METALTEK INTERNATIONAL
8600 Commercial Blvd.
Pevely, MO 63070

August 18, 2005
Lab No. 05P-2592
P.O. No. 21324
Page 3 of 3

Attention: **CHUCK RUUD**

REPORT OF MECHANICAL TESTS

SAMPLE ID: C5- Z1, Z2, Z3

Sample ID	Original Area Sq. Inches	Reduced Area Sq. Inches	Reduction in Area %	Modulus of Elasticity	Yield Strength PSI	Tensile Strength PSI	Elongation (2.0" Gage Length)	
							in.	%
Z1	0.1963	0.1041	47.0	28.4 Msi	41500	92900	1.11	55.0
Z2	0.1893	0.1012	46.5	27.7 Msi	37700	84400	1.04	52.0
Z3	0.1909	0.1052	44.9	25.9 Msi	37100	83700	1.34	67.0

Round, reduced section tensiles

Yield taken at .2% offset

Tested in accordance with ASTM A 370-03a

Identification of tested specimens provided by the client.

KS/kss

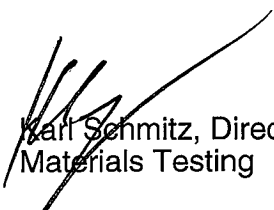
Karl Schmitz, Director
Materials Testing



Certificate No. 0397-02
Certificate No. 0397-02

AN OFFICIAL COPY OF TEST REPORT WILL BE PROVIDED BY THIS LABORATORY ON REQUEST.
NOT OFFICIAL WITHOUT THE RAISED SEAL OF ST. LOUIS TESTING LABORATORIES, INC.
SEE REVERSE FOR CONDITIONS.



C-5 Coil Weld Map – Metal Tek

Map of all major welds exceeding 20% of wall, over 1 inch or over 10² inches

Defect Number	Drawing View	Length (inches)	Width (inches)	Depth (inches)
1	Right	8	7	3
2	Right	23	16	3
3	Right	3	3	2
4	Right	7 ½	5	2
5	Right	24	13	¾
6	Left	9	2	Thru
7	Left	21	4	Thru
8	Left	16	1 ½	¾
9	Left	14	9	1 ¼
10	Left	7	4	Thru
11	Right	7 ½	4	Thru
12	Right	10 ½	1 ½	¾
13	Right	6	4	1 ¼
14	Right	5	1 ¾	1 ½
15	Right	4	4	Thru
16	Right	4	2	Thru
17	Right	6	4	1
18	Right	12	4	Thru
19	Right	18	4	2
20	Right	15	2	2
21	Right	14	3	¾
22	Right	16	6	1
23	Right	5 ¼	4	¾
24	Right	7	4	¼
25	Right	6	4	3
26	Right	9	3	1 ½
27	Right	3	2	1 ½
28	Right	4	5	1
29	Right	4	3	1 ¼
30	Right	6	5 ½	¾
31	Right	10	7	Thru
32	Right	2	2	1
33	Bottom	4	2 ½	2
34	Bottom	5 ½	2	2
35	Bottom	11	4	¾

C-5 Coil Weld Map – Metal Tek

Map of all major welds exceeding 20% of wall, over 1 inch or over 10² inches

Defect Number	Drawing View	Length (inches)	Width (inches)	Depth (inches)
36	Back	7	3	1 ½
37	Back	4	3	2
38	Back	16	4	1
39	Back	9	4 ¼	¾
40	Back	5	5	¾
41	Back	5	1 ½	1 ½
42	Back	22 ½	1	¾
43	Back	5	3	1
44	Back	7	3	1
45	Front	4	2	Thru
46	Front	7 ½	3	2
47	Left	31	12	1
48	Left	32 ¾	6	¾
49	Left	18	1	¼
50	Left	14	7	1
51	Left	17	1	Thru
52	Left	7	5 ½	¾
53	Left	21	6	3
54	Left	9	1 ½	¼
55	Left	13	4	Thru
56	Left	9	2 ½	1 ½
57	Left	6	6	Thru
58	Left	2	2	2
59	Left	10	6	1
60	Left	22	8	1
61	Left	24	1 ½	¾
62	Left	28	3	2
63	Left	15	4 ½	1
64	Left	21	7	1
65	Left	3	2 ½	2 ½
66	Left	13	5	Thru
67	Left	4	4	2 ½
68	Left	8	2	1 ½
6	Left	4	4	2
70	Left	15	1	½
71	Left	4	2 ½	3
72	Left	9	4 ½	½

C-5 Coil Weld Map – Metal Tek

Map of all major welds exceeding 20% of wall, over 1 inch or over 10² inches

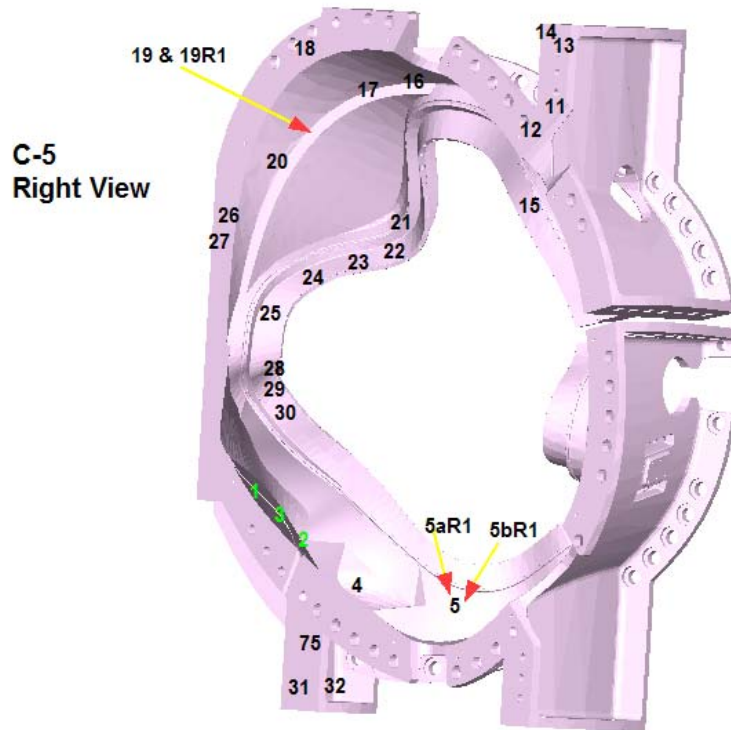

C-5 Coil Weld Map – Metal Tek

Map of all major welds exceeding 20% of wall, over 1 inch or over 10² inches

C-5
Front View



C-5 Coil Weld Map – Metal Tek

Map of all major welds exceeding 20% of wall, over 1 inch or over 10² inches

C-5
Back View

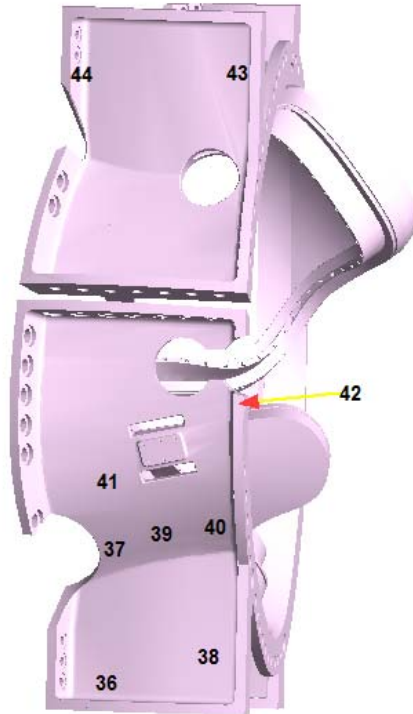

C-5 Coil Weld Map – Metal Tek

Map of all major welds exceeding 20% of wall, over 1 inch or over 10² inches

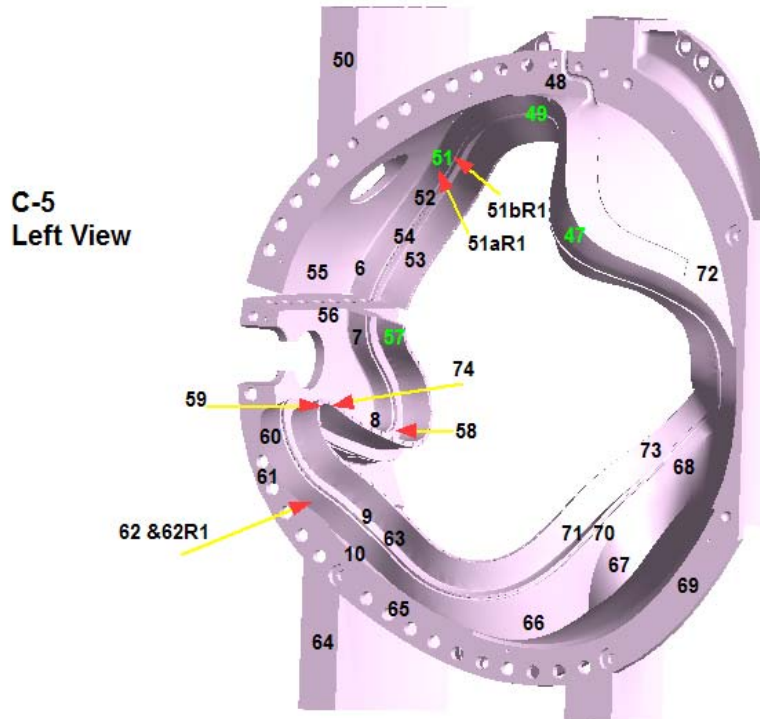

C-5 Coil Weld Map – Metal Tek

Map of all major welds exceeding 20% of wall, over 1 inch or over 10² inches

Top View

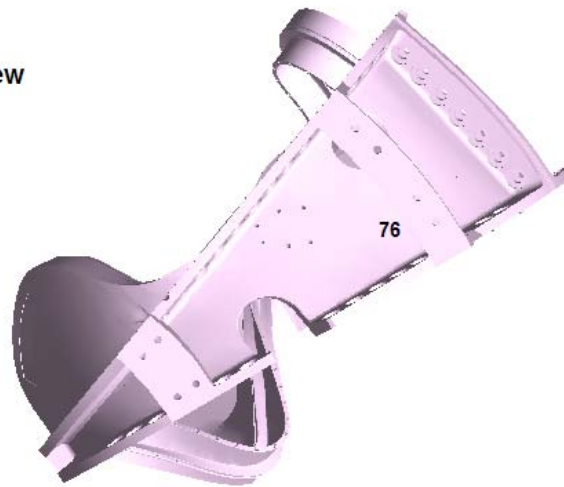

C-5 Coil Weld Map – Metal Tek

Map of all major welds exceeding 20% of wall, over 1 inch or over 10² inches

C-5
Bottom View

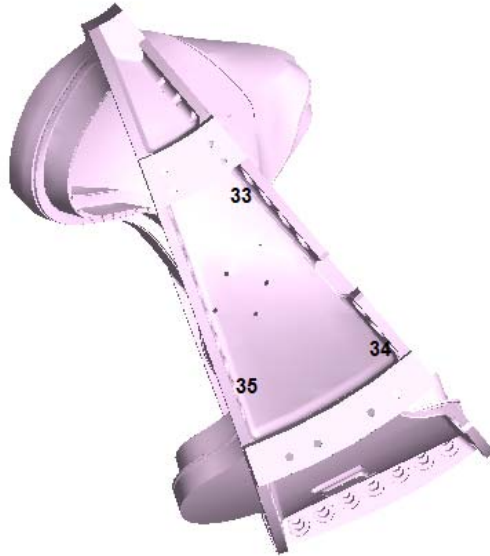



RADIOGRAPHIC STANDARD SHOOTING SKETCH

Customer <u>E. I. O.</u>	Pattern Number <u>MCWF-C5</u>
Material <u>CF8MNMN MOD</u>	Traceability Number
Film Manufacturer <u>FUJI</u>	Source Number <u>E060 22.7 CI</u>
IQI LEVEL <u>2-2T</u> From CQP 401 <input checked="" type="checkbox"/> Other (Specify, E.G. 2-4T, 2-1T) <u>N/A</u>	

Exposures (views)	83-84	103-104	104-105	109-110	H-I	X-Y							
Thickness (IN.)	1 1/2" → 3"	2 3/4"			3" → 6"								
S/F Distance (IN.)	20"												
Penetrator	3060 4060	50 x2			60x2 120x2								
Time (MIN.)	15min	8min 30sec		16min	1hr 45min								
Focal Spot (IN.)	.125												
Film Size (IN.)	14x17												
Screen Size (Pb) Front/Back	.01												
S.W.E./D.W.E.	SWE												
S.W.V/D.W.V.	SWV												
Film Type	29 5980	80x2		59/80	29x2 5980								
Acceptance Standard	MSS-SP-54												
Severity Level	See SPEC.												

Shooting Sketch (Use Additional Pages as Needed)

Technique Prepared By: Ron Kelley Level: II Date: 11-7-05
 Technique Approved By: _____ Level: _____ Date: _____

RADIOGRAPHIC STANDARD SHOOTING SKETCH

Customer Energy Industries of Ohio	Pattern Number SE-141-073 C skin
Material CF8MNMN-MOD	Traceability Number
Film Manufacturer Fuji	Source Number C060 24.7 ci
IQI LEVEL 2-2T From CQP 401 <input checked="" type="checkbox"/> Other (Specify, E.G. 2-4T, 2-1T) N/A	

Exposures (views)	A	B	C	D														
Thickness (IN.)	3 7/8"	→																
S/F Distance (IN.)	24"	→																
Penetrator	50	→																
Time (MIN.)	22 min	→																
Focal Spot (IN.)	.1	→																
Film Size (IN.)	14X17	→																
Screen Size (Pb)	.01	→																
Front/Back	SWE	→																
S.W.E./D.W.E.	SWE	→																
S.W.V./D.W.V.	SWV	→																
Film Type	80	→																
Acceptance Standard	E186	→																
Severity Level	III	→																

Shooting Sketch (Use Additional Pages as Needed)

Use spec. MSS-SP-54

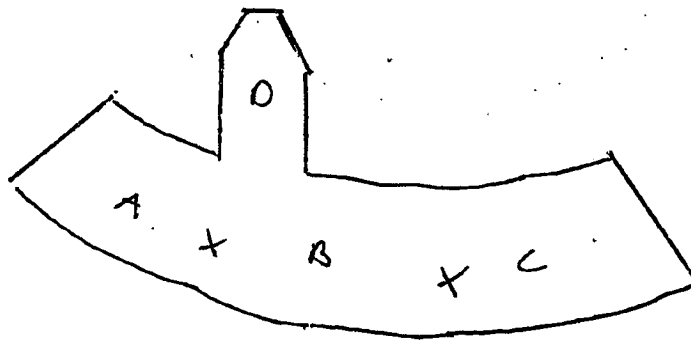

TYP. Source Placement

TYP. Film Placement

Technique Prepared By: RON Kelley
 Technique Approved By: RS

Level: II
 Level: III

Date: 9-9-05
 Date: 9/10/05

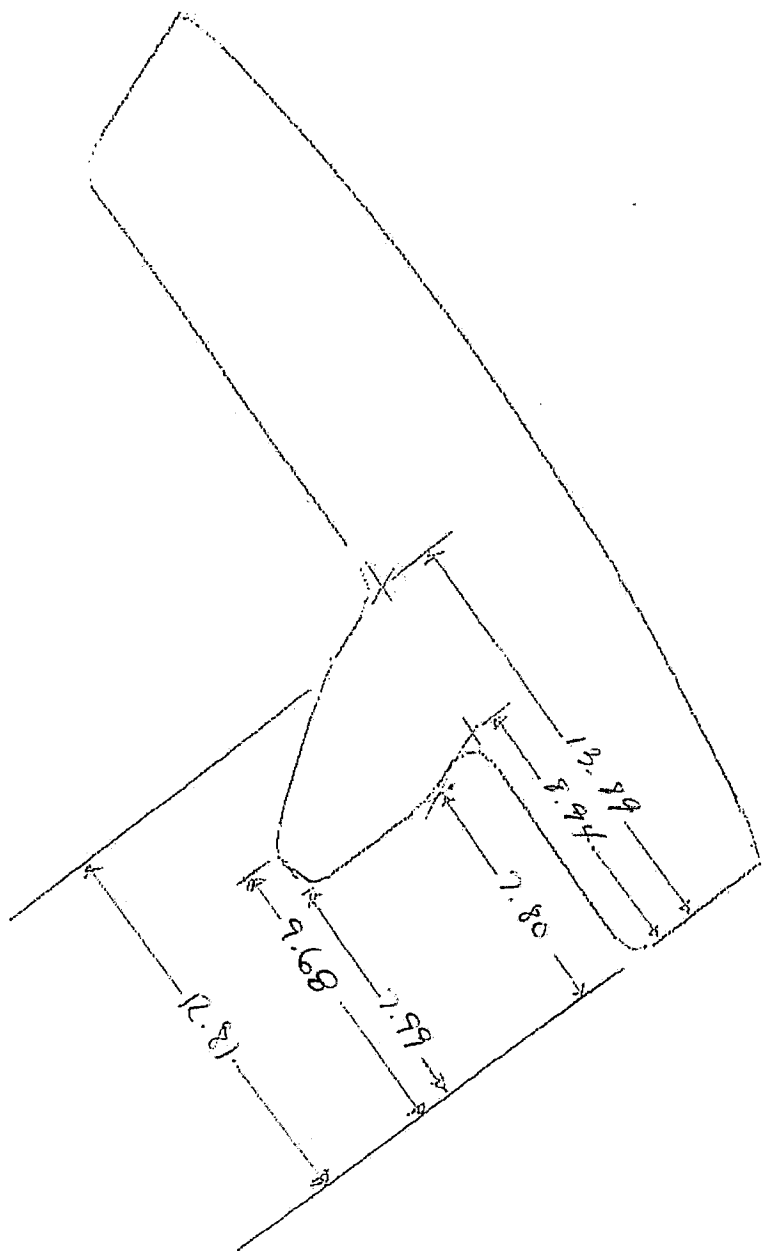

PAGE 2 OF 2.
 SHIM SE 141-073 (5)

Q A

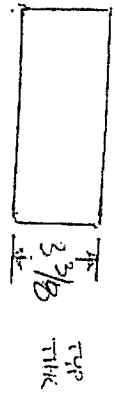

SECT A-A

HWM SE 141-073
 SKETCH 9/12/05
 PAGES 1 OF 2

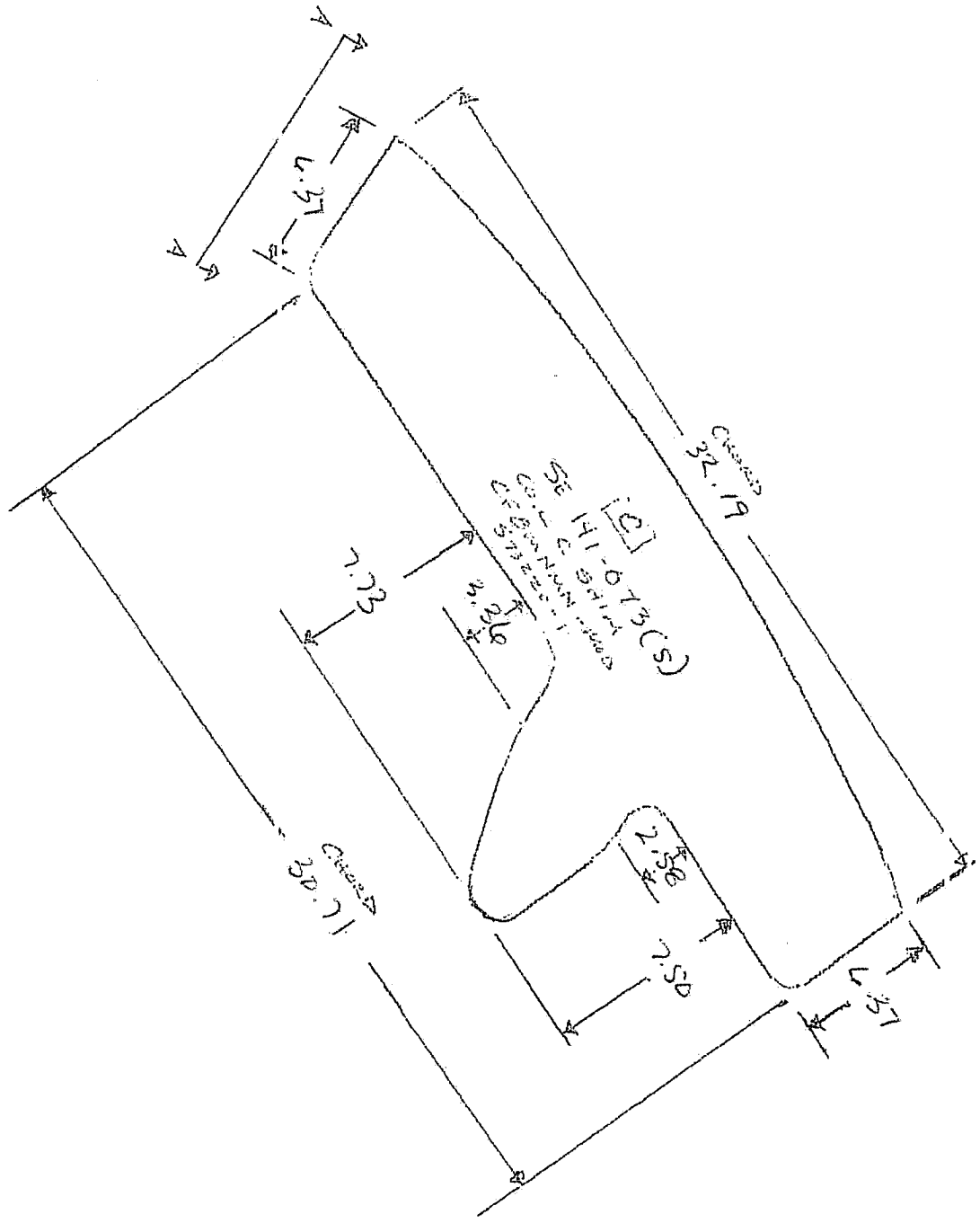

TEAM COOPERHEAT-MQS, INC.

CERTIFIED RADIOGRAPHIC INSPECTION REPORT

FORM 6061-RT- 002 Rev.2

5512 W. State St. Milwaukee, WI 53208 Tel:(414)771-3060 Fax:(414)771-9481 (800)818-6403 www.cooperheat-mqs.com

CUSTOMER		DATE	WORK ORDER NO.
NAME <u>METAL TEK INTERNATIONAL</u>		<u>8/31/2005</u>	361-02500-1
ADDRESS <u>8600 COMMERCIAL BLVD</u>		P.O. NUMBER	XRAY X
CITY <u>PEVELY</u> STATE <u>MO</u> ZIP <u>63070</u>		21818	GAMMA
PROCEDURE SPECIFICATION	ACCEPTANCE CRITERIA	SHEET ____ OF ____	
ASTM E94-93	MSS-SP-54-1999		

PART NUMBER	Serial No	View	No Apparent Indications		Dross		Incomplete Penetration		Shrinkage		Film Artifacts		REMARKS
			Acceptable	Rejected	Inclusion	Porosity	Lack of Fusion	Gas Cracks	Hot Tears	Under cut	Surface		
MCWF-C-5		1-2		R									
		2-3	✓										
E.I.O. C040851		3-4	✓										
		4-5		R									
MS172810		5-6		R									
		7-8	✓									✓	
		8-9	✓							1-2		✓	
		9-10	✓										
		11-12	✓										
		12-13	✓										
		13-14	✓		2								
		15-16	✓										
		16-17	✓										
		18-19	✓										
		19-20	✓										
		20-21	✓										
		21-22		R									
		23-24	✓										
		24-25	✓										
		26-27	✓										
		27-28	✓										
		29-30	✓									✓	
		30-31	✓									✓	
		32-33	✓										
		33-34	✓									✓	

NO. ACCEPTED <u>0</u>	NO. REJECTED <u>1</u>	MQS TECH. NO. 12970	SHT.	REV. 1
COMMENTS		CUST. RSS NO.	SHT.	REV.
		REVIEWER <u>John Petroske</u>		
		CERTIFIED NDT LEVEL (RT)		
		John Petroske RT II Exp. 01/08		

TEAM COOPERHEAT-MQS, INC.

CERTIFIED RADIOGRAPHIC INSPECTION REPORT

FORM 6061-RT- 002 Rev.2

5512 W. State St. Milwaukee, WI 53208 Tel:(414)771-3060 Fax:(414)771-9481 (800)818-6403 www.cooperheat-mqs.com

CUSTOMER		DATE	WORK ORDER NO.
NAME METAL TEK INTERNATIONAL		8/31/2005	361-02500-1
ADDRESS 8600 COMMERCIAL BLVD		P.O. NUMBER	XRAY X
CITY PEVELY STATE MO ZIP 63070		21818	GAMMA
PROCEDURE SPECIFICATION	ACCEPTANCE CRITERIA	SHEET ____ OF ____	
ASTM E94-93	MSS-SP-54-1999		

PART NUMBER	Serial No	View	No Apparent Indications		Incomplete Penetration		Shrinkage		Film Artifacts		REMARKS
			Acceptable	Rejected	Dross or Slag	Porosity	Lack of Fusion	Gas Cracks	Hot Tears	Under Surface	
MCWF-C-5	35-36		✓								✓
	36-37			R	5			R			
E.I.O. C040851	38-39		✓								✓
	39-40		✓				1				✓
MS172810	41-42			R			3-4		R		✓
	42-43			R					R		✓
	44-45			R			3				
	45-46		✓		1						✓
	47-48			R			3-4		R		✓
	48-49			R			4		R		✓
	49-50-51			R			3-4		R		✓
	52-53			R				4			
	53-54		✓								
	54-55		✓								
	55-56		✓								
	56-57		✓								
	57-58		✓								
	58-59		✓		1						
	59-60		✓		1		2				✓
	60-61		✓				2				✓
	62-63		✓				2				
	63-64		✓								
	65-66		✓								
	67-68		✓					2			
	68-69		✓					3			

NO. ACCEPTED	0	NO. REJECTED	1	MQS TECH. NO.	12970	SHT.	REV. 1
--------------	---	--------------	---	---------------	-------	------	--------

COMMENTS	REVIEWER	CERTIFIED NDT LEVEL (RT)
V64 not included. This view was only shot for a dig out in this Area on previous castings.	<i>John Petroske</i>	John Petroske RT II Exp. 01/08

TEAM COOPERHEAT-MQS, INC.

CERTIFIED RADIOGRAPHIC INSPECTION REPORT

FORM 6061-RT- 002 Rev.2

5512 W. State St. Milwaukee, WI 53208 Tel:(414)771-3060 Fax:(414)771-9481 (800)818-6403 www.cooperheat-mqs.com

CUSTOMER		DATE	WORK ORDER NO.
NAME METAL TEK INTERNATIONAL		8/31/2005	361-02500-1
ADDRESS 8600 COMMERCIAL BLVD		P.O. NUMBER	XRAY X
CITY PEVELY STATE MO ZIP 63070		21818	GAMMA
PROCEDURE SPECIFICATION	ACCEPTANCE CRITERIA	SHEET ____ OF ____	
ASTM E94-93	MSS-SP-54-1999		

PART NUMBER	Serial No	View	No Apparent Indications		Dross		Incomplete Penetration		Shrinkage		Film Artifacts		REMARKS
			Acceptable	Rejected	Inclusion	or Porosity	Lack of Fusion	Gas Cracks	Hot Tears	Under cut	Surface		
MCWF-C-5	69-70	✓										✓	
	71-72	✓							2-3				
E.I.O. C040851	72-73	✓							2				
	73-74	✓										✓	✓
MS172810	74-75	✓										✓	
	75-76	✓										✓	
	76-77	✓							1			✓	
	78-79	✓							2			✓	
	79-80	✓										✓	
	80-81	✓							3			✓	
	81-82				R				3-4		R		
	83-84				R				3			✓	
	85-86				R				3-4				
	86-87	✓											✓
	87-88				R				2		R	✓	
	88-89				R						R		
	90-91				R				5			✓	
	92-93				R				5			✓	
	94	✓										✓	
	95	✓											✓
	96-97				R	R						✓	
	97-98				R						R		
	98-99	✓											✓
	100-101	✓										✓	
	101-102	✓											✓

NO. ACCEPTED	NO. REJECTED	MQS TECH. NO.	SHT.	REV. 1
0	1	12970		
COMMENTS		CUST. RSS NO.	SHT.	REV.
		REVIEWER		
		CERTIFIED NDT LEVEL (RT)		
		John Petroske RT II Exp. 01/08		

TEAM COOPERHEAT-MQS, INC.

CERTIFIED RADIOGRAPHIC INSPECTION REPORT

FORM 6061-RT- 002 Rev.2

5512 W. State St. Milwaukee, WI 53208 Tel:(414)771-3060 Fax:(414)771-9481 (800)818-6403 www.cooperheat-mqs.com

CUSTOMER		DATE	WORK ORDER NO.
NAME <u>METAL TEK INTERNATIONAL</u>		<u>8/31/2005</u>	<u>361-02500-1</u>
ADDRESS <u>8600 COMMERCIAL BLVD</u>		P.O. NUMBER	XRAY X
CITY <u>PEVELY</u> STATE <u>MO</u> ZIP <u>63070</u>		<u>21818</u>	GAMMA
PROCEDURE SPECIFICATION	ACCEPTANCE CRITERIA	SHEET ____ OF ____	
<u>ASTM E94-93</u>	<u>MSS-SP-54-1999</u>		

PART NUMBER	Serial No	View	No Apparent Indications		Incomplete Penetration		Shrinkage			Film Artifacts			REMARKS
			Acceptable	Rejected	Dross or Slag	Porosity	Lack of Fusion	Gas Cracks	Hot Tears	Under cut	Surface		
MCWF-C-5	102-103		✓										
	103-104			R						R			
E.I.O. C040851	104-105			R	5					R			
	106-107			R						R			
MS172810	107-108		✓									✓	
	108-109			R						R			
	109-110			R	5					R			
	111-112		✓										
	112-113			R	5								
	114-115		✓										
	115-116		✓										
	116-117			R						R			

NO. ACCEPTED <u>0</u>	NO. REJECTED <u>1</u>	MQS TECH. NO. <u>12970</u>	SHT. <u>1</u>	REV. <u>1</u>
COMMENTS		CUST. RSS NO.	SHT.	REV.
		REVIEWER <u>John Petroske</u>		
		CERTIFIED NDT LEVEL (RT)		
		John Petroske RT II Exp. 01/08		

TEAM COOPERHEAT-MQS, INC.

CERTIFIED RADIOGRAPHIC INSPECTION REPORT

FORM 6061-RT- 002 Rev.2

5512 W. State St. Milwaukee, WI 53208 Tel:(414)771-3060 Fax:(414)771-9481 (800)818-6403 www.cooperheat-mqs.com

CUSTOMER		DATE	WORK ORDER NO.
NAME METAL TEK INTERNATIONAL		8/31/2005	361-02500-1
ADDRESS 8600 COMMERCIAL BLVD		P.O. NUMBER	XRAY X
CITY PEVELY STATE MO ZIP 63070		21818	GAMMA
PROCEDURE SPECIFICATION	ACCEPTANCE CRITERIA	SHEET ____ OF ____	
ASTM E94-93	MSS-SP-54-1999		

PART NUMBER	Serial No	View	No Apparent Indications		Dross		Incomplete Penetration		Shrinkage		Film Artifacts		REMARKS
			Acceptable	Rejected	Inclusion	Porosity	Lack of Fusion	Gas Cracks	Hot Tears	Undercut	Surface		
MCWF-C-5		AB		R					5				
		B-C		R					5				
E.I.O. C040851		C-D		R					5				
		D-E	✓						2				
MS172810		E-F	✓									✓	
		F-G	✓						3				
		G-H		R					5				
		H-I		R					5				
		I-J		R					5				
		J-K	✓						3				
		K-L		R					3		R		
		L-M		R					3		R		
		M-N		R					5				
		N-O	✓						3				
		O-P	✓						2				
		P-Q	✓						2				
		Q-R	✓						3				
		R-S	✓						1				
		S-T	✓										
		T-U	✓										
		U-V	✓						2-3				
		V-W		R					5				
		W-X		R					5				
		X-Y		R					5				
		Y-Z		R					4-5			✓	

NO. ACCEPTED	NO. REJECTED	MQS TECH. NO.	SHT.	REV. 1
0	1	12970		
COMMENTS		CUST. RSS NO.	SHT.	REV.
		REVIEWER		
		CERTIFIED NDT LEVEL (RT)		
		John Petroske RT II Exp. 01/08		

TEAM COOPERHEAT-MQS, INC.

CERTIFIED RADIOGRAPHIC INSPECTION REPORT

FORM 6061-RT- 002 Rev.2

5512 W. State St. Milwaukee, WI 53208 Tel:(414)771-3060 Fax:(414)771-9481 (800)818-6403 www.cooperheat-mqs.com

CUSTOMER		DATE	WORK ORDER NO.
NAME METAL TEK INTERNATIONAL		10/13/2005	361-02646
ADDRESS 8600 COMMERCIAL BLVD		P.O. NUMBER	XRAY X
CITY PEVELY STATE MO ZIP 63070			GAMMA
PROCEDURE SPECIFICATION ASTM E94-93	ACCEPTANCE CRITERIA MSS-SP-54-1999	SHEET ____ OF ____	

PART NUMBER	Serial No	View	No Apparent Indications		Dross		Incomplete Penetration		Shrinkage			Film Artifacts		REMARKS
			Acceptable	Rejected	Included	or Porosity	Lack of Fusion	Gas Cracks	Hot Tears	Under cut	Surface			
MCWF-C5	5	1-2	✓		1-2				1-2					
	21	4-5	✓										✓	
E.I.O. C040851		5-6	✓						2					
		21-22	✓											
M172810		36-37	✓											
		41-42	✓						1-2				✓	
		42-43	✓										✓	
		44-45	✓						2				✓	✓
		47-48	✓						1				✓	✓
		48-49	✓										✓	✓
	49	50-51	✓						2					
		52-53	✓										✓	✓
		81-82	✓		1-2								✓	✓
		83-84		R						4				
		85-86	✓		1-2								✓	✓
		87-88	✓										✓	
		88-89	✓							1			✓	
		90-91	✓										✓	
		92-93	✓						1-2				✓	
		96-97	✓										✓	
		97-98	✓		1-2									
	103	104		R							R		✓	
	104	105		R							R		✓	
	106	107	✓											
	108	109	✓										✓	

NO. ACCEPTED	Φ	NO. REJECTED	1	MQS TECH. NO.	12970	SHT.	REV.
COMMENTS				CUST. RSS NO.		SHT.	REV.
				REVIEWER	<i>John Petroske</i>		
				CERTIFIED NOT LEVEL (RT)			
				John Petroske RT II Exp. 01/08			

TEAM COOPERHEAT-MQS, INC.

CERTIFIED RADIOGRAPHIC INSPECTION REPORT

FORM 6061-RT- 002 Rev.2

5512 W. State St. Milwaukee, WI 53208 Tel:(414)771-3060 Fax:(414)771-9481 (800)818-6403 www.cooperheat-mqs.com

CUSTOMER		DATE	WORK ORDER NO.
NAME METAL TEK INTERNATIONAL		10/13/2005	361-02646
ADDRESS 8600 COMMERCIAL BLVD		P.O. NUMBER	XRAY X
CITY PEVELY STATE MO ZIP 63070			GAMMA
PROCEDURE SPECIFICATION ASTM E94-93	ACCEPTANCE CRITERIA MSS-SP-54-1999	SHEET ____ OF ____	

PART NUMBER	Serial No	View	No Apparent Indications		Dross		Incomplete Penetration		Shrinkage			Film Artifacts		REMARKS
			Acceptable	Rejected	Inclusion	or Porosity	Lack of Fusion	Gas Cracks	Hot Tears	Under cut	Surface			
MCWF-C5	5	AB	✓											
	RI	B-C	✓											
E.I.O. C040851		C-D	✓											
		G-H	✓											
M172810		H-I			R						4-5		✓	Sec 83-84
		I-J	✓								J			
		K-L	✓								2-3			
		L-M	✓								1-2			
		M-N	✓								1			
		V-W	✓								2			
		W-X	✓								2			
		Y-Z	✓											
		X-Y			R						4-5		✓	
		Z-AA	✓											
		BB	✓											
		CC-DD	✓								1		✓	
		DD-A	✓								1			

NO. ACCEPTED	NO. REJECTED	MQS TECH. NO.	SHT.	REV.
0	1	12970		
COMMENTS		CUST. RSS NO.	SHT.	REV.
V-W, WX There is room for only 1 1/2 open in these views				
		REVIEWER		
		John Petroske		
		CERTIFIED NOT LEVEL (RT)		
		John Petroske RT II Exp. 01/08		

MetalTek

INTERNATIONAL

RADIOGRAPHIC INTERPRETATION REPORT

CUSTOMER E.I.O	PURCHASE ORDER NUMBER PPPI -FP-LTS-2	DATE 11-7-05	CONTROL NO. 40851	PAGE 106/1							
PART NO. MCWFC-5	SPECIFICATION E44/E186	CLASS see spec	TOTAL PIECES 1	PIECES ACCEPTED 1							
RADIOGRAPHED BY: Midsert/Kelley		INTERPRETED BY: At Kelley		ASNT LEVEL II							
FILM TYPE 29/59/80	MATERIAL CF8M/INM MOD	ISOTOPE IRIDIUM 192 COBALT 60 V									
		CODE ASTM E94 V ASME MIL-STD-453									
M172810	V I E W	P E N E	A C C E P T	R E J E C T	S H R I N K	I N C L U S I O N	P O R O S I T Y	L I N E A R	S U R F A C E	L O F / L O P	COMMENTS
R2	83-84	30/40	/				2				
	103-104	50	/			1	1		/		
	104-105	↓	/		1	1			/		
	109-110	↓		X						X	
	H-I	60/120	/		2	1					
	X-Y	6		X	X						
R3	109-110	50	/			1	1		/		
	X-Y	60/120	/			1	1		/		

MetalTek

INTERNATIONAL

4

RADIOGRAPHIC INTERPRETATION REPORT

CUSTOMER E.I.O.		PURCHASE ORDER NUMBER PPPL-FA-LTS-2			DATE 11-8-05		CONTROL NO. 40851		PAGE 1 of 1		
PART NO. SE-141-073-5		SPECIFICATION E186		CLASS See Spec		TOTAL PIECES 1		PIECES ACCEPTED 1			
RADIOGRAPHED BY: Kelley				INTERPRETED BY: Kelley			ASNT LEVEL III				
FILM TYPE 80	MATERIAL CFBMMN NPD			ISOTOPE IRIDIUM 192 COBALT 60 /				CODE ASTM E94 / ASME MIL-STD-453			
	V I E W	P E N E	A C C E P T	R E J E C T	S H R I N K	I N C L U S I O N	P O R O S I T Y	L I N E A R	S U R F A C E	L O F / L O P	C O M M E N T S
MS73220-2											
Skim 5	A	50	/						/		
	B		/		1	1			/		
	C		/								
	D		/			1					

E10 8-13-05

MCWF-C5 COIL

172810 -1

1 Pc.

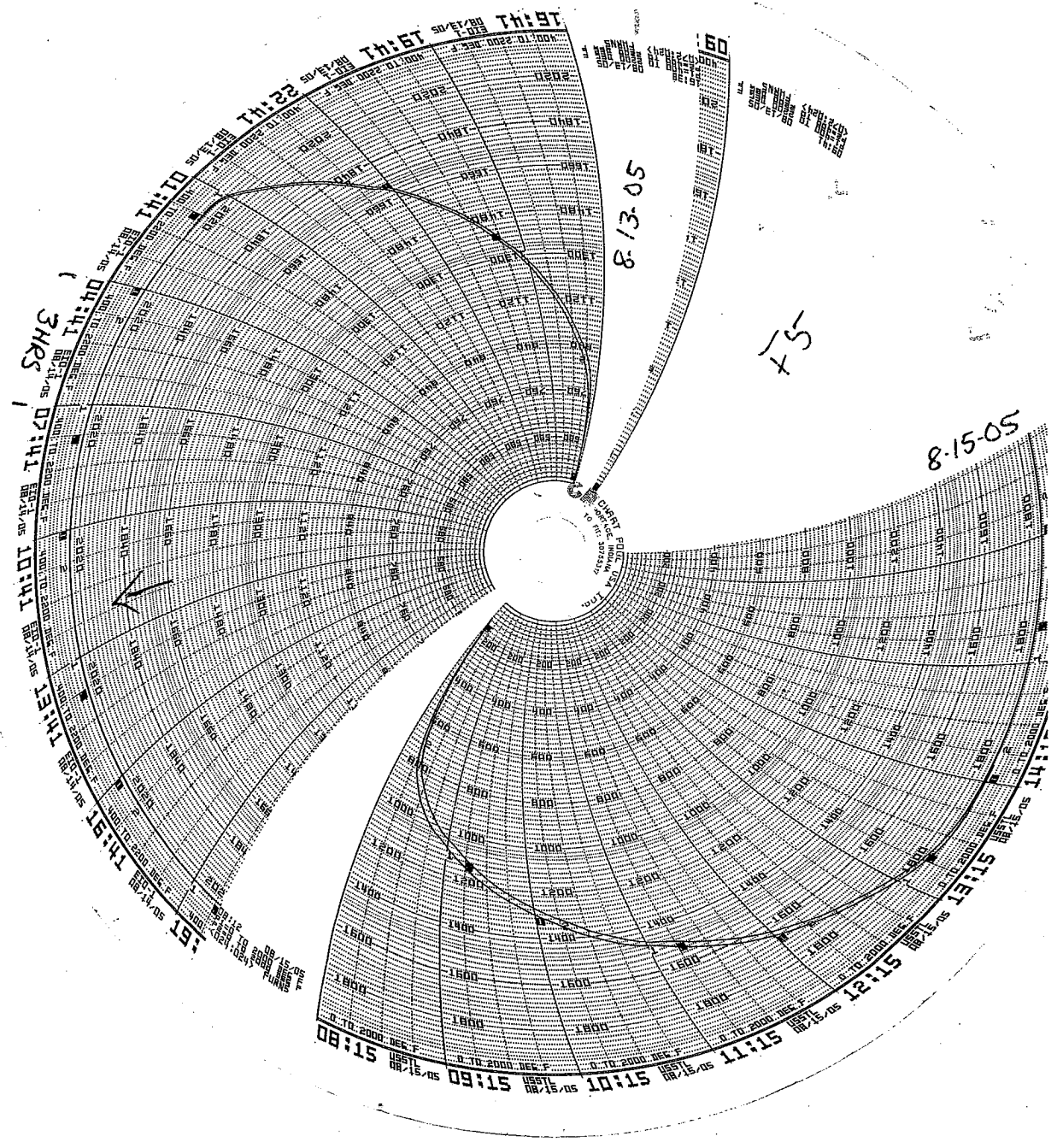

E10 11-14-05
MCWF-C5 coil
172810-1
1 Pc.

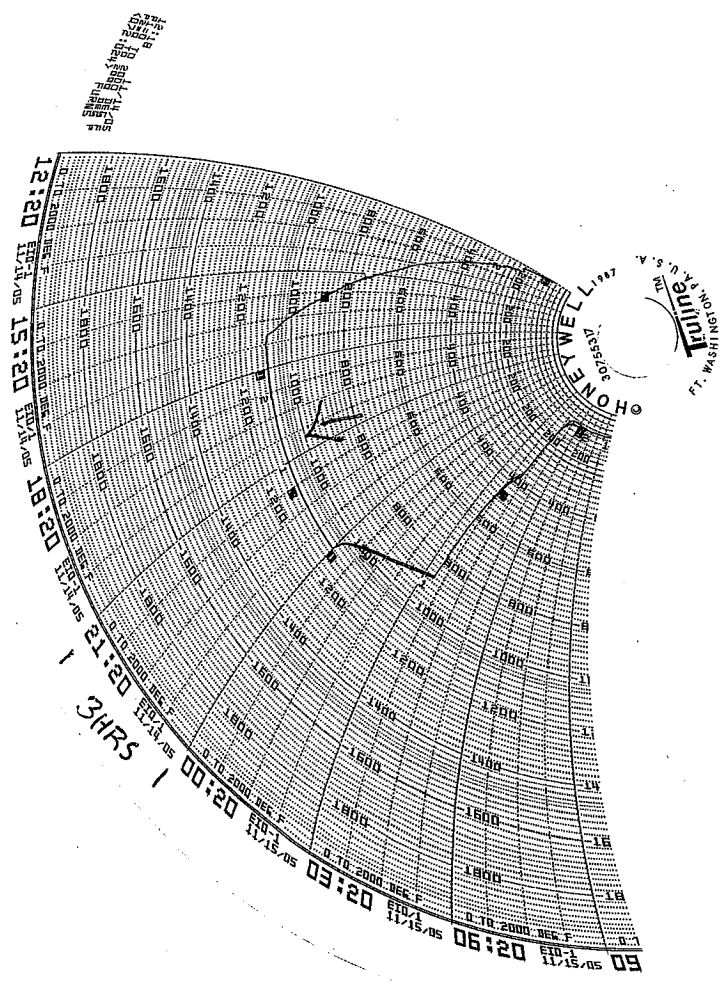

Energy Industries of Ohio
 Manufacturing and Test Sequence (MTS) Serial Number C-5 Coil

1 OF 11 CO# 40851 Dated 3-9-05 Revision: Rev 8 Dated Issued:7-29-05

OPER. #	STATION	DESCRIPTION OF PROCESS	Name	Date
10	QUALITY RELEASE	REVIEW AND APPROVE MTS. RECEIVED APPROVAL FROM EIO ON _8-3-05 FROM _Pete D._ SIGNED QUALITY MANAGER	<i>CD</i>	
15	PATTERN NPAT SOP 0100REV2	APPLY APPROPRIATE PART NUMBER, SERIAL NUMBER, AND FOUNDRY MARK, TO THE PATTERN. CAST ON TEST BARS AND CAST ON BLOCKS (extra 3"x3"x1" specimens) REQUIRED, ID AS TO COIL NUMBER AND ZONE LOCATION.	<i>KM</i>	<i>8/3</i>
20	COREMAKE CORE SOP 0100 REV 6 CALIBRATION PER CORE SOP 0200R4/0300R6	MAKE CORES IN SAND MIXTURES AS DESCRIBED BY METALTEK ENGINEERING AND VERIFIED IN MODELING TRIALS. METALTEK CORE SOP 0100 REV 6) CORE WASH WITH ZIRCONIUM CORE WASH. (CALIBRATION OF EQUIPMENT REQUIRED PER CORE SOP 0200,R4 / 0300,R6) VERIFY COUNT AND INSPECT.	<i>BC</i>	<i>8/4/05</i>
30	MOLD MOLD SOP 0400 REV 8 CALIBRATION PER MOLD SOP 0900 REV 5 PREPARATION PER MOLD SOP 1100R2/1200R2/1300R1 SAND TESTING PER MOLD SOP 1400R2/1500R3/1600R2	MOLD PER WORK INSTRUCTIONS IN MAPICS ROUTING AND SOPS REFERENCED. ENGINEER OF RECORD - ROGER BROMAN, CONSULT ON MOLD-RELATED CONCERNS. MOLD MATERIALS REQUIRED PER MAPICS BOM. NOTIFY ENGINEER OF ANY SUBSTITUTIONS.	<i>BC</i>	<i>8/8/05</i>
40	POUR MELT SOP 0100R5 MELT SOP 0700R2 MELT SOP 0600R2	METAL MUST BE AOD REFINED OR AOD INGOT. VIRGIN METAL ADDITIONS ALLOWED. RECORD POURING TEMPERATURE: <u>2745</u> CASTING POURED AT: <u>330 AM</u> DATE: <u>8/08/05</u> HEAT #'s: <u>30441, 30445</u> ELAPSED POUR TIME <u>25 min</u> KEEL BLOCKS POURED: <u>NA</u> Sample from ladle to be analyzed for final chemical analysis and reported on material certifications. Sample Taken by: <u>J. Wilson</u> Analyzed: <u>G. Hunt</u> Date: <u>8/8</u>	<i>JWG</i>	<i>8/12/05</i>
50	MELT SOP 0800R2	SHAKEOUT	<i>CA</i>	<i>8/11</i>

Energy Industries of Ohio
 Manufacturing and Test Sequence (MTS) Serial Number C-5 Coil
 2 OF 11 CO# 40851 Dated 3-9-05 Revision: Rev 8 Dated Issued:7-29-05

60	ARC RISE SOP 0100R1	REMOVE RISERS AS DIRECTED BY SUPERVISOR.	JC	8/19
70	HEAT TREAT HEAT SOP 0103R5	SOLUTION ANNEAL. MAKE SURE TO BLOCK ALL FLANGES OF FORM AND RACETRACK TO MINIMIZE CREEP DISTORTION. Soak Temp: 2050F, Soak Time: 4HR + 1/2 HR/IN, Quench Type: Air Cool MAKE SURE TEST MATERIAL IS PLACED IN THE CORRECT ZONE.	RJ	8/14/05
75	PHYSICAL TESTING	OBTAIN TEST SPECIMENS AND SUBMIT FOR PHYSICAL TESTING. REPORT RESULTS AS PART OF STEP 510.	WH	8/15/05
NOTE		THE ORDER OF CLEANING PROCESSES MAY BE ALTERED DUE TO CAPACITY CONSTRAINTS. HOLD POINTS AND COMPLIANCE WILL NOT BE COMPROMISED. EIO WILL BE ADVISED OF ALL CHANGES THAT MAY RESULT IN A REQUEST FOR DEVIATION FROM REQUIREMENTS.		
80	GRIND GSAW SOP 0100R3	SWING GRIND TO REMOVE RISER REMAINS AND FLASH IF REQUIRED.	JLC	8/16/05
85	GRIND GCHI SOP 0100R2	CHIP AND HAD GRIND SURFACE OF PART AS REQUIRED FOR CONTOUR.	CAK	8/22/05
90	SAND BLAST BLAS SOP 0100R6	SANDBLAST (REMOVE ALL BLAST MATERIAL FROM CASTING) SANDBLASTING WILL BE DONE USING RECYCLED SHARP ANGULAR AGGREGATE.	MTW	8/23/05
NOTICE	WITNESS NOTIFICATION	PROVIDE NOTICE TO EIO AND DCMA AT LEAST FIVE DAYS IN ADVANCE OF LAYOUT. EIO NOTIFIED ON <u>8/1</u> DCMA NOTIFIED ON <u>8/1</u> APPROVAL RECEIVED ON <u>NA</u>	Q ENG OR QA MGR	Chc
100	INTERIM LAYOUT SOP LAYOUT 0100	INSPECT CASTING TO VERIFY DIMENSIONS. THIS STEP MAY BE DELAYED UNTIL ALL REPAIRS ARE COMPLETE. NOTE: THE FIRST PART PRODUCED OF EACH TYPE A, B AND C WILL BE DIMENSIONED BY LAWTON PATTERN. IF DIMENSIONED BY LAWTON IT WILL BE DOCUMENTED HERE. Subsequent casting done internally per Romer Arm.	Jody	11/8/05
110	INTERIM VISUAL INSPECTION CQP-500 REV 4	VISUALLY INSPECT 100% of COMPONENT ACCORDING TO ASTM A802 LEVEL 3 IN NON MACHINED AREAS AND LEVEL 2 IN MACHINED AREAS. IF OK CHECK HERE _____ IF REJECTED CHECK HERE _____. MARK AND REPAIR AT STEP 120.	VT - LEVEL II	NA
NOTICE	WITNESS NOTIFICATION	PROVIDE NOTICE TO EIO AND DCMA AT LEAST FIVE DAYS IN ADVANCE OF LP STEP. EIO NOTIFIED ON _____ DCMA NOTIFIED ON _____	Q ENG OR QA MGR	↓

Vis +
2PI
delayed
take after
RT
Chc

**Energy Industries of Ohio
Manufacturing and Test Sequence (MTS) Serial Number C-5 Coil**

3 OF 11 **CO# 40851 Dated 3-9-05 Revision: Rev 8 Dated Issued:7-29-05**

115	INTERIM 100% L.P. CQP 0300 REV 10	L.P. 100% OF COMPONENT. ACCEPTANCE PER ASTM A903. ACCEPTANCE CRITERIA- LEVEL 1 FOR HIGH STRESSED AREAS, LEVEL 2 FOR ALL OTHER AREAS. SEE LP DRAWING. IF OK CHECK HERE _____ IF REJECTED CHECK HERE _____ MARK AND REPAIR AT STEP 120.	LP - LEVEL II	NA ↓
120	WELD SOP 0100 REV 7	EXCAVATE ANY DEFECTS FOUND DURING 100% VISUAL AND LP INSPECTION.		
125	GRIND GCHI SOP 0100R2	CHIP AND HAND GRIND EXCAVATION AS REQUIRED.		
130	L.P. EXCAVATION CQP-300 REV 10	L.P. ALL EXCAVATIONS PRIOR TO WELDING TO ENSURE REMOVAL OF DEFECT. ACCEPTANCE PER A903. ACCEPTANCE CRITERIA-LEVEL 1 FOR HIGH STRESSED AREAS, LEVEL 2 FOR ALL OTHER AREAS. SEE LP DRAWING. IF OK CHECK HERE _____ IF REJECTED SEND BACK TO STEP 125.	LP - LEVEL II	
165	SAND BLAST BLAS SOP 0100R6	SANDBLAST (REMOVE ALL BLAST MATERIAL FROM CASTING) SANDBLASTING WILL BE DONE USING RECYCLED SHARP ANGULAR AGGREGATE.		
170	WELD MAP	MAP ALL MAJOR WELDS WITH DIGITAL PHOTO/MAPS INDICATING LOCATION. SERIALIZE DEFECTS ON CASTING, USE SCALE IN PHOTOS AND DOCUMENT SIZE. THIS IS TO BE PERFORMED BY SUPERVISOR, INSPECTION LEAD MAN OR THEIR DESIGNEE, FILE WITH QA. USE YELLOW MARKER. MUST INDICATE ON MAP ALL MAJOR WELDS, DEFINED AS GREATER THAN 20% OF THE WALL OR 1 INCH WHICHEVER IS LESS OR 10 SQUARE INCHES APPROXIMATLY 3.3"X3.3".		
NOTICE	WITNESS NOTIFICATION	PROVIDE NOTICE TO EIO AND DCMA AT LEAST FIVE DAYS IN ADVANCE OF X-RAY AND DIMENSIONAL STEPS. EIO NOTIFIED ON <u>8/23/05</u> DCMA NOTIFIED ON <u>8/23/05</u>	Q ENG OR QA MGR	
190	X-RAY AT MQS MQS PROCEDURE 20.H.010 REV 0	X-RAY PER TECHNIQUE # 12726 USE CALIBRATED DENSITOMETER FOR DENSITY VERIFICATION. WHEN MARKING USE BLACK MARKERS. ATTACH TECHNIQUE, READER SHEET FOR ALL RADIOGRAPHS. MUST INDICATE RADIOGRAPHER AND ASNT CERTIFICATION LEVEL ON READER SHEET.	RT - LEVEL II 8/27/05	RMS
210	X-RAY CQP 401 REV 5	X-RAY INTERPRETATION. ACCEPTANCE MSS SP 54. ATTACH TECHNIQUE, READER SHEET FOR ALL RADIOGRAPHS. MUST INDICATE RADIOGRAPHER AND ASNT CERTIFICATION LEVEL ON READER SHEET. IF OK CHECK HERE _____ AND SEND TO STEP 260. REJECTED CHECK HERE _____ MARK UP DEFECTS AND SEND THE CASTING TO STEP 220.	RT - LEVEL II 9/14 DM	DCMA STAD 9/14/05

**Energy Industries of Ohio
Manufacturing and Test Sequence (MTS) Serial Number C-5 Coil**

4 OF 11 CO# 40851 Dated 3-9-05 Revision: Rev 8 Dated Issued:7-29-05

220	WELD SOP 0100 REV 7	EXCAVATE ANY DEFECTS FOUND DURING RADIOGRAPHY.		
225	GRIND GCHI SOP 0100R2	CHIP AND HAND GRIND EXCAVATION AS REQUIRED.	CA	9/14
230	L.P. EXCAVATION CQP-300 REV 10	L.P. ALL EXCAVATIONS PRIOR TO WELDING TO ENSURE REMOVAL OF DEFECT. ACCEPTANCE PER A903. ACCEPTANCE CRITERIA-LEVEL 1 FOR HIGH STRESSED AREAS, LEVEL 2 FOR ALL OTHER AREAS. SEE LP DRAWING. IF OK CHECK HERE _____ IF REJECTED SEND BACK TO STEP 225.	LP - LEVEL II TRC	9/14/05
240	WELD MAP	MAP ALL WELDS WITH DIGITAL PHOTO/MAPS INDICATING LOCATION. SERIALIZE DEFECTS ON CASTING, USE SCALE IN PHOTOS AND DOCUMENT SIZE. THIS IS TO BE PERFORMED BY SUPERVISOR, INSPECTION LEAD MAN OR THEIR DESIGNEE, FILE WITH QA. USE YELLOW MARKER. MUST INDICATE ON MAP ALL MAJOR WELDS, DEFINED AS GREATER THAN 20% OF THE WALL OR 1 INCH WHICHEVER IS LESS OR 10 SQUARE INCHES APPROXIMATLY 3.3"X3.3".	✓ JR	
NOTICE	WITNESS NOTIFICATION	PROVIDE NOTICE TO EIO AND DCMA AT LEAST FIVE DAYS IN ADVANCE OF WELD STEP. EIO NOTIFIED ON _____ DCMA NOTIFIED ON <u>9/14/05</u>	Q ENG OR QA MGR	RMS
260	QA APPROVAL HOLD POINT	QA TO APPROVE ELECTRODE PRIOR TO USE <u>Level</u> PROCEDURE USED: <u>15GMAW CF8MnNiMo</u> MATERIAL/LOT USED: <u>3018513/78308</u> QUALITY ENG. Name: <u>CA</u> Date: <u>10/6/05</u>		
270	WELD SOP 0100 REV 7	WELD REPAIR DEFECTS AS MARKED. FOR WELDS <2" - WPS 10-SMAW-CF8MNMN MOD REV 1(Flat) or 25 SMAW-CF8MNMN MOD REV 0 (Vertical) FOR WELDS <8" - WPS 15-GMAW-CF8MNMN MOD REV 2	TLs 10/6/05 TAD 10/25/05	
280	GRIND GCHI SOP 0100R2	HAND GRIND WELDS.	DWP KLB 10/19/05	
290	L.P. WELD CQP 0300 REV 10	L.P. WELD REPAIRS ACCEPTANCE PER ASTM A903. ACCEPTANCE CRITERIA-LEVEL 1 FOR HIGH STRESSED AREAS, LEVEL 2 FOR ALL OTHER AREAS. SEE LP DRAWING. IF OK CHECK HERE _____ WASH AND SEND TO STEP 300. IF REJECTED CHECK HERE _____	LP - LEVEL II JR Repair Loop	
	REPEAT	REPEAT STEPS <u>220 TO 290</u> AS REQUIRED TILL CLEAR THROUGH VISUAL INSPECTION & PENETRANT INSPECTION. DOCUMENT REWORK ON STEPS S220 TO S290. IF OK CHECK HERE _____ AND PROCEED TO STEP 295.		
	REPEAT STEPS	SUPPLEMENTAL REPAIR STEPS		
S220	WELD SOP 0100 REV 7	EXCAVATE ANY DEFECTS FOUND DURING RADIOGRAPHY.	RT TS 11-9	1 ST 10/31/05 RKR5 2 ND 11/7 Eg 3 RD 11-8-05 TH Accept 4 TH 5 TH

DCMA
STAMP

**Energy Industries of Ohio
Manufacturing and Test Sequence (MTS) Serial Number C-5 Coil**

5 OF 11 CO# 40851 Dated 3-9-05 Revision: Rev 8 Dated Issued: 7-29-05

NA

S230	L.P. EXCAVATION CQP-300 REV 10	L.P. ALL EXCAVATIONS PRIOR TO WELDING TO ENSURE REMOVAL OF DEFECT. ACCEPTANCE PER A903. ACCEPTANCE CRITERIA-LEVEL 1 FOR HIGH STRESSED AREAS, LEVEL 2 FOR ALL OTHER AREAS. SEE LP DRAWING.	LP - LEVEL II				
S240	WELD MAP	MAP ALL MAJOR WELDS WITH DIGITAL PHOTO/MAPS INDICATING LOCATION. SERIALIZE DEFECTS ON CASTING, USE SCALE IN PHOTOS AND DOCUMENT SIZE. THIS IS TO BE PERFORMED BY SUPERVISOR, INSPECTION LEAD MAN OR THEIR DESIGNEE, FILE WITH QA. USE YELLOW MARKER. MUST INDICATE ON MAP ALL MAJOR WELDS, DEFINED AS GREATER THAN 20% OF THE WALL OR 1 INCH WHICHEVER IS LESS OR 10 SQUARE INCHES APPROXIMATLY 3.3"X3.3".					
NOTICE	WITNESS NOTIFICATION	PROVIDE NOTICE TO EIO AND DCMA AT LEAST FIVE DAYS IN ADVANCE OF WELD STEP. EIO NOTIFIED ON _____ DCMA NOTIFIED ON _____	Q ENG OR QA MGR				
S260	QA APPROVAL HOLD POINT	QA TO APPROVE ELECTRODE PRIOR TO USE. PROCEDURE USED: _____ MATERIAL /LOT USED : _____ QUALITY ENG. Name: _____ Date: _____					
S270	WELD SOP 0100 REV 7	WELD REPAIR DEFECTS AS MARKED. FOR WELDS <2" - WPS 10-SMAW-CF8MNMN MOD REV 1(Flat) or 25 SMAW-CF8MNMN MOD REV 0 (Vertical) FOR WELDS <8" - WPS 15-GMAW-CF8MNMN MOD REV 2					
S280	GRIND GCHI SOP 0100R2	HAND GRIND WELDS.					
S290	L.P. WELD CQP 0300 REV 10	L.P. WELD REPAIRS ACCEPTANCE PER ASTM A903. ACCEPTANCE CRITERIA-LEVEL 1 FOR HIGH STRESSED AREAS, LEVEL 2 FOR ALL OTHER AREAS. SEE LP DRAWING. IF OK CHECK HERE _____ WASH AND SEND TO STEP 300. IF REJECTED CHECK HERE _____ AND RETURN TO STEP S220.	LP - LEVEL II <i>WP</i>	<i>11/8</i> REJ	<i>11/10</i> REJ	OK REJ	OK REJ
	REPEAT	REPEAT STEPS S220 TO S290 AS REQUIRED TILL CLEAR THROUGH VISUAL INSPECTION & PENETRANT INSPECTION.	QA ENG.				
295	TEST MAG PERM SOP MAG PERM 100, REV 1	TEST MAG PERMEABILITY REPAIR AREAS TEST AT LEAST 5 POINTS PER WELD. ACCEPTANCE 1.02. IF OK CHECK HERE _____ AND GO TO STEP 300. IF REJECTED CHECK HERE _____.		<i>OK</i>	<i>11/8</i> <i>11/10</i>		
296	GRIND GCHI SOP 0100R2	GRIND AREAS OF NON COMPLIANCE AND RETURN TO STEP 295. REPEAT UNTIL COMPLIANCE IS ACHIEVED.			<i>NA</i>		
300	X-RAY (NOTE)	IF RADIO GRAPHED AREAS ARE GREATER THAN FOUR TO FIVE INCHES THE CASTING WILL BE SENT TO MQS. SEND TO MQS CHECK HERE _____ RADIOGRAPH AT CAF CHECK HERE <input checked="" type="checkbox"/>	QA ENGINE ER			<i>27 clw</i> <i>AT CAF</i> <i>clw</i>	

**Energy Industries of Ohio
Manufacturing and Test Sequence (MTS) Serial Number C-5 Coil**

6 OF 11 CO# 40851 Dated 3-9-05 Revision: Rev 8 Dated Issued:7-29-05

310 A	MQS X-RAY DEFECTS REPAIRED BY WELDING	X-RAY PER TECHNIQUE # 12726 USE CALIBRATED DENSITOMETER FOR DENSITY VERIFICATION. ATTACH TECHNIQUE, READER SHEET FOR ALL RADIOGRAPHS. MUST INDICATE RADIOGRAPHER AND ASNT CERTIFICATION LEVEL ON READER SHEET.	LEVEL II					
310 B	CAF X-RAY DEFECTS REPAIRED BY WELDING CQP 401 REV 5	X-RAY PER TECHNIQUE # 12726 USE CALIBRATED DENSITOMETER FOR DENSITY VERIFICATION. ATTACH TECHNIQUE, READER SHEET FOR ALL RADIOGRAPHS. MUST INDICATE RADIOGRAPHER AND ASNT CERTIFICATION LEVEL ON READER SHEET.	RT - LEVEL II					
320	X-RAY CQP 401 REV 5	X-RAY INTERPRETATION. ACCEPTANCE MSS SP 54. ATTACH TECHNIQUE, READER SHEET FOR ALL RADIOGRAPHS. MUST INDICATE RADIOGRAPHER AND ASNT CERTIFICATION LEVEL ON READER SHEET. IF OK CHECK HERE _____ AND SEND TO STEP 340. REJECTED CHECK HERE _____ MARK UP DEFECTS AND SEND THE CASTING TO STEP 220.	RT - LEVEL II					su 5220
	REPEAT STEPS	SUPPLEMENTAL REPAIR STEPS	1 ST	2 ND	3 RD	4 TH	5 TH	
S321	WELD SOP 0100 REV 7	EXCAVATE ANY DEFECTS FOUND DURING RADIOGRAPHY.	NA					
S322	L.P. EXCAVATION CQP-300 REV 10	L.P. ALL EXCAVATIONS PRIOR TO WELDING TO ENSURE REMOVAL OF DEFECT. ACCEPTANCE PER A903. ACCEPTANCE CRITERIA-LEVEL 1 FOR HIGH STRESSED AREAS, LEVEL 2 FOR ALL OTHER AREAS. SEE LP DRAWING.	LP - LEVEL II					
S323	WELD MAP	MAP ALL MAJOR WELDS WITH DIGITAL PHOTO/MAPS INDICATING LOCATION. SERIALIZE DEFECTS ON CASTING, USE SCALE IN PHOTOS AND DOCUMENT SIZE. THIS IS TO BE PERFORMED BY SUPERVISOR, INSPECTION LEAD MAN OR THEIR DESIGNEE, FILE WITH QA. USE YELLOW MARKER. MUST INDICATE ON MAP ALL MAJOR WELDS, DEFINED AS GREATER THAN 20% OF THE WALL OR 1 INCH WHICHEVER IS LESS OR 10 SQUARE INCHES APPROXIMATLY 3.3"X3.3".						
NOTICE	WITNESS NOTIFICATION	PROVIDE NOTICE TO EIO AND DCMA AT LEAST FIVE DAYS IN ADVANCE OF WELD STEP. EIO NOTIFIED ON _____ DCMA NOTIFIED ON _____	Q ENG OR QA MGR					
S324	QA APPROVAL HOLD POINT	QA TO APPROVE ELECTRODE PRIOR TO USE. PROCEDURE USED: _____ MATERIAL /LOT USED : _____ QUALITY ENG. Name: _____ Date: _____						
S325	WELD SOP 0100 REV 7	WELD REPAIR DEFECTS AS MARKED. FOR WELDS <2" - WPS 10-SMAW-CF8MNMN MOD REV 1(Flat) or 25 SMAW-						

**Energy Industries of Ohio
Manufacturing and Test Sequence (MTS) Serial Number C-5 Coil**

7 OF 11 CO# 40851 Dated 3-9-05 Revision: Rev 8 Dated Issued:7-29-05

		CF8MNMN MOD REV 0 (Vertical) FOR WELDS <8" - WPS 15-GMAW-CF8MNMN MOD REV 2					
S326	GRIND GCHI SOP 0100R2	HAND GRIND WELDS.	<i>Grind</i>	<i>JR</i>	<i>11/16</i>		
S327	L.P. WELD CQP 0300 REV 10	L.P. WELD REPAIRS ACCEPTANCE PER ASTM A903. ACCEPTANCE CRITERIA-LEVEL 1 FOR HIGH STRESSED AREAS, LEVEL 2 FOR ALL OTHER AREAS. SEE LP DRAWING. IF OK CHECK HERE _____ WASH AND SEND TO STEP 300. IF REJECTED CHECK HERE _____ AND RETURN TO STEP S321.	LP - LEVEL II <i>JR</i>	<i>OK</i>	OK	OK	OK
	REPEAT	REPEAT STEPS S321 TO S327 AS REQUIRED TILL CLEAR THROUGH VISUAL INSPECTION & PENETRANT INSPECTION.	QA ENG.	<i>OK</i>	<i>chr</i>		
340	SAND BLAST BLAS SOP 0100R6	SANDBLAST (REMOVE ALL BLAST MATERIAL FROM CASTING) SANDBLASTING WILL BE DONE USING RECYCLED SHARP ANGULAR AGGREGATE.			<i>BB</i>	<i>11/16</i>	
NOTICE	WITNESS NOTIFICATION	PROVIDE NOTICE TO EIO AND DCMA AT LEAST FIVE DAYS IN ADVANCE OF VISUAL AND LP STEPS. EIO NOTIFIED ON <i>11/7</i> DCMA NOTIFIED ON <i>11/7</i>			Q ENG OR QA MGR	<i>chr</i>	
350	FINAL VISUAL INSPECTION CQP-500 REV 4	VISUALLY INSPECT 100% of COMPONENT ACCORDING TO ASTM A802 LEVEL 3 IN NON MACHINED AREAS AND LEVEL 2 IN MACHINED AREAS. IF OK CHECK HERE <input checked="" type="checkbox"/> IF REJECTED CHECK HERE _____. MARK AND REPAIR AT STEP 385. MUST BE PERFORMED BY LEVEL II in VT.			VT - LEVEL II <i>JDR</i>	<i>11/16</i>	
360	FINAL L.P. CQP 0300 REV 10	FINAL L.P. 100% OF COMPONENT. ACCEPTANCE PER ASTM A903. ACCEPTANCE CRITERIA-LEVEL 1 FOR HIGH STRESSED AREAS, LEVEL 2 FOR ALL OTHER AREAS. SEE LP DRAWING. IF OK CHECK HERE _____ WASH AND SEND TO STEP 455. IF REJECTED CHECK HERE _____			LP - LEVEL II <i>JDR</i>	<i>11/16</i>	
380	WELD SOP 0100 REV 7	EXCAVATE ANY DEFECTS FOUND DURING FINAL PENETRANT INSPECTION.					
385	GRIND GCHI SOP 0100R2	CHIP AND HAD GRIND EXCAVATION AS REQUIRED.					
390	L.P. EXCAVATION CQP-300 REV 10	L.P. ALL EXCAVATIONS PRIOR TO WELDING TO ENSURE REMOVAL OF DEFECT. ACCEPTANCE PER A903. IF OK CHECK HERE _____ IF REJECTED SEND BACK TO STEP 385.			LP - LEVEL II		

NA

**Energy Industries of Ohio
Manufacturing and Test Sequence (MTS) Serial Number C-5 Coil**

8 OF 11 CO# 40851 Dated 3-9-05 Revision: Rev 8 Dated Issued:7-29-05

N4

400	WELD MAP	MAP ALL MAJOR WELDS WITH DIGITAL PHOTO/MAPS INDICATING LOCATION. SERIALIZE DEFECTS ON CASTING, USE SCALE IN PHOTOS AND DOCUMENT SIZE. THIS IS TO BE PERFORMED BY SUPERVISOR, INSPECTION LEAD MAN OR THEIR DESIGNEE, FILE WITH QA. USE YELLOW MARKER. MUST INDICATE ON MAP ALL MAJOR WELDS, DEFINED AS GREATER THAN 20% OF THE WALL OR 1 INCH WHICHEVER IS LESS OR 10 SQUARE INCHES APPROXIMATLY 3.3"X3.3".		
420	QA APPROVAL HOLD POINT	QA TO APPROVE ELECTRODE PRIOR TO USE. PROCEDURE USED: _____ MATERIAL/LOT USED: _____ QUALITY ENG. Name: _____ Date: _____		
430	WELD SOP 0100 REV 7	WELD REPAIR DEFECTS AS MARKED. FOR WELDS <2" - WPS 10-SMAW-CF8MNMN MOD REV 1(Flat) or 25 SMAW-CF8MNMN MOD REV 0 (Vertical) FOR WELDS <8" - WPS 15-GMAW-CF8MNMN MOD REV 2		
440	GRIND GCHI SOP 0100 REV 2	HAND GRIND WELDS.		
450	L.P. WELDS CQP 0300 REV 10	L.P. WELD REPAIRS ACCEPTANCE PER ASTM A903. IF OK CHECK HERE _____ WASH AND SEND TO STEP 460. IF REJECTED CHECK HERE _____ AND RETURN TO STEP 440.	LP - LEVEL II	
	REPEAT	REPEAT STEPS 350 TO 450 AS REQUIRED TILL WELDS CLEAR FINAL LIQUID PENETRANT INSPECTION. DOCUMENT REWORK ON A SUPPLEMENTAL MTS	QA ENG.	
451	TEST MAG PERM SOP MAG PERM 100, REV 1	TEST MAG PERMEABILITY REPAIR AREAS. RECORD ON WELD MAP LIST. TEST AT LEAST 5 POINTS PER WELD. ACCEPTANCE 1.02. IF OK CHECK HERE _____ AND GO TO STEP 430. IF REJECTED CHECK HERE _____.		
452	GRIND GCHI SOP 0100R2	GRIND AREAS OF NON COMPLIANCE AND RETURN TO STEP 451. REPEAT UNTIL COMPLIANCE IS ACHIEVED.		
455	HEAT TREAT	STRESS RELIEF. Load casting into cold furnace. Ramp up to 1100 F at rate of 200 F per hour. Hold at temp 4 hours. Furnace cool to 500 F at 50 F per hour. Air cool. Submit furnace charts to QA.	KMR	11/14/05
NOTICE	WITNESS NOTIFICATION	PROVIDE NOTICE TO EIO AND DCMA AT LEAST FIVE DAYS IN ADVANCE OF VISUAL AND LP STEPS. EIO NOTIFIED ON 11/7 DCMA NOTIFIED ON 11/7	Q ENG OR QA MGR	Ctr

↓

This is a replacement MTS. Original was stamped and can't be copied

460	FINAL VISUAL INSPECTION CQP-500 REV 4	VISUALLY INSPECT 100% of COMPONENT ACCORDING TO ASTM A802 LEVEL 3 ALL CONDITIONS. IF OK CHECK HERE _____ IF REJECTED CHECK HERE <u>✓</u> . MARK AND REPAIR AT STEP 390. MUST BE PERFORMED BY LEVEL II in VT.	VT - LEVEL II JDR	11/15	DCMA stamp
470	FINAL L.P. CQP 0300 REV 10	FINAL L.P. 100% OF COMPONENT. ACCEPTANCE PER ASTM A903. ACCEPTANCE CRITERIA-LEVEL 1 FOR HIGH STRESSED AREAS, LEVEL 2 FOR ALL OTHER AREAS. SEE LP DRAWING. IF OK CHECK HERE _____ WASH AND SEND TO STEP 455. IF REJECTED CHECK HERE <u>✓</u> . DOCUMENT REPAIRS USING S321 THROUGH S327.	LP - LEVEL II JDR	11/15	DCMA stamp
NOTICE	WITNESS NOTIFICATION	PROVIDE NOTICE TO EIO AND DCMA AT LEAST FIVE DAYS IN ADVANCE OF MAG PERM STEPS. EIO NOTIFIED ON <u>11/7</u> DCMA NOTIFIED ON <u>11/7</u>	Q ENG OR QA MGR		Ctr
500	FINAL MAG PERM INSPECTION SOP MAG PERM 100, REV 1	PERFORM MAG PERM TESTING WITH SEVRIN GAUGE. ACCEPTANCE 1.02. CHECK THE ENTIRE SURFACE ON A 6"BY6" GRID. REPORT RESULTS. USE A 6" SQUARE BLOCK TO INDICATE TEST LOCATIONS AND RECORD RESULTS. COMPLIANT AREAS WILL NOT BE MARKED. MARK NONCOMPLIANT AREAS WITH AN "X" FOR REPAIR. OK CHECK HERE _____ AND GO TO STEP 530. IF REJECTED CHECK HERE _____	TRC	11/17/05	
510	GRIND GCHI SOP 0100 REV 2	HAND GRIND WITH SUITABLE CONE OR OTHER SIMILAR GRINDER AS REQUIRED TO ENSURE REMOVAL OF MATERIAL TO ACHIEVE MAG PERM REQUIREMENT. CIRCLE AREA REMEDIATE FOR RETEST.			
520	RETEST MAG PERM SOP MAG PERM 100, REV 1	RETEST MAG PERMEABILITY AT FAILED TEST POINTS. MARK NONCOMPLIANT AREAS WITH AN "X" FOR REPAIR. ACCEPTANCE 1.02. IF OK CHECK HERE _____ . IF REJECTED CHECK HERE _____ RETURN TO STEP 510.			
530	DOC. REVIEW	REVIEW DOCUMENTS AS REQUIRED IN CAF CHECKLIST, ALL DOCUMENTS NOTED TO BE ACCESSIBLE FOR AUDITING. (SHIPPER, C OF C, M.T.R., M.T.S., INSPECTION REPORT, X-RAY READER SHEETS AND HEAT TREAT CHARTS)			
NOTICE	RELEASE FROM EIO	PROVIDE DOCUMENTS TO EIO. SENT ON <u>11/21</u> BY <u>Ctr</u> . RECEIVED RELEASE FROM EIO ON _____.	Q ENG OR QA MGR		Ctr
540	PACK AND SHIP	PACKAGE AND SHIP TO MAJOR TOOL.			
1000	REVISION HISTORY	ORIGINAL 12-14-04. Approved 12-14-04. Revision level 1- Revised 1-26-05 new page 8, correct High stress areas, Revision level 2 3-16-05, delete LO step 455. Revision 3 3-28-05 Added note regarding hold point at weld step 400. Revision level 4 written for C-2 casting 4-18-05. Rev 5 added Layout SOP# and note regarding first casting layout responsibility. 5-10-05. Rev 6 added word LOT to weld material steps. 5-29-05. Rev 7 6-14-05 added "LOT" to weld step on supplement page. Rev. 8 7-29-05 added stress relief , deleted weld hold points, added vertical weld procedure, and several editorial changes.	CARUUD		

original on file at CAF. Ctr



GENERAL ISOMETRIC
VIEW FROM TOP SIDE

**TABS DESIGNATE
CRITICAL AREA**

RED AREA INDICATES HIGH STRESSED AREA

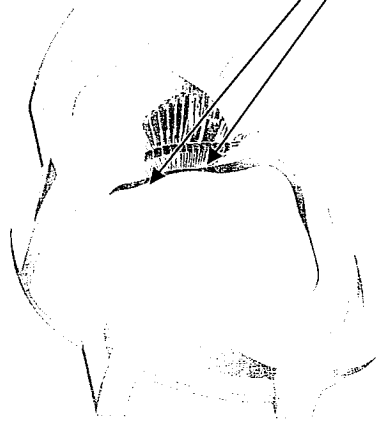

TOP SIDE ISOMETRIC

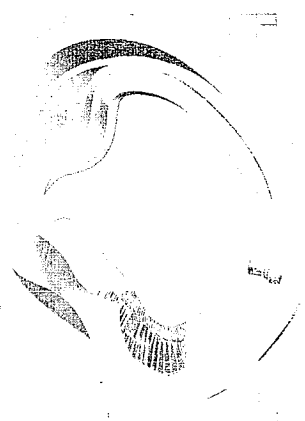

TOP SIDE VIEW

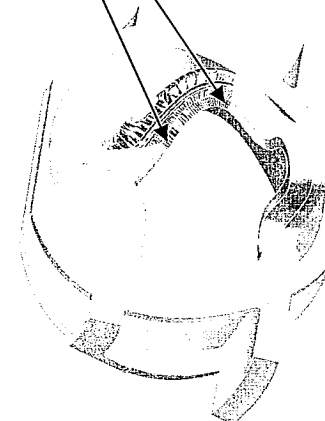

BOTTOM SIDE ISOMETRIC

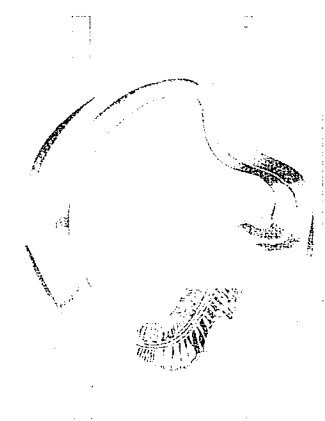

BOTTOM SIDE VIEW

Energy Industries of Ohio

Manufacturing and Test Sequence (MTS) Serial Number C-5 Coil

11 OF 11 CO# 40851 Dated 3-9-05 Revision: Rev 8 Dated Issued:7-29-05

Energy Industries of Ohio

Manufacturing and Test Sequence (MTS) Coill C Shim

FIVE PARTS KEEP TOGETHER

CO# 40851, Pattern SE 141-073 -5 MS73220-2 Dated December 14, 2004 Revision: Original

Page 1 of 6

Dated Issued: 4-27-05

OPER. #	STATION	DESCRIPTION OF PROCESS	Name	Date
		Keep all parts together. Sign and date each step when all 5 parts have been completed.		
10	QUALITY RELEASE	REVIEW AND APPROVE MTS. RECEIVED APPROVAL FROM EIO ON <u>Pete</u> FROM <u>12/15</u>	<u>CR</u>	<u>4/21/05</u>
20	PATTERN NPAT SOP 0100REV2	APPLY APPROPRIATE PART NUMBER, SERIAL NUMBER, FOUNDRY MARK, TO THE PATTERN.	<u>TB</u>	<u>4/22/05</u>
30	MOLD MOLD SOP 0400 REV 8 CALIBRATION PER MOLD SOP 0900 REV 5 PREPARATION PER MOLD SOP 1100R2/1200R2/1300R1 SAND TESTING PER MOLD SOP 1400R2/1500R3/1600R2	MOLD PER WORK INSTRUCTIONS IN MAPICS ROUTING AND SOPS REFERENCED. ENGINEER OF RECORD - ROGER BROMAN, CONSULT ON MOLD-RELATED CONCERNS. MOLD MATERIALS REQUIRED PER MAPICS BOM. NOTIFY ENGINEER OF ANY SUBSTITUTIONS.	<u>CR</u>	<u>4/22</u>
40	POUR MELT SOP 0100R5 MELT SOP 0700R2 MELT SOP 0600R2	METAL MUST BE AOD REFINED OR AOD INGOT. VIRGIN METAL ADDITIONS ALLOWED. RECORD POURING TEMPERATURE: <u>2825</u> CASTING POURED AT: <u>1245pm</u> DATE: <u>4/28</u> HEAT #'s: <u>29198</u> ELAPSED POUR TIME <u>WA</u> KEEL BLOCKS POURED: <u>YES</u> Sample from ladle to be analyzed for final chemical analysis and reported on material certifications. Sample Taken by: <u>SR</u> Analyzed: <u>GH</u> Date: <u>4/28</u> Note: Make 15 additional test bars for mechanical testing.	<u>JG</u>	<u>4/28/05</u>
50	MELT SOP 0800R2	SHAKEOUT	<u>CA</u>	<u>4/29/05</u>
60	ARC RISE SOP 0100R1	REMOVE RISERS AS DIRECTED BY SUPERVISOR.	<u>BNVH</u>	<u>6/16/05</u>
70	HEAT TREAT HEAT SOP 0103R5	SOLUTION ANNEAL. With C-1 Coil.	<u>DLS</u>	<u>6/2/05</u>

Energy Industries of Ohio

Manufacturing and Test Sequence (MTS) Coill C Shim

FIVE PARTS KEEP TOGETHER

CO# 40851, Pattern SE 141-073 -5 MS73220-2 Dated December 14, 2004 Revision:Original

Page 2 of 6

Dated Issued:4-27-05

80	PHYSICAL TESTING	OBTAIN TEST SPECIMENS AND SUBMIT FOR PHYSICAL TESTING. REPORT RESULTS AS PART OF STEP 480.	NA	
90	GRIND GSWA SOP 0100R3 GCHI SOP 0100R2	SWING GRIND TO REMOVE RISER REMAINS AND FLASH IF REQUIRED. CHIP AND HAD GRIND SURFACE OF PART AS REQUIRED.	CEG * 6-16-05	
100	SAND BLAST BLAS SOP 0100R6	SANDBLAST (REMOVE ALL BLAST MATERIAL FROM CASTING) SANDBLASTING WILL BE DONE USING RECYCLED SHARP ANGULAR AGGREGATE.	CAZ	4/17
110	VISUAL INSPECTION CQP-500 REV 4	VISUALLY INSPECT 100% of COMPONENT ACCORDING TO ASTM A802 LEVEL 3 ALL CONDITIONS. IF OK CHECK HERE _____. IF REJECTED CHECK HERE _____. MARK AND REPAIR AT STEP 130.	VT - LEVEL II	see # 322
NOTICE	WITNESS NOTIFICATION	PROVIDE NOTICE TO EIO AND DCMA AT LEAST FIVE DAYS IN ADVANCE OF LP STEP. EIO NOTIFIED ON <u>11/1</u> DCMA NOTIFIED ON <u>11/1</u>	Q ENG OR QA MGR	CAZ
120	100% L.P. CQP 0300 REV 10	L.P. 100% OF COMPONENT. ACCEPTANCE PER ASTM A903. ACCEPTANCE CRITERIA- LEVEL 2. IF OK CHECK HERE _____. IF REJECTED CHECK HERE _____. MARK AND REPAIR AT STEP 120.	LP - LEVEL II	NA
130	WELD SOP 0100 REV 7	EXCAVATE ANY DEFECTS FOUND DURING 100% VISUAL AND LP INSPECTION.		
140	L.P. EXCAVATION CQP-300 REV 10	L.P. ALL EXCAVATIONS PRIOR TO WELDING TO ENSURE REMOVAL OF DEFECT. ACCEPTANCE PER A903. ACCEPTANCE CRITERIA- LEVEL 2.	LP - LEVEL II	
150	SAND BLAST BLAS SOP 0100R6	SANDBLAST (REMOVE ALL BLAST MATERIAL FROM CASTING) SANDBLASTING WILL BE DONE USING RECYCLED SHARP ANGULAR AGGREGATE.		
160	WELD MAP	MAP ALL WELDS WITH DIGITAL PHOTO/MAPS. SERIALIZE DEFECTS ON CASTING, USE SCALE IN PHOTOS AND DOCUMENT SIZE. THIS IS TO BE PERFORMED BY SUPERVISOR, INSPECTION LEAD MAN OR THEIR DESIGNEE, FILE WITH QA.. USE YELLOW MARKER. MUST SEND REPORT ON ALL WELDS OVER 10% OF NOMINAL WALL THICKNESS TO CUSTOMER. DEFECTS > 10% YES _____, REPORT SENT BY _____ DATE _____ DEFECTS < 10 % _____ SIGN BY QA ENG.		
NOTICE	WITNESS NOTIFICATION	PROVIDE NOTICE TO EIO AND DCMA AT LEAST FIVE DAYS IN ADVANCE OF XRAY AND LAYOUT STEPS. EIO NOTIFIED ON <u>11/1</u> DCMA NOTIFIED ON <u>11/1</u>	Q ENG OR QA MGR	CAZ

Energy Industries of Ohio

FIVE PARTS KEEP TOGETHER

Manufacturing and Test Sequence (MTS) Coill C Shim

CO# 40851, Pattern SE 141-073 -5 MS73220-2 Dated December 14, 2004 Revision:Original

Page 3 of 6

Dated Issued:4-27-05

170	CAF X-RAY CQP 401 REV 5	X-RAY PER TECHNIQUE: To be determined. USE CALIBRATED DENSITOMETER FOR DENSITY VERIFICATION. ATTACH TECHNIQUE, READER SHEET FOR ALL RADIOGRAPHS. MUST INDICATE RADIOGRAPHER AND ASNT CERTIFICATION LEVEL ON READER SHEET.	RT - LEVEL II RBK	11-8-05
180	X-RAY CQP 401 REV 5	X-RAY INTERPRETATION. ACCEPTANCE MSS SP 54. ATTACH TECHNIQUE, READER SHEET FOR ALL RADIOGRAPHS. MUST INDICATE RADIOGRAPHER AND ASNT CERTIFICATION LEVEL ON READER SHEET. IF OK CHECK HERE <input checked="" type="checkbox"/> AND SEND TO STEP 310. REJECTED CHECK HERE <input type="checkbox"/> MARK UP DEFECTS AND SEND THE CASTING TO STEP 200..	RT - LEVEL II RBK	11-8-05
190	LAYOUT	INSPECT CASTING TO VERIFY DIMENSIONS. THIS MAY BE PERFORMED BEFORE OR AFTER STEP 180. DIMENSIONED <u>Done J</u> DATE <u>9-10-05</u> RELEASED _____ (ENGINEER ONLY)	JJ	9-12-05
200	WELD SOP 0100 REV 7	EXCAVATE ANY DEFECTS FOUND DURING RADIOGRAPHY.		
210	L.P. EXCAVATION CQP-300 REV 10	L.P. ALL EXCAVATIONS PRIOR TO WELDING TO ENSURE REMOVAL OF DEFECT. ACCEPTANCE PER A903. ACCEPTANCE CRITERIA- LEVEL 2.	LP - LEVEL II JPS	11-15-05
220	WELD MAP	MAP ALL WELDS WITH DIGITAL PHOTO/MAPS. SERIALIZE DEFECTS ON CASTING, USE SCALE IN PHOTOS AND DOCUMENT SIZE. THIS IS TO BE PERFORMED BY SUPERVISOR, INSPECTION LEAD MAN OR THEIR DESIGNEE, FILE WITH QA.. MUST SEND REPORT ON ALL WELDS OVER 10% OF NOMINAL WALL THICKNESS TO CUSTOMER. DEFECTS>10% YES _____, REPORT SENT BY _____ DATE _____ DEFECTS < 10 % _____ SIGN BY QA ENG.	NA	See Final on #330
NOTICE	WITNESS NOTIFICATION	PROVIDE NOTICE TO EIO AND DCMA AT LEAST FIVE DAYS IN ADVANCE OF WELD STEP. EIO NOTIFIED ON _____ DCMA NOTIFIED ON _____	Q ENG OR QA MGR	
230	QA APPROVAL HOLD POINT	QA TO APPROVE ELECTRODE PRIOR TO USE. PROCEDURE USED: _____ MATERIAL USED: _____ QUALITY ENG. Name: _____ Date: _____		
240	WELD SOP 0100 REV 7	WELD REPAIR DEFECTS AS MARKED. FOR WELDS <2" - WPS 10-SMAW-CF8MNMN MOD REV 1 FOR WELDS <8" - WPS 15-GMAW-CF8MNMN MOD REV 2		
250	GRIND GCHI SOP 0100R2	HAND GRIND WELDS.		↓

Energy Industries of Ohio

Manufacturing and Test Sequence (MTS) Coill C Shim

FIVE PARTS KEEP TOGETHER

CO# 40851, Pattern SE 141-073 -5 MS73220-2 Dated December 14, 2004 Revision:Original

Page 4 of 6

Dated Issued:4-27-05

260	L.P. WELD CQP 0300 REV 10	L.P. WELD REPAIRS ACCEPTANCE PER ASTM A903. ACCEPTANCE CRITERIA-LEVEL 2. IF OK CHECK HERE _____ WASH AND SEND TO STEP 300. IF REJECTED CHECK HERE _____ AND RETURN TO STEP 220.	LP - LEVEL II	NA
	REPEAT	REPEAT STEPS 220 TO 260 AS REQUIRED TILL CLEAR THROUGH VISUAL INSPECTION & PENETRANT INSPECTION. DOCUMENT REWORK ON A SUPPLEMENTAL MTS	QA ENG.	
270	TEST MAG PERM SOP MAG PERM 100, REV 1	TEST MAG PERMEABILITY REPAIR AREAS RECORD ON WELD MAP LIST. TEST AT LEAST 5 POINTS PER WELD. ACCEPTANCE 1.02. IF OK CHECK HERE _____ AND GO TO STEP 290. IF REJECTED CHECK HERE _____.		
280	GRIND GCHI SOP 0100R2	GRIND AREAS OF NON COMPLIANCE AND RETURN TO STEP 270. REPEAT UNTILL COMPLIANCE IS ACHIEVED.		
290	CAF X-RAY DEFECTS REPAIRED BY WELDING CQP 401 REV 5	X-RAY PER TECHNIQUE: To be determined. USE CALIBRATED DENSITOMETER FOR DENSITY VERIFICATION. ATTACH TECHNIQUE, READER SHEET FOR ALL RADIOGRAPHS. MUST INDICATE RADIOGRAPHER AND ASNT CERTIFICATION LEVEL ON READER SHEET.	RT - LEVEL II	
300	X-RAY CQP 401 REV 5	X-RAY INTERPRETATION. ACCEPTANCE MSS SP 54. ATTACH TECHNIQUE, READER SHEET FOR ALL RADIOGRAPHS. MUST INDICATE RADIOGRAPHER AND ASNT CERTIFICATION LEVEL ON READER SHEET. IF OK CHECK HERE _____ AND SEND TO STEP 310. REJECTED CHECK HERE _____ MARK UP DEFECTS AND SEND THE CASTING TO STEP 200.	RT - LEVEL II	
	REPEAT	REPEAT STEPS 200 TO 300 AS REQUIRED TILL WELDS CLEAR X-RAY. DOCUMENT REWORK ON A SUPPLEMENTAL MTS	QA ENG.	
310	SAND BLAST BLAS SOP 0100R6	SANDBLAST (REMOVE ALL BLAST MATERIAL FROM CASTING) SANDBLASTING WILL BE DONE USING RECYCLED SHARP ANGULAR AGGREGATE.		
NOTICE	WITNESS NOTIFICATION	PROVIDE NOTICE TO EIO AND DCMA AT LEAST FIVE DAYS IN ADVANCE OF VISUAL AND LP STEPS. EIO NOTIFIED ON <u>11/7</u> DCMA NOTIFIED ON <u>11/7</u>	Q ENG OR QA MGR	ctz
320	FINAL VISUAL INSPECTION CQP-500 REV 4	VISUALLY INSPECT 100% of COMPONENT ACCORDING TO ASTM A802 LEVEL 2 ALL CONDITIONS. IF OK CHECK HERE <input checked="" type="checkbox"/> . IF REJECTED CHECK HERE _____ . MARK AND REPAIR AT STEP 340.	VT - LEVEL II JR	11/15/05

Energy Industries of Ohio

Manufacturing and Test Sequence (MTS) Coill C Shim

FIVE PARTS KEEP TOGETHER

CO# 40851, Pattern SE 141-073 -5 MS73220-2 Dated December 14, 2004 Revision:Original

Page 5 of 6

Dated Issued:4-27-05

		MUST BE PERFORMED BY LEVEL II in VT.		
330	FINAL L.P. CQP 0300 REV 10	FINAL L.P. 100% OF COMPONENT. ACCEPTANCE PER ASTM A903. ACCEPTANCE CRITERIA- LEVEL 1 FOR HIGH STRESSED AREAS, LEVEL 2 FOR ALL OTHER AREAS. SEE LP DRAWING. IF OK CHECK HERE <input checked="" type="checkbox"/> WASH AND SEND TO STEP 410. IF REJECTED CHECK HERE <input type="checkbox"/>	LP - LEVEL II	JPS 11/05/05
340	WELD SOP 0100 REV 7	EXCAVATE ANY DEFECTS FOUND DURING FINAL PENETRANT INSPECTION.	NA	
350	L.P. EXCAVATION CQP-300 REV 10	L.P. ALL EXCAVATIONS PRIOR TO WELDING TO ENSURE REMOVAL OF DEFECT. ACCEPTANCE PER A903.	LP - LEVEL II	
370	WELD MAP	MAP ALL WELDS WITH DIGITAL PHOTO/MAPS. SERIALIZE DEFECTS ON CASTING, USE SCALE IN PHOTOS AND DOCUMENT SIZE. THIS IS TO BE PERFORMED BY SUPERVISOR, INSPECTION LEAD MAN OR THEIR DESIGNEE. FILE WITH QA. MUST SEND REPORT ON ALL WELDS OVER 10% OF NOMINAL WALL THICKNESS TO CUSTOMER. NOMINAL WALL THICKNESS TO CUSTOMER. DEFECTS >10% YES _____, REPORT SENT BY _____ DATE _____ DEFECTS < 10 % _____ SIGN BY QA ENG.		
380	WELD SOP 0100 REV 7	WELD REPAIR DEFECTS AS MARKED. FOR WELDS <2" - WPS 10-SMAW-CF8MNMN MOD REV 1 FOR WELDS <8" - WPS 15-GMAW-CF8MNMN MOD REV 2		
390	GRIND GCHI SOP 0100 REV 2	HAND GRIND WELDS.		
400	L.P. WELDS CQP 0300 REV 10	L.P. WELD REPAIRS ACCEPTANCE PER ASTM A903. IF OK CHECK HERE _____ WASH AND SEND TO STEP 460. IF REJECTED CHECK HERE _____ AND RETURN TO STEP 390.	LP - LEVEL II	
	REPEAT	REPEAT STEPS 390 TO 410 AS REQUIRED TILL WELDS CLEAR FINAL LIQUID PENETRANT INSPECTION. DOCUMENT REWORK ON A SUPPLEMENTAL MTS	QA ENG.	
410	TEST MAG PERM SOP MAG PERM 100, REV 1	TEST MAG PERMEABILITY REPAIR AREAS. RECORD ON WELD MAP LIST. TEST AT LEAST 5 POINTS PER WELD. ACCEPTANCE 1.02. IF OK CHECK HERE _____ AND GO TO STEP 430.		

Energy Industries of Ohio

FIVE PARTS KEEP TOGETHER

Manufacturing and Test Sequence (MTS) Coill C Shim

CO# 40851, Pattern SE 141-073 -5 MS73220-2 Dated December 14, 2004 Revision:Original

Page 6 of 6

Dated Issued:4-27-05

420	GRIND GCHI SOP 0100R2	GRIND AREAS OF NON COMPLIANCE AND RETURN TO STEP 420. REPEAT UNTILL COMPLIANCE IS ACHIEVED.	NA ↓	
NOTICE	WITNESS NOTIFICATION	PROVIDE NOTICE TO EIOAND DCMA AT LEAST FIVE DAYS IN ADVANCE OF MAG PERM STEP. EIO NOTIFIED ON <u>11/1</u> DCMA NOTIFIED ON <u>11/1</u>	Q ENG OR QA MGR	<i>CAZ</i>
430	FINAL MAG PERM INSPECTION SOP MAG PERM 100, REV 1	PERFORM MAG PERM TESTING WITH SEVRIN GAUGE. ACCEPTANCE 1.02. CHECK THE ENTIRE SURFACE ON A 6"BY6" GRID. REPORT RESULTS. USE A 6" SQUARE BLOCK TO INDICATE TEST LOCATIONS AND RECORD RESULTS. COMPLIANT AREAS WILL NOT BE MARKED. MARK NONCOMPLIANT AREAS WITH AN "X" FOR REPAIR. OK CHECK HERE <input checked="" type="checkbox"/> AND GO TO STEP 470. IF REJECTED CHECK HERE	RG	11/16
440	GRIND GCHI SOP 0100 REV 2	HAND GRIND WITH SUITABLE CONE OR OTHER SIMILAR GRINDER AS REQUIRED TO ENSURE REMOVAL OF MATERIAL TO ACHIEVE MAG PERM REQUIREMENT. CIRCLE AREA REMEDIATE FOR RETEST.	NA	
450	RETEST MAG PERM SOP MAG PERM 100, REV 1	RETEST MAG PERMEABILITY AT FAILED TEST POINTS. MARK NONCOMPLIANT AREAS WITH AN "X" FOR REPAIR. ACCEPTANCE 1.02. IF OK CHECK HERE . IF REJECTED CHECK HERE RETURN TO STEP 450		
460	PHOTOGRAPH	TAKE DIGITAL PICTURES.		
470	AUDIT REVIEW	PROCESS DOCUMENT TO PROGRAM MANAGER FOR COMPLIANCE AUDIT.	<i>CAZ</i>	11/17/05
480	DOC. REVIEW	REVIEW DOCUMENTS AS REQUIRED IN CAF CHECKLIST, ALL DOCUMENTS NOTED TO BE ACCESSIBLE FOR AUDITING. (SHIPPER, C OF C, M.T.R., M.T.S., INSPECTION REPORT, X-RAY READER SHEETS AND HEAT TREAT CHARTS)	<i>CAZ</i>	11/17/05
NOTICE	RELEASE FROM EIO	PROVIDE DOCUMENTS TO EIO. SENT ON <u>11/21/05</u> BY <u><i>CAZ</i></u> . RECEIVED RELEASE FROM EIO ON _____	Q ENG OR QA MGR	<i>CAZ</i>
490	PACK AND SHIP	PACKAGE AND SHIP TO MAJOR TOOL.		
1000	REVISION HISTORY	ORIGINAL 12-14-04.	CARUUD	



Corrective Action 1308
Carondelet Division - CA / PA / RGA Database
Corrective Action Type NCR
Date 6/13/2005
CA Originator C. Ruud
Pattern Number: C and A Coil Shims 11 Pieces

Description of Defect / Non-Conformance

Chemistry for 11 shim castings is out of specification.

Root Cause

Chemistry specification was not changed in system and not communicated to Lab personnel.

Corrective Action

Specification was corrected in system and Lab personnel trained. Mag permeability was checked on the parts and are less than 1.02u.

Verification of Corrective Action

Chemistries were checked on subsequent parts and are within specification.

Preventive Action

Create Inspection and Test Plan summarizing all requirements.

Estimated Completion Date

6/15/05

Actual Completion Date

Complete.

A handwritten signature in black ink, appearing to read "C. Ruud".

Signed: C. Ruud

CC: Roger Broman, Barry Craig, Joe Edwards, E.J. Kubick

Nonconformance Report: MetalTek CA 1308

Project Disposition: Use as is.

Approvals

Procurement Technical Representative _____
Wayne Reiersen for Phil Heitzenroeder

Responsible Line Manager _____
Mike Cole for Brad Nelson

Nonconformance Report: CA 1323 (phosphorus levels exceeds specification limits for castings C1- C4 and A1 and C1 shim and four Type C and six A coil shims)

Project Disposition:

The erroneous levels were due to calibration errors with the spectrometer. As reported in MTK's attached report, preventive maintenance has since been performed on the spectrometer. The reported chemistry will be accepted for the castings and shims noted above. The specification chemistry will not be changed at this time.

Approvals:

**Phil
Heitzenroeder**

Digitally signed by Phil Heitzenroeder
DN: CN = Phil Heitzenroeder, C = US,
O = PPPL, OU = Mech. Eng. Division
Reason: I agree to 'specified' portions
of this document
Date: 2006.02.21 11:49:56 -05'00'

Procurement Technical Representative

**Brad
Nelson**

Digitally signed by Brad Nelson
DN: cn=Brad Nelson, c=US,
o=ORNL, ou=FED,
email=nelsonbe@ornl.gov
Date: 2006.02.21 14:16:12
-05'00'

Responsible Line Manager:



Corrective Action 1323
Carondelet Division - CA / PA / RGA Database
Corrective Action Type NCR
Date 7/27/2005
CA Originator C. Ruud
Applies to: Coil castings C-1, C-2, C-3, C-4 and A-1 and C 1 shim and four C coil and six A coil shims

Description of Defect / Non-Conformance

Phosphorus levels in material produced to date exceed specification limits. Both phosphorus and sulfur readings reported erroneously in certifications.

Certification reports have shown phosphorus and sulfur levels in the <.01% range. Independent laboratory data confirmed phosphorus in the .018 to .033% range and sulfur in the .005 to .022% range. Actual levels of some tests are above those in PPPL Specification NCSX-CSPEC-141-03-07 Rev 7.

Nonconformance was first suspected as a result of analysis of zoned attached test specimens volunteered by MetalTek International as response to PPPL questions on weighted average chemical analysis and quality of blending in the gating system. Nonconformance was verified on the bars used in the study and has been extended to evaluation of previously poured products.

Root Cause

Specification limits were set below the levels achievable through use of available raw materials. Spectrometer did not properly calibrate for phosphorus and sulfur at levels of specification due to equipment malfunction.

The chemical specification of EIO heats uses alloy CF8MNMn-Mod which incorporates a type standard calibration with a certified reference material (CRM) BS180. This enables the operator of the spectrometer to match the elemental concentrations of this alloy with corrective factors. These factors are determined by analyzing the CRM and having them compared with the calibration curves for each element. The phosphorus and sulfur content have very low measured intensities due to low concentrations. Intermittent failure of the spectrometer intensity measuring card caused higher intensity readings for phosphorus and sulfur. Subsequent checks with the CRM resulted in low corrective factors that were not detected. This in turn resulted in low reported concentrations for the EIO samples. All the major elements, which are measured on other intensity cards, have been closely monitored and matched very well with the CRM and thus were reported correctly.

Corrective Action

Modification to specification for phosphorus and sulfur will be requested. Limits will be set based on process capability and consistent with other stainless steel grades. Replacement of deficient card in spectrometer will be made upon delivery.

Subsequent immediate analysis of chemistry results, obtained by wet analysis, is attached and demonstrate top of specification for sulfur and over specification for phosphorus. The spectrometer manufacturer has performed an analysis to determine the cause of the malfunction and verified that the intensity card has an intermittent fault and must be replaced. The card has been ordered and scheduled for replacement on August 15, 2005.

Until the card is replaced we will be performing additional type standardizations to ensure accurate sulfur and phosphorus analysis. Additionally, for coils made until the card is replaced, an independent laboratory will perform a verification of the chemical analysis.

Verification of Corrective Action

Will be determined at a later date.

Preventive Action

In addition to spectrometer faults, we have identified that the specification ranges for sulfur and phosphorus is unattainable. Analysis and specifications for virgin charge materials predict sulfur at 0.040% maximum and phosphorus at 0.040% maximum. We have no way to remove phosphorus from the melt and do not intentionally add phosphorus. So, the confirmed coil analyses, along with analyses of virgin material heats, demonstrate sulfur in the range of 0.010% to 0.022% and phosphorus in the range of 0.018% to 0.033%. These results are consistent with our charge material analysis. We will request a deviation for phosphorus in the subject parts and also request a permanent specification change to 0.040% maximum for both phosphorus and sulfur, to allow us to provide non-discrepant material. This change will not affect, in any way, the physical properties or material performance because all coils and test material exhibited sulfur and phosphorus within the new ranges despite inaccurate reporting. Other actions: Specifications have been added to the BS 180 standard and the type standard will be measured against the criteria.

Estimated Completion Date

August 15, 2005

Actual Completion Date TBD

Signed: C. Ruud



CC: Jim Galaske, Barry Craig, Joe Edwards, E.J. Kubick

Guide to St Louis Testing Report Dated 7-26-05

Sample name	Sample origin
A1Z1	Cast on bar A-1 coil, zone 1
A1Z2	Cast on bar A-1 coil, zone 2
A1Z3	Cast on bar A-1 coil, zone 3
C1	Cast on bar C-1 coil
C2Z1	Cast on bar C-2 coil, zone 1
C2Z2	Cast on bar C-2 coil, zone 2
C2Z3	Cast on bar C-2 coil, zone 3
C3Z1	Cast on bar C-3 coil, zone 1
C3Z2	Cast on bar C-3 coil, zone 2
C3Z3	Cast on bar C-3 coil, zone 3
F1	Final analysis button from ladle for C-4 coil
F2	Final analysis button from ladle for C-4 coil
F3	Final analysis button from ladle for C-4 coil
P1	Preliminary analysis button from ladle for C-4 coil

Testing is underway of the heat used to pour the four C coil and six A coil shims.

*Attachment to
CA 1323*



Chemical, Metallurgical, Mechanical, Nondestructive, Environmental Testing, Analyses and Field Service.

July 26, 2005
Lab No. 05C-0608
Invoice No. 59891
P.O. No. 21324
Page 1 of 1

METALTEK INTERNATIONAL
8600 Commercial Blvd.
Pevely, MO 63070

Attention: Chuck Ruud

REPORT OF CHEMICAL ANALYSIS

SAMPLE ID: A1 Z1, A1 Z2, A1 Z3, C1, C2 Z1, C2 Z2, C2 Z3,
C3 Z1, C3 Z2, C3 Z3, F1, F2, F3, P1

RESULTS: %

ANALYTE	A1Z1	A1Z2	A1Z3
Sulfur	.013	.005	.010
Phosphorus	.025	.023	.018

ANALYTE	C1	C2Z1	C2Z2	C2Z3
Sulfur	.014	.022	.018	.015
Phosphorus	.018	.024	.021	.025

ANALYTE	C3Z1	C3Z2	C3Z3
Sulfur	.013	.014	.012
Phosphorus	.024	.025	.021

ANALYTE	F1	F2	F3	P1
Sulfur	.014	.015	.012	.010
Phosphorus	.029	.033	.028	.030

Sulfur Test Method: ASTM E1019-03

Phosphorous Test Method: Colormetric

Identification of tested specimen provided by the client.

Robin E. Sinn
Laboratory Director



RES/nmc



Corrective Action 1379
Carondelet Division - CA / PA / RGA Database
Corrective Action Type NCR
Date 8/31/2005
CA Originator C. Ruud
Applies to: Weld Material Lincoln 3018926-78309

Description of Defect / Non-Conformance

Material failed elongation and one of three Charpy impact tests at -320 F. The average of the specimens exceeds the minimum. See S8 of ASTM A 703/A 703M.

Root Cause

The sample of the weld contained defects not detected.

Corrective Action

Retest material already at Lab.

If needed, make a new weld plate after reviewing process with welder and weld another sample.

Verification of Corrective Action

Retest results. If new plates are needed, the new plate will be x-rayed prior to testing.

Estimated Completion Date

9-2-05

Actual Completion Date TBD

Signed: C. Ruud

A handwritten signature in black ink, appearing to be "C. Ruud".

CC: R. Suria, Barry Craig, Joe Edwards, E.J. Kubick

Nonconformance Report: CA1379

Project Disposition:

Since the re-test meets requirements, this NCR can now be considered closed.

Approvals:

Phil
Heitzenroeder

Digitally signed by Phil Heitzenroeder
DN: CN = Phil Heitzenroeder, C = US,
O = PPPL, OU = Mech. Eng. Division
Reason: I am approving this document
Date: 2005.11.07 10:09:53 -0500

Procurement Technical Representative

 11/7/05

Responsible Line Manager:



Corrective Action 1454
Carondelet Division - CA / PA / RGA Database
Corrective Action Type NCR
Date 11/18/2005
CA Originator C. Ruud
Applies to: C-5 Coil casting

Description of Defect / Non-Conformance

Zone 1 Tensile test at 77K failed elongation at 31% compared to the specification minimum of 32%. A retest also failed at 29%. All other properties exceeded the specification of NCSX-CSPEC-141-03-09. See attached summary of room temperature and cryogenic test results.

Root Cause

Zone 1 test samples have solidified with much less superheat than the other zones as a result of their relative orientation in the mold and mold filling. Zone 1 test bars are in the bottom of the drag, zone 2 and 3 are much higher in the mold. Zone 1 test bars are getting the first cold metal poured which explains the fine grain structure versus zones 2 and 3. Photomicrographs verify that zone 1 has much finer grain structure than the other zones, see St Louis Testing lab report 05M1167. To verify our thinking the zone 1 test bar was heat treated for 7 hours at 2050 F, the same as the coil casting. Photomicrographs indicate that the grain structure did not coarsen significantly, see St Louis Testing lab report 05M1182. Therefore we conclude the fine structure caused by cold metal entering the cavity is adversely affecting ductility at cryogenic temperatures. Photomicrographs taken at Westmoreland indicate there were no defects to cause the failure, see attached photos.

Corrective Action

Use as is.

Verification of Corrective Action

TBD

Preventive Action

Possibly relocate the cast on bars.

Estimated Completion Date

TBD

Actual Completion Date

TBD

Signed: C. Ruud

A handwritten signature in black ink, appearing to be "C. Ruud".

CC: Jim Galaske, Barry Craig, Joe Edwards, E.J. Kubick, Jerry Markham, Roger Broman

C-5 Coil

11/18/2005

77K (-320F)

293K (RT)

Casting	Test 1							Test 2						
	Property	Required	C5-1Z	C5-2Z	C5-3Z	C5-1Z	C5-2Z	C5-3Z	Property	Required	C5-1Z	C5-2Z	C5-3Z	
Elastic Modulus	21 Msi (144.8 Gpa)	33	31.8	28	34.5	28.2	25.9	20 Msi (137.9 Gpa)	28.4	27.7	25.9			
0.2% Yield Strength	72 ksi (496.4 Mpa)	112.6	98.3	95.5	111.2	102.5	95	30 ksi	41.5	37.7	37.1			
Tensile Strength	95 ksi (655 Mpa)	182.5	166.1	163.7	177.4	172.3	163.5	78 ksi (537.8 Mpa)	92.9	84.4	83.7			
Elongation	32%	31%	52%	59%	29%	41%	64%	36%	55%	52%	67%			
Charpy V - notch Energy	35 ft. lbs. (47.4 J)	81	73	87				50 ft.-lbs (67.8 J)	130	131	156			

DISPOSITION OF CA 1454 (C5 ELONGATION)

NCSX accepts the 31% elongation (vs. 32% spec. requirement) from one of the test bars from the C5 winding form. However, we request that the details of the proposed corrective action be discussed at a Quality conference call before being implemented.

**Phil
Heitzenroeder**

Digitally signed by Phil Heitzenroeder
DN: CN = Phil Heitzenroeder, C = US,
O = PPPL, OU = Mech. Eng. Division
Reason: I am the author of this
document
Date: 2005.11.22 17:17:09 -05'00'

Tech. Rep.

Brad Nelson

Digitally signed by Brad Nelson
DN: cn=Brad Nelson, c=US,
o=ORNL, ou=FED,
email=nelsonbe@ornl.gov
Date: 2005.11.22 17:20:45 -05'00'

NCSX Core Systems Engrg. Manager



Carondelet Division

8600 Commercial Blvd. - Pevely, MO 63070 USA
Phone: 636-479-4499 - Fax: 636-479-3399

Final Inspection Report

Customer ENERGY INDUSTRIES OF OHIO

Pattern: MCWF-C5 COIL

Order PPPL-FP-LTS-2

ASTM Metal CF8MNMN MOD

Date 11/4/2005

Type Description	Cert Number	Procedure	Acceptance Criteria	Actual
Liquid Penetrant	172810-1	CQP - 300 Rev 9	SEE NOTE	Acceptable
Notes Acceptance per ASTM A903. Acceptance criteria - level 1 for high stressed areas, level 2 for all other areas.				
Mag Perm	172810-1	SOP Mag Perm 100 Rev 1	<1.02	Acceptable
Radiographic	172810-1	Technique # 12726	MSS SP 54	Acceptable
Visual	172810-1	CQP - 500 REV 4	ASTM A802 LEVEL 2	Acceptable

Liquid Penetrant

Technician: Jason Rees
ASNT Level II

Visual

Technician: Jason Rees
ASNT Level II

Respectfully Submitted,
Charles A. Ruud
Quality Assurance Manager

Superior Quality Engineered Metal Products

www.MetalTekInt.Com



Carondelet Division

8600 Commercial Blvd. - Pevely, MO 63070 USA
Phone: 636-479-4499 - Fax: 636-479-3399

Certificate of Conformance

ENERGY INDUSTRIES OF OHIO

Order Number PPPL-FP-LTS-2

Pattern MCWF-C5 COIL

ASTM CF8MNMN MOD

Date 11/4/2005

Cert Number

172810-1

A handwritten signature in black ink, appearing to read "CAR", is positioned above the signature block.

We certify that we have complied in accordance with the drawings(s) and specifications(s) listed on the above purchase order. The articles furnished were made and/or processed from parts and/or materials in accordance with all applicable drawings(s) and specifications(s) pursuant to the afore mention purchase order.

Respectfully Submitted,
Charles A. Ruud
Quality Assurance Manager

Superior Quality Engineered Metal Products

www.MetalTekInt.Com



Carondelet Division

8600 Commercial Blvd. - Pevely, MO 63070 USA
Phone: 636-479-4499 - Fax: 636-479-3399

Final Inspection Report

Customer ENERGY INDUSTRIES OF OHIO
Pattern: SE-141-073 COIL C SHIM
S/N 5

Order PPPL-FP-LTS-2

ASTM Metal CF8MNMN MOD Date 10/28/2005

Type Description	Cert Number	Procedure	Acceptance Criteria	Actual
Liquid Penetrant	S73220-2	CQP - 300 Rev 9	ASTM A903 Level II	Acceptable
Mag Perm	S73220-2	SOP Mag Perm 100 Rev 1	<1.02	Acceptable
Radiographic	S73220-2	Technique # 12726	MSS SP 54	Acceptable
Visual	S73220-2	CQP - 500 REV 4	ASTM A802 LEVEL 2	Acceptable

Liquid Penetrant

Technician: Jim Shanahan
ASNT Level II

Visual

Technician: Jason Rees
ASNT Level II

Respectfully Submitted,
Charles A. Ruud
Quality Assurance Manager

Superior Quality Engineered Metal Products

www.MetalTekInt.Com



3

Carondelet Division

8600 Commercial Blvd. - Pevely, MO 63070 USA
Phone: 636-479-4499 - Fax: 636-479-3399

Certificate of Conformance

ENERGY INDUSTRIES OF OHIO

Order Number PPPL-FP-LTS-2

Pattern SE-141-073 COIL C SHIM

S/N 5

ASTM CF8MNMN MOD

Date 10/28/2005

Cert Number

S73220-2

C shim for C-5 coil was poured from heat number 29198. No weld repairs were necessary.

A handwritten signature in black ink, appearing to read "CAR", is located in the lower right quadrant of the page.

We certify that we have complied in accordance with the drawings(s) and specifications(s) listed on the above purchase order. The articles furnished were made and/or processed from parts and/or materials in accordance with all applicable drawings(s) and specifications(s) pursuant to the afore mention purchase order.

Respectfully Submitted,
Charles A. Ruud
Quality Assurance Manager

Superior Quality Engineered Metal Products

www.MetalTekInt.Com

EIO
Energy Industries of Ohio
SUPPLIER QUALITY RELEASE

		Date: 11-23-05
--	--	----------------

I. General Information:		
Project Name:	Modular Coil Winding Form C5	
PO No:	NCSX-SOW-141-02-01	Rev.: 9
Supplier:	MetalTek	
Procurement Agent:	EIO	
Shipment:	<input checked="" type="checkbox"/> Partial <input type="checkbox"/> Final	

II. Material Description
Casting C5 Coil

III. Release Checklist	
Plan Requirements Complete?	<input checked="" type="checkbox"/> Yes <input type="checkbox"/> No <input type="checkbox"/> N/A (If identified "No" provide explanation in comments section below)
Variations?	<input checked="" type="checkbox"/> Yes <input type="checkbox"/> No <input type="checkbox"/> N/A (If identified "No" provide explanation in comments section below)
Princeton Notified of Shipment?	<input checked="" type="checkbox"/> Yes <input type="checkbox"/> No <input type="checkbox"/> N/A (If identified "No" provide explanation in comments section below)
DCMA Notified of Shipment?	<input checked="" type="checkbox"/> Yes <input type="checkbox"/> No <input type="checkbox"/> N/A (If identified "No" provide explanation in comments section below)
<input checked="" type="checkbox"/> Conditional <input type="checkbox"/> Unconditional Explain conditional releases in comments section.	

IV. Comments
Variances – See attached package for CA's and deviations CA1454 Attached, elongation under spec

By signing below you acknowledge that the casting has met all applicable standards and contractual requirements

V. Supplier Quality Representative Sign Off		
	X	11-23-05
Supplier Quality Representative (SQR) Print/Type Name	Supplier Quality Representative (SQR) Signature	Date

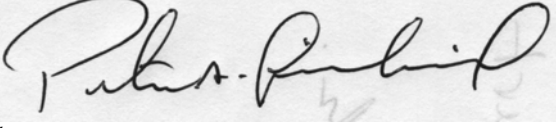
VI. Supplier Approval For Shipment		
Procurement Agent Notified of Shipment	Date: 11-23-05	
Required Vendor Data Ready for Shipment	Date: 11-23-05	
Peter A Djordjevich	 X	11-23-05

EIO
Energy Industries of Ohio
SUPPLIER QUALITY RELEASE

		Date: 11-23-05
--	--	----------------

I. General Information:		
Project Name:	Modular Coil Winding Form C5	
PO No:	NCSX-SOW-141-02-01	Rev.: 9
Supplier:	MetalTek	
Procurement Agent:	EIO	
Shipment:	<input checked="" type="checkbox"/> Partial <input type="checkbox"/> Final	
Supplier's Representative Print/Type Name	Supplier's Signature	Date

1. Enter:
Project Name
PO Number
Supplier
Procurement Agent

2. Enter a brief description of items being released, including applicable drawing number(s), dash or item number(s), drawing revision letter, specification(s), and serial number(s).

3. Self-Explanatory

4. Record any unusual circumstance, such as a conditional release.

5. The Supplier's representative shall sign and date.

7. Signature and date of the Supplier's authorized representative indicating shipping date.

8. In case of partial release, the supplier shall maintain copies of each sequential "Supplier Quality Release" and establish complete accountability of material release on final shipment.

9. Supplier shall include a copy of the completed form with each shipment.