

NCSX
Design Basis Analysis

Stress Analysis of the NCSX Trim Coils

NCSX-CALC-133-001-00

Draft A

05 May 2008

Prepared by:

Art Brooks, Engineering Analyst

I have reviewed this calculation and, to my professional satisfaction, it is properly performed and correct. I concur with analysis methodology and inputs and with the reasonableness of the results and their interpretation.

Reviewed by:

???, Engineering Analyst

Controlled Document
THIS IS AN UNCONTROLLED DOCUMENT ONCE PRINTED.
Check the NCSX Engineering Web prior to use to assure that this document is current.

1.0 Executive Summary

This documents the results of the stress analysis of the NCSX Trim Coils in support of the Final Design Review. It includes the coil conductor and encasing structure up to but not including the support brackets which tie them to the MCWF/TF/PF support structures.

Worse case running load were found to be 80 lb/in for the inner coils and 60#/in for the outer coils. This is driven by the TF field since the trim coils lie just inside the TF coils. All of the GRD scenarios resulted in running loads of 50#/in or less as a result partially of lower TF levels.

The analysis results show the current design to be acceptable. Conservative estimates of the reaction loads are provided as input to the bracket design and for MCWF/TF/PF interface evaluation.

2.0 Assumptions and Notable Concerns

The design is based on a 120 turn copper winding wrapped with CTD -101K insulation turn to turn insulation and groundwrap. The conductor is partially encased by mounting it to a 3/4" 304SS base plate and capturing it with a 3/16" wall 304SS formed U-Channel along the straight legs of the coil and attached to the base plate with a 1/8" weld. The coils are supported off the MCWF/TF/PF supported structure with brackets attached to the base plate. Where the brackets attachments are made, welding of the U-Channels is not accessible and assumed free. There are 4 attachment points per inner trim coil, at or near the corners along the toroidal running legs and unsupported along the radial running legs. The outer trim coils are supported along each of the 4 legs at 2-3 locations each. The conductor is assumed to be free to slide within the case. Analysis was done with and without friction. The conductor is free to lift off along the unsupported corners.

Analysis includes the impact of thermal stresses due to the cool down based on a difference in CTE of 2 m/m-K over the temperature change of 220 K (300K-80K). It is assumed that cool-down is slow enough such that large thermal gradients are not generated between the coils and the MCWF/TF/PF supported structure. An allowable gradient between the structures has not been established.

3.0 Analysis

An ANSYS model was created using the basic geometry defined by the ProE models but simplified to capture significant features. Only the coil centerline geometry from the ProE model was imported into ANSYS. The cross section geometry was modeled parametrically in ANSYS and extruded for each coil. Welds are modeled as coupling between welded interfaces at the top of the U-Channel and base (top) plate. The conductor-case interface was modeled with contact elements. Coefficients of friction of 0 and 0.3 were assumed during the initial analysis to assess impact. The conductor is fully captured by the u-channels along the straight legs but only supported by the plate in the corners where it is free to lift off. The supports are not modeled explicated; only the location of the supports are captured with constraints in the model as shown in the figures below. Reaction loads at the constraints are supplied for use in support bracket and hardware calculations being done outside the scope of this report.

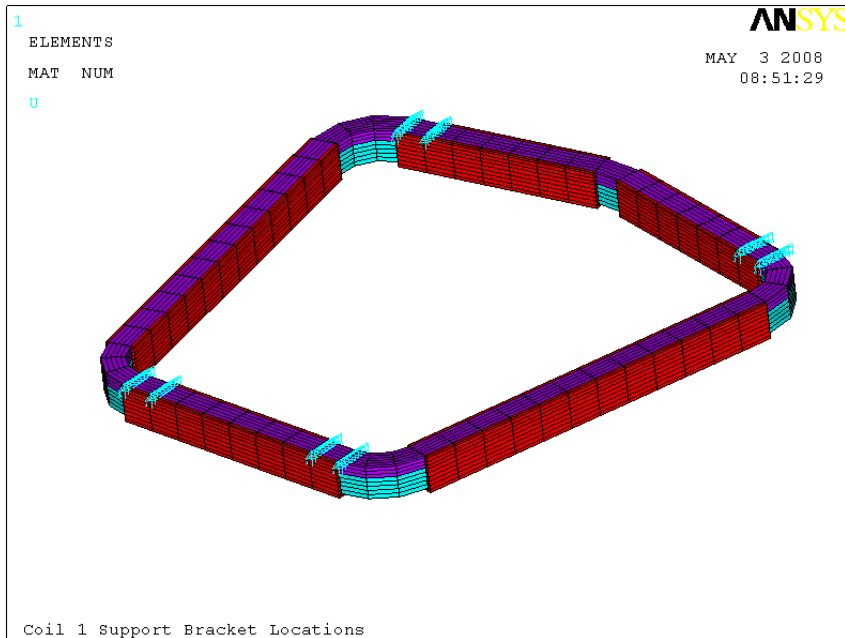
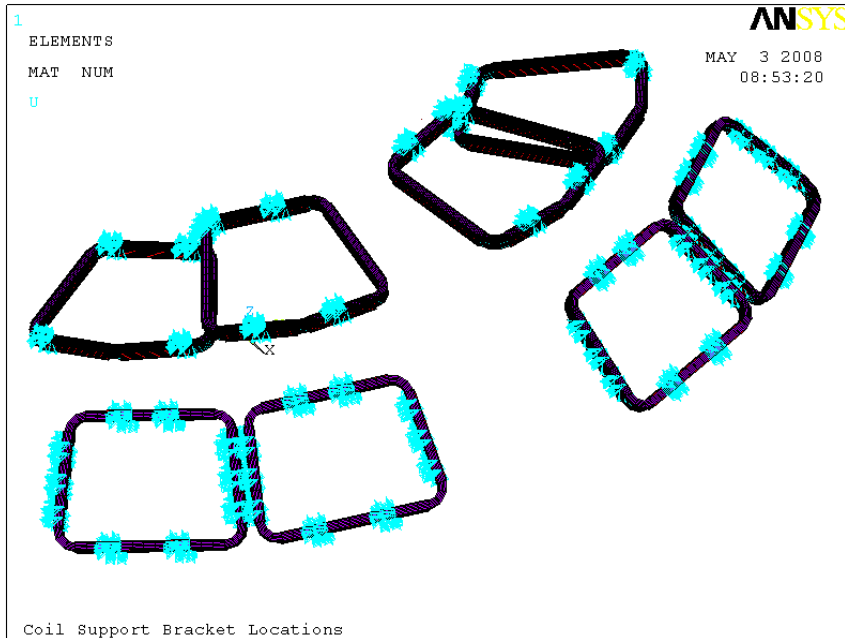

An electromagnetics model was augmented with field sources from the Modular, TF and PF coils taken from an existing model of the Integrated Structure generated by HM Fan. The EM model represents a full period and assumes cyclic symmetry. While this is not true in all cases since the trim coils will be used to correct non stellarator symmetric field errors so will have current distributions that are not stellarator or cyclic symmetric, the main coil fields are symmetric. The forces on the trim coils are dominated by the field

from the Modular, TF and PF coils while the self fields from the trim coils are comparatively small. The trim coils were assumed to carry their design current of 20 kA-turns in all scenarios analyzed. The plot below shows the resultant field from all the coils for the 2T High Beta scenario at t=0.197s.

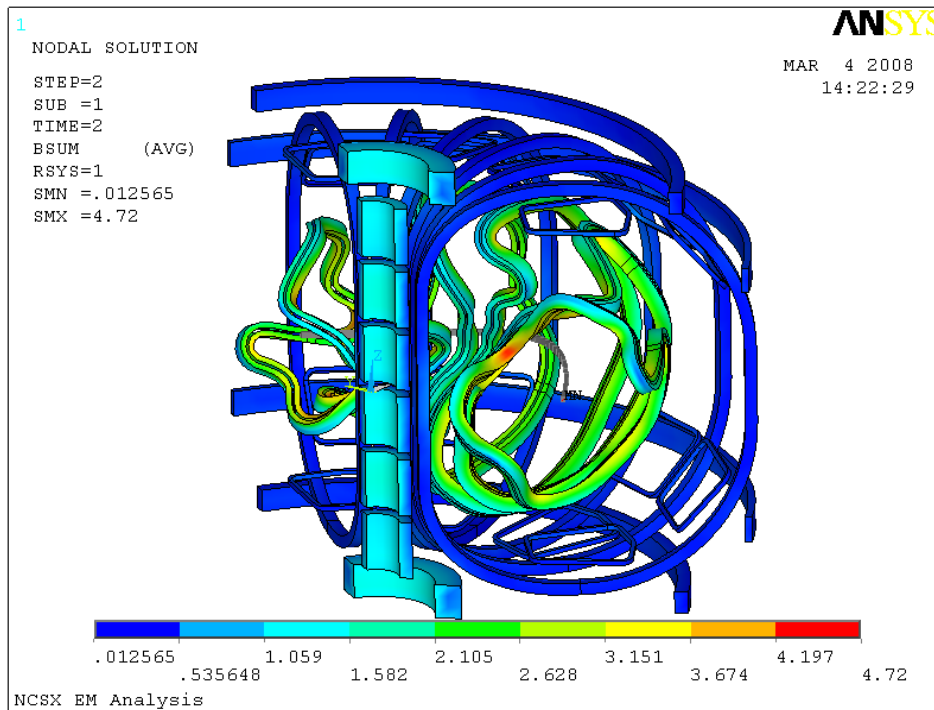

The running load on the trim coils was considered to be the best metric for identifying worse case scenarios to consider for detailed analysis since the response is driven by flexure of the coils between their supports. Alternatively the net force on the coils could have been used but this was not considered representative since there are large opposing forces in the coils. A scan of the expected operating scenarios given in the GRD and several additional flexibility requirements provided identified the worse case running load on the trim coils at their design current of 20 kA-t to be 80 lb/in for the inner coils and 60#/in for the outer coils. This is driven by the TF field since the trim coils lie just inside the TF coils. All of the GRD scenarios resulted in running loads of 50#/in or less as a result partially of lower TF levels.

The loads were checked with an independent FORTRAN code called forces5.f which was then used to scan thru all the GRD scenarios and time points plus additional physics flexibility cases. The results are tabulated below.

Scenario	Time	Running Load	
		N/m	lb/in
1.2T_Long_Pulse	0	5783	33
	0.1	5783	33
	0.128	3869	22
	0.228	5467	31
	1.728	5464	31
1.7_Ohmic	0	8285	47
	0.1	8285	47
	0.14	4990	28
	0.24	4951	28
	0.44	4877	28
1.7T_High_beta	0	8283	47
	0.1	8283	47
	0.14	4893	28
	0.24	7531	43
	0.44	7531	43

Scenario	Time	Running Load	
		N/m	lb/in
2T_High_Beta	0	6595	38
	0.05	6595	38
	0.097	5783	33
	0.192	8773	50
	0.197	8773	50
320KA_Ohmic	0	5573	32
	0.1	5573	32
	0.206	6692	38
	0.306	6687	38
	0.506	6679	38
0.5T_TF		13944	80
iota/shear scan	-0.10	6882	39
	0.19	13752	80
	0.20	6178	35
	0.65	10040	57

The forces on the coil are shown below for the $\iota=0.19$ case which gave rise to the largest running load of 80 lb/in on the inner coils. The outer coils see a lesser value of 60 lb/in. The loads are greatest on the radial legs which cross the TF field and show the characteristic $1/r$ drop in magnitude.

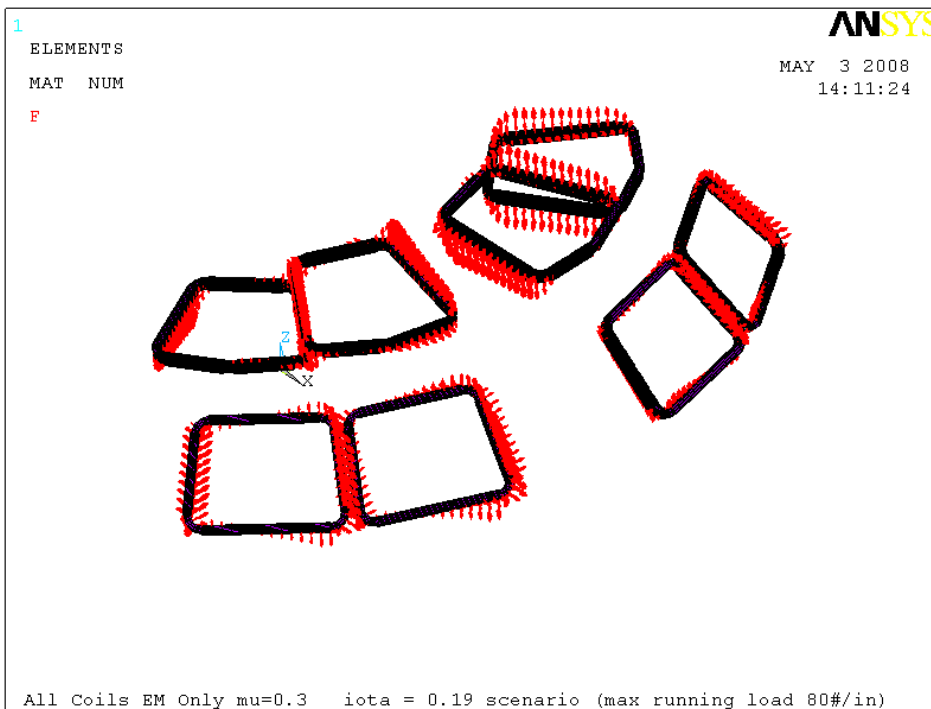

Material properties for the coils and support are taken from the NCSX Online Material Database:

Trim Coils Material Properties

			Epoxy - CTD-101K		Copper		SS 304	
			RT	80K	RT	80K	RT	80K
Modulus	E	Gpa	12.9	16.7	125	137	200	
Poisson's Ratio	mu			0.27	0.34	0.34	0.29	
Thermal Coef of Expansion	alp	1e-6/K			16.70	8.30	16.60	
Average from RT		1e-6/K		10.00	16.7	14	16.6	12.3
Yield Strength		Mpa			240	270	240	485
					(10% Cold Work)			
Ultimate Strength	Ut	Mpa					620	1585
Compressive Strength	Uc	Mpa						
Shear Strength		MPa		108				
References			CTD Technology Development, Inc		NIST Monograph 177 Prop of Cu ... at Cryo Temps		Allegheny Ludlum Tech Data Blue Sheet	

Thermal Mismatch	
Cu_alp-SS_alp	2 1e-6/K
strain, e	0.00044
eE	60.3 Mpa
	8.7 Ksi

The conductor was modeled using equivalent properties calculated from a detailed flexural model of (previously) 121 turns with groundwrap. The model was simply supported and the ends and a unit load applied at the center. The flexural modulus was calculated as it would be for a flexural test setup:

$$E_b = \frac{PL^3}{4bh^3d_{\max}}$$

where

P is the applied load

L is the length of the test specimen

b is the section width

h is the section height

dmax is the max deflection at load P

For verification, the model was rerun using the equivalent flexural modulus and displacements were checked to assure accurate stiffness representation.

Scaling factors for the copper and insulation stresses were determined by comparing max outer fiber stresses for the insulation in the initial model with the results achieved in the equivalent model. Similarly, max stresses at the copper were compared to their equivalent results. Unlike the insulation, the copper does not experience the extreme fiber stress in bending so its scale factor is further reduced based on distance from the neutral axis. Equivalently the copper stress can be normalized to the peak equivalent stress to determine the scale factor.

Equivalent Flexural Modulus and Stress Scaling for Trim Coils

	E, Mpsi	Sz, psi	E, Mpsi	Sz, psi	Sz/Sz	Sz/Sz_max
Cu Wire	17	18390	5.85	6620	2.78	2.19
Insulation	1.5	2111	5.85	8379	0.25	0.25

Composite
(Flex Model) **5.85**

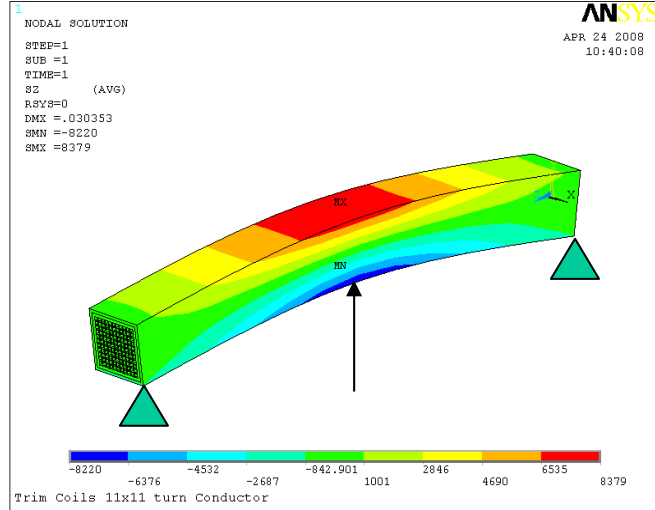

Detailed Model of 121 Turns

Results

The model was run initially with just a single coil to study the relative impact of EM loads and Cool down loads, separately and combined, and to see the effect of the assumed coefficient of friction on the results. There were iterations in the design and analysis until converging on the present configuration.

The results show some sensitivity to the coefficient of friction but there is adequate margin at both extremes. The actual design now calls for potting of the conductor with the case which will make the $\mu=0$ less appropriate. However, we cannot assume a fully bonded coil (which earlier results suggested would have more robust) since the corners are not captured and the conductor will very likely separate from the plate.

While the trim coils are all of only two type (inner and outer), the loading differs from coil to coil as do the details of the supports. The structural model was run with 8 trim coils (half period) to capture the peak stresses in any coil. The results tabulated below are for the $\iota=0.19$ case (largest running load of 80 lb/in in a 'real' scenario)

		Max Von Mises Stress							
		Cond Composite	Copper	Insulation Plate	U Channel				
No Friction Coil1	mu=0.0 CD+EM	32.5	71.5	8.1	113.0	186.0	Mpa	ksi	
		4.6	10.2	1.2	16.1	26.6	Mpa	ksi	
	EM Only	19.9	43.8	5.0	44.2	34.1	Mpa	ksi	
		2.8	6.3	0.7	6.3	4.9	Mpa	ksi	
	CD Only	25.0	55.0	6.3	106.0	198.0	Mpa	ksi	
		3.6	7.9	0.9	15.1	28.3	Mpa	ksi	
Friction Coil1	mu=0.3 CD+EM	27.4	60.3	6.9	120.0	196.0	Mpa	ksi	
		3.9	8.6	1.0	17.1	28.0	Mpa	ksi	
	EM Only	23.1	50.8	5.8	72.7	54.9	Mpa	ksi	
		3.3	7.3	0.8	10.4	7.8	Mpa	ksi	
	CD Only	24.5	53.9	6.1	96.3	174.0	Mpa	ksi	
		3.5	7.7	0.9	13.8	24.9	Mpa	ksi	
Friction All Coils	mu=0.3 CD+EM	33.9	74.6	8.5	166.0	257.0	Mpa	ksi	
		4.8	10.7	1.2	23.7	36.7	Mpa	ksi	
	EM Only	22.9	50.4	5.7	79.2	116.0	Mpa	ksi	
		3.3	7.2	0.8	11.3	16.6	Mpa	ksi	
	CD Only	25.5	56.1	6.4	117.0	188.0	Mpa	ksi	
		3.6	8.0	0.9	16.7	26.9	Mpa	ksi	

The figures below show stress distributions in the full set of coils. What is apparent is that the average stresses are fairly low (plots are very blue). There is peaking in the conductor corners and at the end of the welds that attach the u-channels to the support plate.

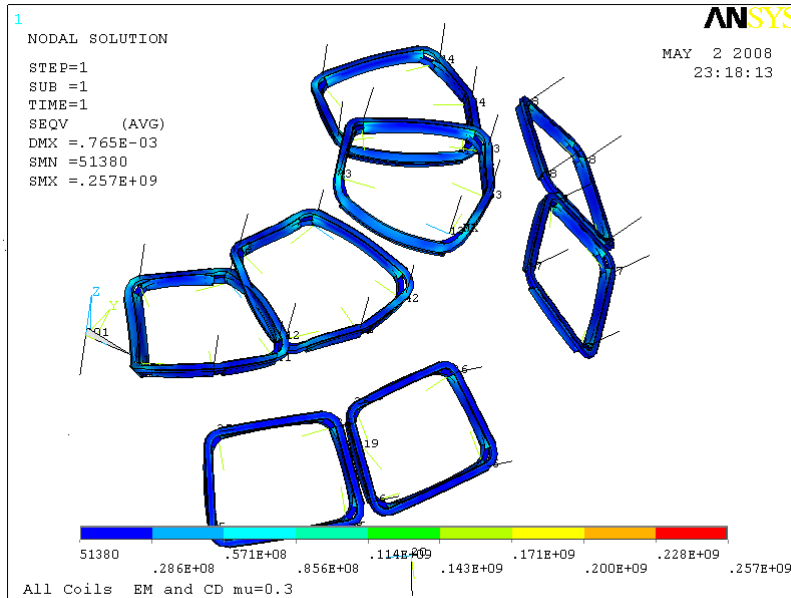

Plot of Coil Assembly Von Mises Stresses

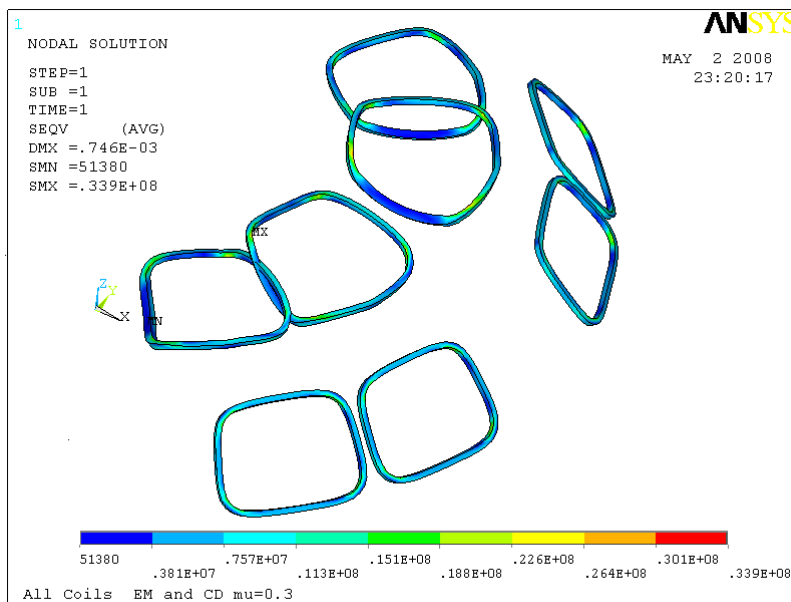

Plot of Conductor Von Mises Stresses (note: equivalent stresses)

The conductor plots show modest stresses where it is captured by the u-channel. At the corners where it is free, bending is greatest. The stresses are scaled by factors presented earlier to give the max insulation and copper stresses in the conductor tabulated above.

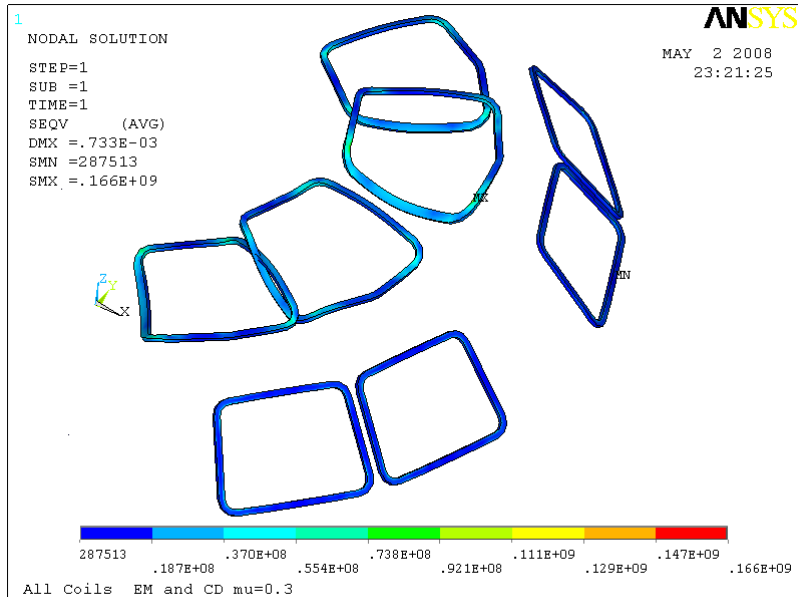

Plot of base (top) plate Von Mises Stresses

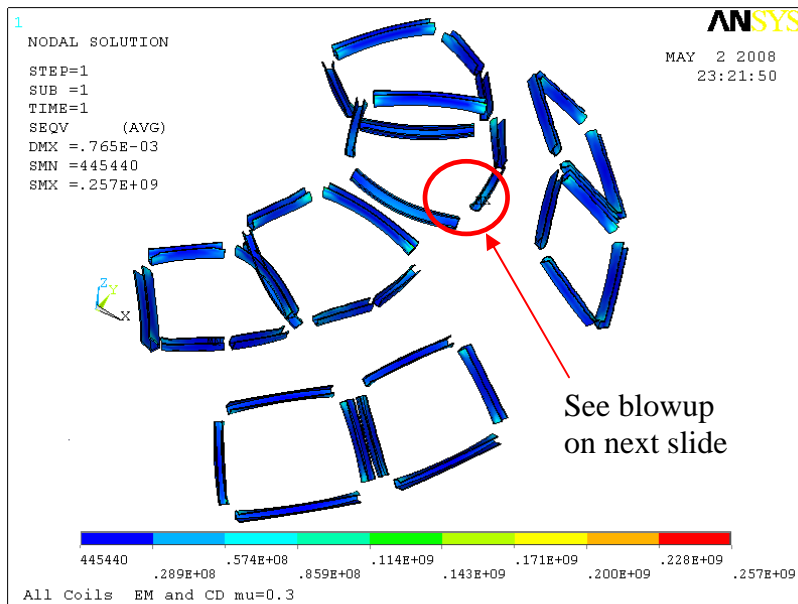

Plot of U-Channel Von-Mises Stresses

The ANSYS plots show high peak stresses at the end of the weld due to the geometric discontinuity there. Generally accepted practice is to look at averaged stresses over the local region to compare to allowable stress limits or for fatigue evaluation purposes.

Within ANSYS this is done by looking at element average stresses as opposed to the peak node stresses normally plotted. The plots below compare the differences. In the region of high stress the averaging makes a significant difference. In regions where the gradients are small, the averaging has little impact.

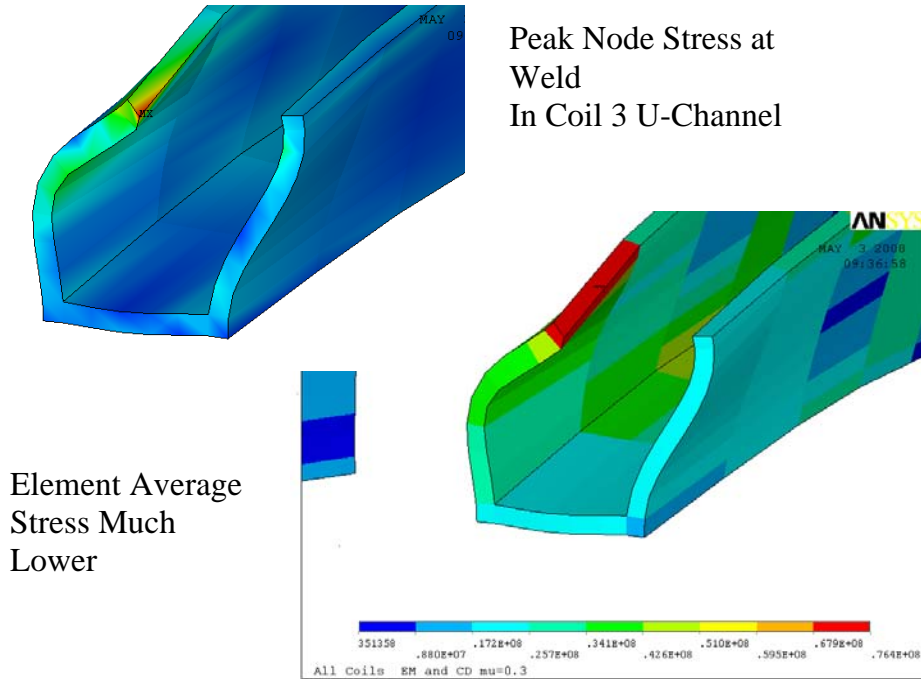

Plot of Peak Stress Region at Weld in U-Channel.

Two additional load cases were run thru the EM and Structural Analysis: the 0.5T TF only case which showed similarly high running loads of 80 lb/in and the 2T high beta scenario which has driven the design of the MCWF/TF/PF support structures. The node stress results are tabulated below:

Friction All Coils iota=0.19	mu=0.3 EM Only	Max Von Mises Stress						
		Cond Composite	Copper	Insulation Plate	U Channel			
		22.9	50.4	5.7	79.2	116.0		Mpa
			3.3	7.2	0.8	11.3	16.6	ksi
0.5T TF		24.1	53.0	6.0	103.0	152.0		Mpa
			3.4	7.6	0.9	14.7	21.7	ksi
2T HB t=0.197s		13.4	29.5	3.4	46.3	38.9		Mpa
			1.9	4.2	0.5	6.6	5.6	ksi

While not shown here, the peak stresses found above occur in similar locations as the earlier case – at the end of welds of the u-channel to the base plate. An examination of the average element stresses for the 0.5T TF case shows the peak stress drops from 21.7 ksi to 8.2 ksi, well with the allowable for 304 SS ($S_m=20$ ksi)

Additional results and information can be found in the attached presentation material prepared in support of the Trim Coil Final Design Review.

4.0 Summary & Commentary

The analysis herein will be used to finalize the selection of materials and welds for the trim coils. Based on the results, it appears that 304 SS is acceptable for both the plate and the u-channel.

Trim Coils Final Design Review Supporting Stress Analysis

Art Brooks
5 May 2008

1

Trim Coil Stress Analysis Overview

- ProE Geometry
- Finite Element Modeling Features
- Force Scan of Many Load Cases
 - Establish running load of 80#/in as worse case
- Local Model of Conductor Copper/Insulation to establish equivalent flexural properties and stress scale factors
- ANSYS Detailed Stress Plots
- Summary Stress Table

2

Inner Trim Coil

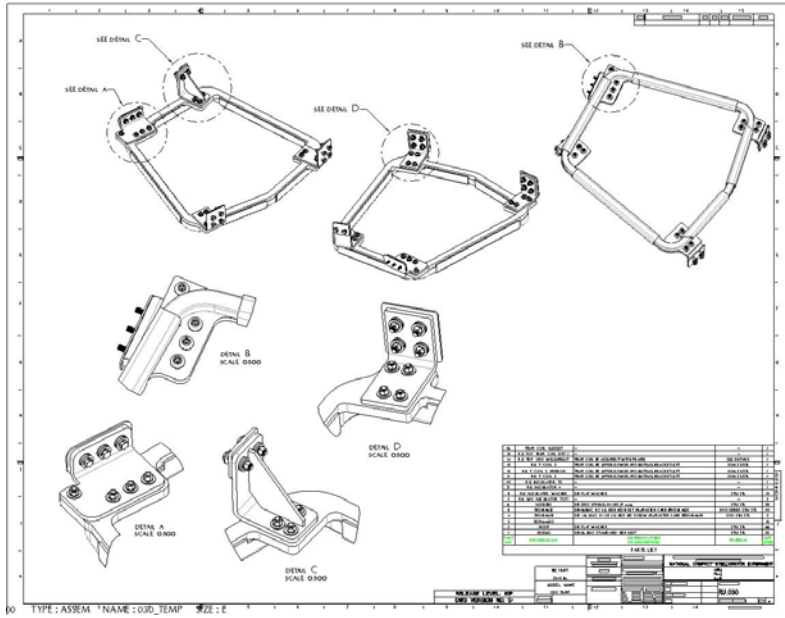

Outer Trim Coils (Top and Bottom)

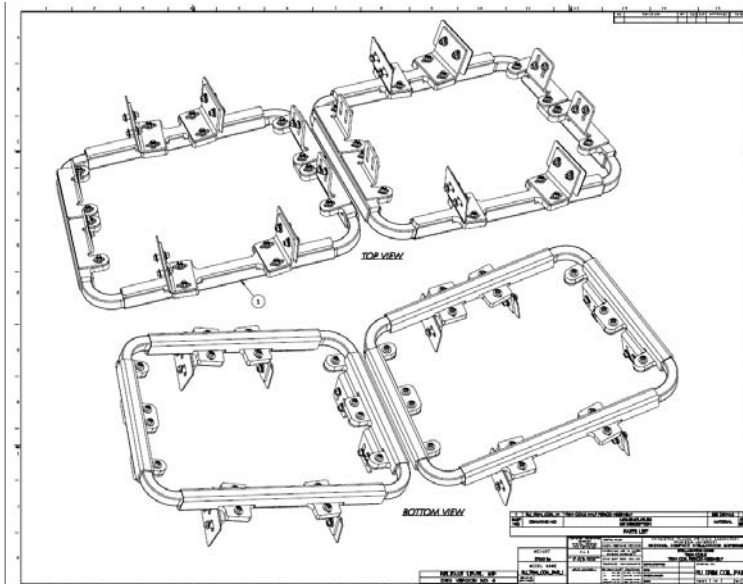

Finite Element Model Features

- Coil Modeled with Composite Properties for Copper and Insulation to minimize model size
 - Resultant plotted stress values must be scaled accordingly (~x2.2 for Cu, x0.25 for Insulation based on flexure)
- U Channels and Base (Top) Plate welded to form partial case
- Conductor free in corners
- Coil – Case contact assumes coefficient of friction of 0.3
- Supports model with simple fixed constraints at support locations
- Loading includes EM and Thermal Cool down
 - Since case is mounted to MCWF/TF/PF Structure, Only differential thermal contraction assumed

5

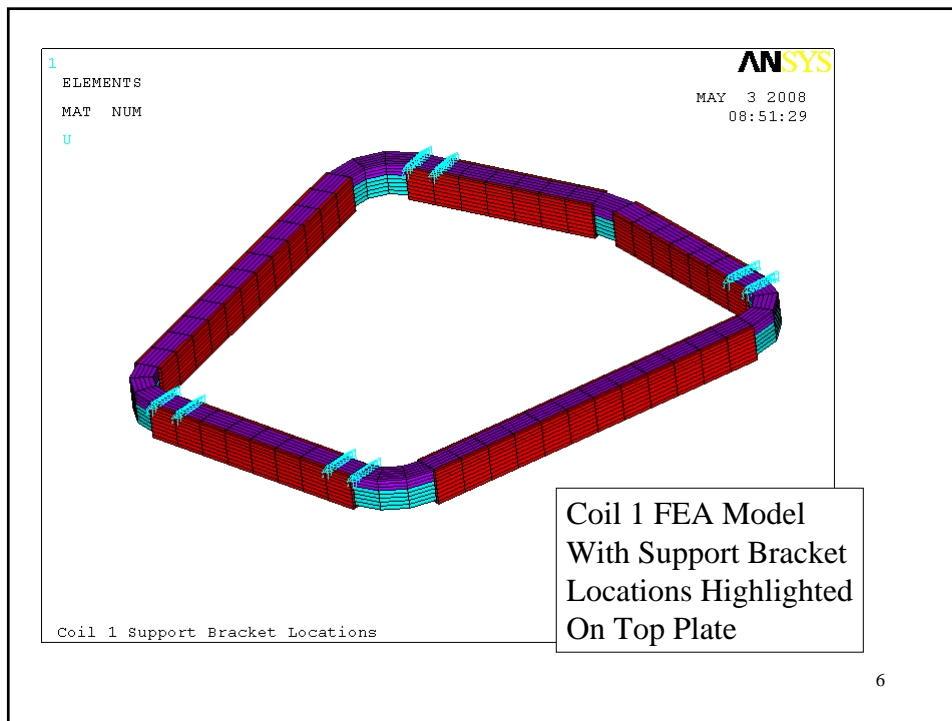

6

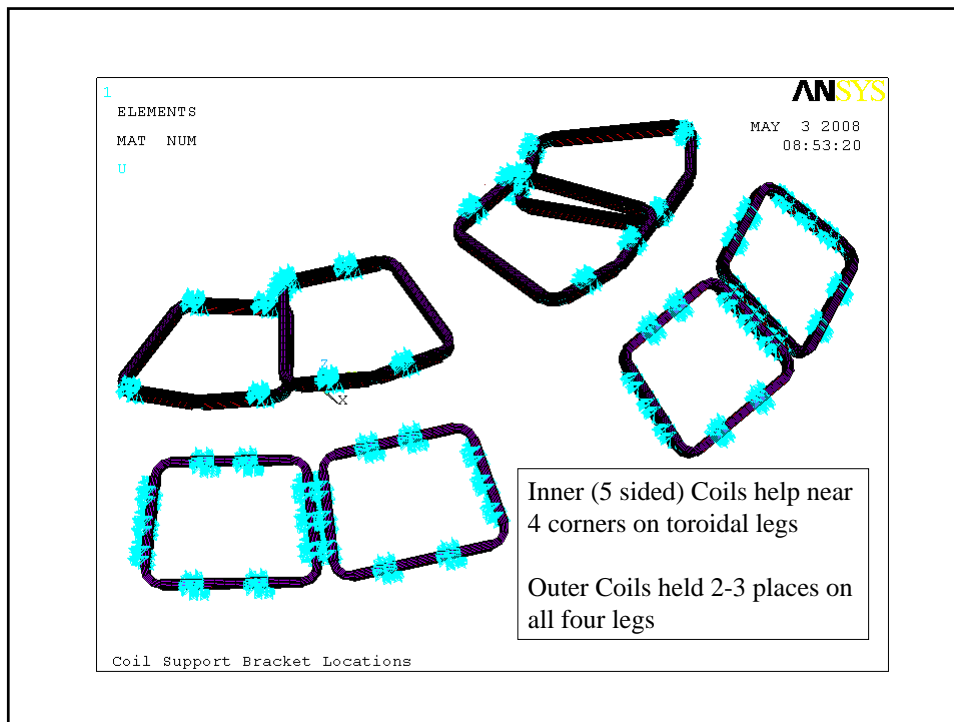

Load Cases Investigated for EM Forces

- All GRD Load Cases at Multiple (5) time points
 - Additional Flexibility Cases Identified by Physics
 - Iota Scan (2)
 - Shear Scan (2)
 - **Max Running Loads Found**
 - 80 lb/in Inner Coils
 - 60 lb/in Outer Coils
- 2T High Beta
 - 1.7T High beta
 - 1.2T Long Pulse
 - 1.7T Ohmic
 - 320KA Ohmic
 - 0.5 T TF
 - Iota/Shear Scan
 - iota -0.10
 - **iota 0.19 (High TF Field)**
 - iota +0.20
 - iota 0.65

Running Load Comparison

Scenario	Time	Running Load	
		N/m	lb/in
1.2T_Long_Pulse	0	5783	33
	0.1	5783	33
	0.128	3869	22
	0.228	5467	31
	1.728	5464	31
1.7_Ohmic	0	8285	47
	0.1	8285	47
	0.14	4990	28
	0.24	4951	28
	0.44	4877	28
1.7T_High_beta	0	8283	47
	0.1	8283	47
	0.14	4893	28
	0.24	7531	43
	0.44	7531	43

Scenario	Time	Running Load	
		N/m	lb/in
2T_High_Beta	0	6595	38
	0.05	6595	38
	0.097	5783	33
	0.192	8773	50
	0.197	8773	50
320KA_Ohmic	0	5573	32
	0.1	5573	32
	0.206	6692	38
	0.306	6687	38
	0.506	6679	38
0.5T_TF		13944	80
iota/shear scan	-0.10	6882	39
	0.19	13752	80
	0.20	6178	35
	0.65	10040	57

9

Iota = 0.19 Scenario Force Distribution

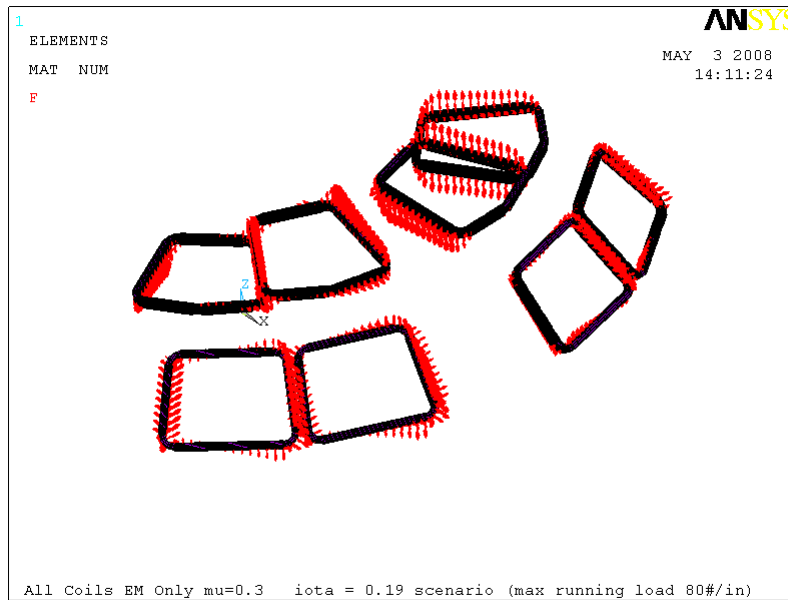

Force Scan Done with FORTRAN Code Benchmarked with ANSYS

Benchmark of Trim Coil Forces - Filament Model vs ANSYS Model Net Force On Trim Coils for Worse Case Scenario (2T HB t=0.197s)

		Coil 1	Coil 2	Coil 3	Coil 4	Coil 5	Coil 6	Coil 7	Coil 8
ANSYS	FX	-2096.4	-831.7	567.4	-422.2	-1155.9	2626.5	-1147.6	-322.6
	FY	-1817.0	993.9	4403.7	315.5	-3447.5	-3114.4	-268.2	-1124.0
	FZ	-3853.4	4882.3	2764.3	-1755.4	2100.1	1884.8	-2130.1	-1132.7
	Fnet	4748.1	5051.3	5230.3	1832.8	4199.0	4488.9	2434.4	1628.0
Forces5.f	FX	-2101.1	-837.3	554.6	-422.4	-1168.0	2602.4	-1171.4	-334.2
	FY	-1827.6	985.4	4410.9	300.2	-3440.6	-3112.0	-271.5	-1135.8
	FZ	-3853.1	4940.3	2777.2	-1762.7	2088.0	1861.9	-2160.0	-1163.7
	Fnet	4754.1	5106.7	5241.8	1837.3	4190.7	4463.6	2472.2	1660.1
Ratio	FX	1.00	0.99	1.02	1.00	0.99	1.01	0.98	0.97
	FY	0.99	1.01	1.00	1.05	1.00	1.00	0.99	0.99
	FZ	1.00	0.99	1.00	1.00	1.01	1.01	0.99	0.97
	Fnet	1.00	0.99	1.00	1.00	1.00	1.01	0.98	0.98

Forces in Newtons

11

Material Properties taken from NCSX Online Materials Database

Trim Coils Material Properties

			Epoxy - CTD-101K		Copper		SS 304	
			RT	80K	RT	80K	RT	80K
Modulus	E	Gpa	12.9	16.7	125	137	200	
Poisson's Ratio	mu			0.27	0.34	0.34	0.29	
Thermal Coef of Expansion	alp	1e-6/K			16.70	8.30	16.60	
Average from RT		1e-6/K		10.00	16.7	14	16.6	12.3
Yield Strength		Mpa			240	270	240	485
					(10% Cold Work)			
Ultimate Strength	Ut	Mpa					620	1585
Compressive Strength	Uc	Mpa						
Shear Strength		MPa		108				
References			CTD Technology Development, Inc		NIST Monograph 177 Prop of Cu ... at Cryo Temps		Allegheny Ludlum Tech Data Blue Sheet	

Thermal Mismatch	
Cu_alp-SS_alp	2 1e-6/K
strain, e	0.00044
eE	60.3 Mpa
	8.7 Ksi

12

Conductor Modeled with Equivalent Properties calculated from Flexural Modulus Simulation

Equivalent Flexural Modulus and Stress Scaling for Trim Coils

	E, Mpsi	Sz, psi	E, Mpsi	Sz, psi	Sz/Sz	Sz/Sz_max
Cu Wire	17	18390	5.85	6620	2.78	2.19
Insulation	1.5	2111	5.85	8379	0.25	0.25

Composite
(Flex Model)

5.85

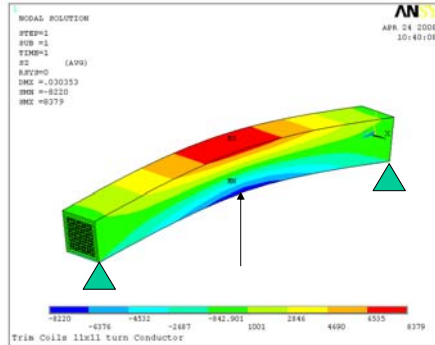

Detailed Model of
121 Turns

13

ANSYS Results Plots Worse Case Running Load of 80#/in

- Coil 1 EM + CD $\mu = 0$
- Coil 1 EM Only $\mu = 0$
- Coil 1 CD Only $\mu = 0$
- Coil 1 EM + CD $\mu = 0.3$
- Coil 1 EM Only $\mu = 0.3$
- Coil 1 CD Only $\mu = 0.3$
- All Coils EM + CD $\mu = 0.3$
- All Coils EM Only $\mu = 0.3$
- All Coils CD Only $\mu = 0.3$
- 4 Plots per Case Shown
 - All
 - Conductor Only
 - Top Plate Only
 - U Channels Only
 - + Other Details in some cases

14

Coil 1 EM + CD $\mu = 0$

15

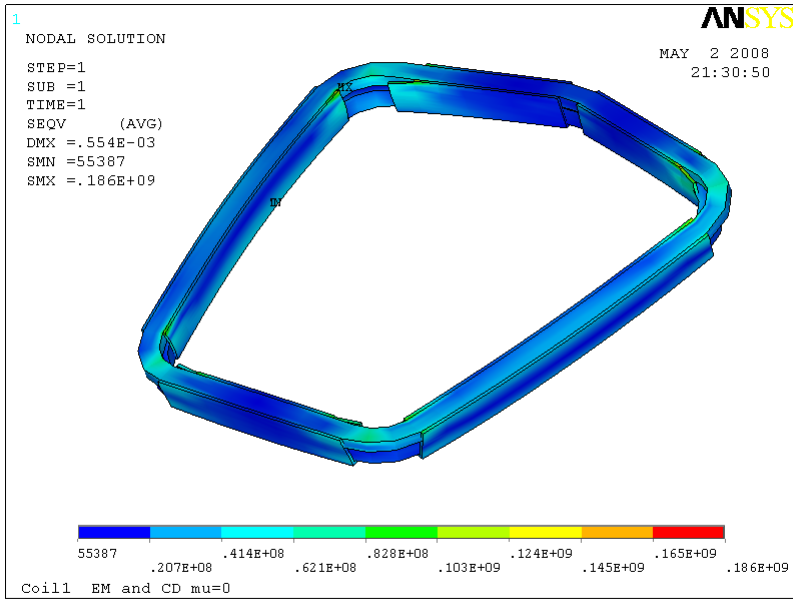

6

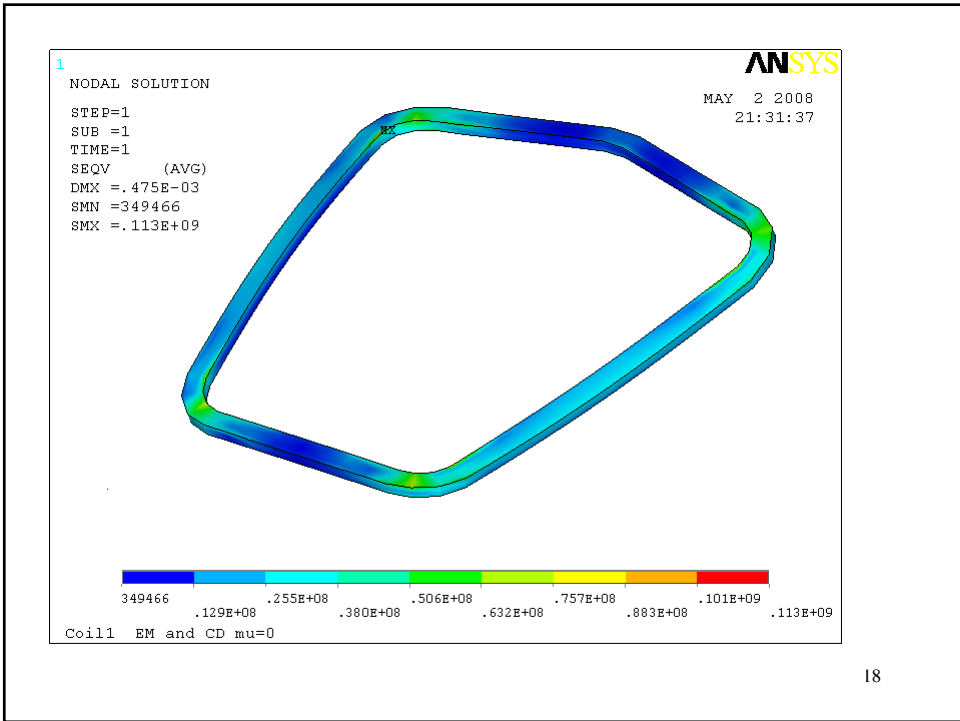
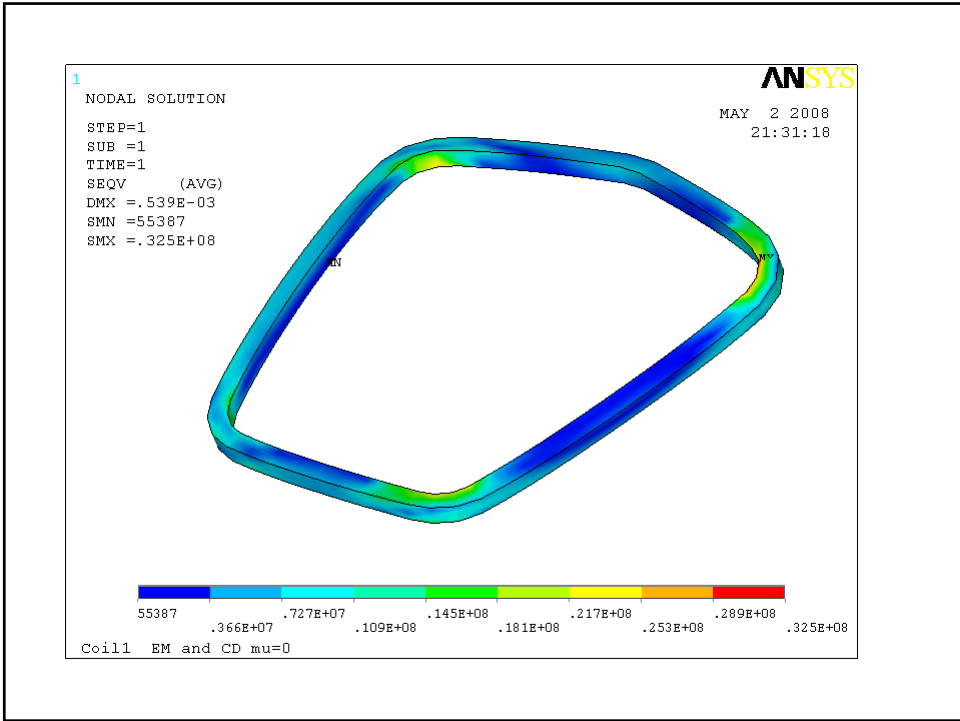

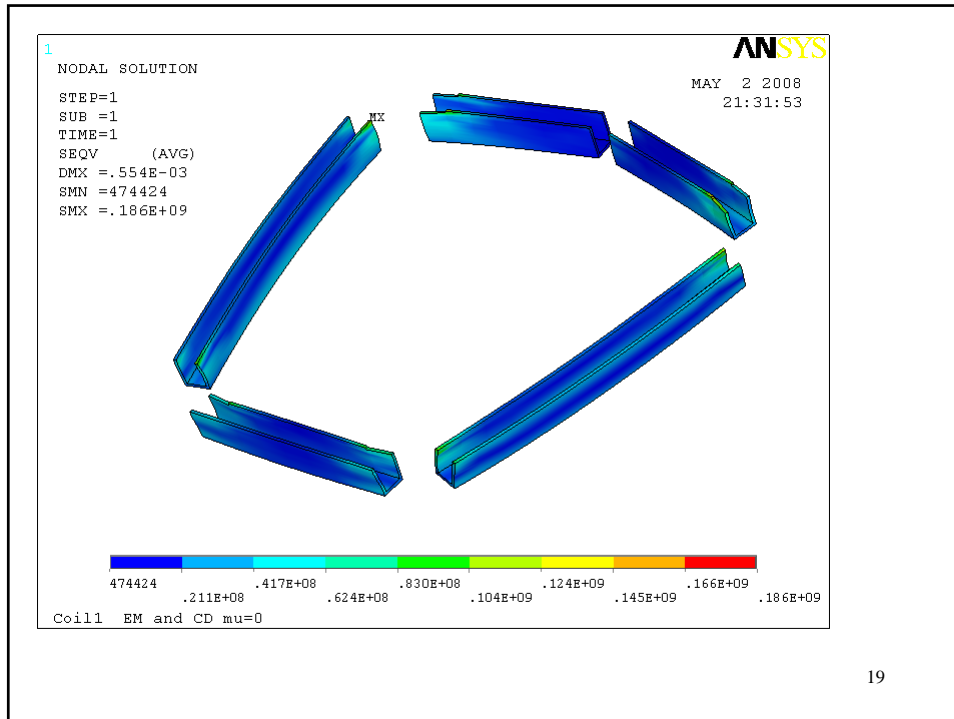

Coil 1 EM Only $\mu = 0$

20

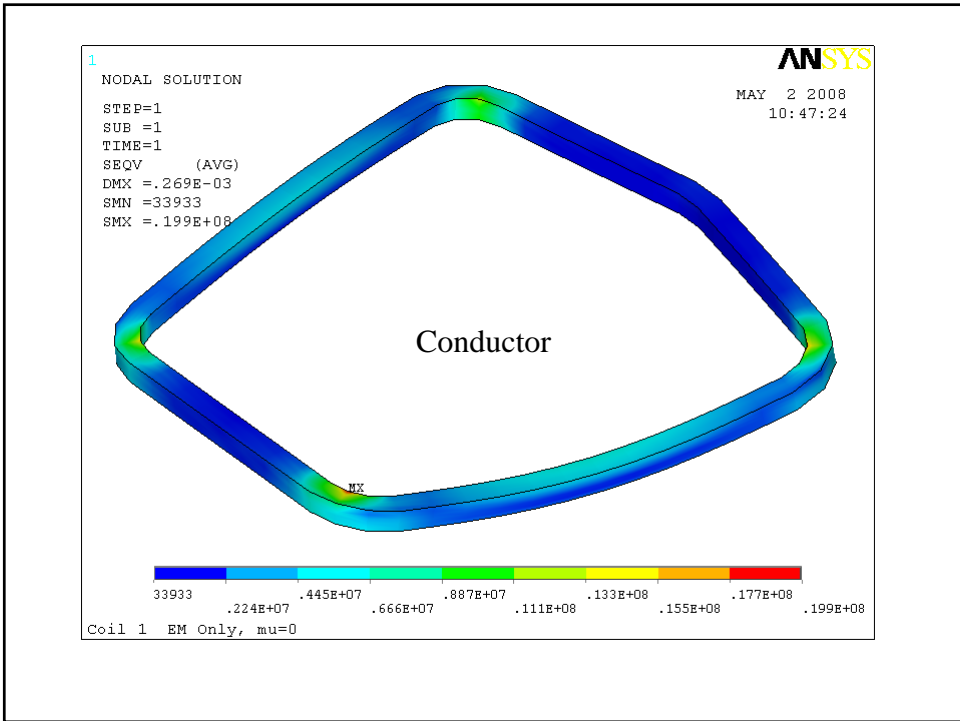
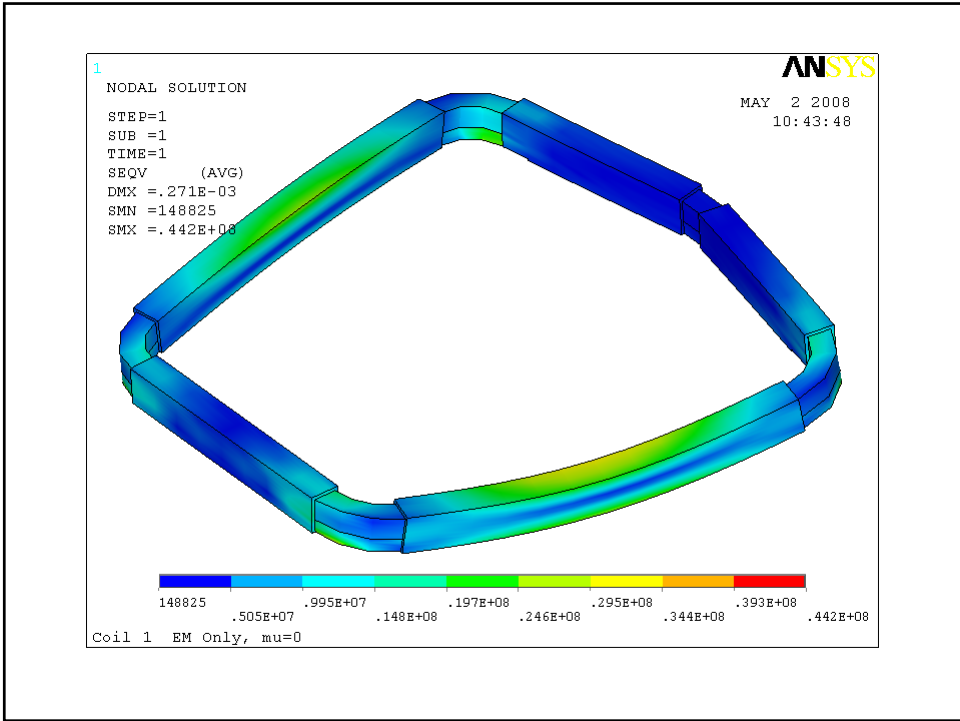

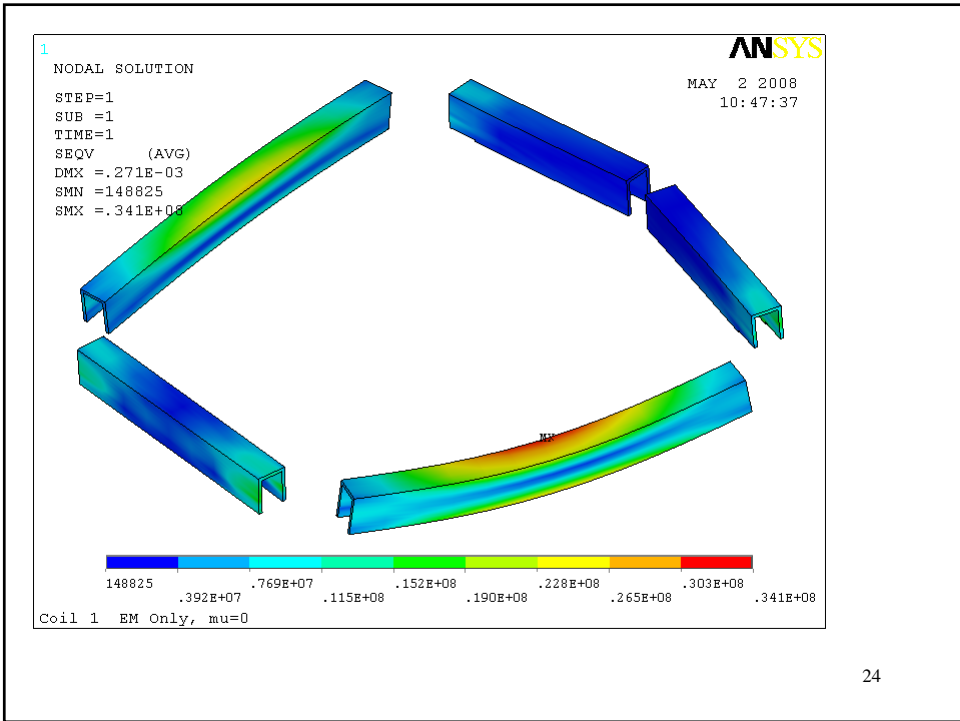
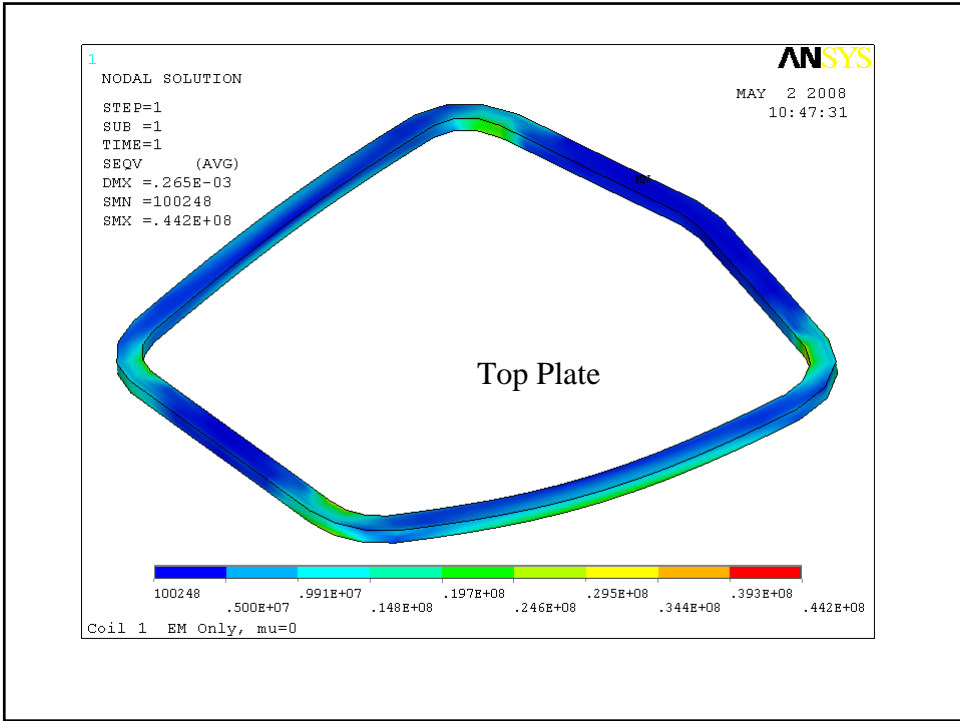

Coil 1 CD Only $\mu = 0$

25

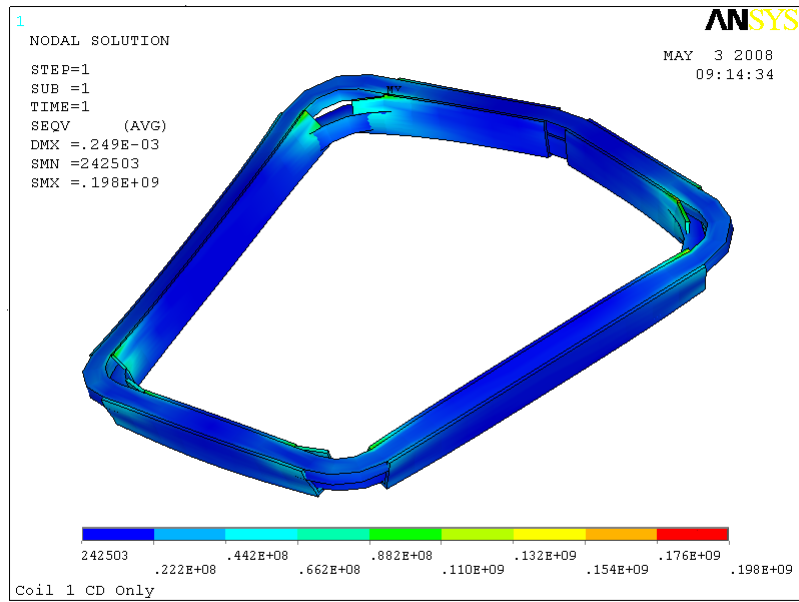

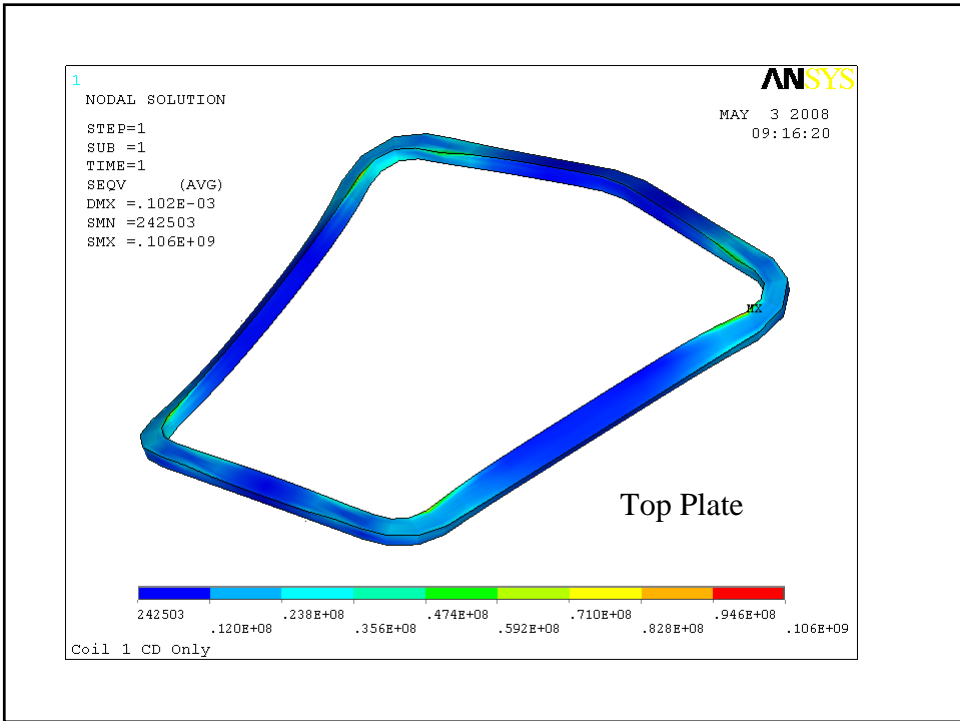
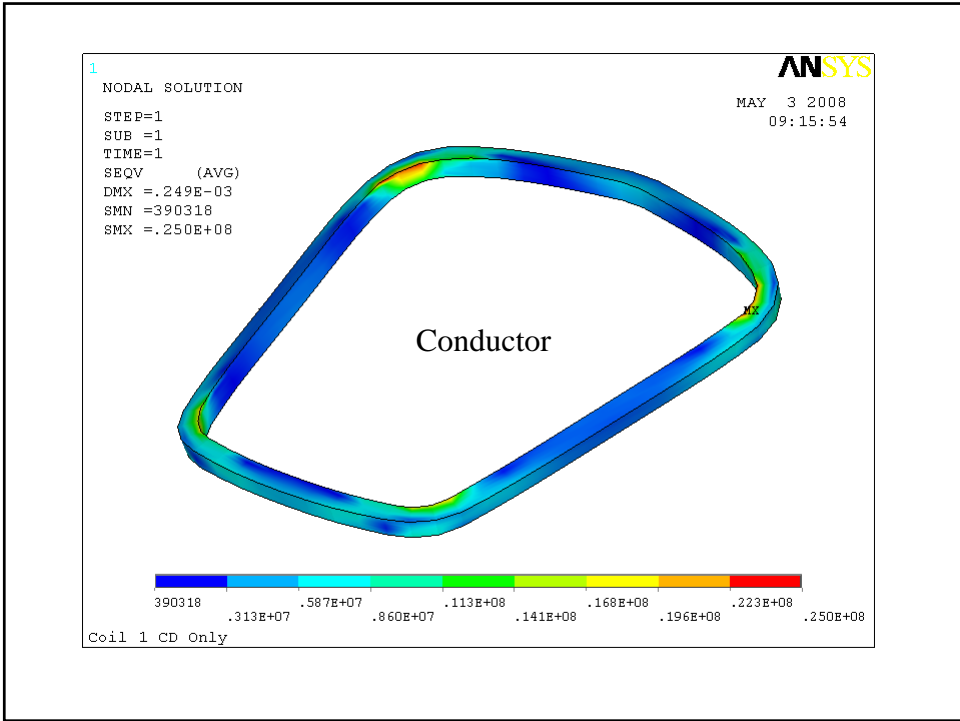

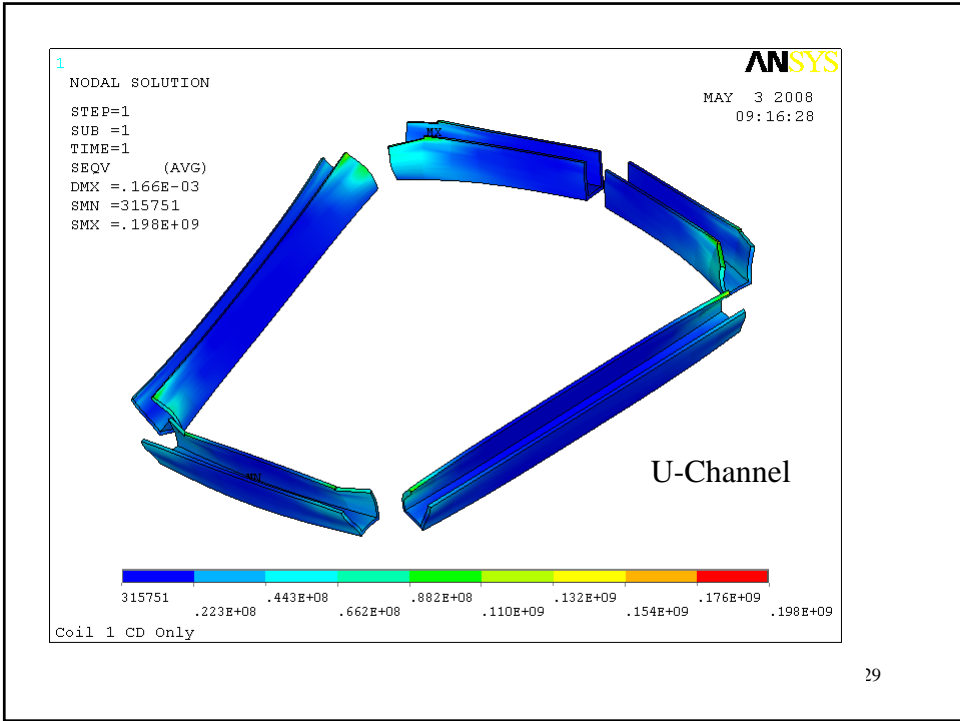

Coil 1 EM + CD $\mu = 0.3$

30

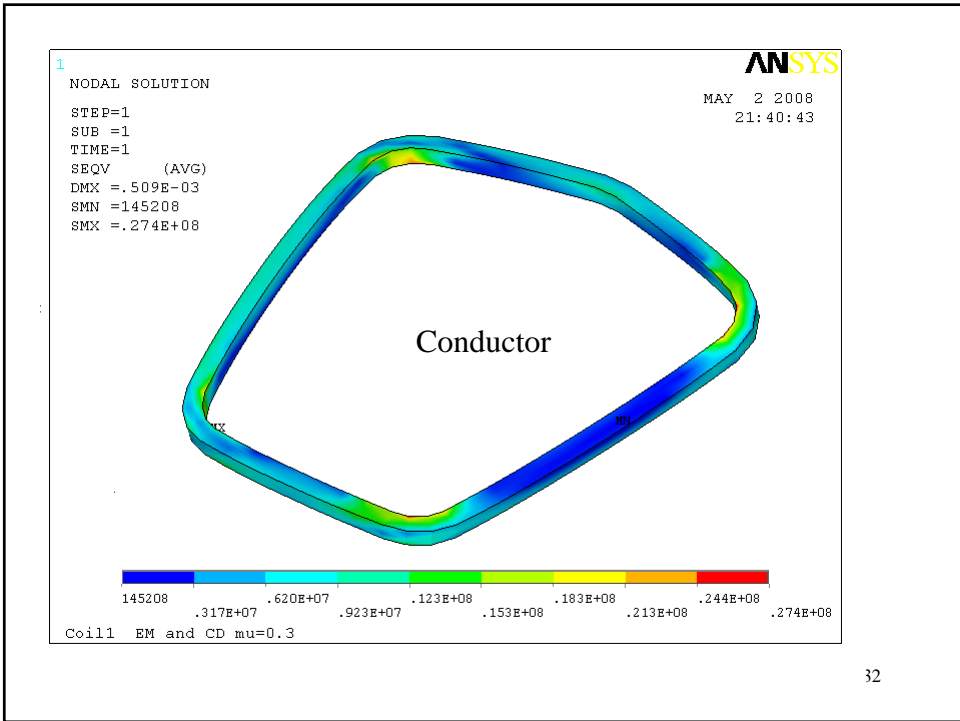
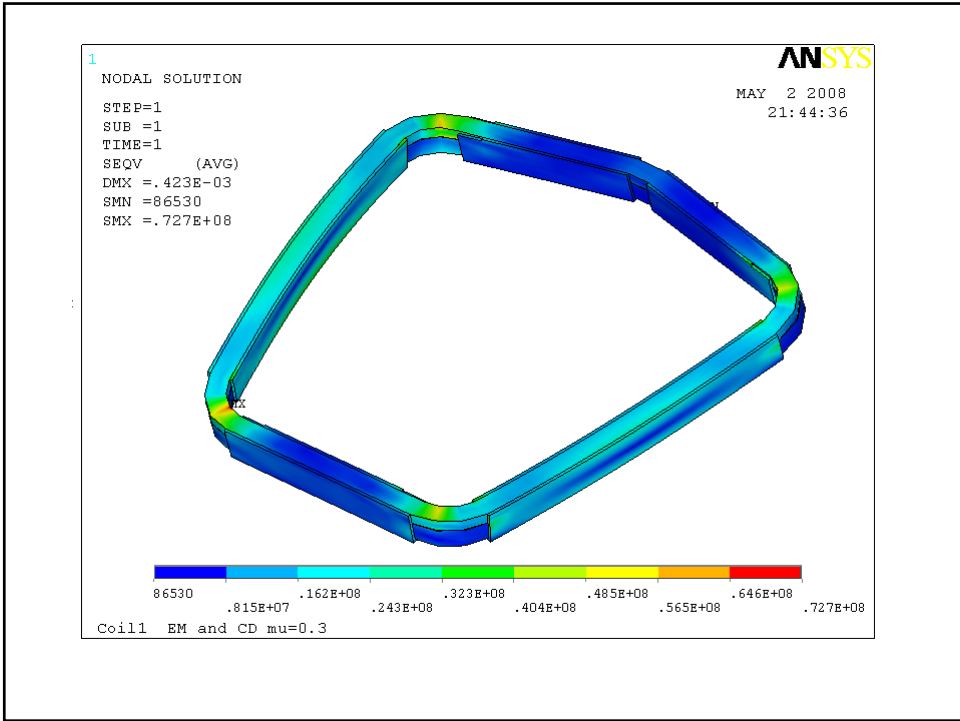

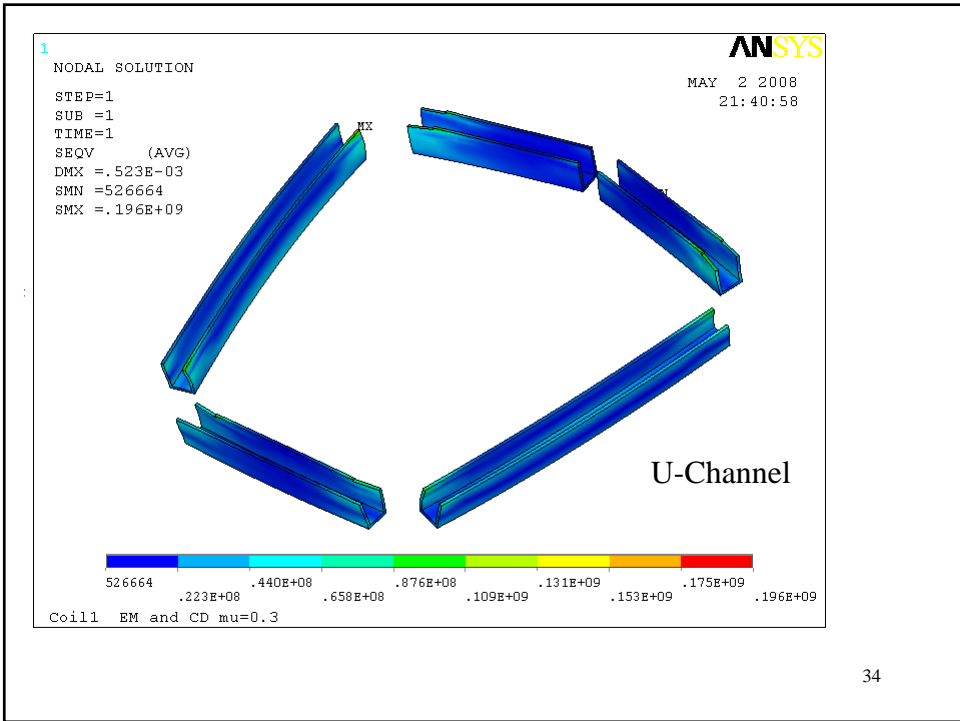
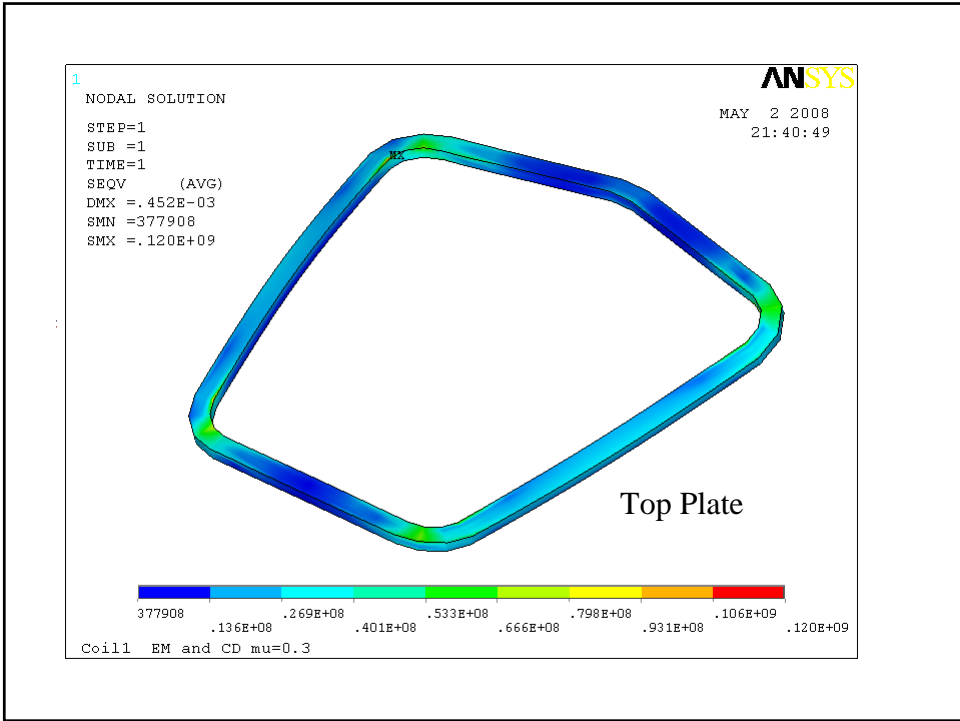

Coil 1 EM Only $\mu = 0.3$

35

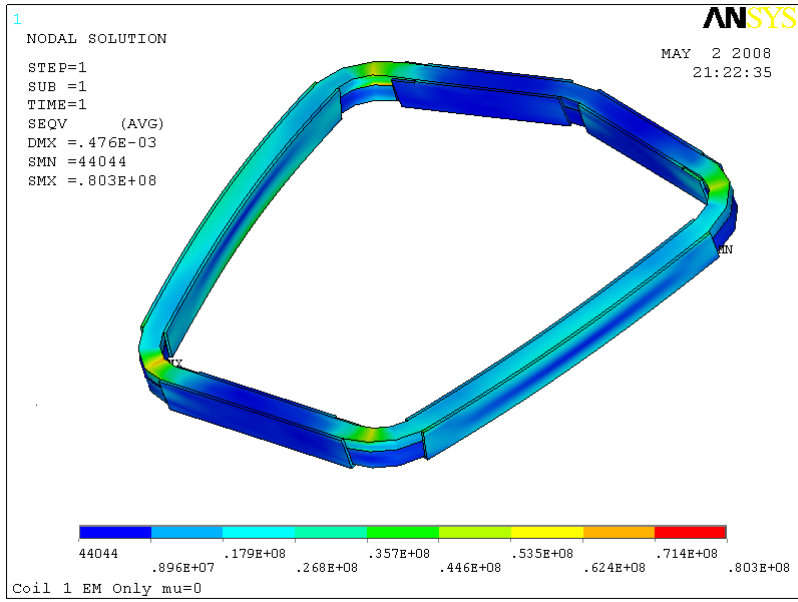

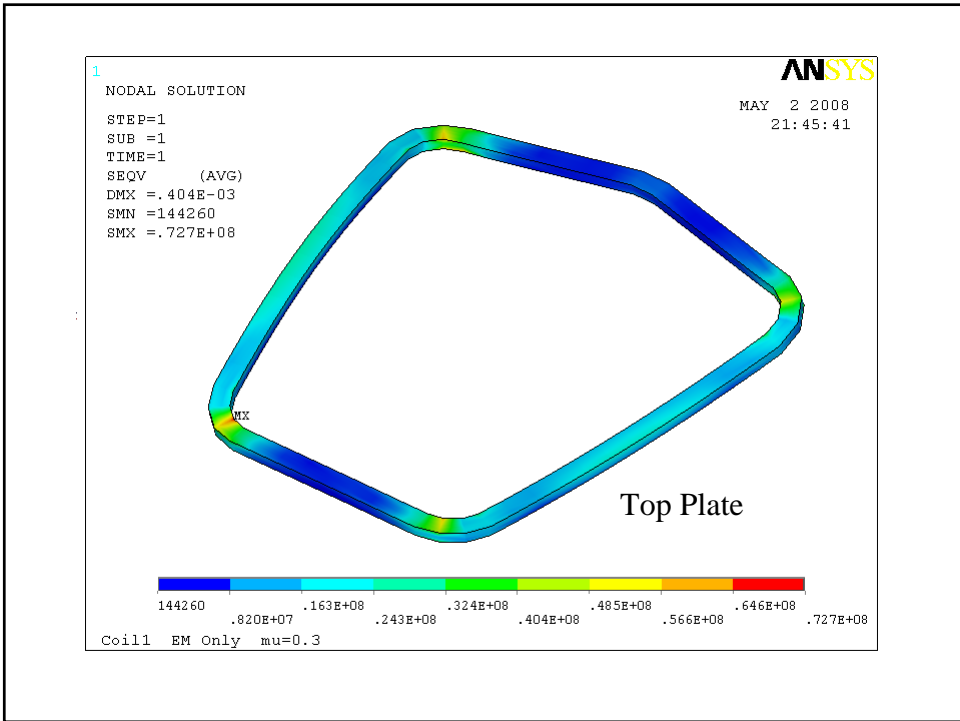
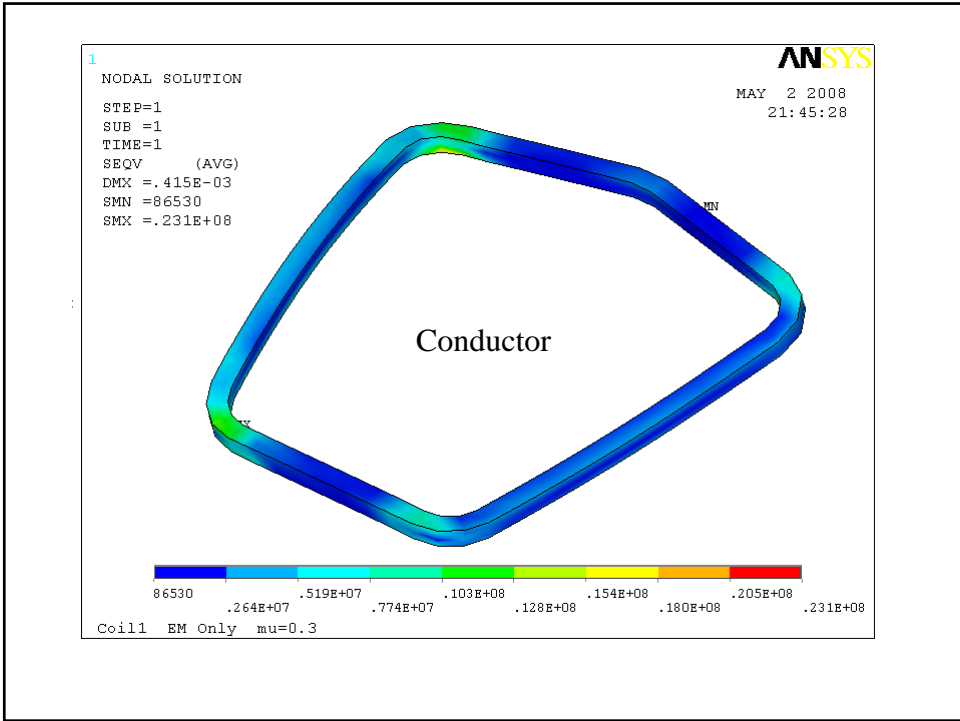

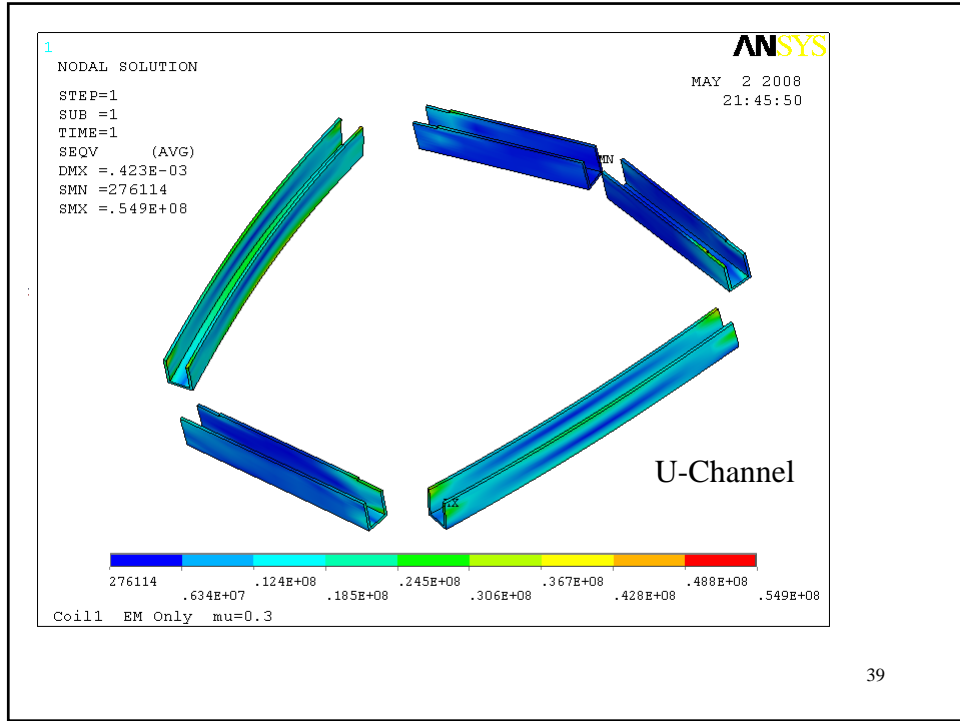

Coil 1 CD Only mu = 0.3

40

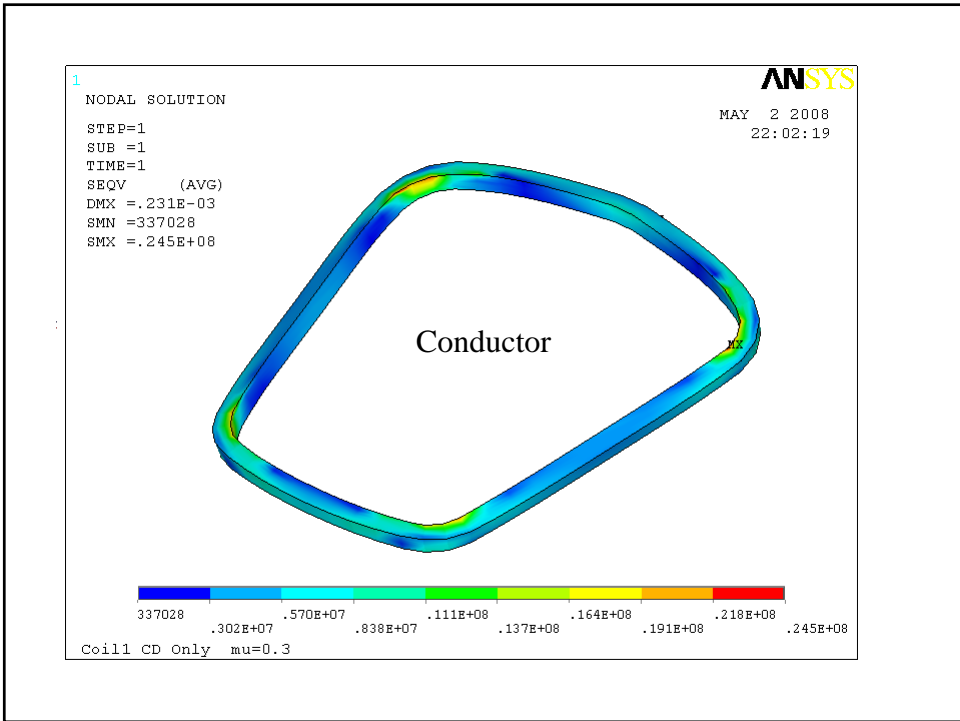
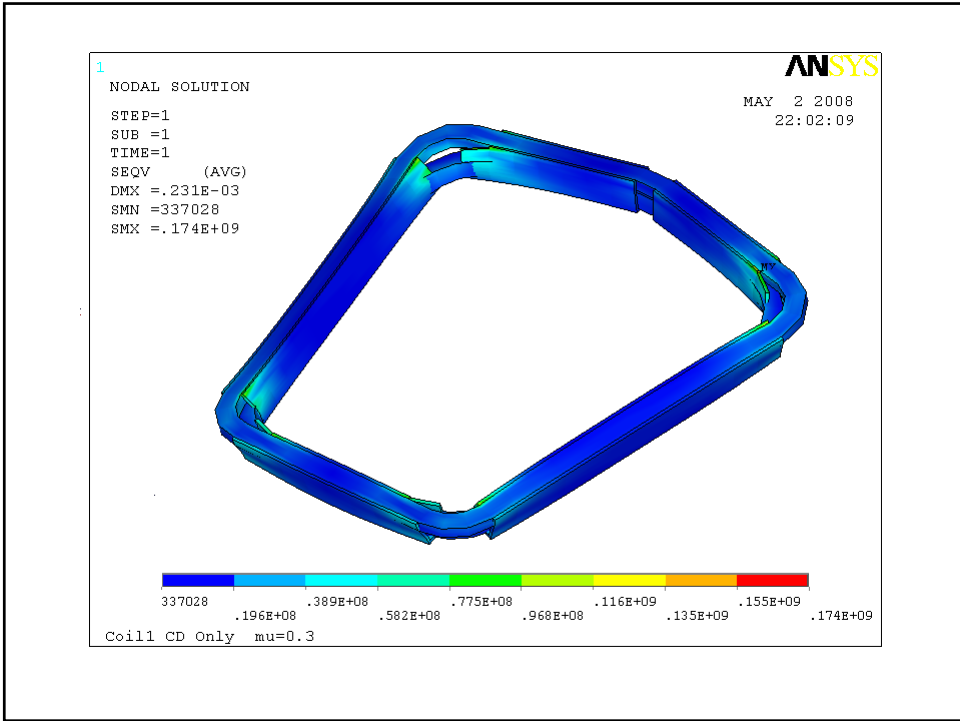

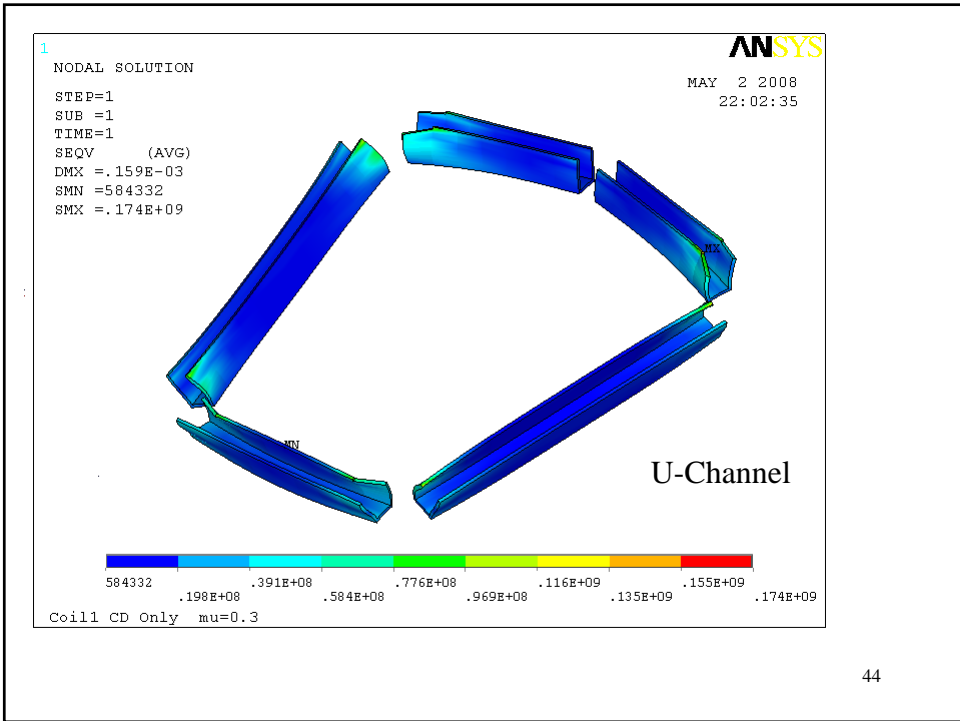
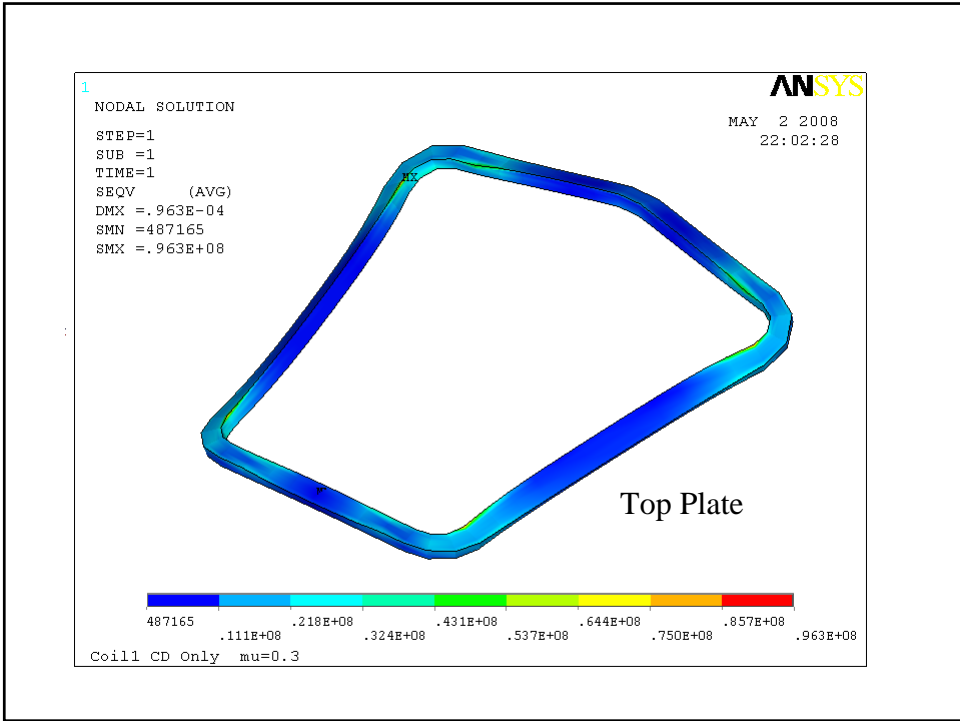

All Coils EM + CD $\mu = 0.3$

45

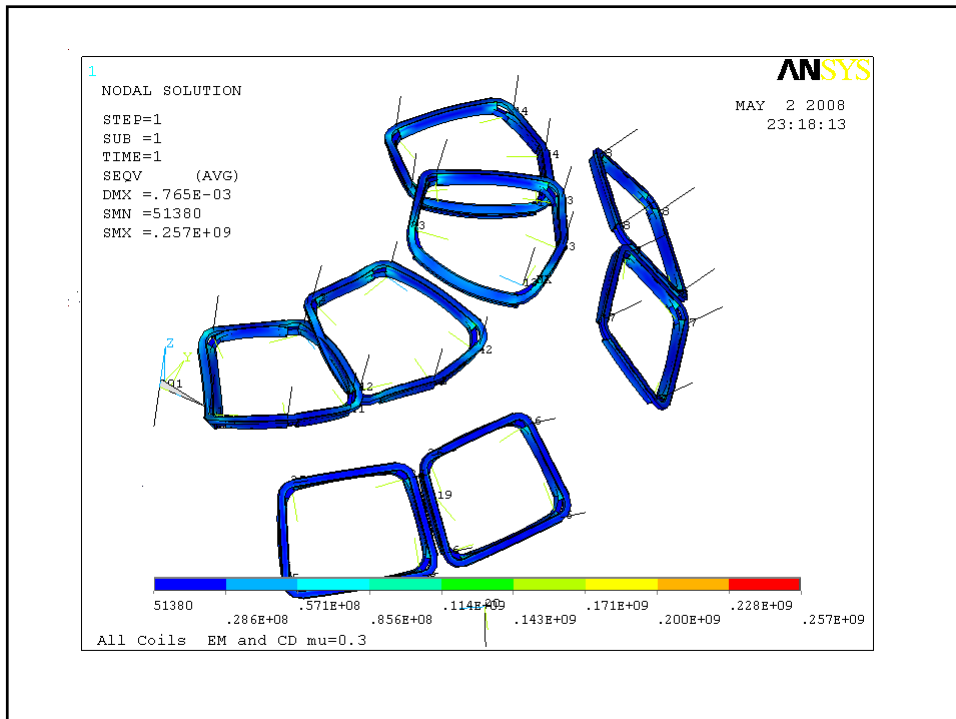

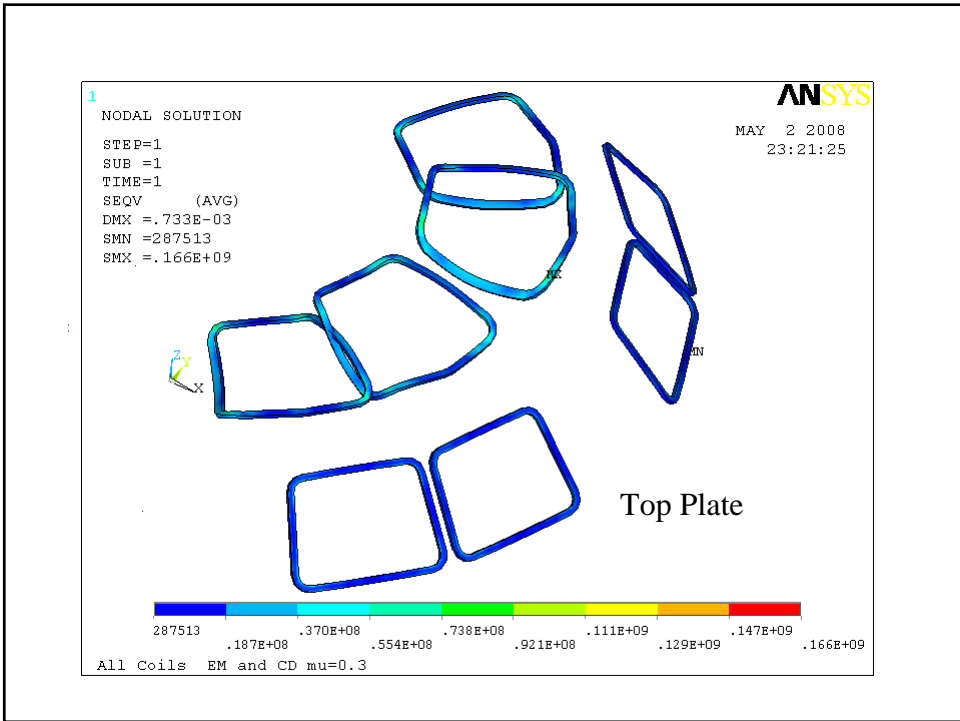
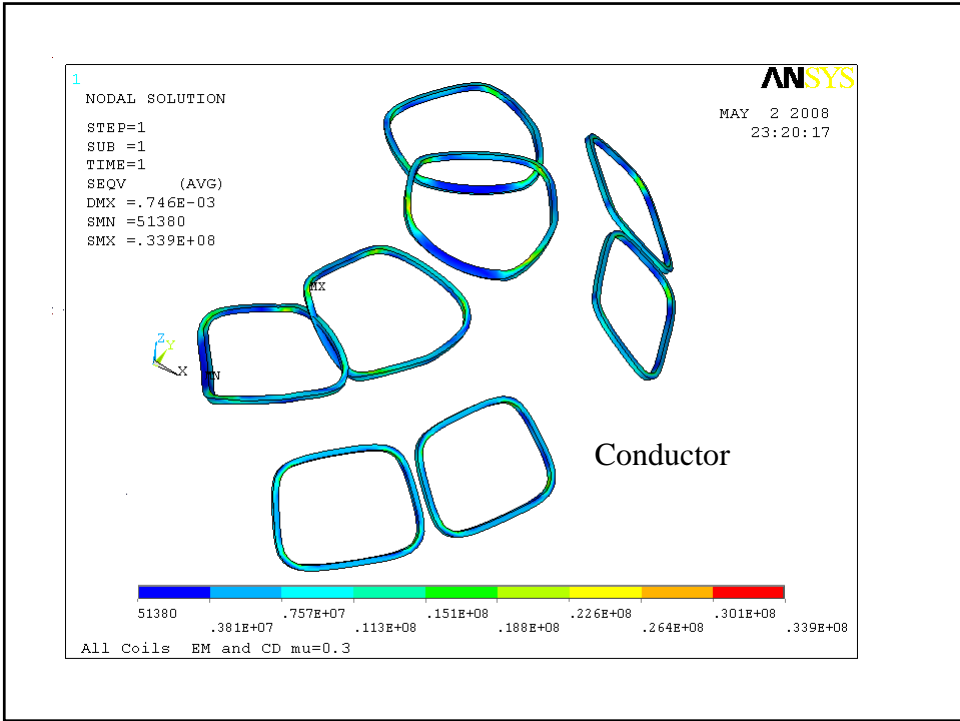

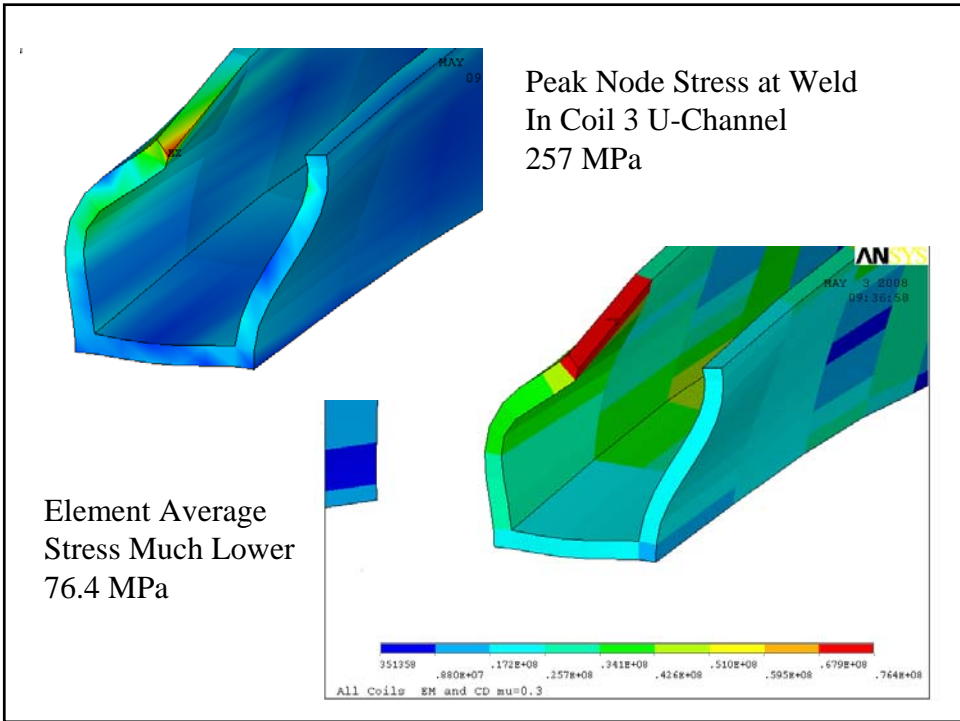
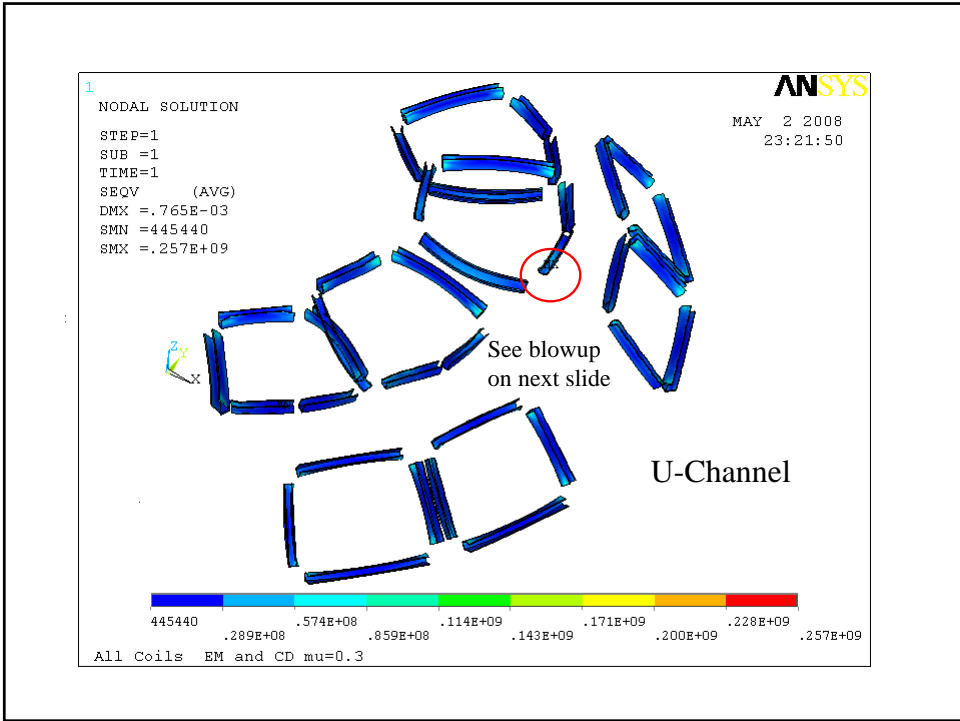

All Coils EM Only $\mu = 0.3$

51

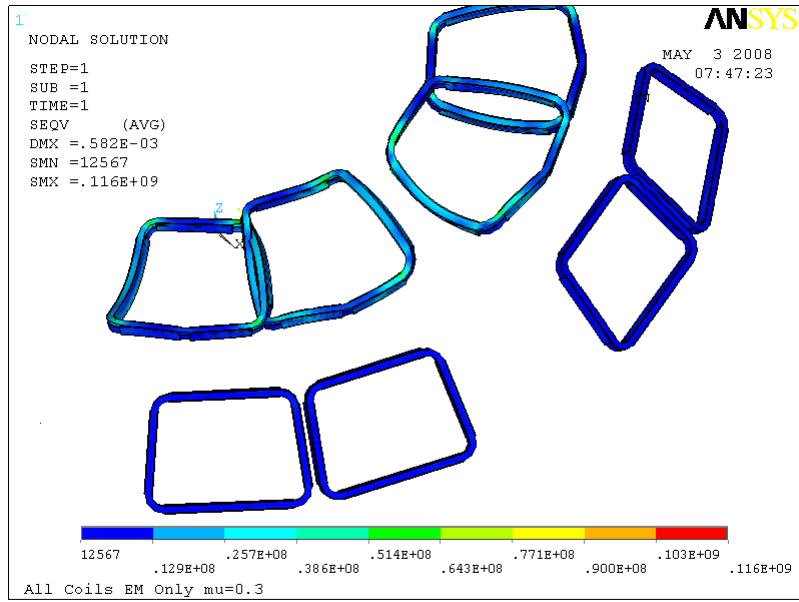

52

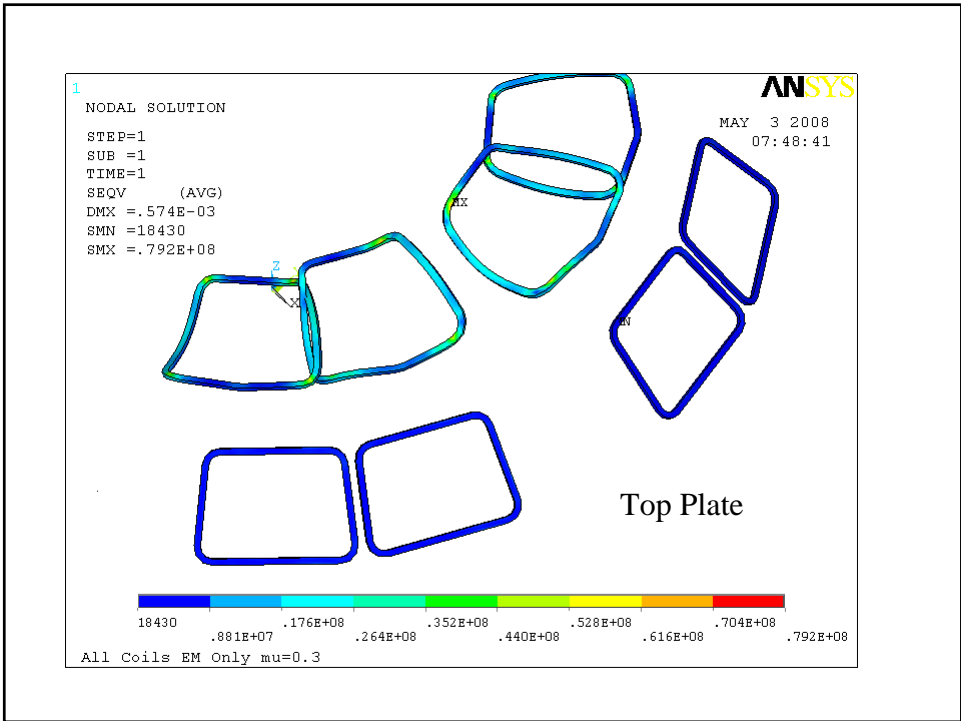
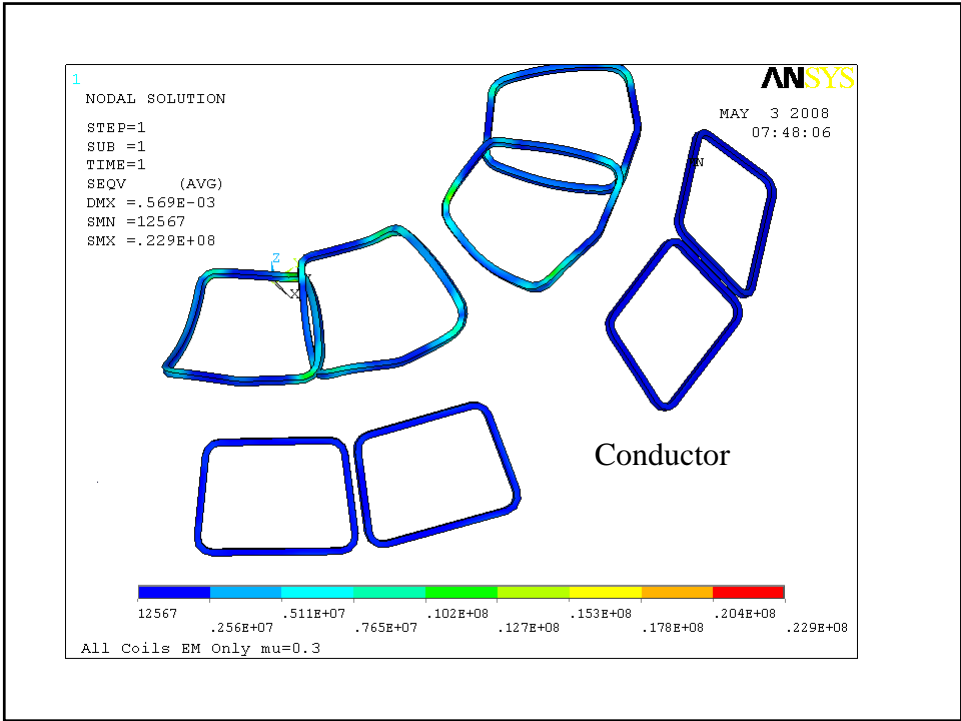

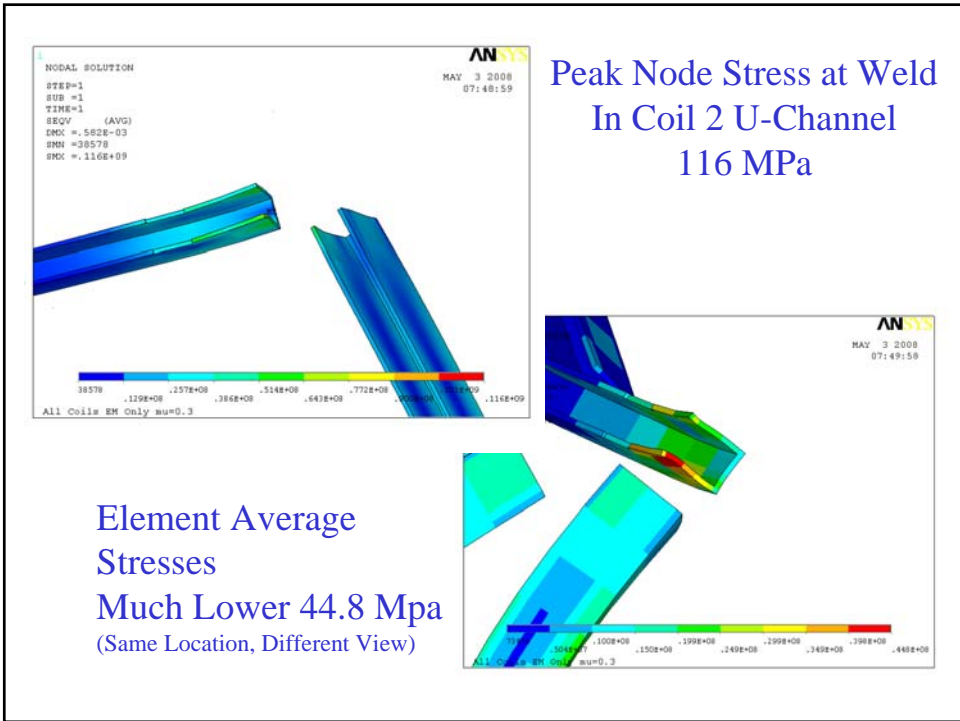
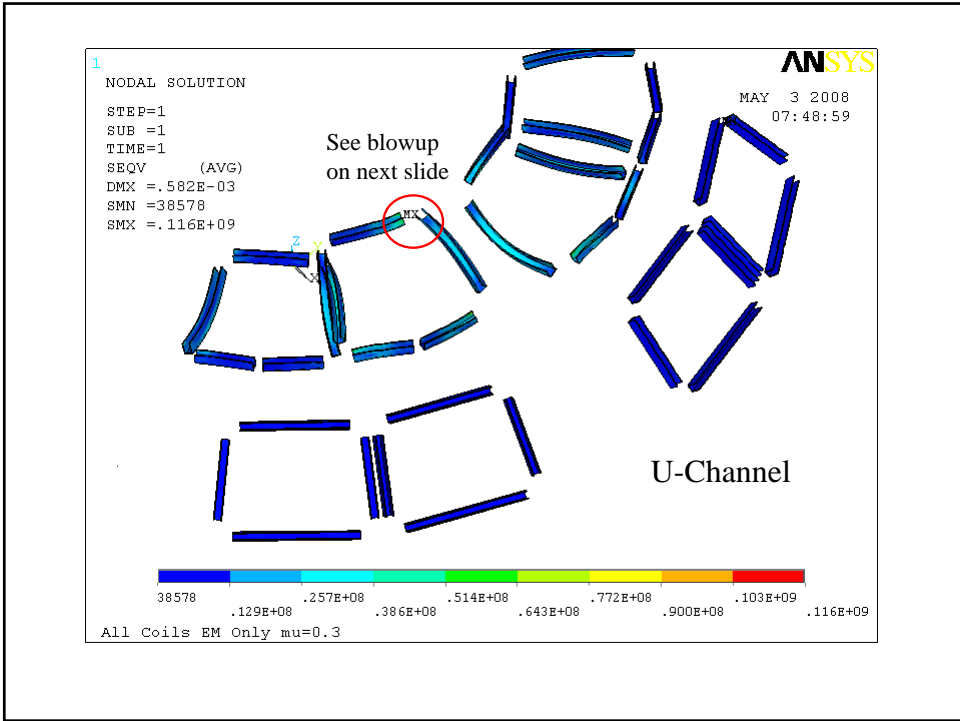

Outboard Coils EM Stresses Much Lower

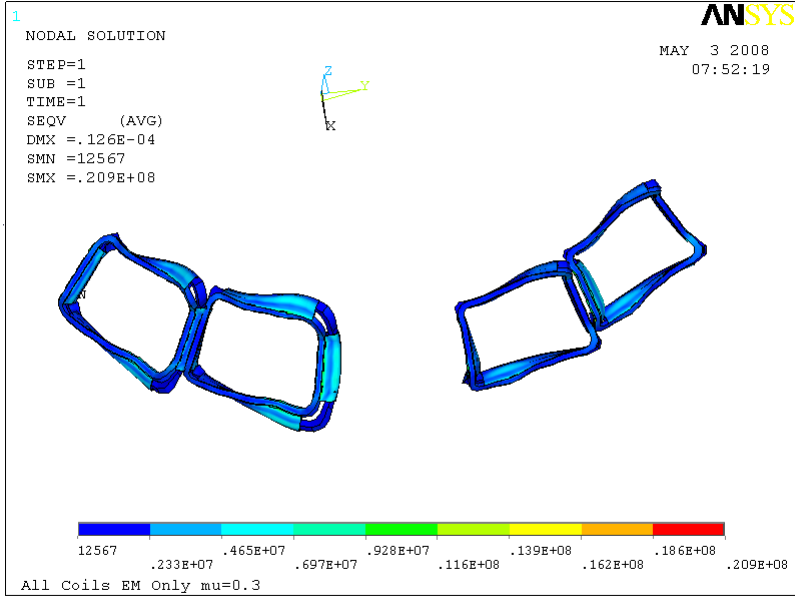

All Coils CD Only $\mu = 0.3$

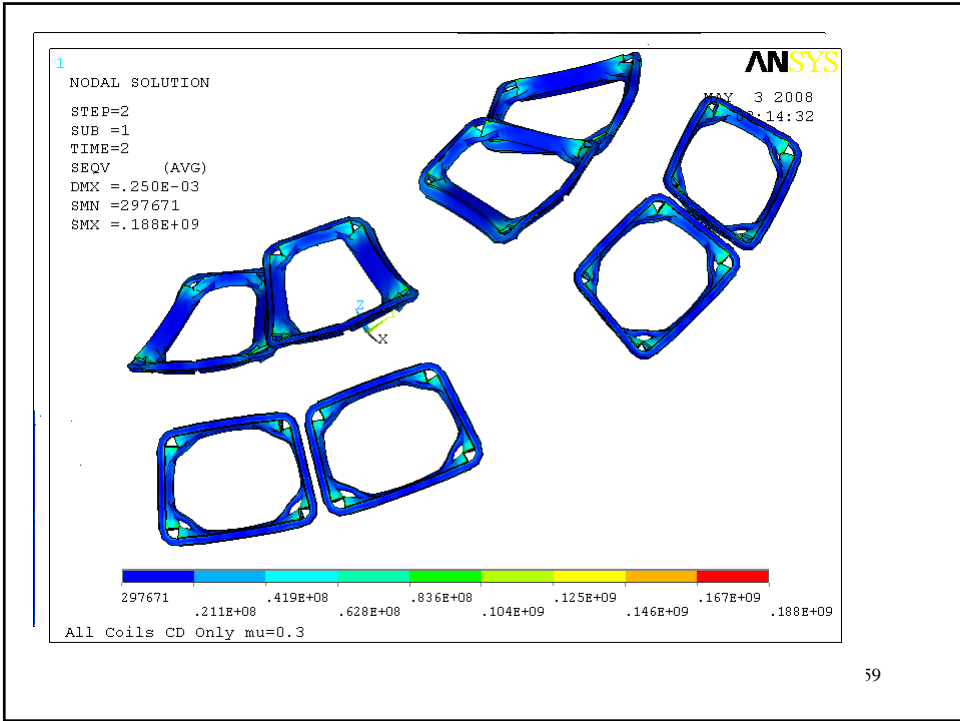

59

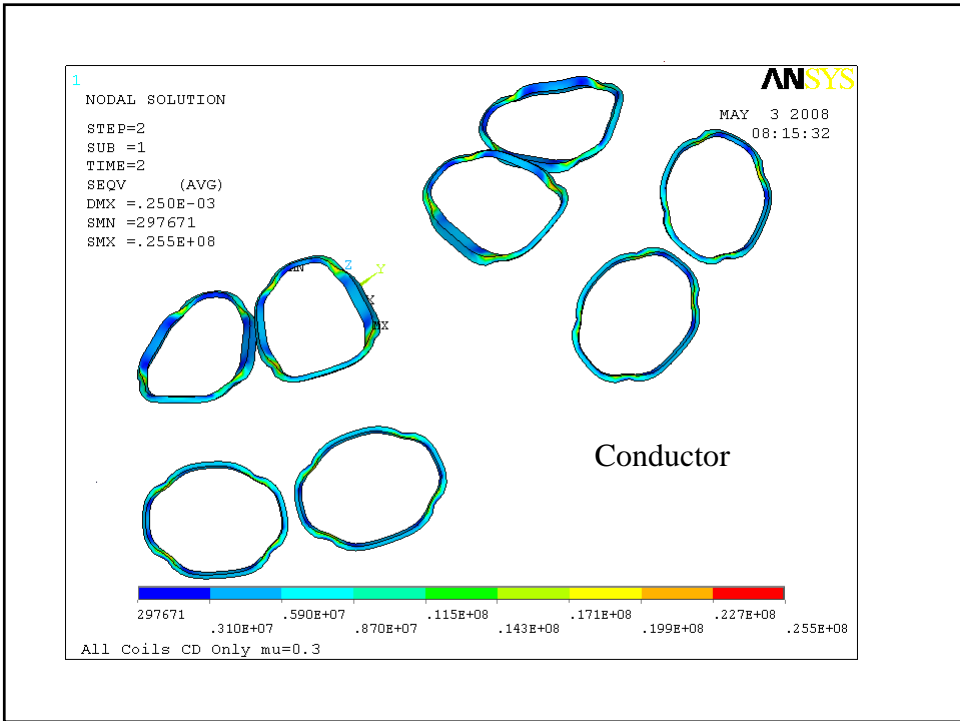

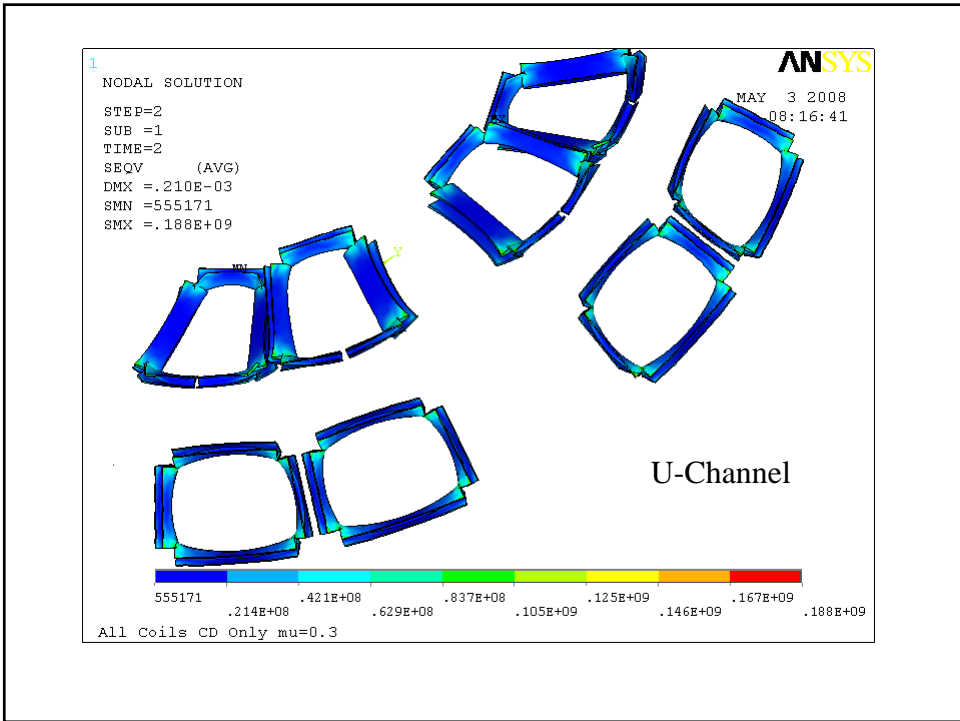
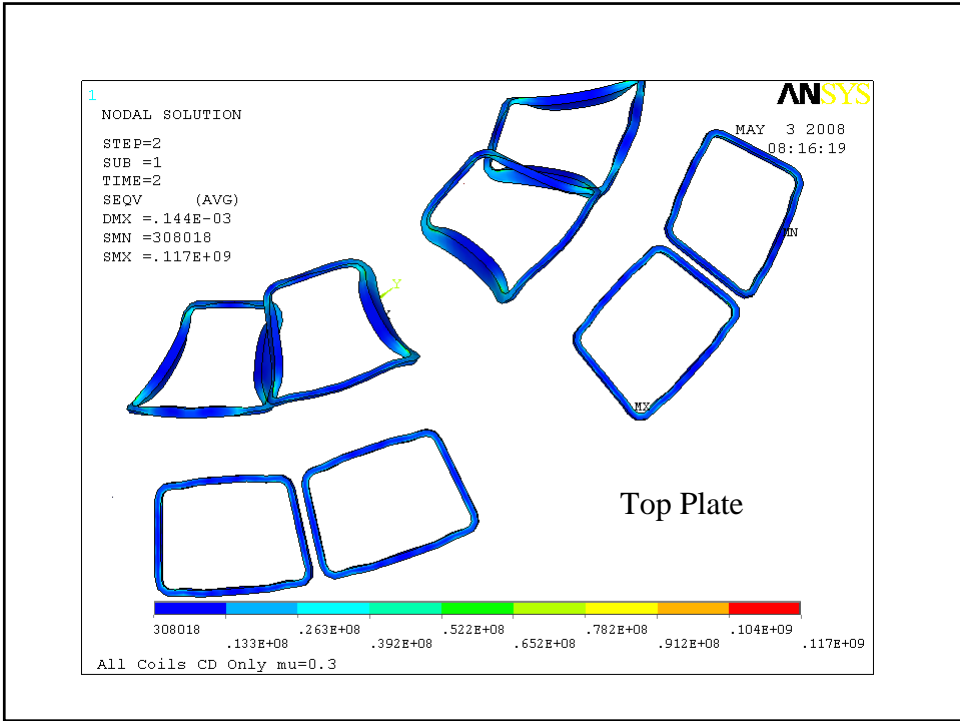

(Node) Stress Summary

		Max Von Mises Stress							
		Cond Composite	Copper	Insulation Plate	U Channel				
No Friction Coil1	mu=0.0 CD+EM	32.5	71.5	8.1	113.0	186.0	Mpa		
		4.6	10.2	1.2	16.1	26.6	ksi		
	EM Only	19.9	43.8	5.0	44.2	34.1	Mpa		
		2.8	6.3	0.7	6.3	4.9	ksi		
	CD Only	25.0	55.0	6.3	106.0	198.0	Mpa		
		3.6	7.9	0.9	15.1	28.3	ksi		
Friction Coil1	mu=0.3 CD+EM	27.4	60.3	6.9	120.0	196.0	Mpa		
		3.9	8.6	1.0	17.1	28.0	ksi		
	EM Only	23.1	50.8	5.8	72.7	54.9	Mpa		
		3.3	7.3	0.8	10.4	7.8	ksi		
	CD Only	24.5	53.9	6.1	96.3	174.0	Mpa		
		3.5	7.7	0.9	13.8	24.9	ksi		
Friction All Coils	mu=0.3 CD+EM	33.9	74.6	8.5	166.0	257.0	Mpa		
		4.8	10.7	1.2	23.7	36.7	ksi		
	EM Only	22.9	50.4	5.7	79.2	116.0	Mpa		
		3.3	7.2	0.8	11.3	16.6	ksi		
	CD Only	25.5	56.1	6.4	117.0	188.0	Mpa		
		3.6	8.0	0.9	16.7	26.9	ksi		

Element Average Stress at Max Location drops from 257 to 76.4 MPa

All Coils EM Only mu = 0.3 0.5 TF

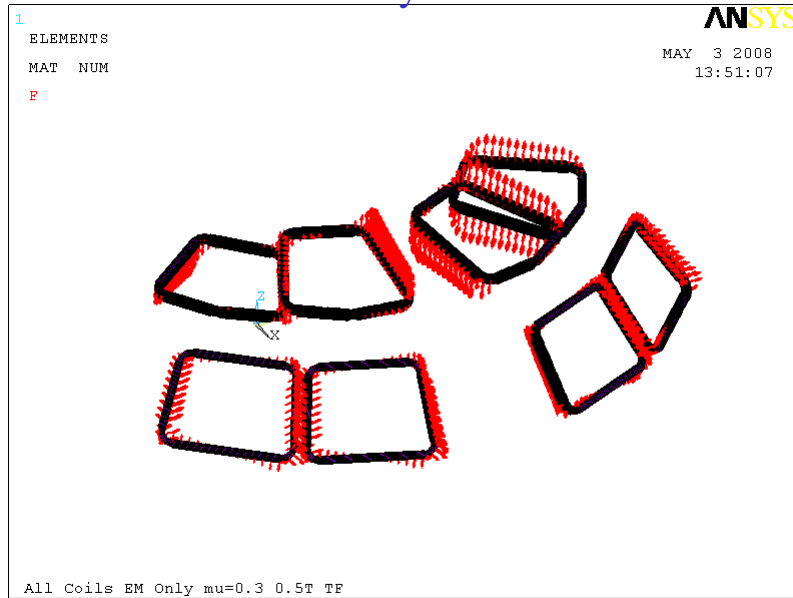

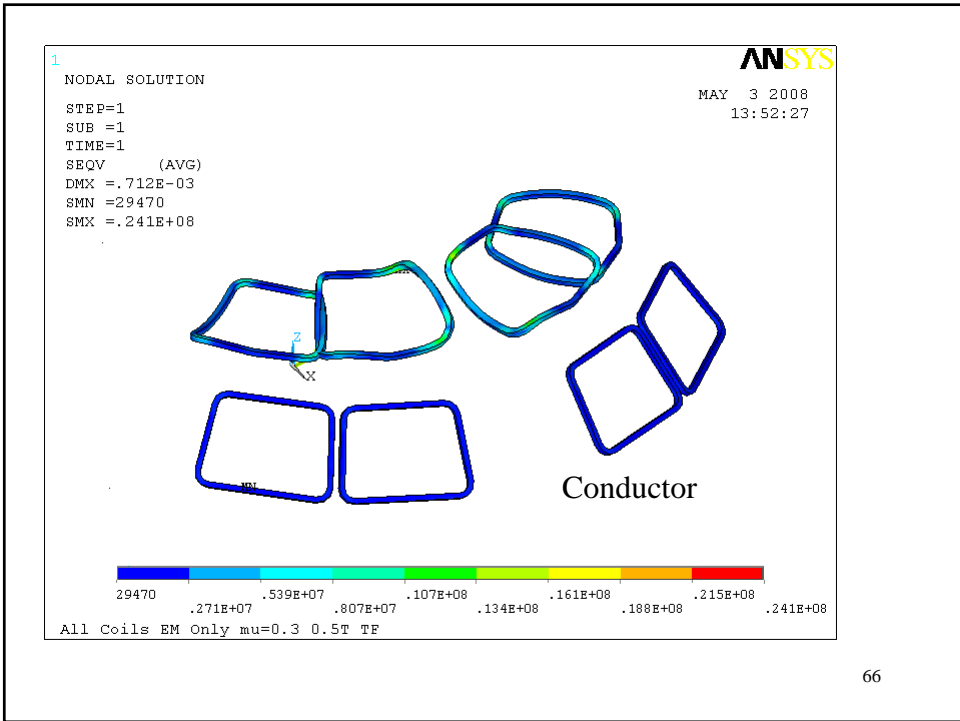
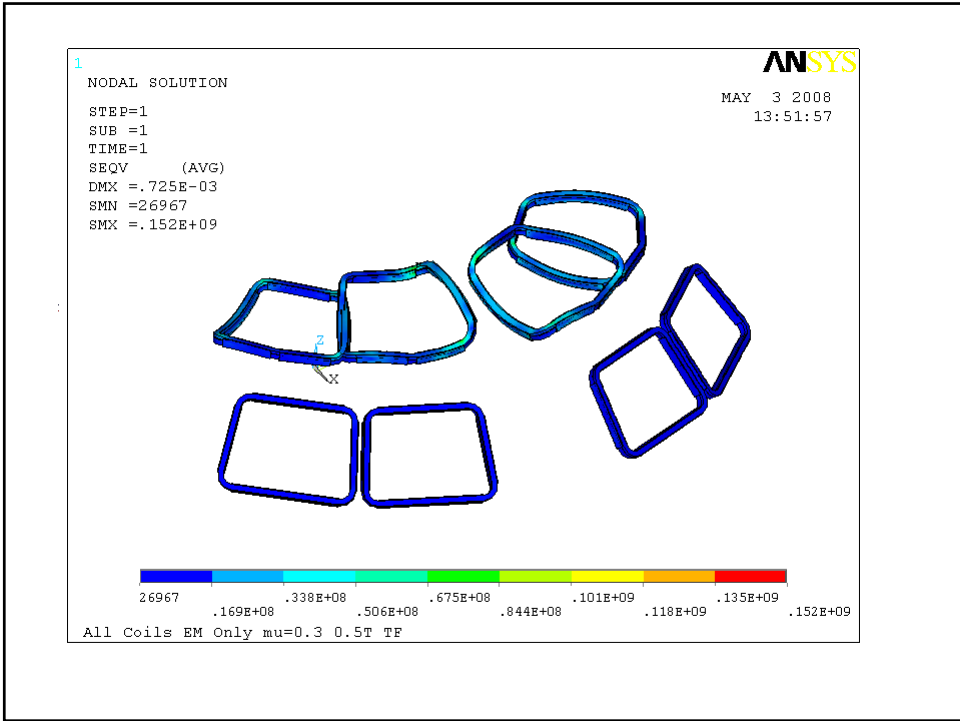

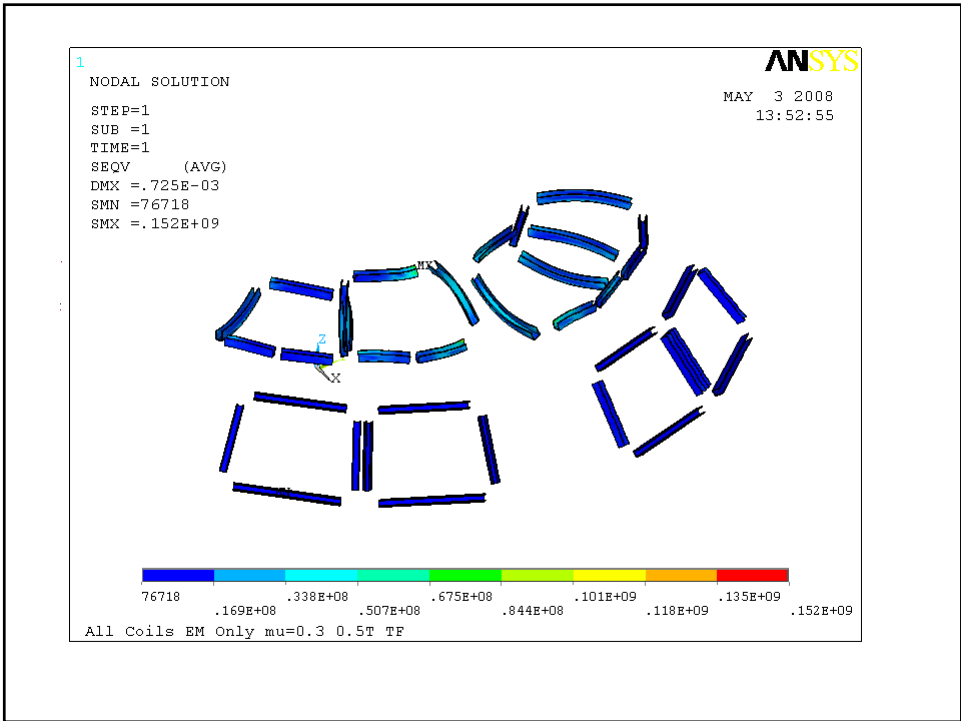
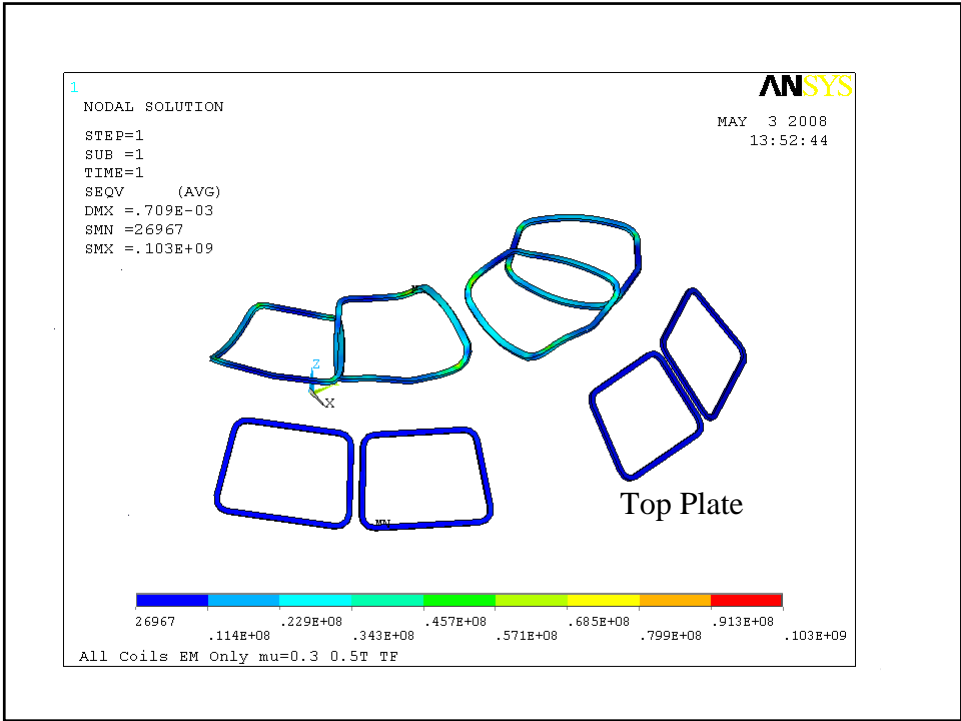

All Coils EM Only $\mu = 0.3$ 2T HB $t=0.197s$

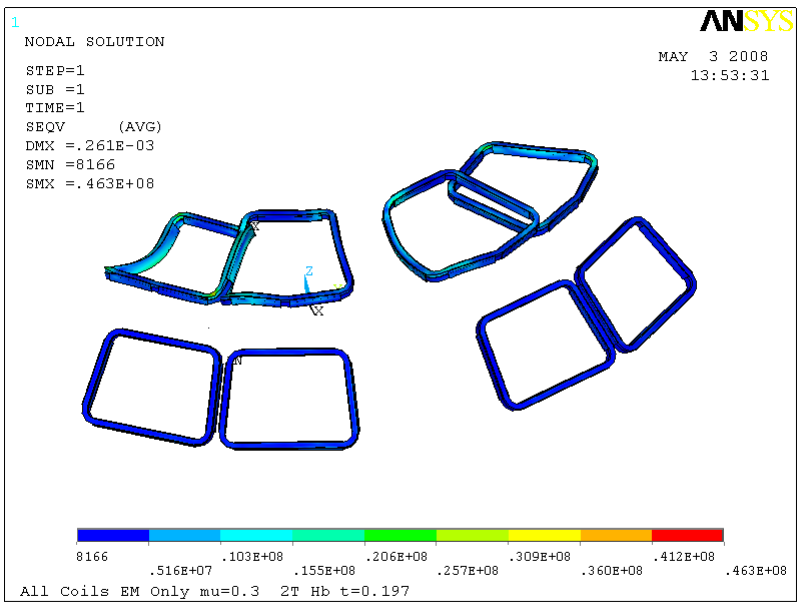
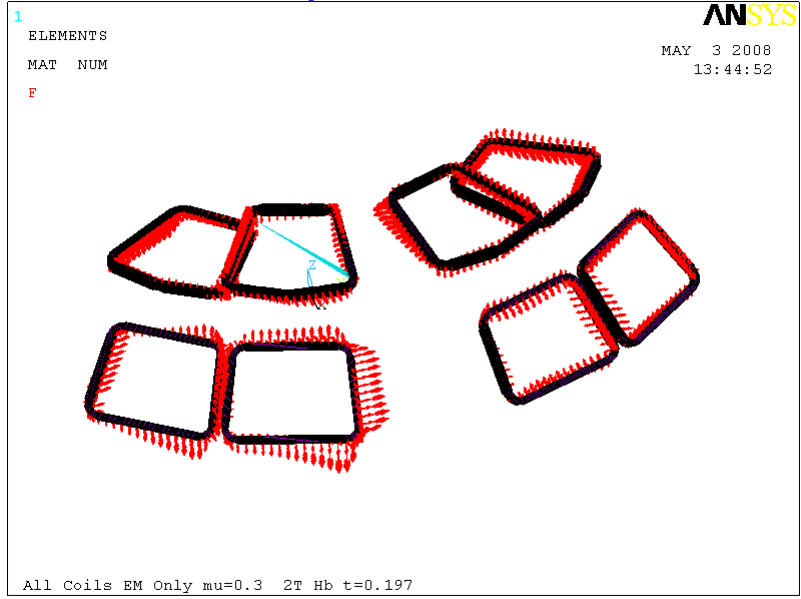

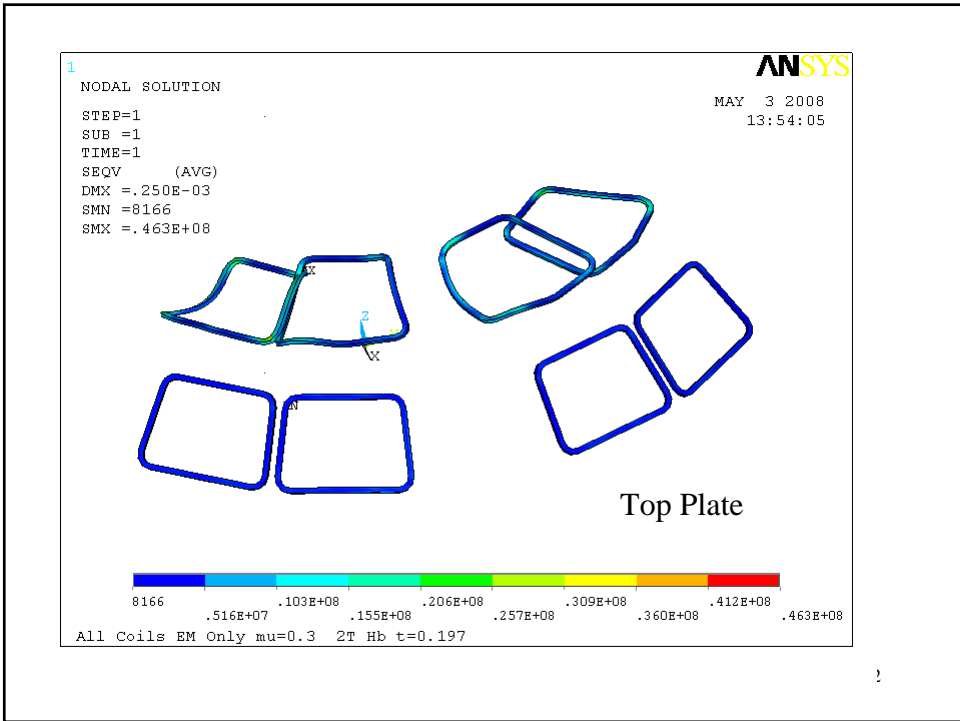
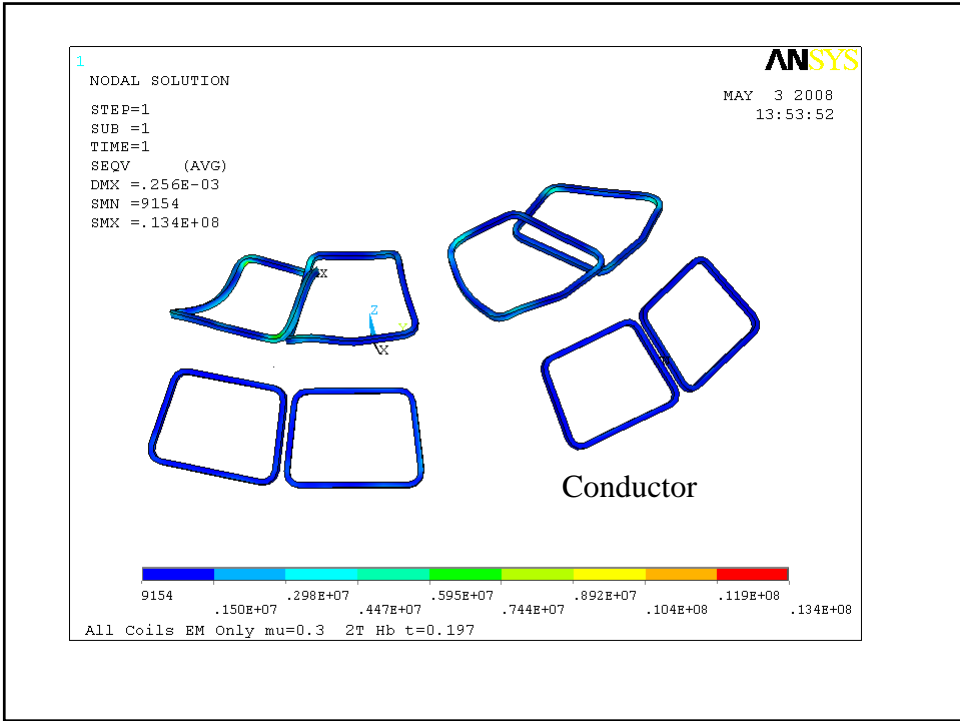

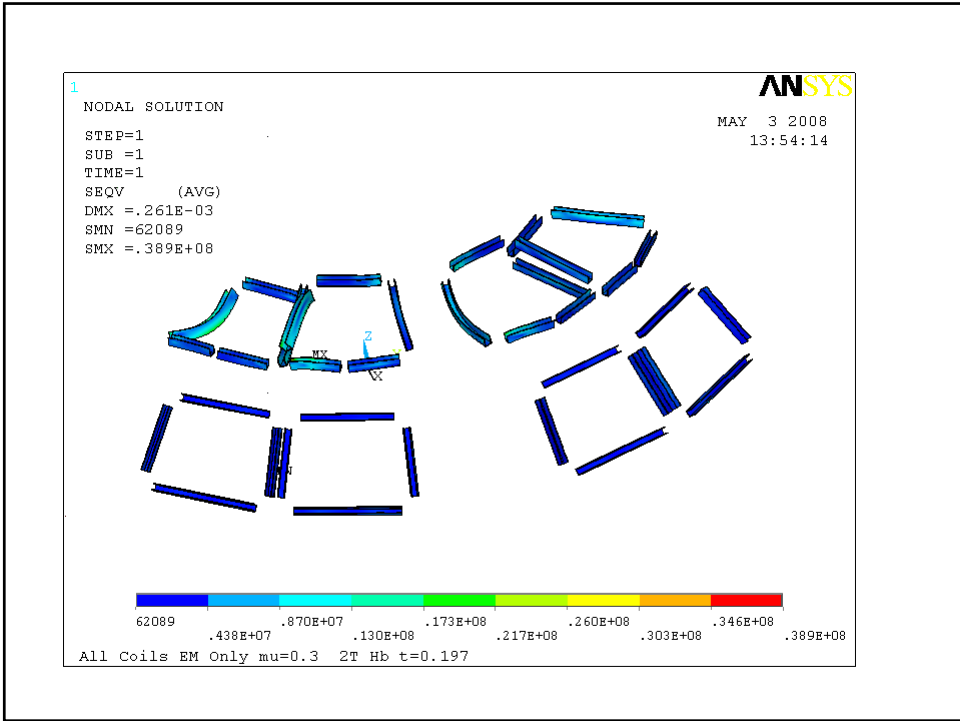

Comparison of EM Scenarios

Friction	mu=0.3 EM Only	Max Von Mises Stress										
		All Coils	Cond Composite	Copper	Insulation Plate	U Channel						
iota=0.19		22.9	3.3	50.4	7.2	5.7	0.8	79.2	11.3	116.0	16.6	Mpa
0.5T TF		24.1	3.4	53.0	7.6	6.0	0.9	103.0	14.7	152.0	21.7	Mpa
2T HB t=0.197s		13.4	1.9	29.5	4.2	3.4	0.5	46.3	6.6	38.9	5.6	Mpa
												ksi