

# NCSX

## Modular Coil Shim Testing

NCSX-CALC-14-004-00

25 Feb 2008

**Prepared by:**

---

KD Freudenberg, ORNL

---

R Battiste, ORNL

*I have reviewed this calculation and, to my professional satisfaction, it is properly performed and correct. I concur with analysis methodology and inputs and with the reasonableness of the results and their interpretation.*

**Reviewed by:**

---

PL Goranson, ORNL

Controlled Document

**THIS IS AN UNCONTROLLED DOCUMENT ONCE PRINTED.**

Check the NCSX Engineering Web prior to use to assure that this document is current.

## **Introduction**

The NCSX Modular Coils (MC) utilize stainless steel shim stock coated with alumina to provide a friction shear connection between the coil flanges. The goal is to prevent slippage between the coil sections during magnetic loading, thus maintaining alignment of the coils. This test program was designed to test the performance of the shims.

## **Objectives**

1. Validate that the "real world" friction shims work as advertised.
2. Determine change in preload of the entire assembly when cooled to 100 K and cycled.
3. Validate FEA models for individual bolt connections.
4. Determine cyclic effects on the overall joint.
5. Pull to failure of friction shim at which point bolt will load up and take shear. (when does this happen)
7. From a practical standpoint, the info should allow us to come up with a re-tightening schedule.

## **Performance Requirements and Criteria**

- A double shear configuration was adopted to prevent potential bending effects entering into the test. The goal was to study the shim performance and it was important to eliminate any interactions which would complicate interpretations of the results.
- The test fixture utilized two tapped joints assembled into the test fixture in a prototypic manner, using all washers, bushings and frictional coatings used in the real assembly.

## **Configuration**

A pull assembly, prototypic of a straight MC flange section, was fabricated to simulate loads in flat regions of the MC coils. The assembly was mounted within a cryogenic containment tank and tested on a MTS test machine located in building 4508. **Figures 1-3** show the test assembly and test section. Deflections of the pull fixture halves and shear bolt ends were monitored during testing by Linear Voltage Displacement Transducer (LVDT) gauges projecting through the tank, in addition to the MTS load train output readings. A liquid nitrogen bath was maintained below the pull fixture to maintain the temperature at 100 K, but not "wet" the assembly.

- Max loading on machine in current configuration with load cell, grips, and spherical bearings was 50 Kips, a maximum load of 25,000 lbs/joint in double shear.

- The machine maximum loading capability was 110 Kips.

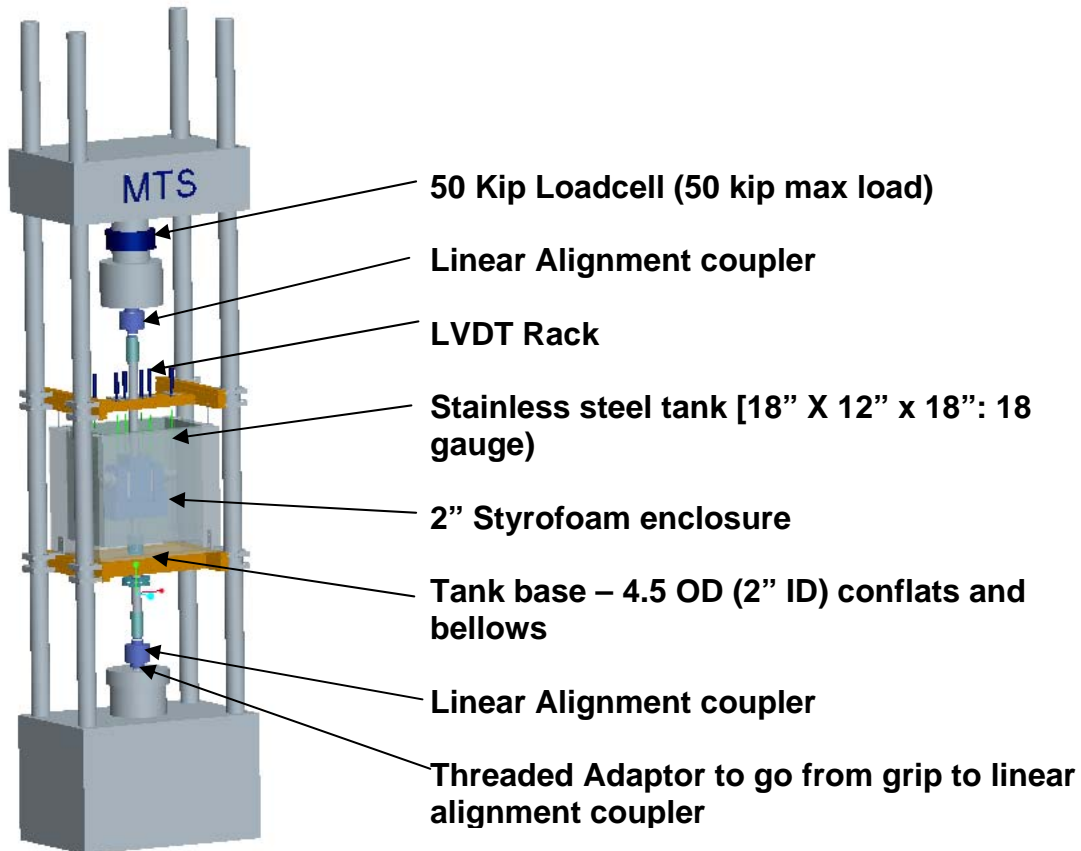

**Figure 1.** Test setup using 4-post MTS testing machine in 4508

### Test Procedure

#### Case 1:

A preload of 35 ft-lbs of torque shall be placed the jack screws (70,000 lbs to 76,000 lbs compression on the joint) using the Super Nuts and the manufacturer's recommended torque procedure.

#### Static Testing

The pull fixture shall be installed on the MTS machine and a minimum of 2 pull cycles shall be performed in the following manner:

- The tension load shall be ramped from zero up to 50,000 lbs at a load rate of approximately 50 pounds per second.
- The load shall be held at 50,000 lbs until steady state is confirmed.
- The load shall then be ramped down to zero load at the same rate as it was loaded.

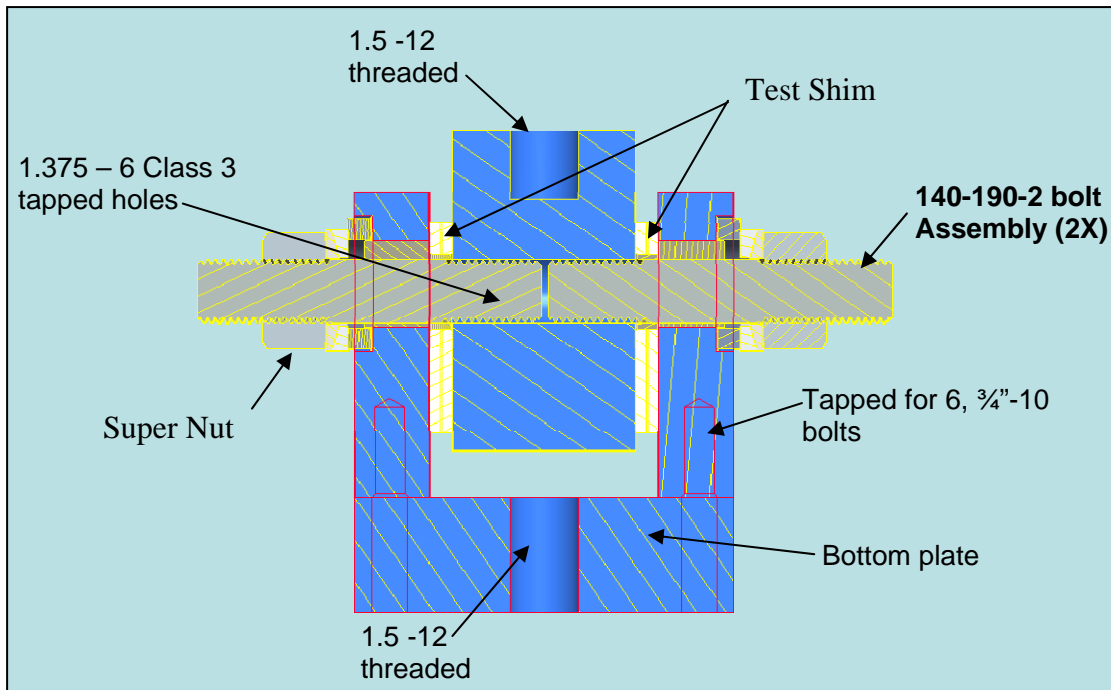

**Figure 2.** Layout of Pull Fixture

#### Cyclic testing

Provided that there is apparent damage or slippage in the previous testing, the joint shall be cycled at the fastest rate practical, as determined during the testing. The tension load shall cycle between 500 and 50,000 lbs for 100,000 cycles or until failure occurs, whichever comes first. In the event there is unusual performance or visible damage to the assembly, the testing shall be terminated and the damage evaluated by Engineering before further testing is performed.

#### Case 2.

After completion of the Case 1 testing the pull fixture shall be removed from the MTS machine, the shims inspected, and the jackscrew tension shall be checked to determine whether there has been a loss of preload. The preload on the jackscrews shall then be reduced to 10 ft-lbs of torque (22,700 lbs to 25,000 lbs compression on the joint) for the Case 2 testing.

**Note: Unloading of the Super Nut jackscrews must be performed per the manufacturer's recommended unloading procedure to prevent damage to the jackscrews.**

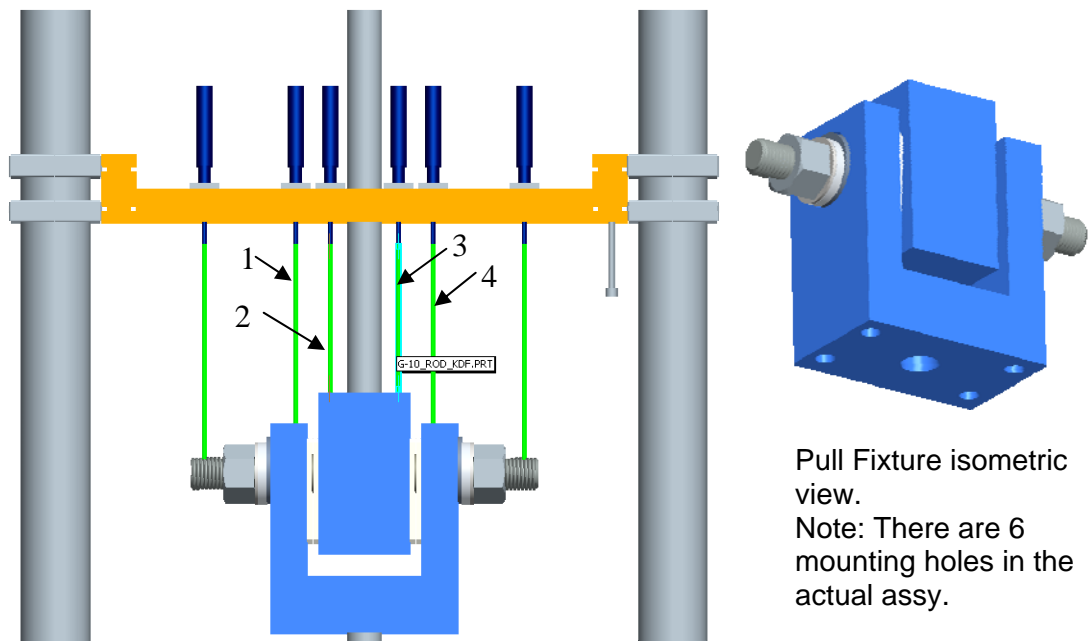

**Figure 3.** Locations of recorded LVDT readings

#### Static testing

The pull fixture shall be reinstalled in the MTS machine and a pull cycle shall be performed in the following manner:

- The tension load shall be ramped up, from zero load, at a load rate of approximately 50 pounds per second and shall be monitored to determine when the shim indicates slippage.
- The testing shall be terminated when there is clear indication of slippage or off-normal motion.
- In the event there is no slippage, the loading shall proceed up to 50,000 lbs and shall be held at that level until steady state is confirmed.
- The load shall then be ramped down to zero load at the same rate as it was loaded.

After completion of the Case 2 testing, the pull fixture shall be removed from the MTS machine, disassembled, and the shims inspected for damage or wear marks.

### Test Results

#### Case 1

#### Static testing

- The torque wrench used to preload the jackscrews had a tolerance of  $\pm 4$  percent.

- The Super Nuts have a tolerance of  $\pm 10$  percent.
- A period of about 4 weeks transpired between the torque of the jackscrews and actual performance of the first pull test.
- During cool down the unit reached a steady state temperature of 100 K in approximately 3 hours. The gradient between the top and bottom of the fixture was approximately 7-10 degrees K.
- Approximately 200 additional cycles between 0 and 50,000 lbs were performed on the fixture, after the static testing was complete and while it was still chilled. During this testing the optimal cyclic rate for the fixture and MTS machine combination was determine to be 4 HZ.

The loading to 50,000 lbs proceeded without incident and indicated no slippage in the shims. The second cycle was identical to the first. See **Figure 4 and 5** for the load curves.

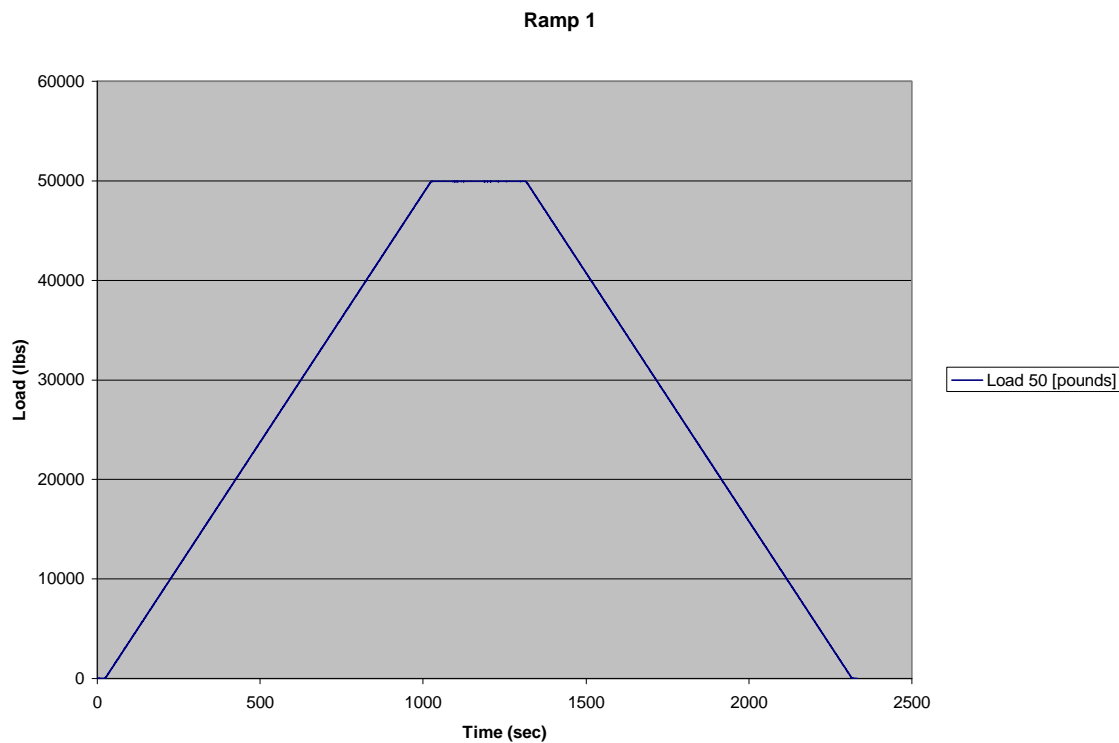

**Figure 4** Ramp loading of unit.

The LVDT readouts tracked with each other and confirmed that there was no relative motion between the assembly yokes. At times the LVDT readouts became highly nonlinear but this was shown to coincide with the LN2 supply valve opening, resulting in increased nitrogen flow around the probe G10 extension rods and sudden contraction in

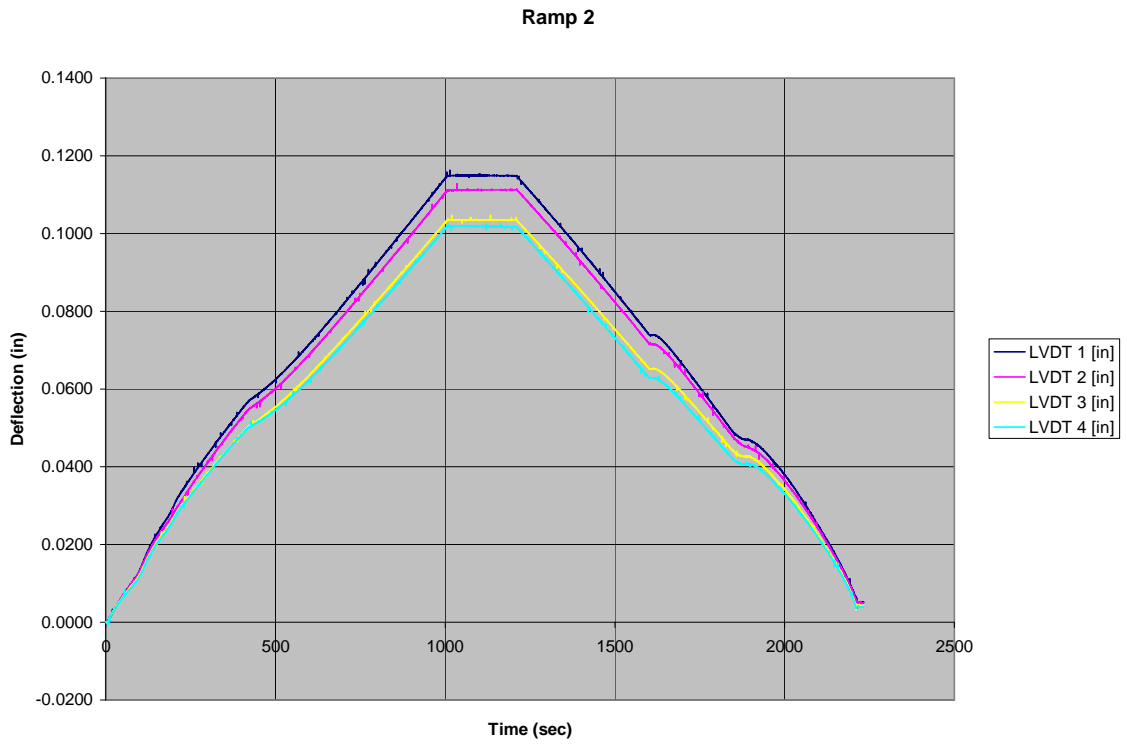
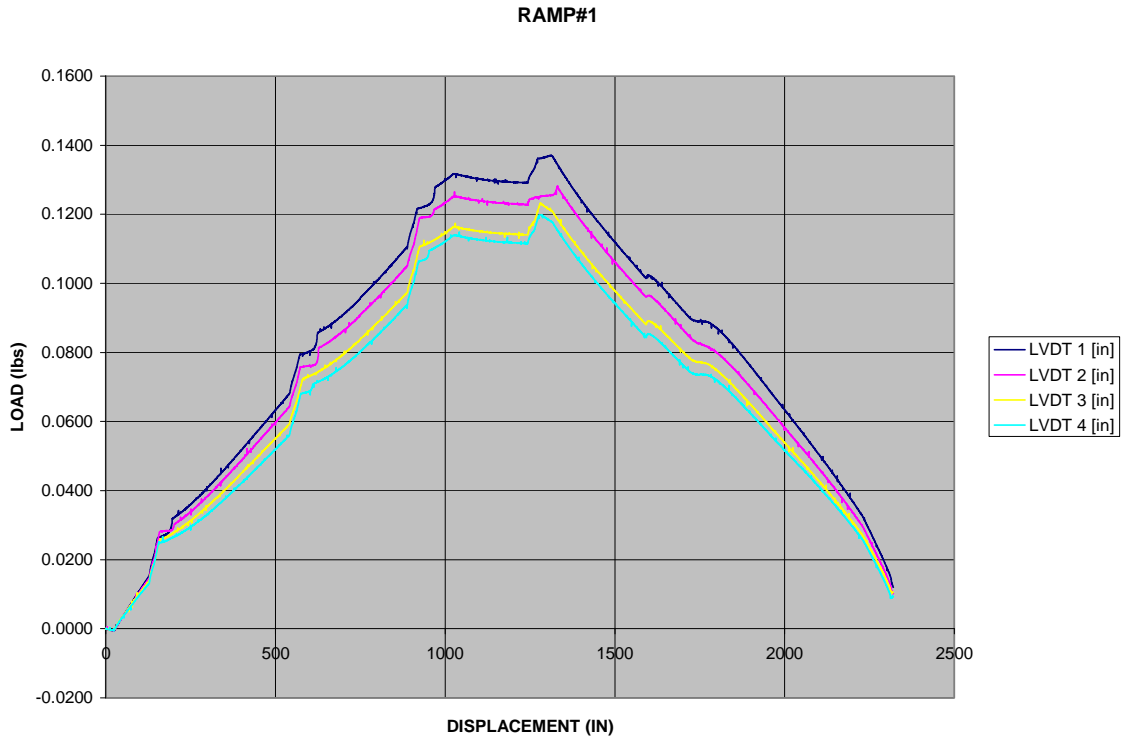

**Figure 5** LVDT deflections during ramp testing.

their length. This problem could be minimized by exchanging the rods with a lower expansion coefficient material. The effect was partially mitigated in the second ramp test by permitting a constant flow of cryogenic gas to flow through the system, decreasing the rod temperature transients.

#### Cyclic testing

- The unit was returned to room temperature and re-chilled between the static and cyclic testing.

A series of 10,000 cycles were performed at 1 HZ with no apparent slippage. The LVDT readouts did not track with the cycling. The cause was an incorrect terminal hookup and was corrected on the next set of higher frequency cycling tests.

The testing proceeded at 4 HZ, with no slippage for 60,000 cycles, at which time the testing was halted and the unit was brought back up to room temperature. The LVDT readouts successfully tracked with the cycling. See **Figures 6 and 7** for the load curves.

The unit was re-chilled and testing proceeded for an additional 24,000 cycles, a total of over 94,000 cycles on the unit. Cyclic testing was terminated at this point due to structural failure of the MTS machine.

The unit was dismantled and removed from the MTS machine for inspection and preparation for Case 2 testing. During this procedure the jackscrew torque was rechecked and found to be higher than 32 ft-lbs and slightly less than 35 ft-lbs, indicating there was little or no loss of preload. Repair of the MTS took several weeks and the delay made the schedule critical; therefore, a decision was made not to continue with cycling testing, as 94,000 cycles was close enough to the test plan to meet the goals.

The shims were undamaged but did indicate some wear, with a somewhat frosted appearance in a ‘quilted’ pattern that was not there initially. Under 10 power magnification this pattern seemed to be concentrated on the high points on the alumina

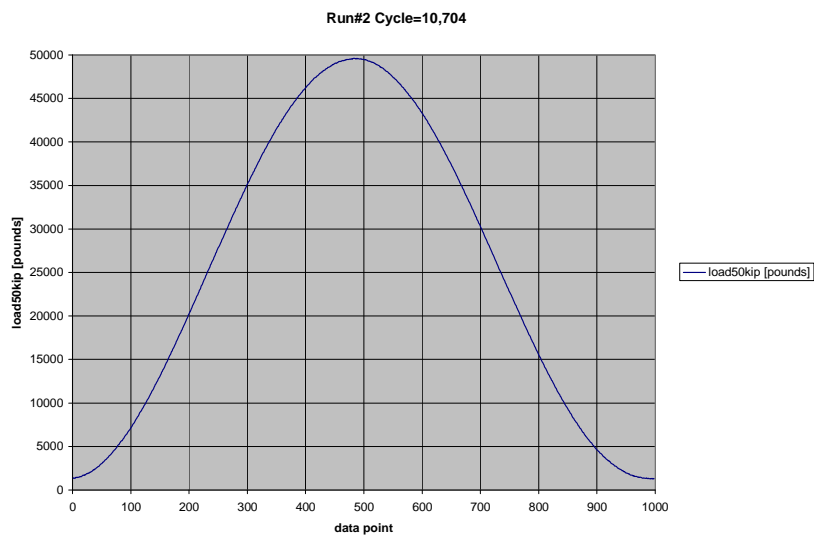

**Figure 6.** Typical cycle showing load train readout.



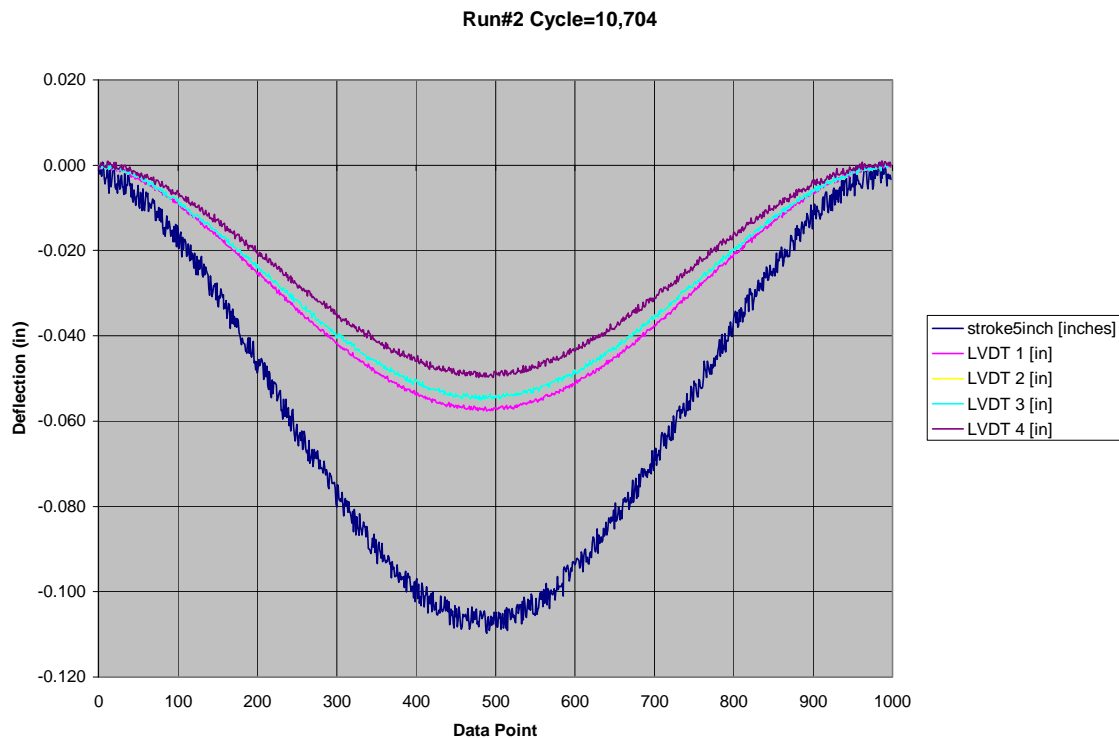

**Figure 7.** Typical LVDT readout during cycling run. Bottom trace is global motion of load train.

surface. Fine white alumina powder was evident on the matching stainless surfaces. See the photographs in the appendix. The as-coated surface was not perfectly smooth to begin with and showed a rather dimpled or “orange peel” appearance under magnification.

After repair of the MTS machine, the unit was reassembled and the preload on the jackscrews set at a torque of 10 ft-lbs.

## Case 2

### Static testing

The unit was tension loaded at the rate of 50 lbs per second, starting at zero load, and the load train monitored for signs of slippage.

The joint showed a sudden slippage at 26,700 lbs and continued to load to 50,000 lbs with four more slippage events. The first event correlates to a coefficient of friction of 0.59 with an uncertainty of  $\sim\pm 0.9$ . It was not possible to determine if one side broke free before the other or if subsequent events were the same side or the opposite side of the joint releasing, nevertheless, the results do give a minimum value for the joint friction and it is in close agreement with other testing at PPPL.<sup>1</sup> **Figures 8 and 9** show the load curves for the test. Note the close agreement of the LVDT readout with the load train readout at the slip point. The LVDT readouts show a non-linearity at  $\sim 21000$  lbs but there

is no relative motion, therefore, no slippage has occurred between the halves of the assembly. The perturbation is probably a thermal effect due to a change in gas flow.

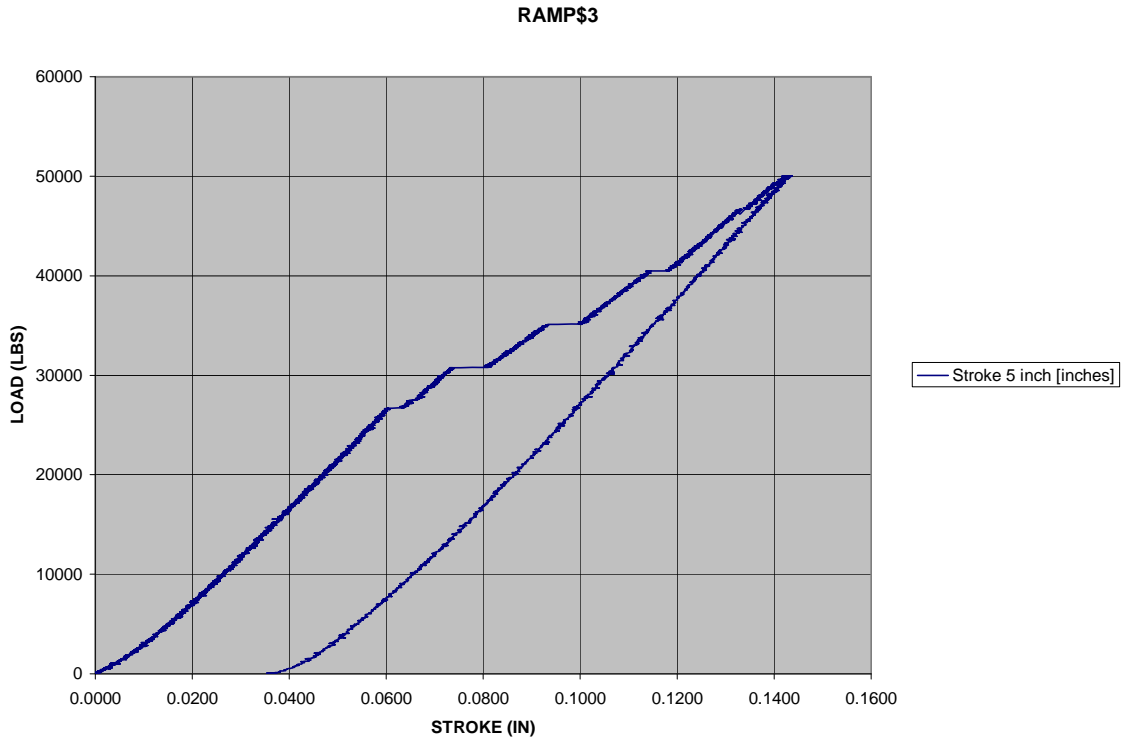

**Figure 8.** Load train readout showing slippage during the loading.

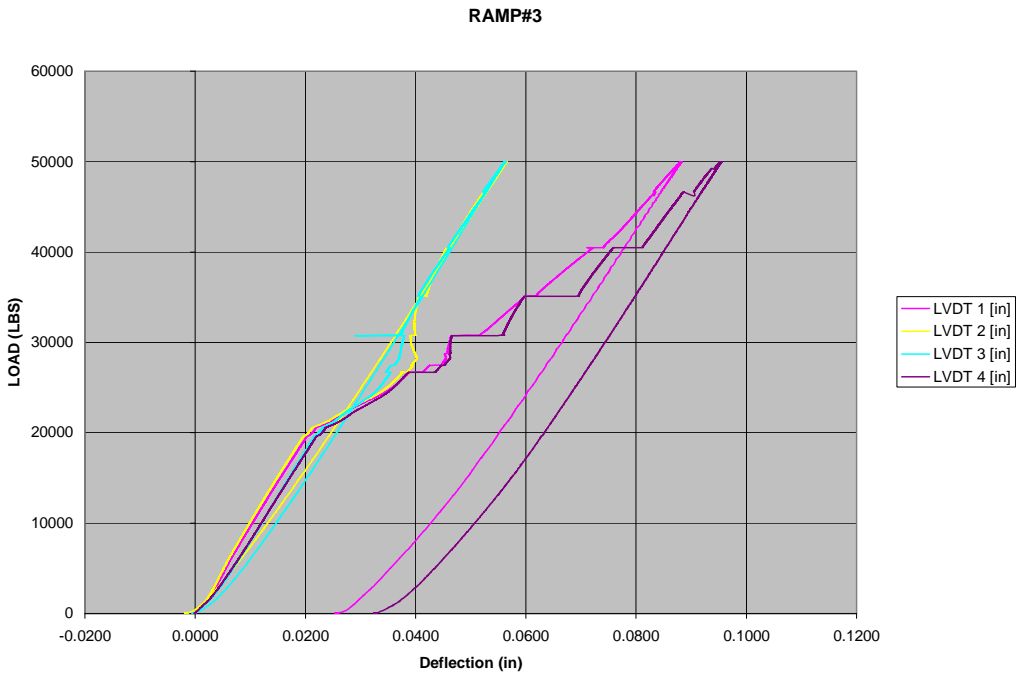

**Figure 9.** LVDT readout showing slippage during the loading.

After completion of testing the unit was disassembled and the shims inspected for damage. The only change from the inspection after cycle testing was the presence of stainless steel transferred onto the alumina. The slippage appeared to have sheared off material from the stainless surfaces, leaving a visible pattern of pits and scratches in distinct horizontal stripes (at least 4) on the stainless. A matching pattern was evident on the mating shim surface and the pattern was approximately the same on both sides of the assembly, indicating both shims had slipped during loading.

There was considerable dishing of the 0.45” thick thrust washers under the jackscrews and imprints of the jackscrews in the surface, indicating that the material needs to be hardened in the production version of the joint. It is remarkable that no loss of preload was discerned.

### **Conclusion**

- The shear joint performed with no slippage for 94,000 cycles under a tension load of 25,000 lbs per joint and a preload of 70,000 lbs compression on each shim.
- No appreciable loss of preload was evident even after weeks of testing and three excursions from room temperature to cryogenic temperature and back again.
- The slight loss off the alumina surface is probably due to a combination of the stress concentration on the high points of the surfaces and the differential movement during cooling and heating, not slippage during testing, as the data indicated no such events. The alumina may benefit from a smoother (ground) surface to reduce the local stressing of the coating. This would probably change the friction coefficient, however.
- The coefficient of friction for the joint at LN2 temperature is  $0.59 \pm 9$ .
- The material used in the thrust washers is inadequate and must be upgraded.

## APPENDIX



Outer trunnion showing powder after completion of testing.

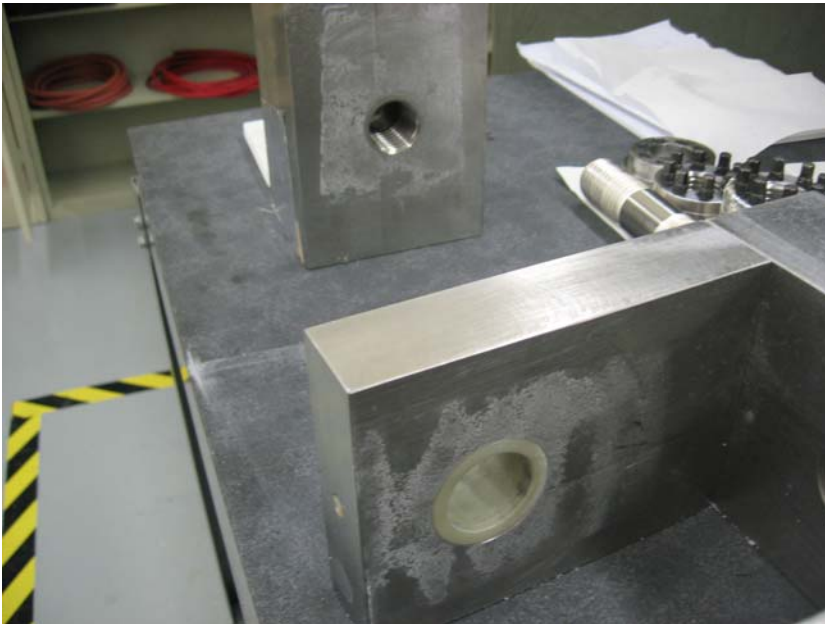

Other half of trunnion.

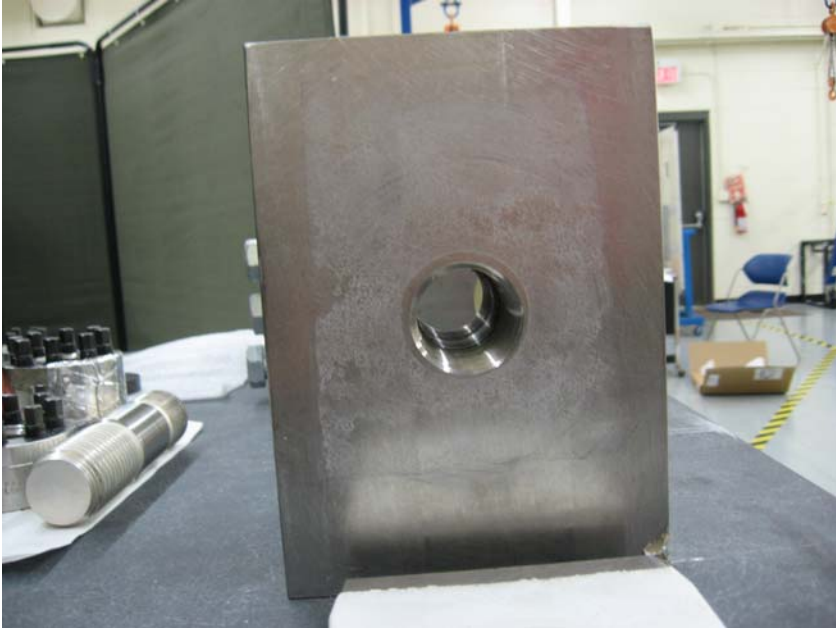

Center trunion showing powder after completion of testing.



Other side of trunion.

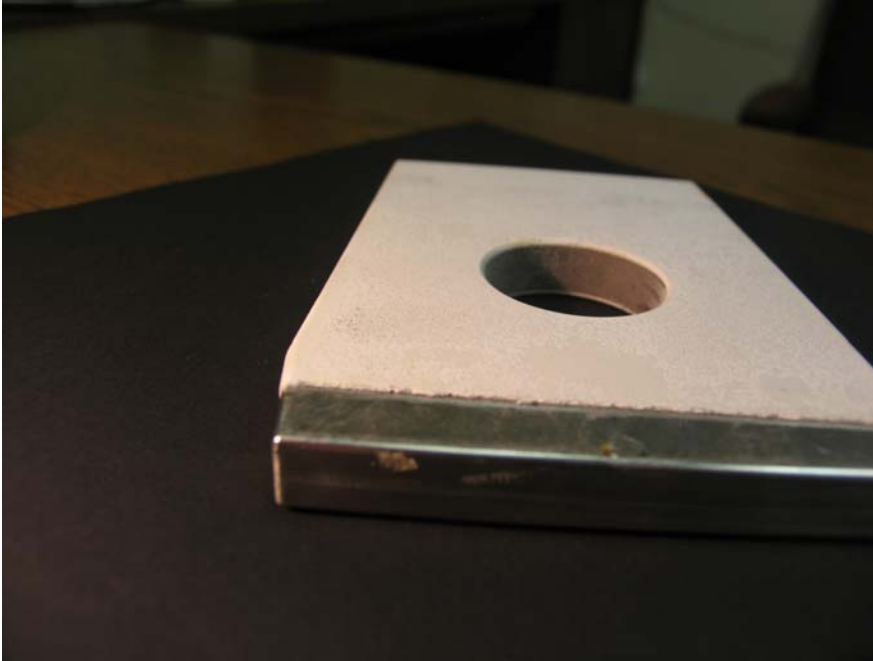

Shim after cycling test, showing “quilted” pattern on alumina.

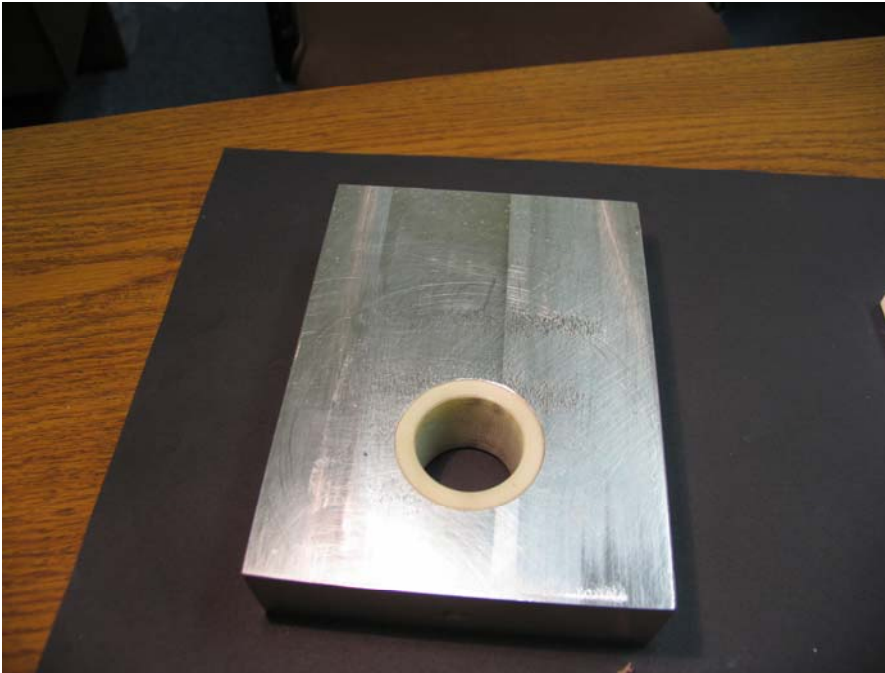

Outer trunnion showing scratch pattern after testing was completed.

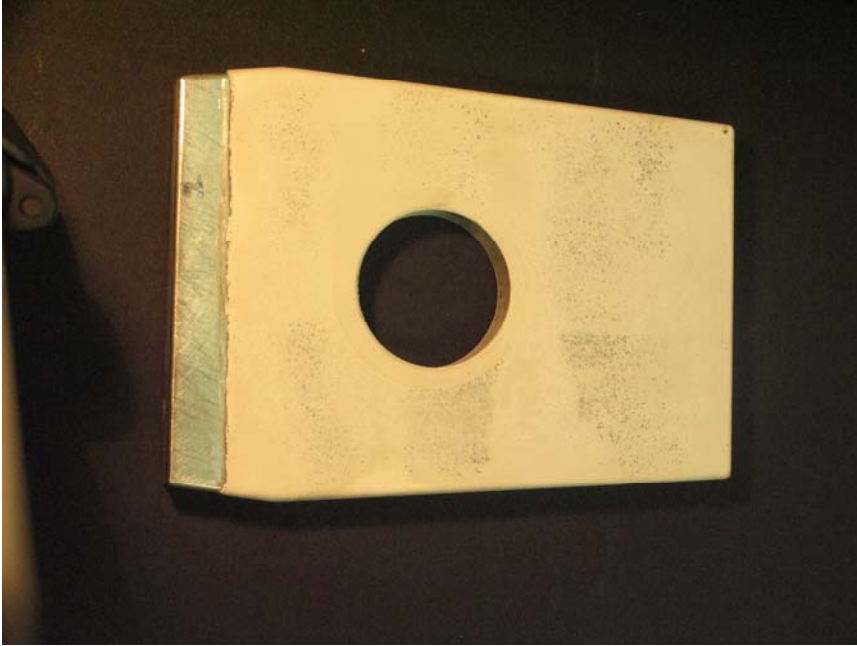

Stainless material on shim after testing was completed.