

NOTES

- 1. DRAWING PREPARED IN ACCORDANCE WITH ASME Y14.100-2000.
2. INTERPRET DIMENSIONS AND TOLERANCES PER ANSI Y14.5M-1994.
3. DIMENSIONS ARE IN INCHES.
4. DRAWING DEPICTS FLAT PATTERN OF FORMED PARTS DEFINED BY PRO/ENGINEER FILES SEI42C-388-XXX.PRT.
5. PROFILE TOLERANCE OF FLAT PATTERN IS +/- .010 IN.
6. THICKNESS IS 0.040 +/- .006 IN. PER ASTM B248.
7. REMOVE ALL BURRS AND SHARP EDGES.
8. IDENTIFY ALL PARTS WITH "PART NAME" BY ETCHING OR PERMANENT MARKER.

Table with 8 columns: INSTANCE NAME, HOLE, S-DIM, PART NAME. Lists 48 instances of SEI42C-388 parts, including flat plates and new components.

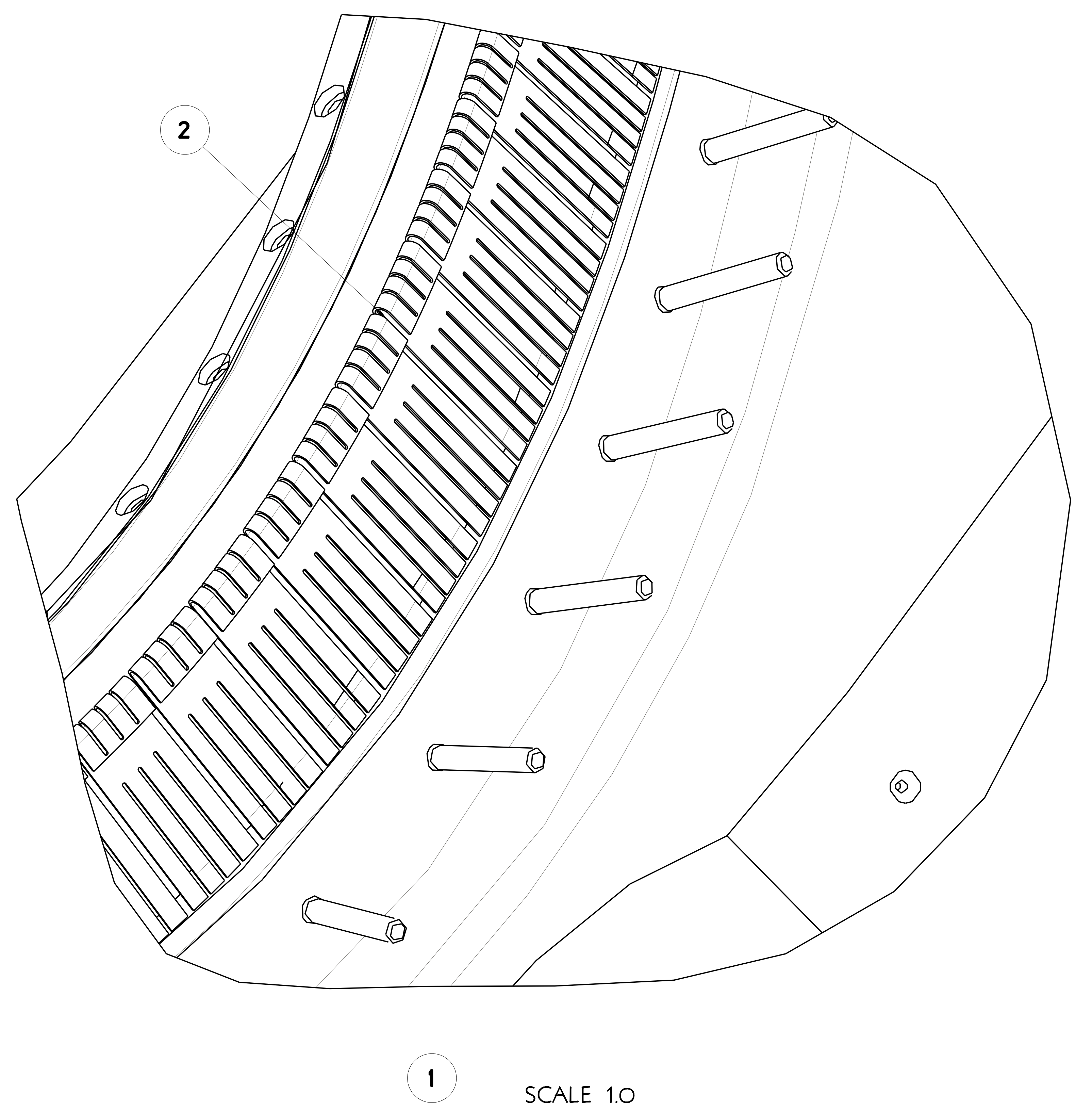

1 SCALE 1:0

RELEASED FOR FABRICATION / INSTALLATION
PPPL Drafting:

Table with 6 columns: CAGE CODE, PART OR IDENTIFYING NO, NOMENCLATURE OR DESCRIPTION, MATERIAL, SPECIFICATION, FIND NO. Includes row for CHILL PLATES and COPPER, ANNEALED UNS C10100, 10200.

NO REPRESENTATION OR WARRANTY, EXPRESSED OR IMPLIED, IS MADE AS TO THE ACCURACY, COMPLETENESS OR USEFULNESS OF THE INFORMATION OR STATEMENTS CONTAINED IN THESE DRAWINGS...

THIS DRAWING PRODUCED ON PRO-ENGINEER

Revision table with columns: REV, DESCRIPTION, BY, DATE, CHK, DEPT, DATE, PE, REG, DATE, DRN, DOE, DATE. Includes revision history for the drawing.

Project information block including SCALE NOTED, DES: T HARGROVE, DRW: RUSHINSKI, CHK: M COLE, and company logo for UT-BATTELLE Oak Ridge National Laboratory.

SEI42C-388

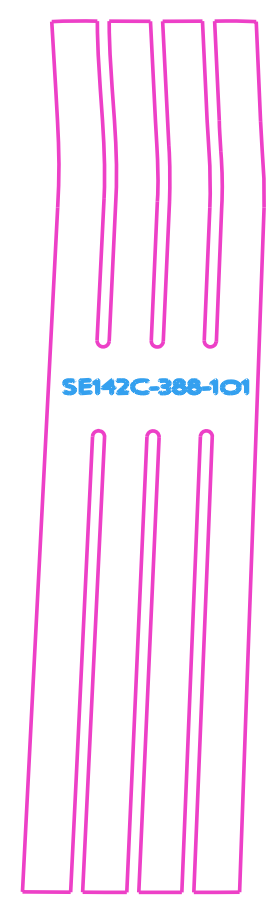

INSTANCE
SE142C-388_FLAT_101

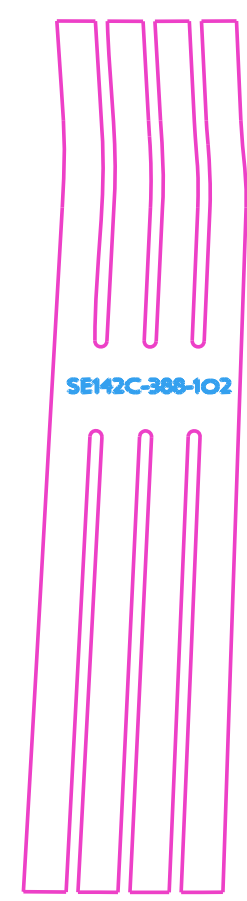

INSTANCE
SE142C-388_FLAT_102

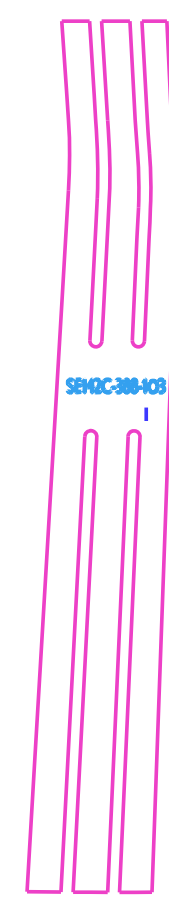

INSTANCE
SE142C-388_FLAT_103-NEW

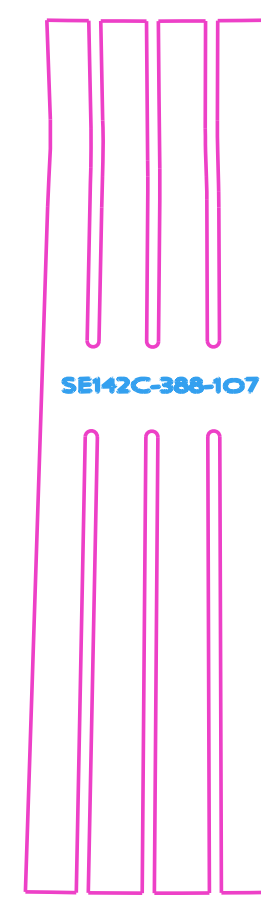

INSTANCE
SE142C-388_FLAT_107-108

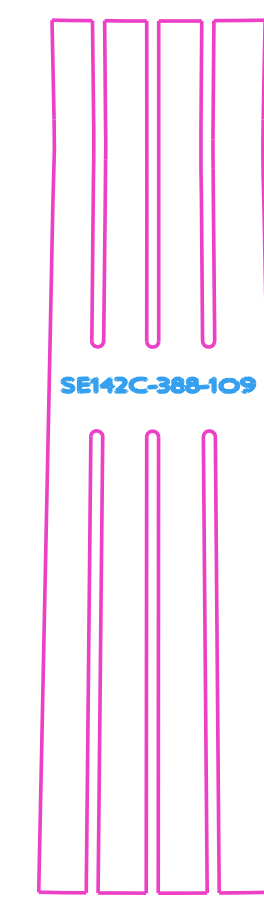

INSTANCE
SE142C-388_FLAT_109

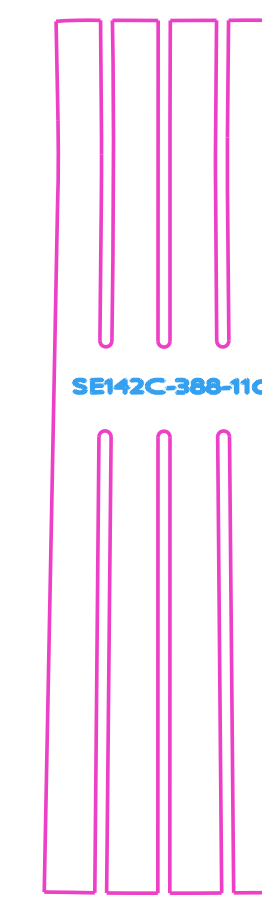

INSTANCE
SE142C-388_FLAT_110

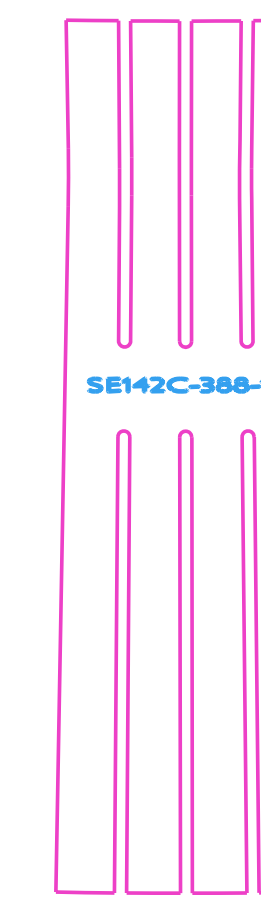

INSTANCE
SE142C-388_FLAT_111



INSTANCE
SE142C-388_FLAT_112

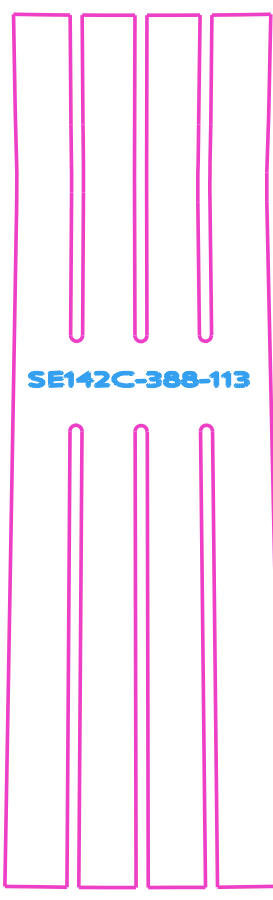

INSTANCE
SE142C-388_FLAT_113

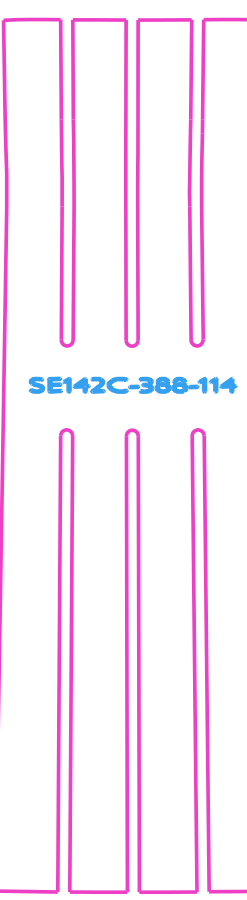

INSTANCE
SE142C-388_FLAT_114

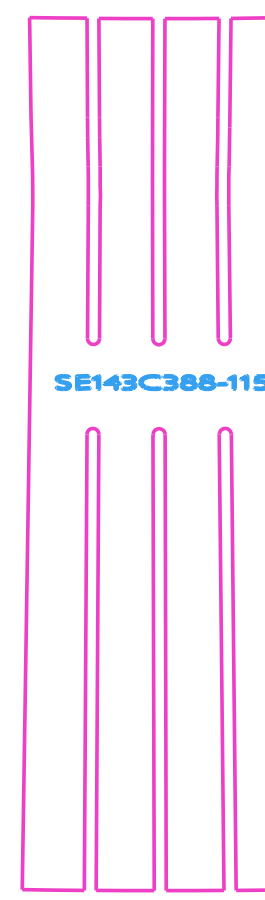

INSTANCE
SE142C-388_FLAT_115

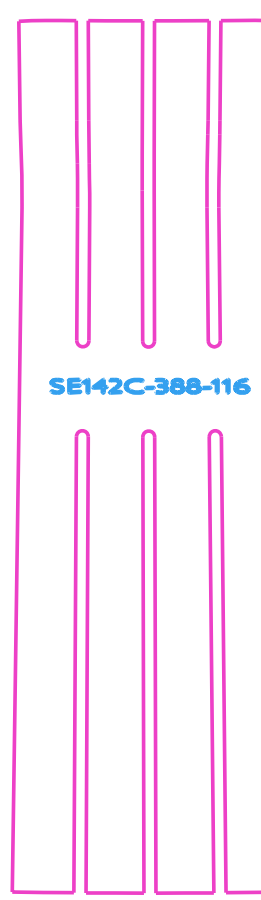

INSTANCE
SE142C-388_FLAT_116

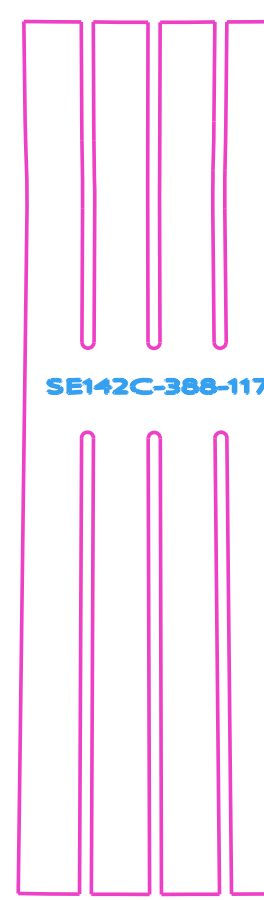

INSTANCE
SE142C-388_FLAT_117

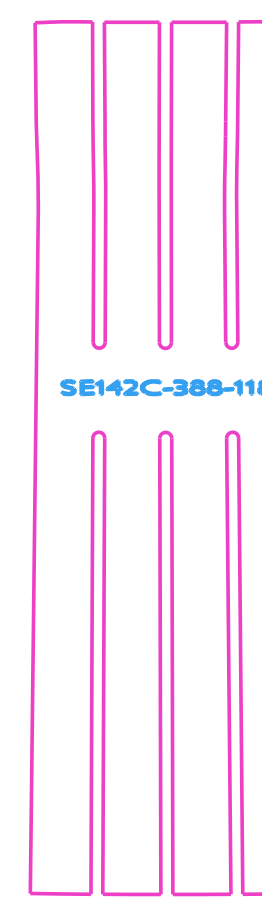

INSTANCE
SE142C-388_FLAT_118



INSTANCE
SE142C-388_FLAT_119



INSTANCE
SE142C-388_FLAT_120

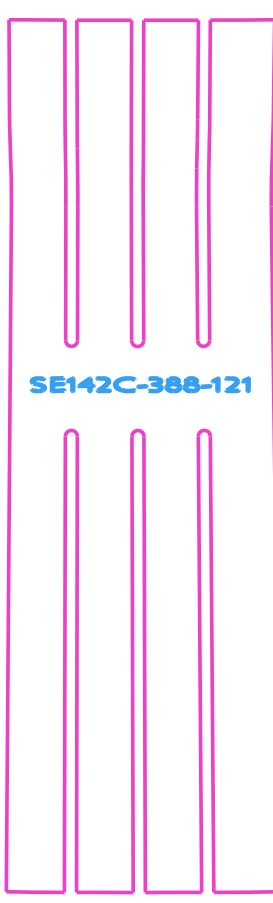

INSTANCE
SE142C-388_FLAT_121

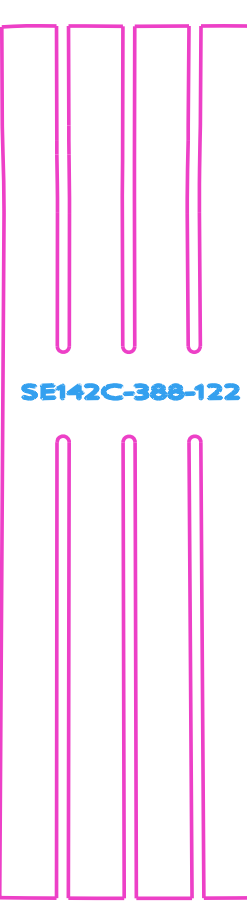

INSTANCE
SE142C-388_FLAT_122

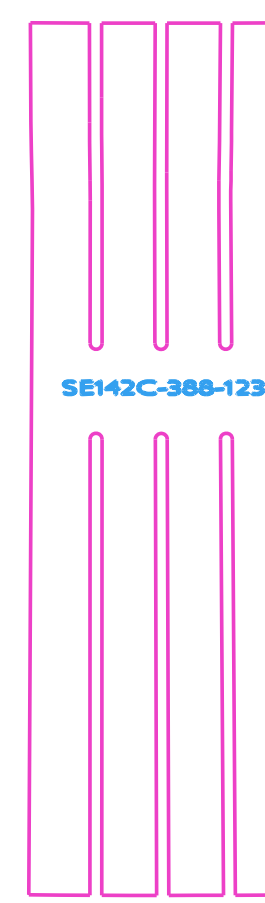

INSTANCE
SE142C-388_FLAT_123

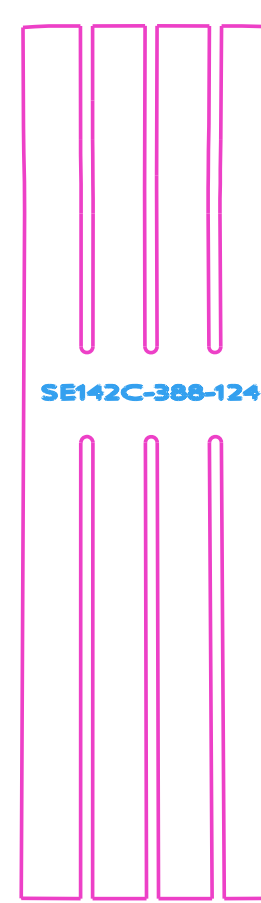

INSTANCE
SE142C-388_FLAT_124

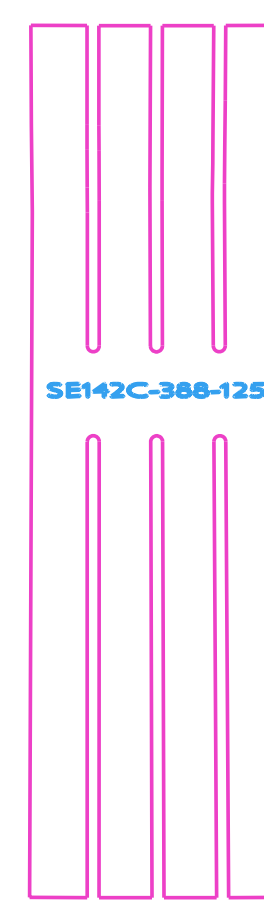

INSTANCE
SE142C-388_FLAT_125

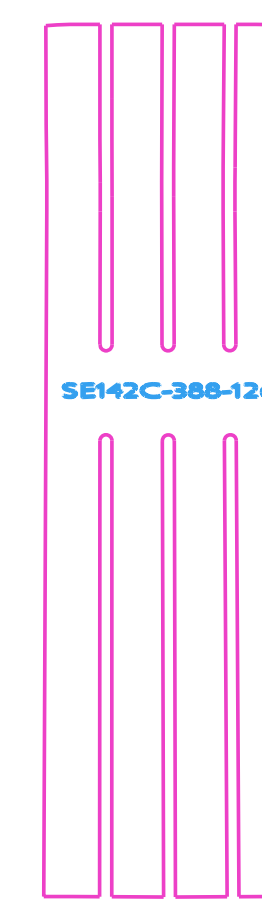

INSTANCE
SE142C-388_FLAT_126



INSTANCE
SE142C-388_FLAT_127

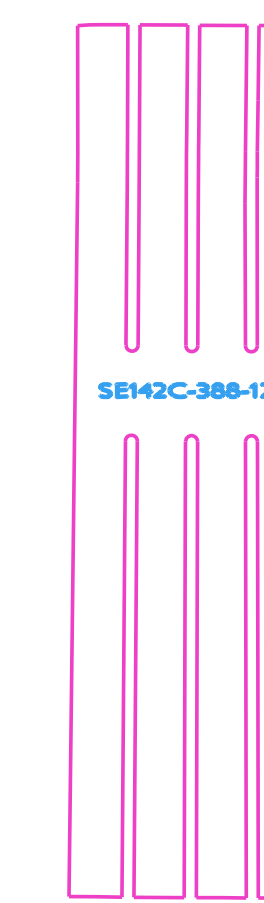

INSTANCE
SE142C-388_FLAT_128

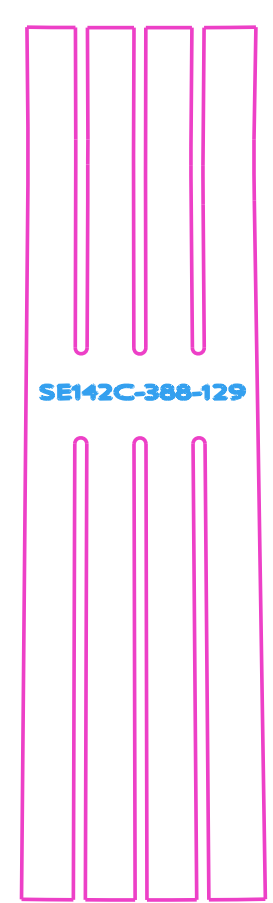

INSTANCE
SE142C-388_FLAT_129

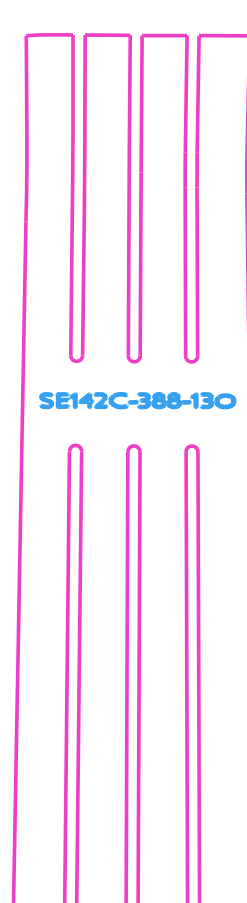

INSTANCE
SE142C-388_FLAT_130

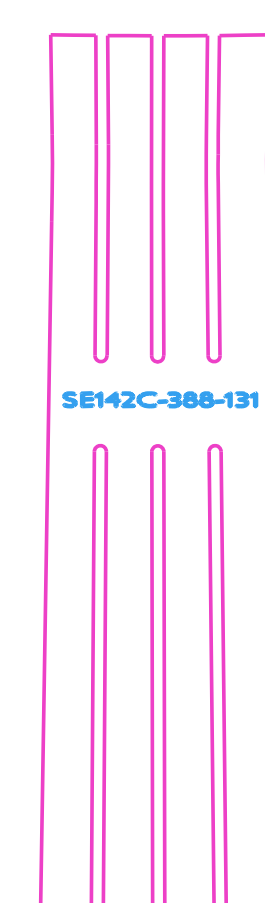

INSTANCE
SE142C-388_FLAT_131

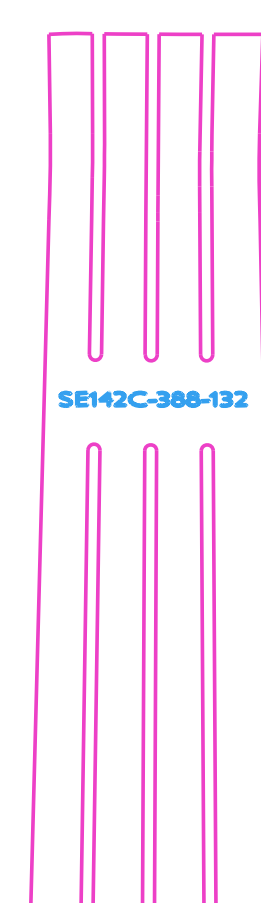

INSTANCE
SE142C-388_FLAT_132

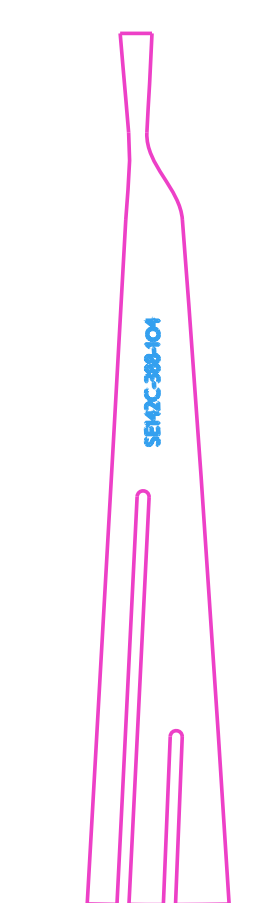

INSTANCE
SE142C-388_FLAT_NEW_104



INSTANCE
SE142C-388_FLAT_NEW_106



INSTANCE
SE142C-388_FLAT_NEW_107

**RELEASED FOR
FABRICATION / INSTALLATION**
 PPPL Drafting:

Oak Ridge National Laboratory managed for the DEPARTMENT OF ENERGY under U.S. GOVERNMENT contract DE-AC05-00OR22725 UT-BATTELLE, LLC, Oak Ridge, Tennessee						
UT-BATTELLE						
NATIONAL COMPACT STELLARATOR EXPERIMENT						
MODULAR COIL TYPE - C SIDE "A" LOWER BOTTOM CHILL PLATE FLAT PATTERN LAYOUT						
VERSION NO.	PLANT	BLDG	FL	SHT OF	TYPE	CLASS
9+	X-10	5700	3	2	7	S U
RELEASE LEVEL		SE142C-388		REV		0
Fabrication						

SE142C-388

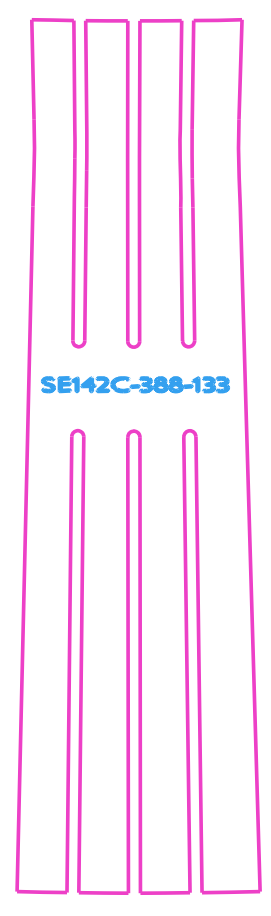

INSTANCE SE142C-388_FLAT_133

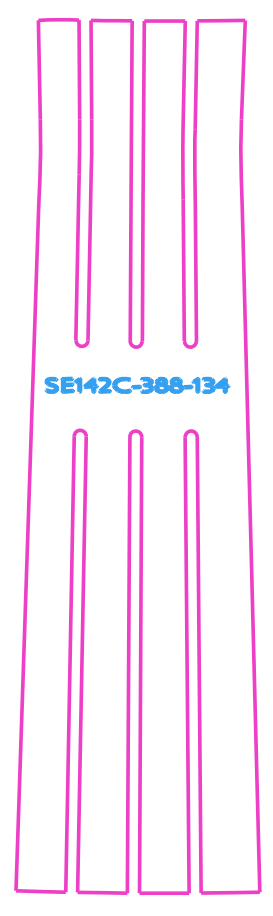

INSTANCE SE142C-388_FLAT_134

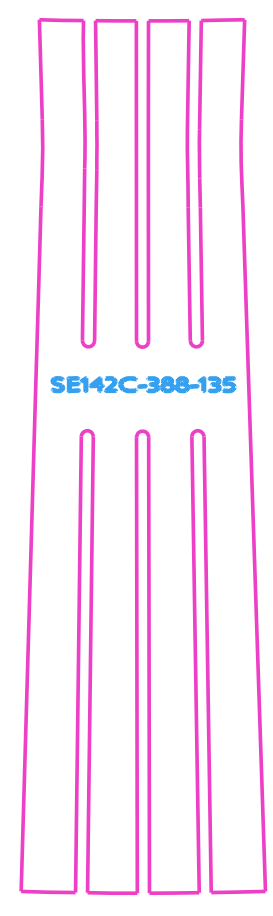

INSTANCE SE142C-388_FLAT_135

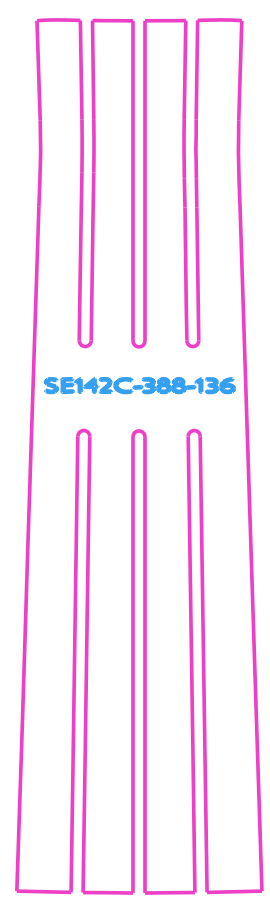

INSTANCE SE142C-388_FLAT_136

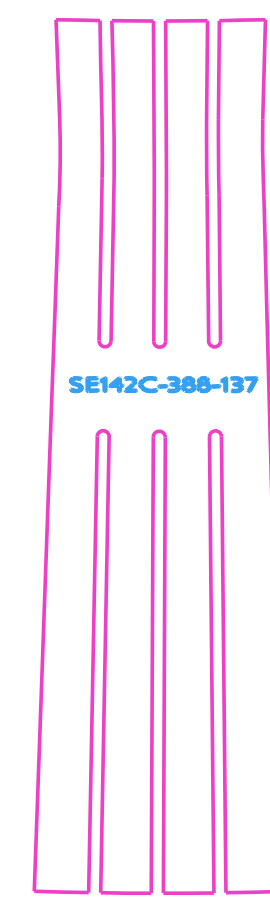

INSTANCE SE142C-388_FLAT_137

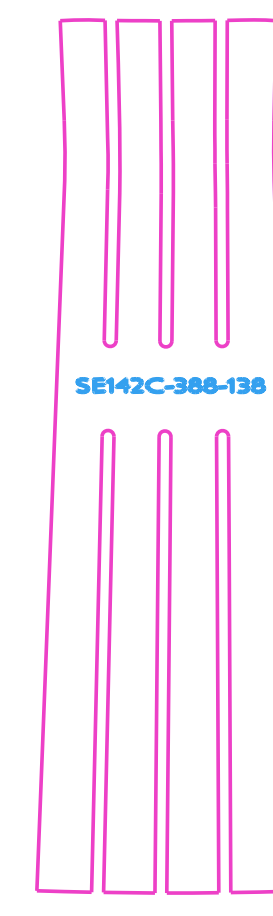

INSTANCE SE142C-388_FLAT_138



INSTANCE SE142C-388_FLAT_139

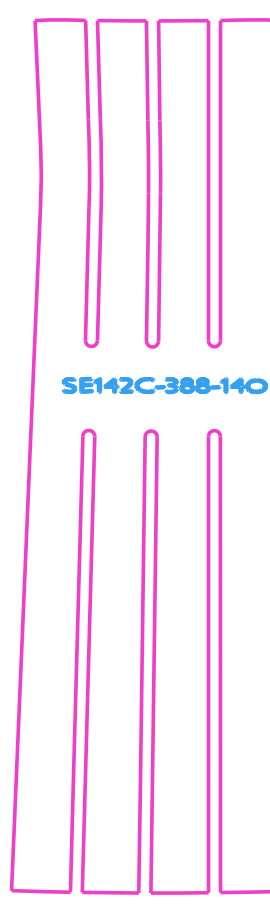

INSTANCE SE142C-388_FLAT_140

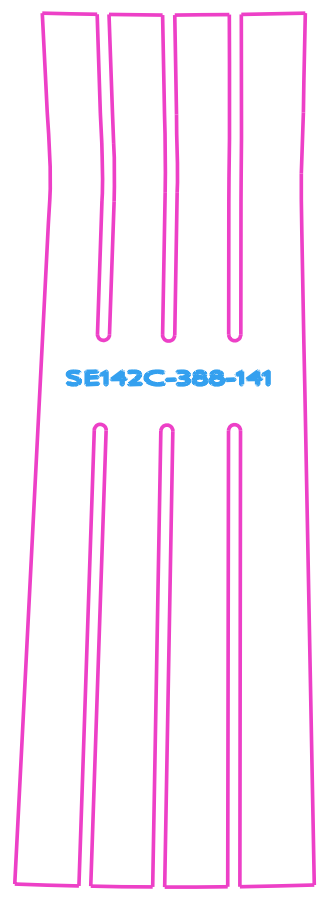

INSTANCE SE142C-388_FLAT_141

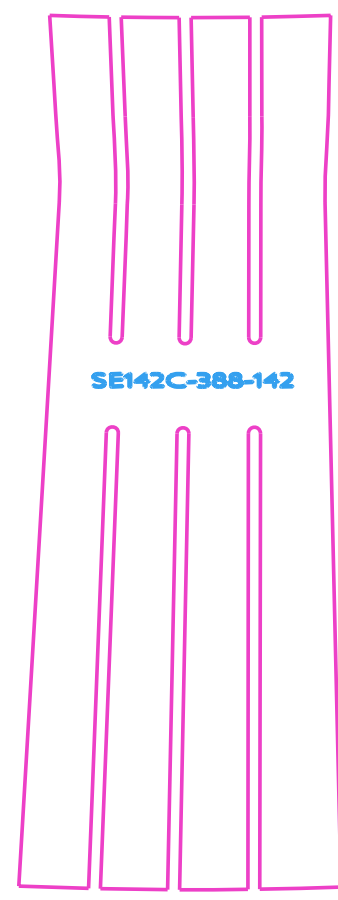

INSTANCE SE142C-388_FLAT_142

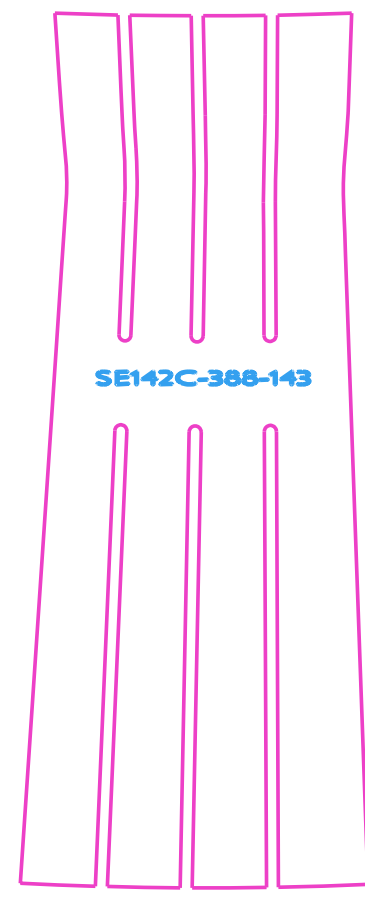

INSTANCE SE142C-388_FLAT_143

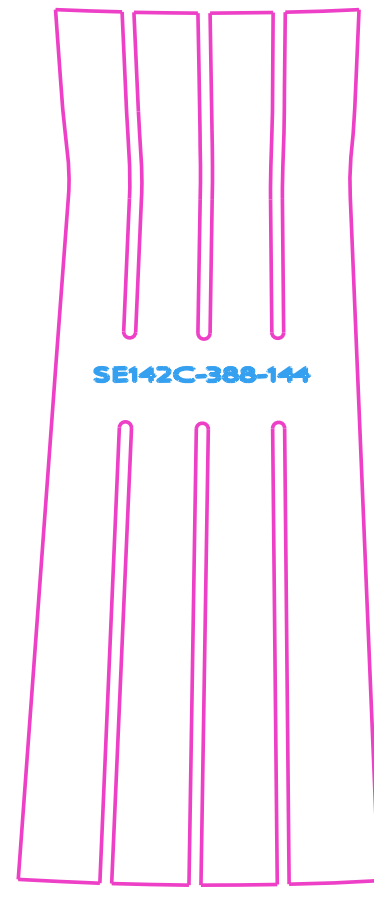

INSTANCE SE142C-388_FLAT_144

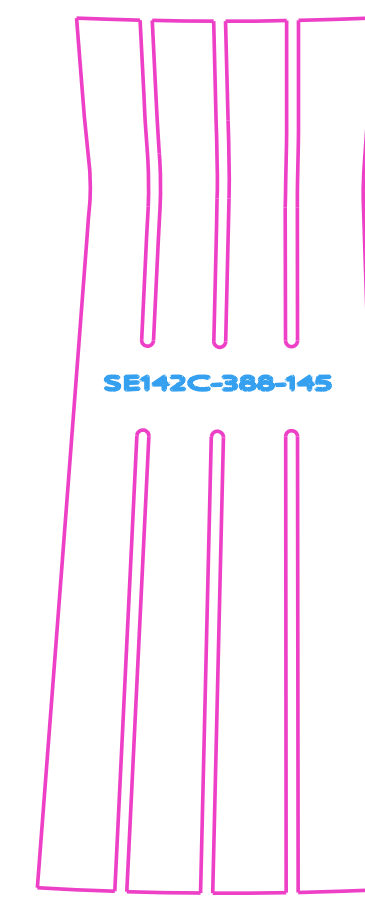

INSTANCE SE142C-388_FLAT_145

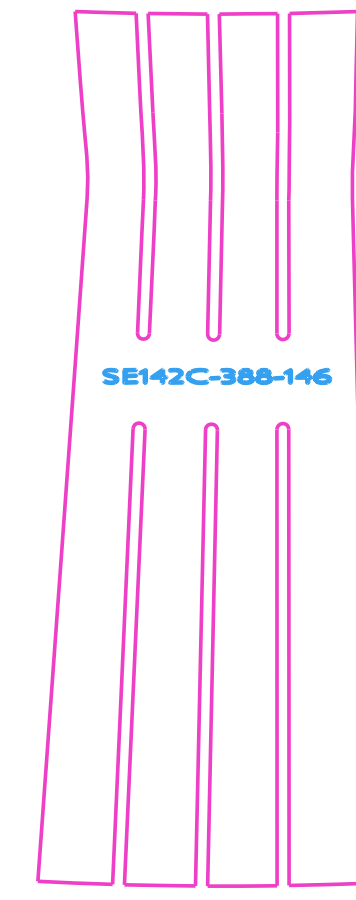

INSTANCE SE142C-388_FLAT_146

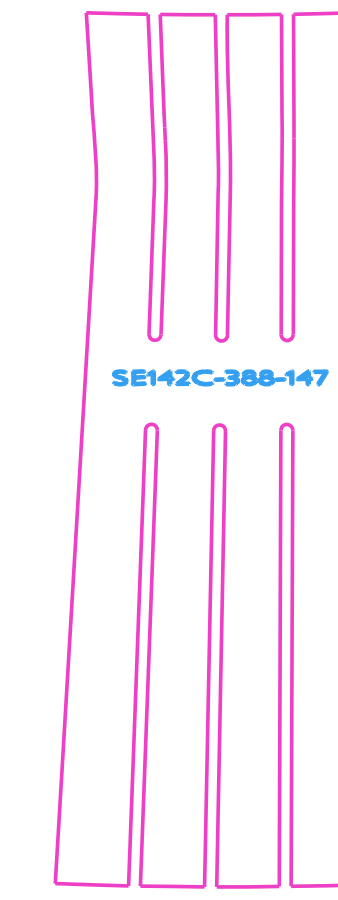

INSTANCE SE142C-388_FLAT_147

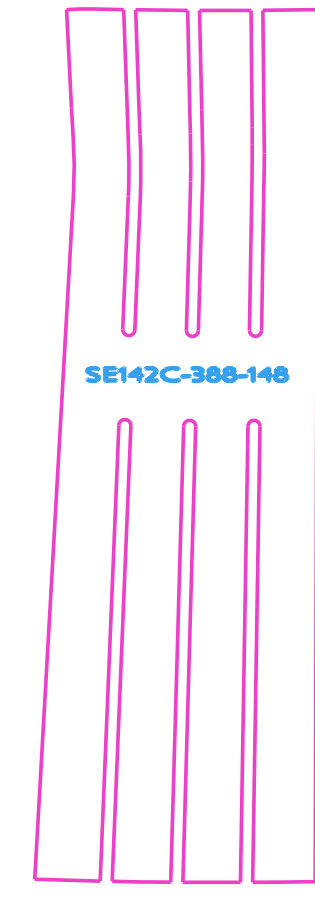

INSTANCE SE142C-388_FLAT_148

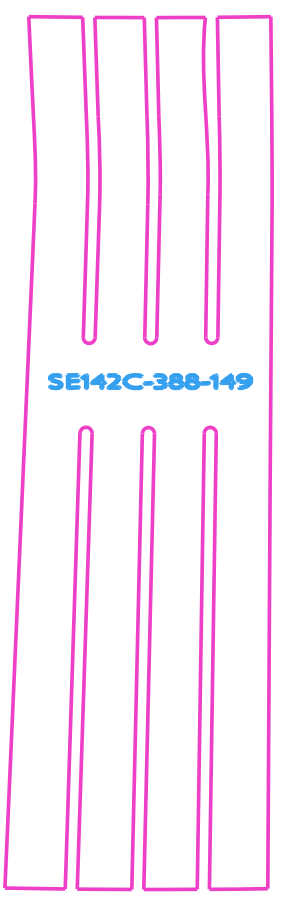

INSTANCE SE142C-388_FLAT_149

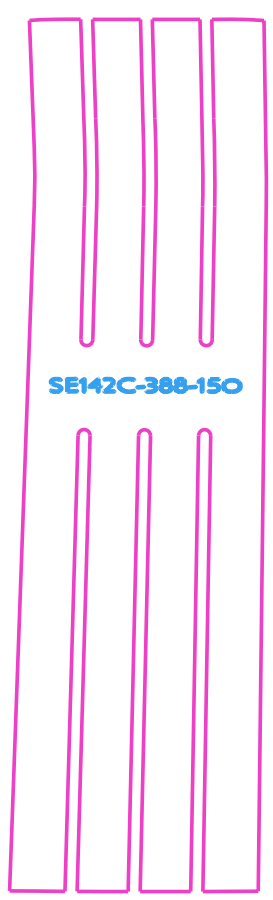

INSTANCE SE142C-388_FLAT_150

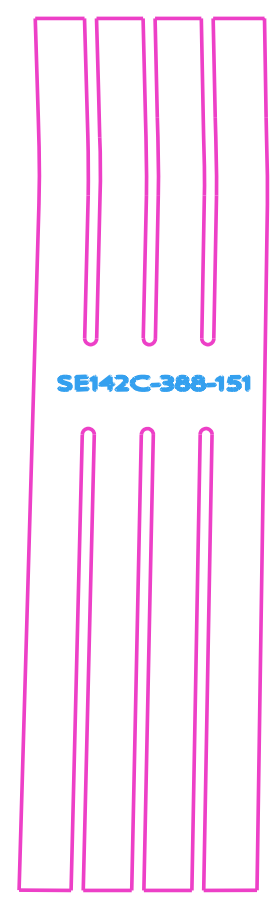

INSTANCE SE142C-388_FLAT_151

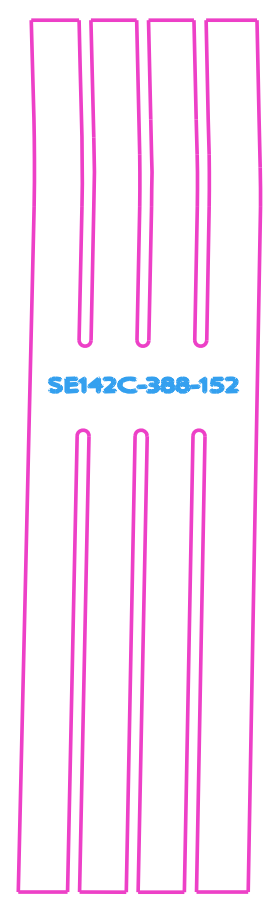

INSTANCE SE142C-388_FLAT_152

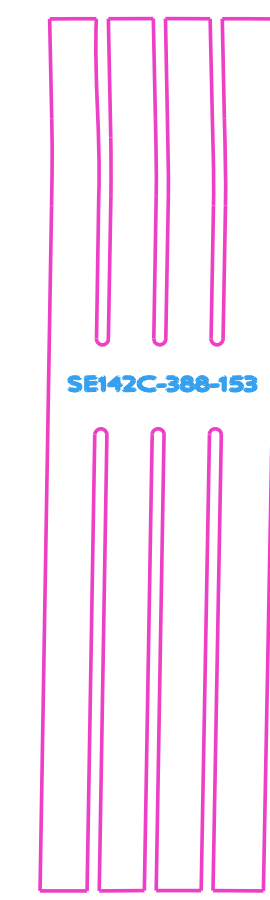

INSTANCE SE142C-388_FLAT_153

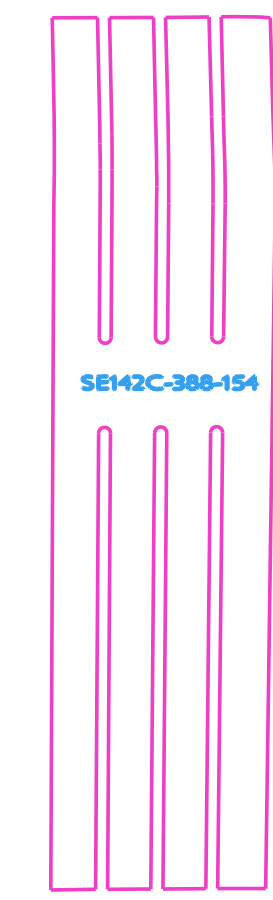

INSTANCE SE142C-388_FLAT_154

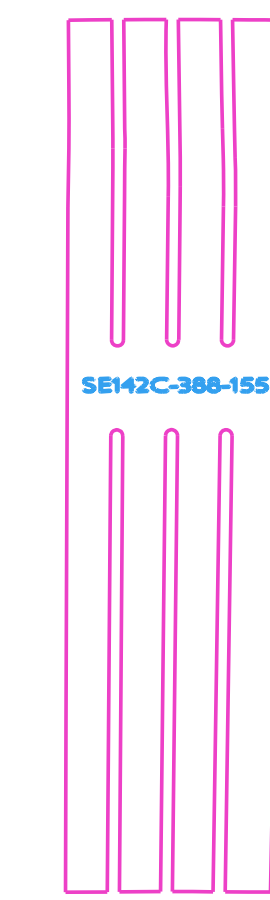

INSTANCE SE142C-388_FLAT_155

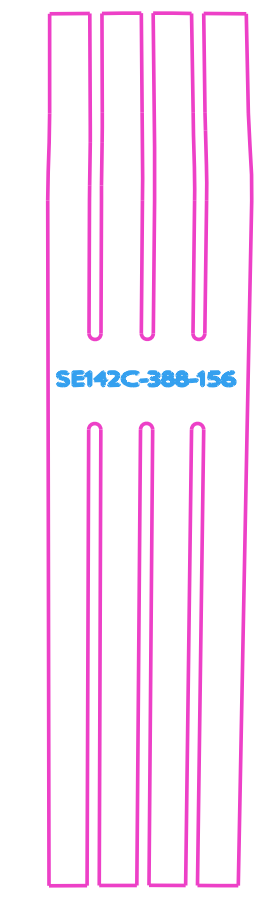

INSTANCE SE142C-388_FLAT_156

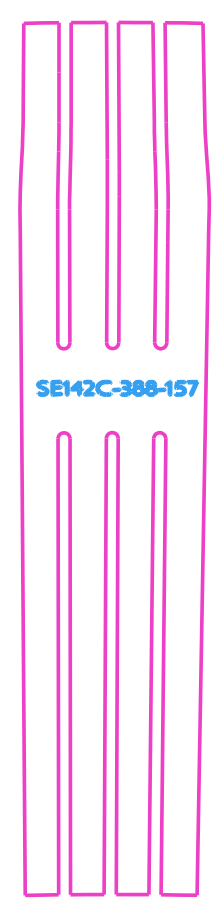

INSTANCE SE142C-388_FLAT_157



INSTANCE SE142C-388_FLAT_158

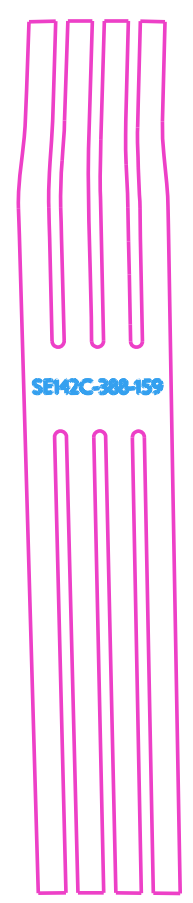

INSTANCE SE142C-388_FLAT_159

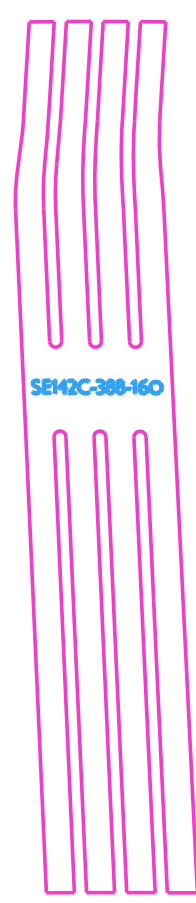

INSTANCE SE142C-388_FLAT_160



INSTANCE SE142C-388_FLAT_161



INSTANCE SE142C-388_FLAT_162



INSTANCE SE142C-388_FLAT_163

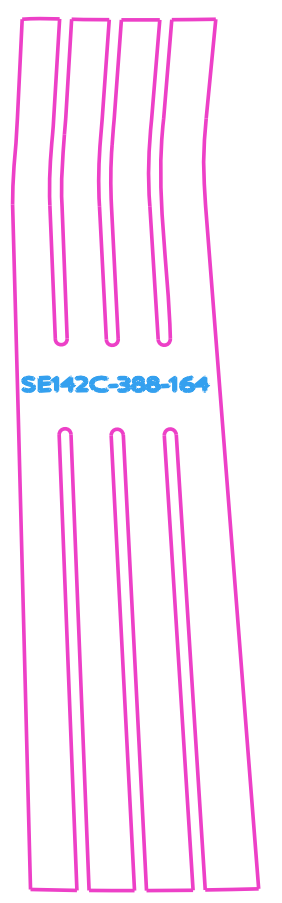

INSTANCE SE142C-388_FLAT_164

RELEASED FOR FABRICATION / INSTALLATION
PPPL Drafting:

Oak Ridge National Laboratory managed for the DEPARTMENT OF ENERGY under U.S. GOVERNMENT contract DE-AC05-00OR22725 UT-BATTELLE, LLC, Oak Ridge, Tennessee						
UT-BATTELLE NATIONAL COMPACT STELLARATOR EXPERIMENT MODULAR COIL TYPE - C SIDE "A" LOWER BOTTOM CHILL PLATE FLAT PATTERN LAYOUT						
VERSION NO.	PLANT	BLDG	FL	SHT OF	TYPE	CLASS
1	X-10	5700	3	37	S	U
RELEASE LEVEL		SE142C-388		REV		
Fabrication				0		

SE142C-388

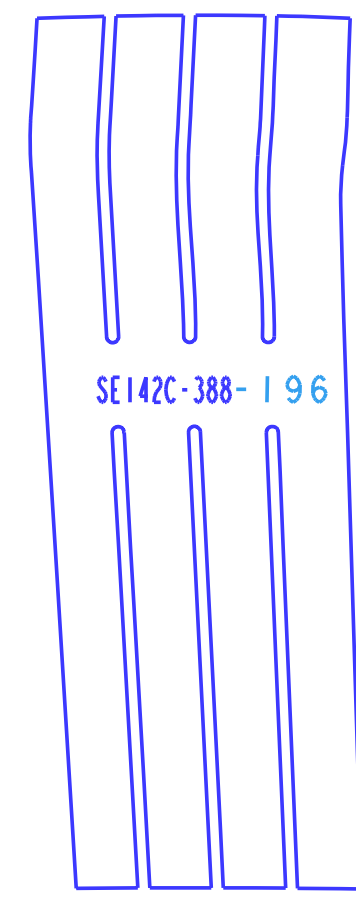

INSTANCE SE142C-388_FLAT_196

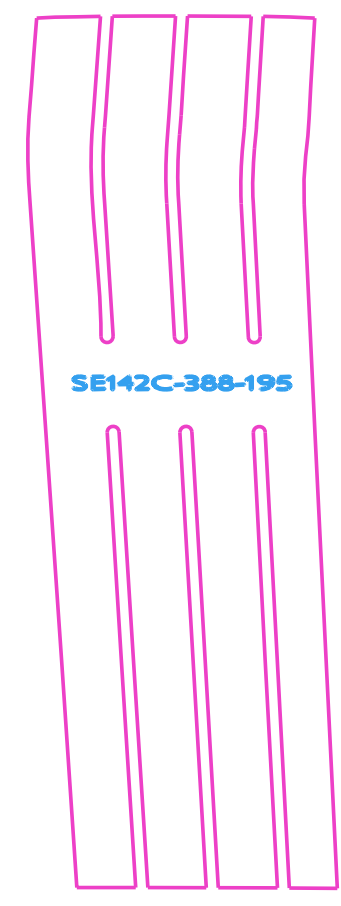

INSTANCE SE142C-388_FLAT_195_NEW

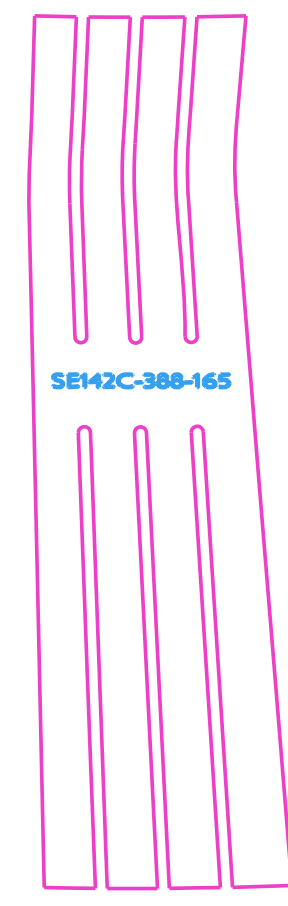

INSTANCE SE142C-388_FLAT_165

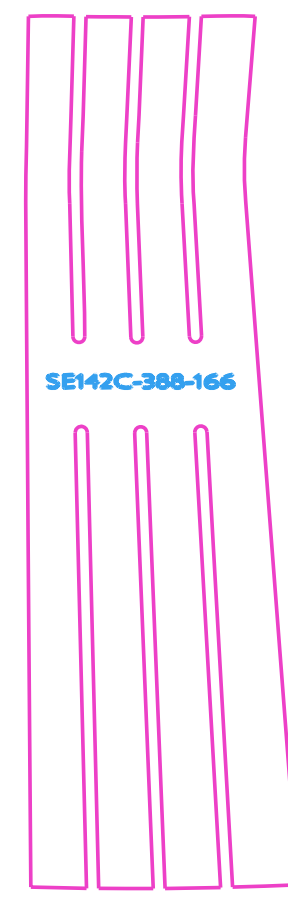

INSTANCE SE142C-388_FLAT_166

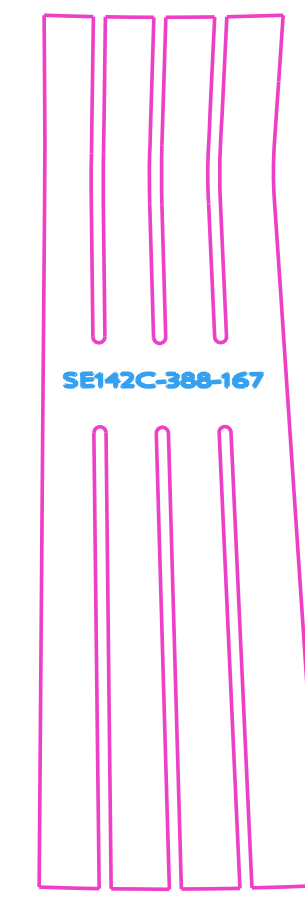

INSTANCE SE142C-388_FLAT_167

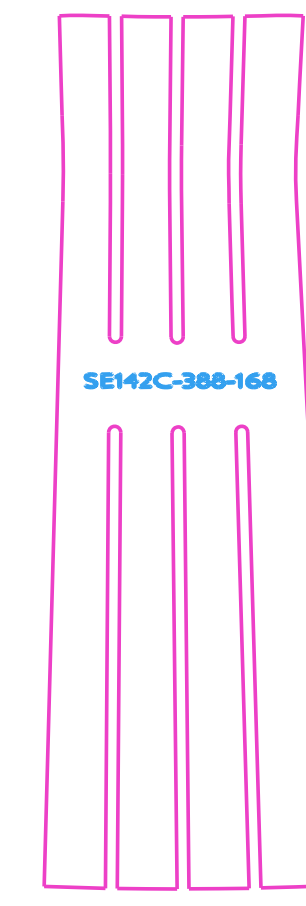

INSTANCE SE142C-388_FLAT_168

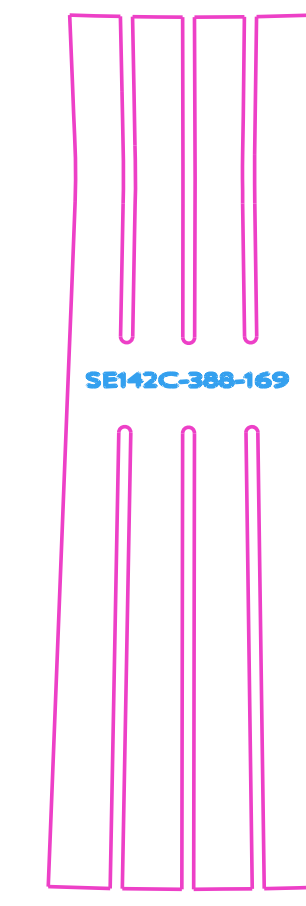

INSTANCE SE142C-388_FLAT_169

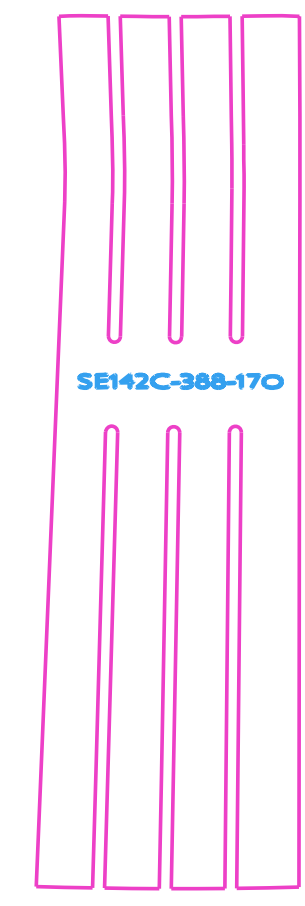

INSTANCE SE142C-388_FLAT_170

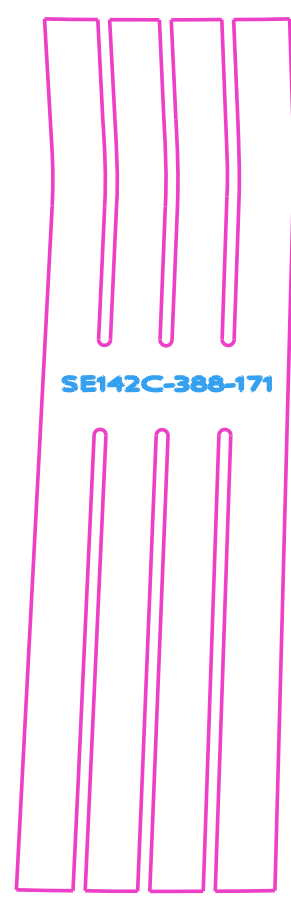

INSTANCE SE142C-388_FLAT_171

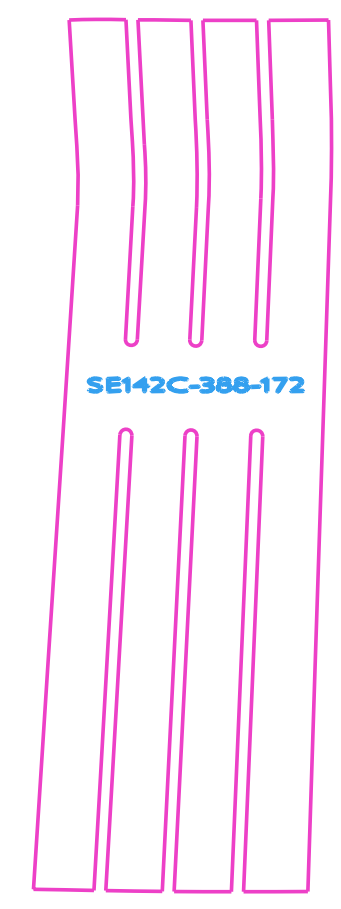

INSTANCE SE142C-388_FLAT_172

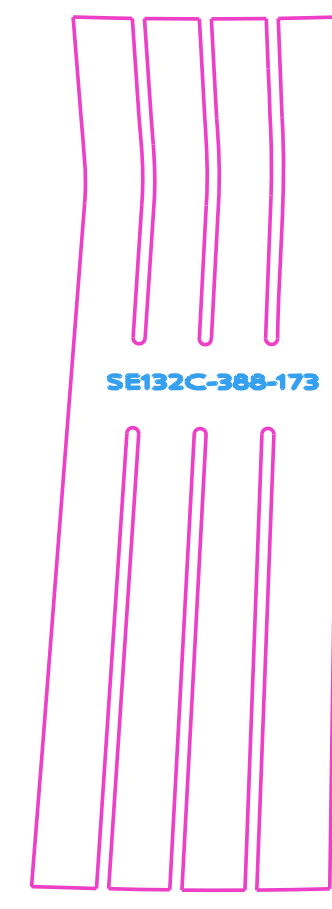

INSTANCE SE142C-388_FLAT_173

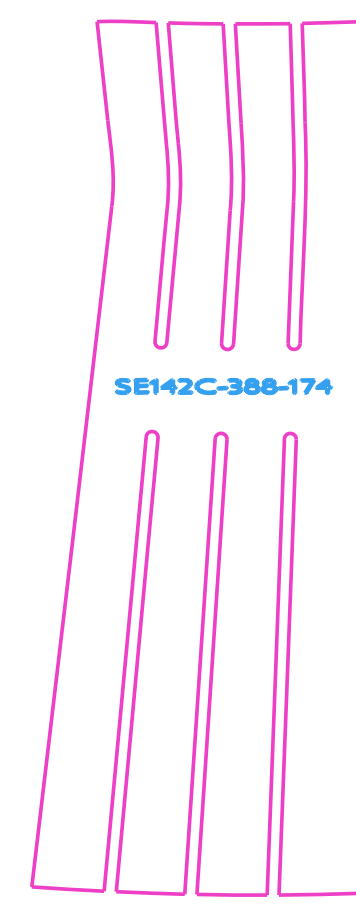

INSTANCE SE142C-388_FLAT_174

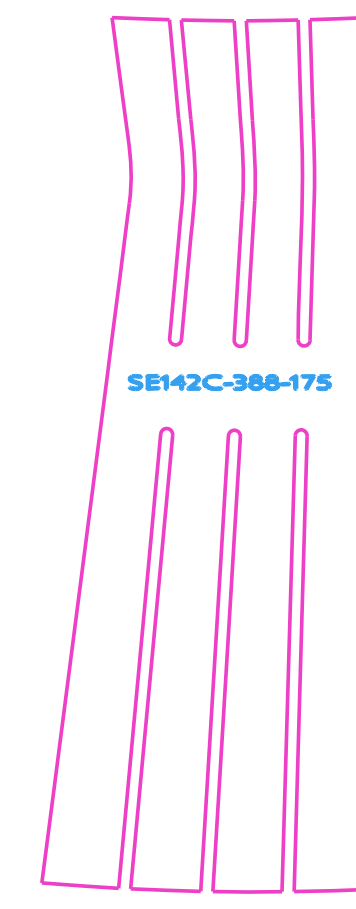

INSTANCE SE142C-388_FLAT_175

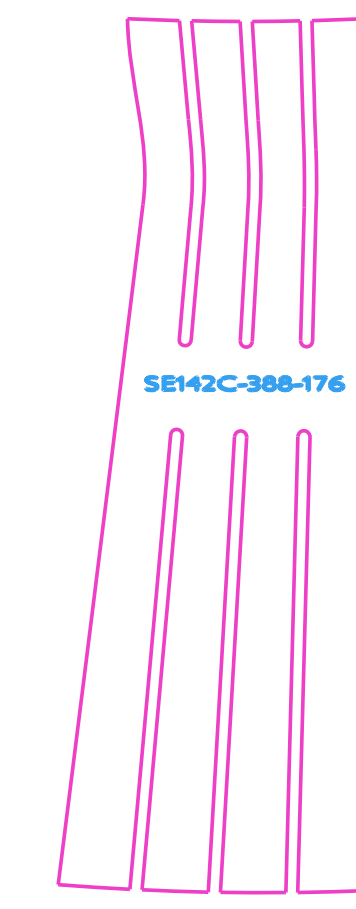

INSTANCE SE142C-388_FLAT_176

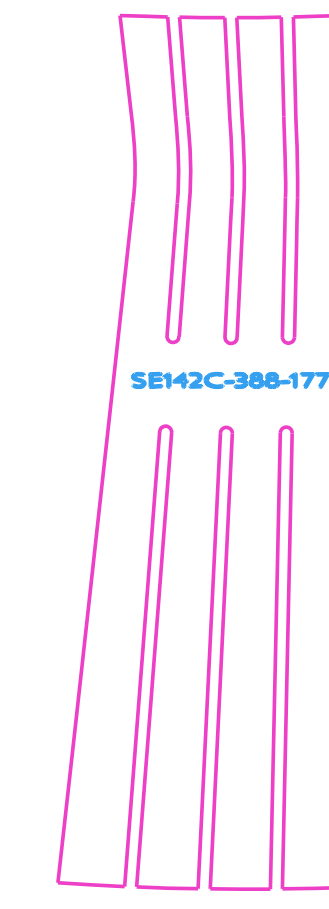

INSTANCE SE142C-388_FLAT_177

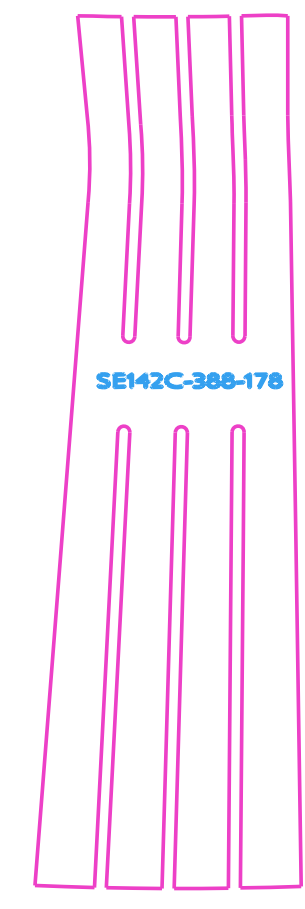

INSTANCE SE142C-388_FLAT_178

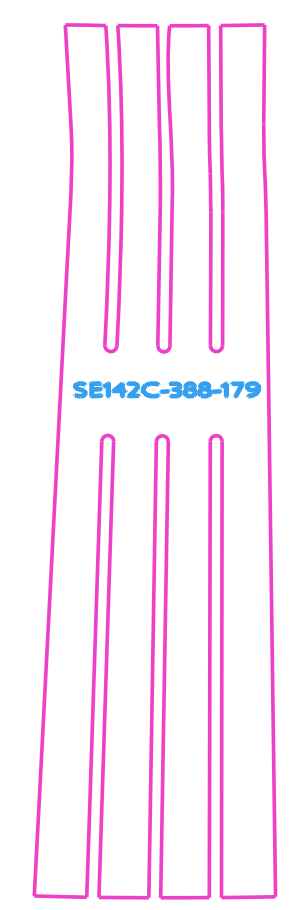

INSTANCE SE142C-388_FLAT_179

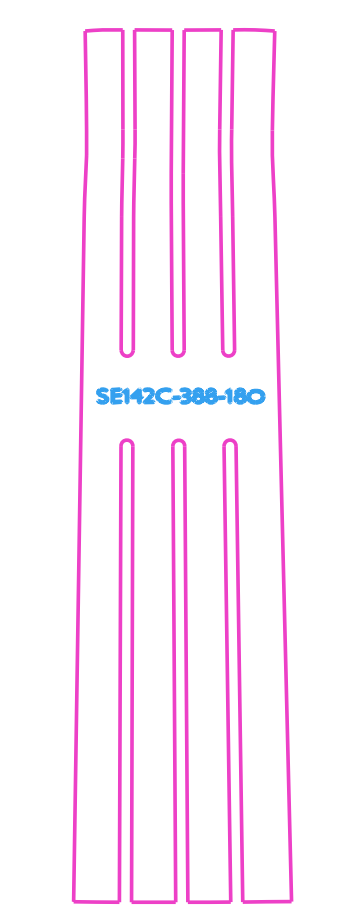

INSTANCE SE142C-388_FLAT_180

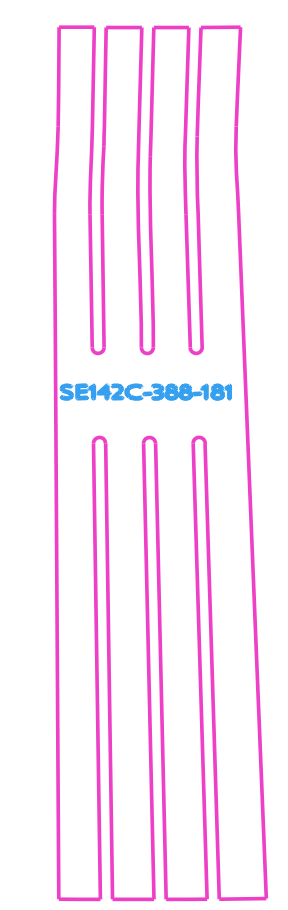

INSTANCE SE142C-388_FLAT_181

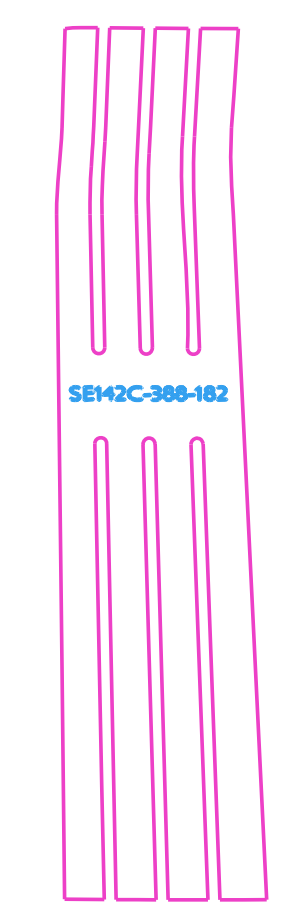

INSTANCE SE142C-388_FLAT_182

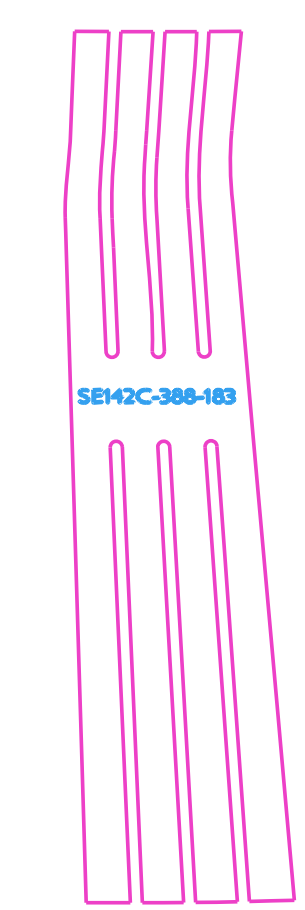

INSTANCE SE142C-388_FLAT_183

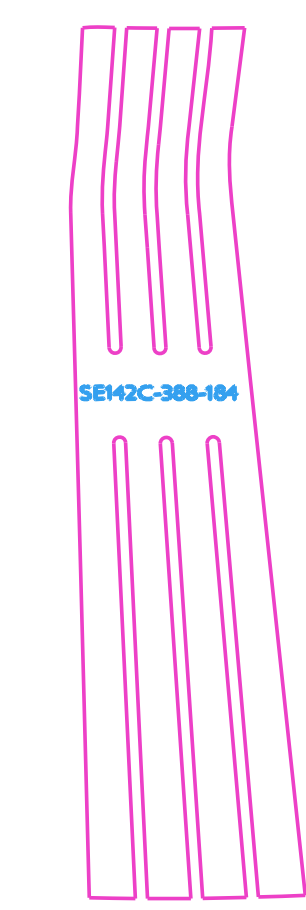

INSTANCE SE142C-388_FLAT_184

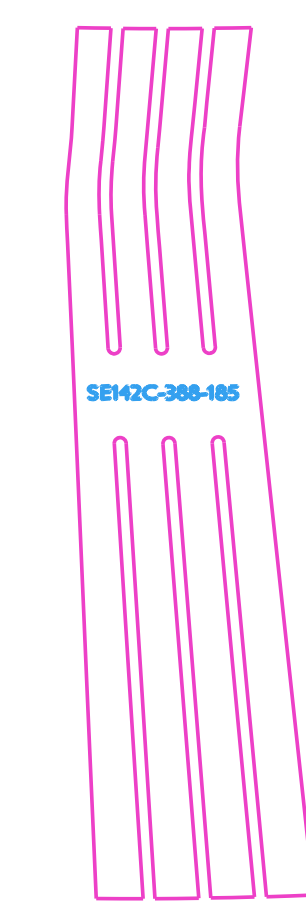

INSTANCE SE142C-388_FLAT_185

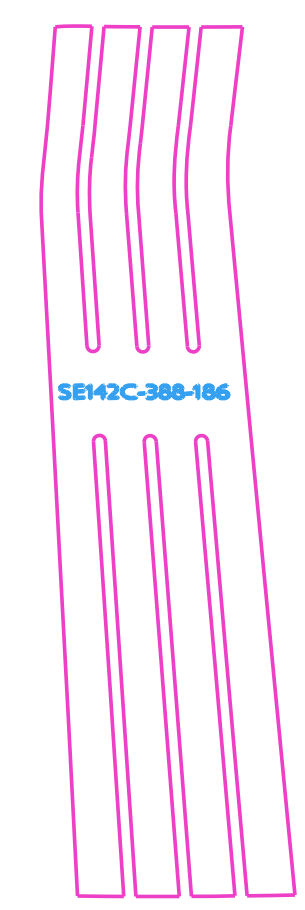

INSTANCE SE142C-388_FLAT_186

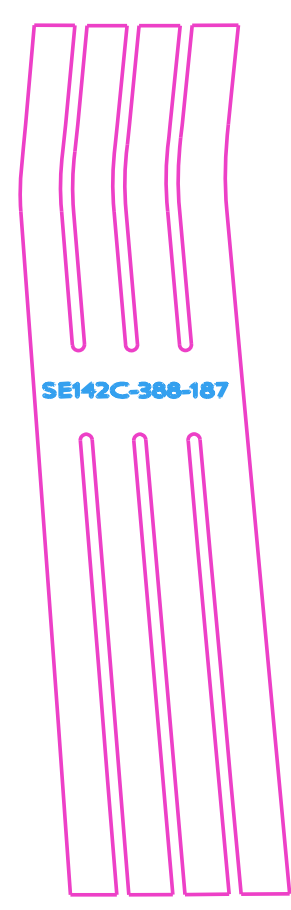

INSTANCE SE142C-388_FLAT_187

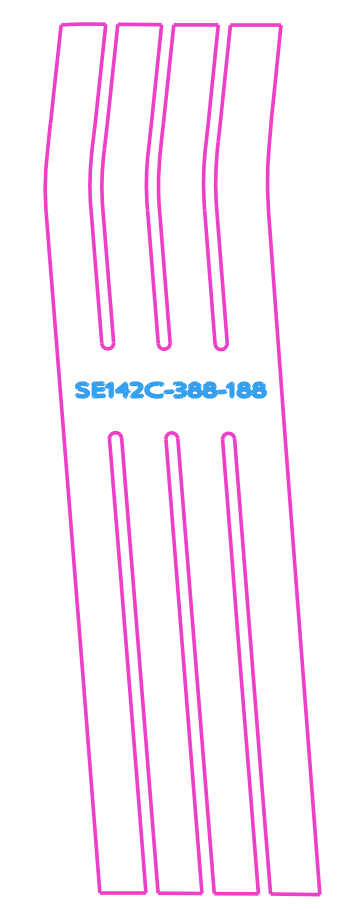

INSTANCE SE142C-388_FLAT_188

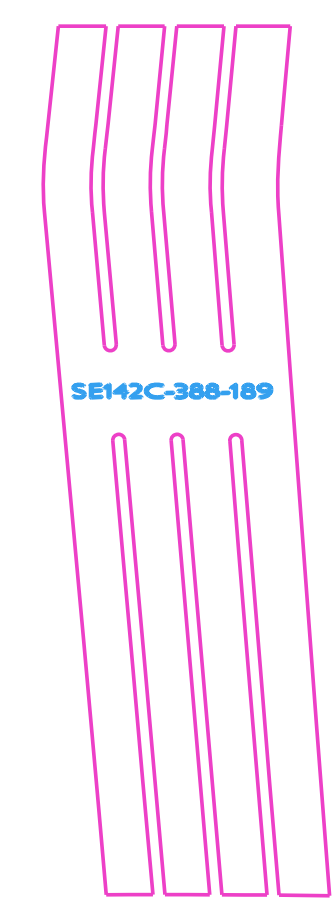

INSTANCE SE142C-388_FLAT_189

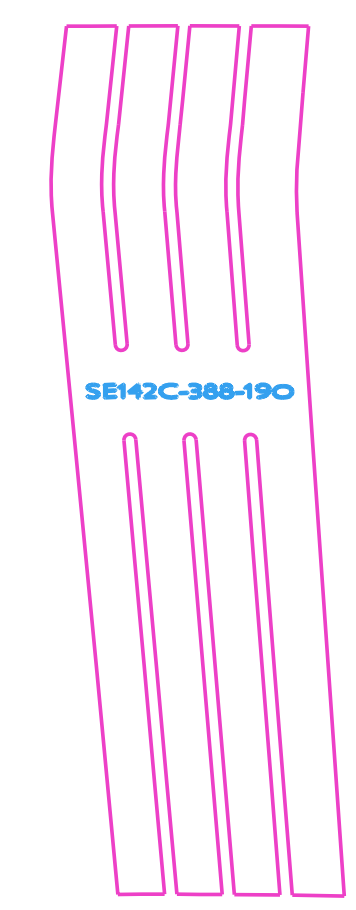

INSTANCE SE142C-388_FLAT_190

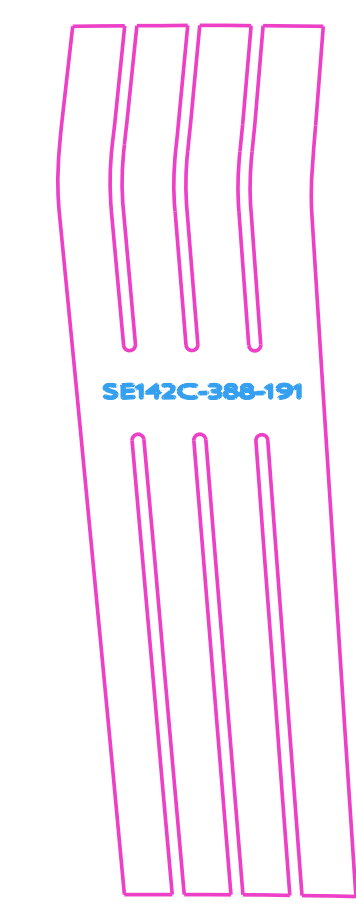

INSTANCE SE142C-388_FLAT_191

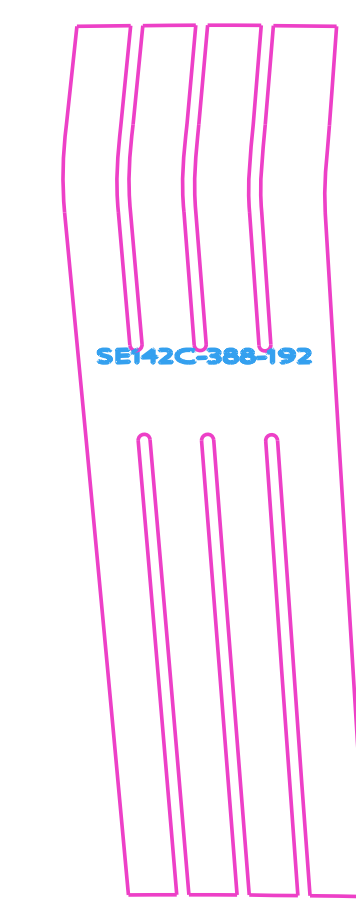

INSTANCE SE142C-388_FLAT_192

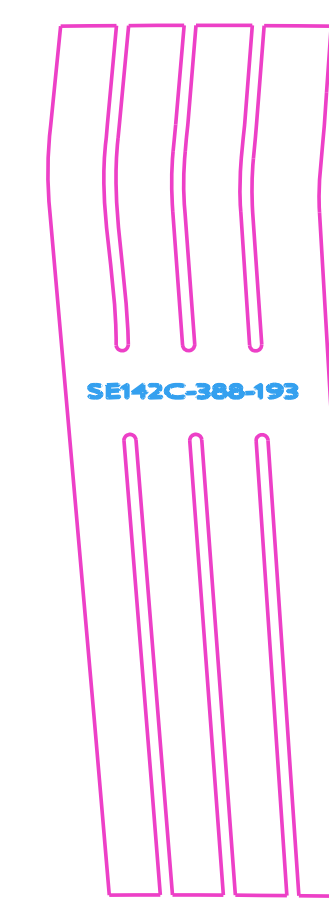

INSTANCE SE142C-388_FLAT_193

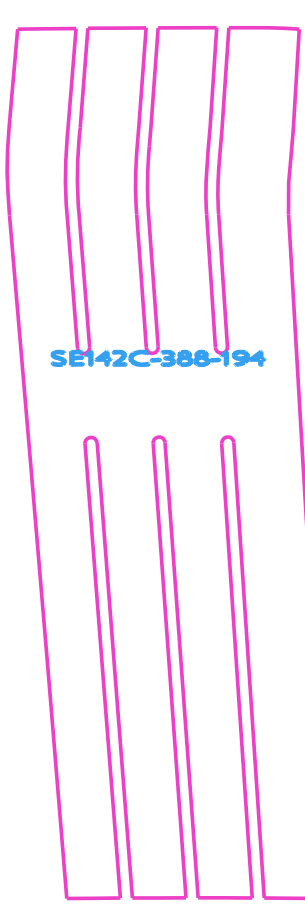

INSTANCE SE142C-388_FLAT_194

RELEASED FOR FABRICATION / INSTALLATION
PPPL Drafting:

Oak Ridge National Laboratory managed for the DEPARTMENT OF ENERGY under U.S. GOVERNMENT CONTRACT DE-AC05-00OR22725 UT-BATTELLE, LLC, Oak Ridge, Tennessee							
UT-BATTELLE NATIONAL COMPACT STELLARATOR EXPERIMENT MODULAR COIL TYPE - C SIDE "A" LOWER BOTTOM CHILL PLATE FLAT PATTERN LAYOUT							
VERSION NO.	PLANT	BLDG	FL	SHT OF	TYPE	CLASS	
1	X-10	5700	3	4	7	S	U
RELEASE LEVEL		SE142C-388		REV		0	
Fabrication							

SE142C-388

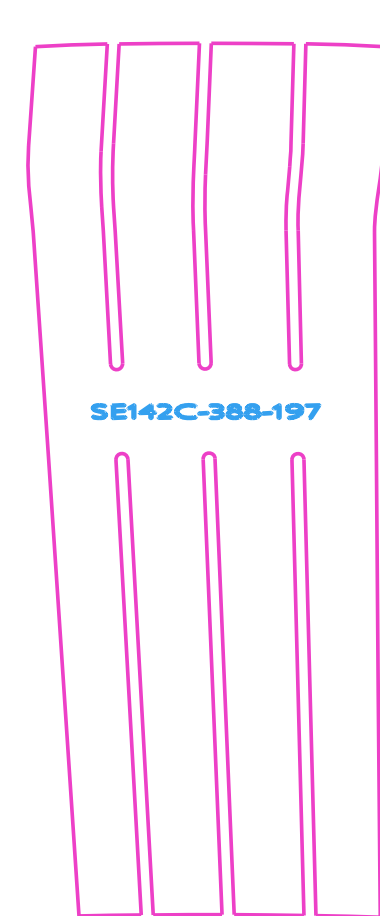

INSTANCE SE142C-388_FLAT_197

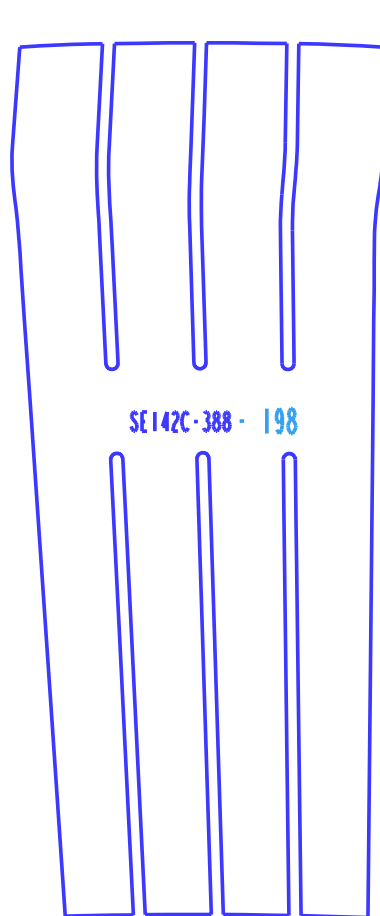

INSTANCE SE142C-388_FLAT_NEW_198

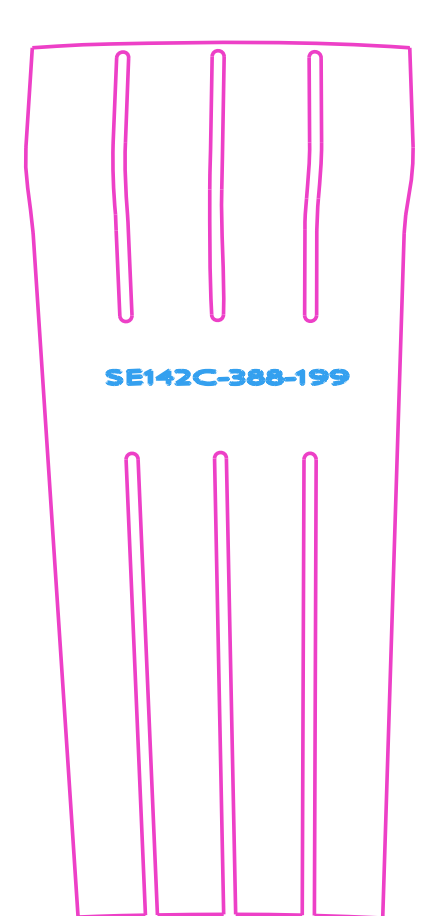

INSTANCE SE142C-388_FLAT_NEW_292

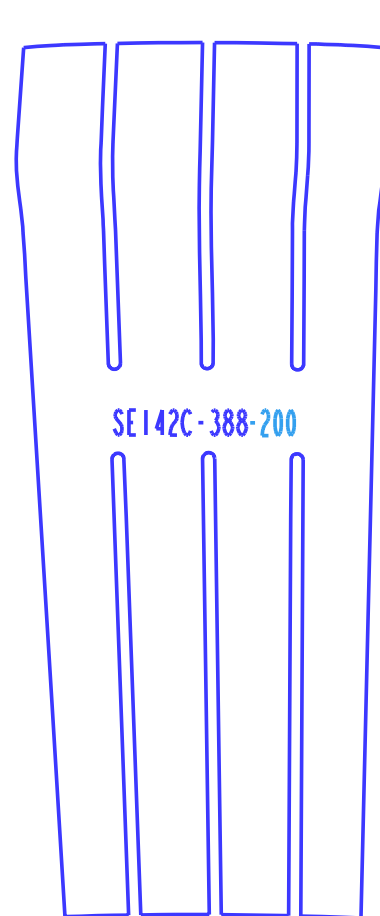

INSTANCE SE142C-388_FLAT_198

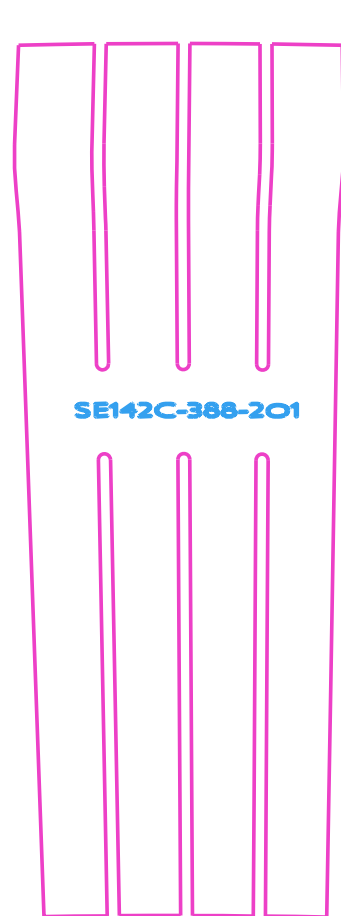

INSTANCE SE142C-388_FLAT_201

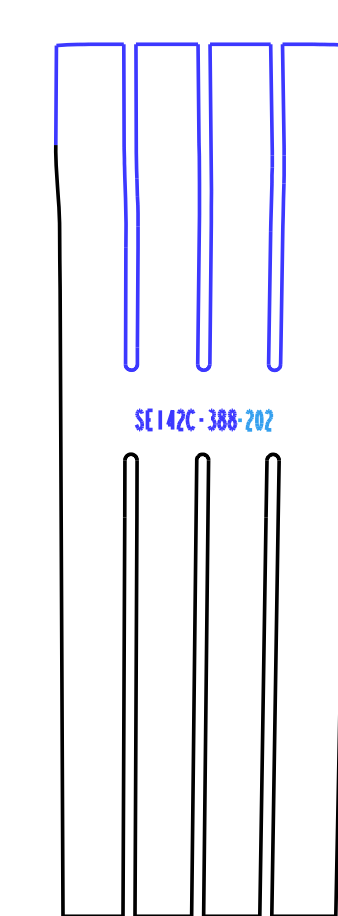

INSTANCE SE142C-388_FLAT_202

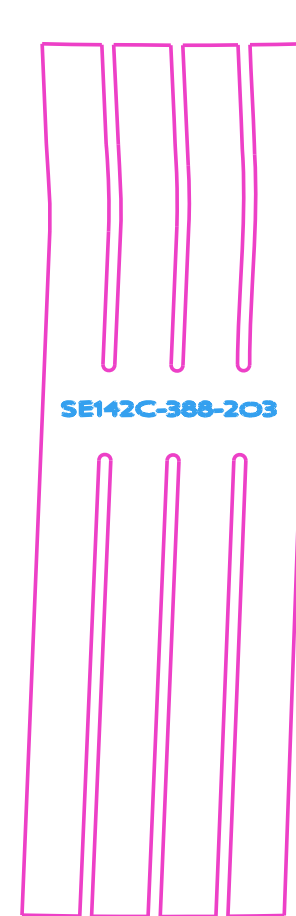

INSTANCE SE142C-388_FLAT_203

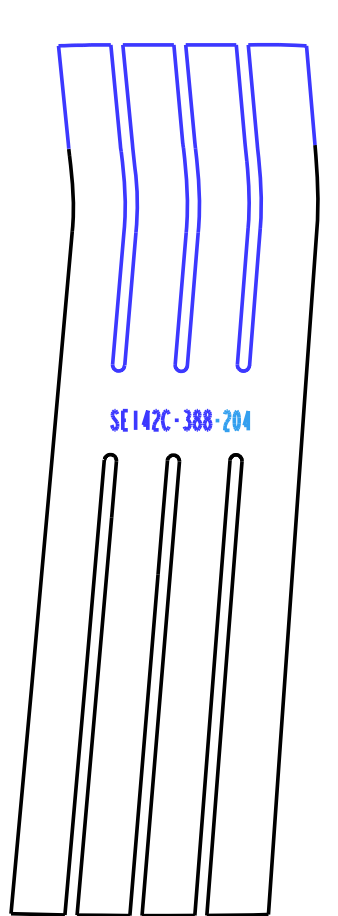

INSTANCE SE142C-388_FLAT_204

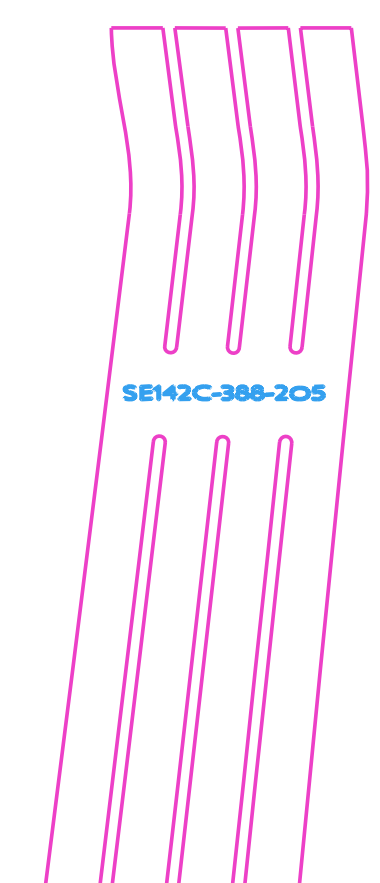

INSTANCE SE142C-388_FLAT_205

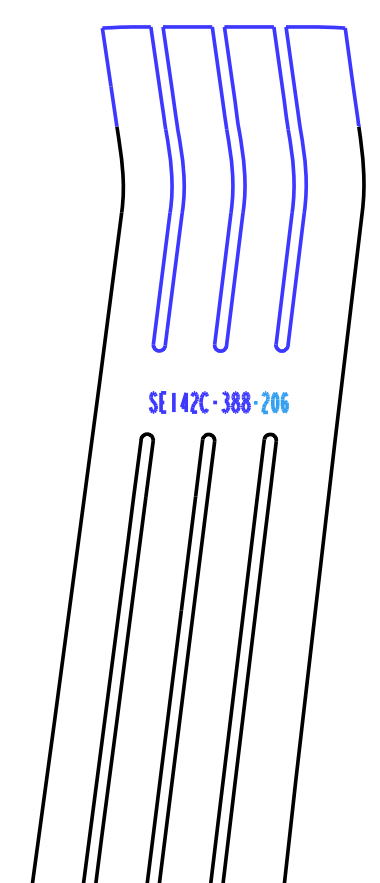

INSTANCE SE142C-388_FLAT_206

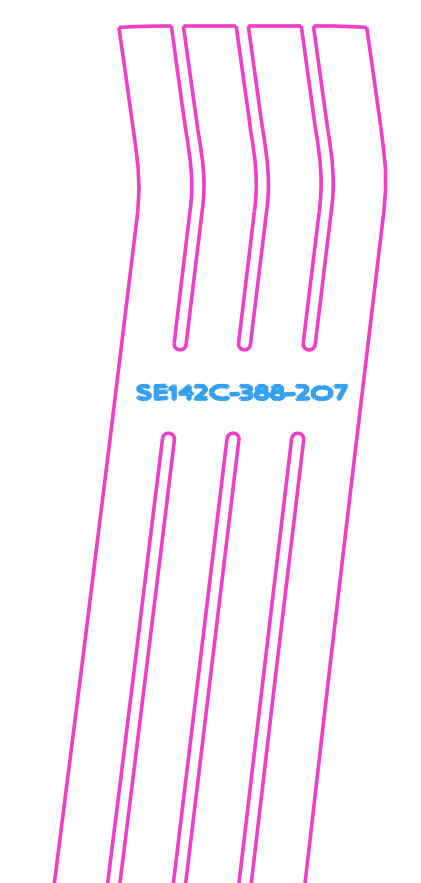

INSTANCE SE142C-388_FLAT_207

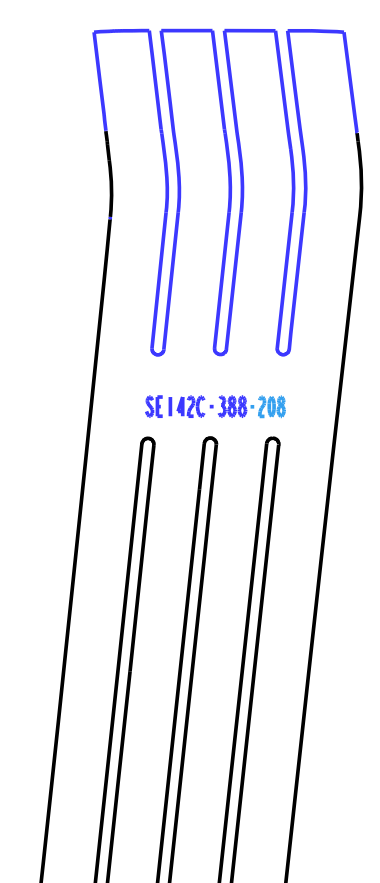

INSTANCE SE142C-388_FLAT_208

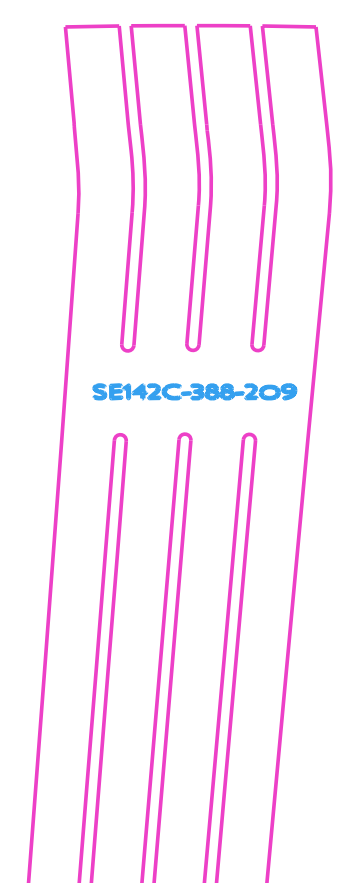

INSTANCE SE142C-388_FLAT_209

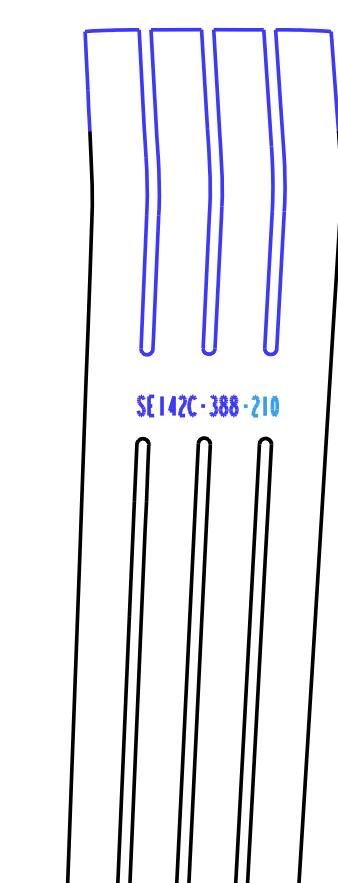

INSTANCE SE142C-388_FLAT_210

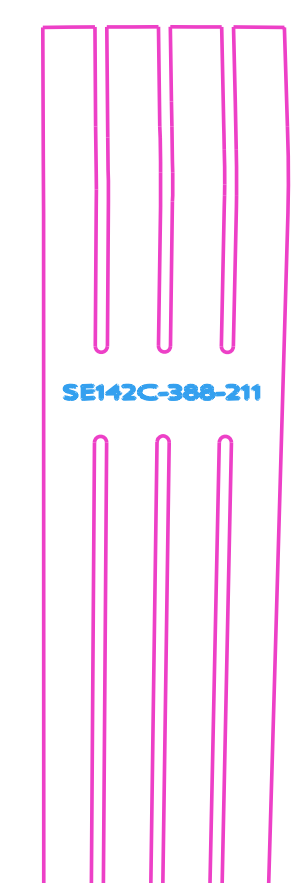

INSTANCE SE142C-388_FLAT_211

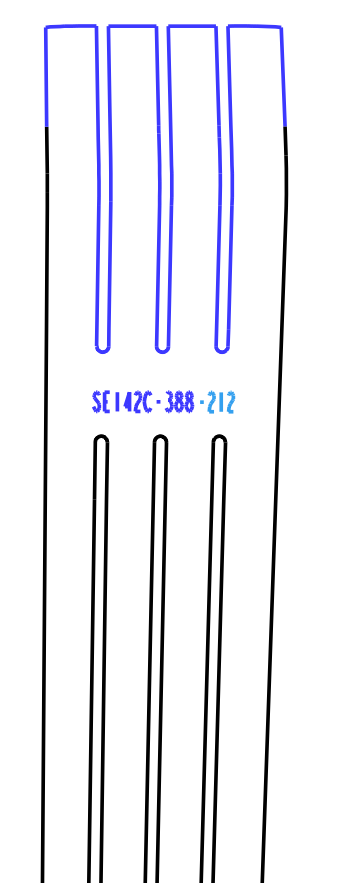

INSTANCE SE142C-388_FLAT_212

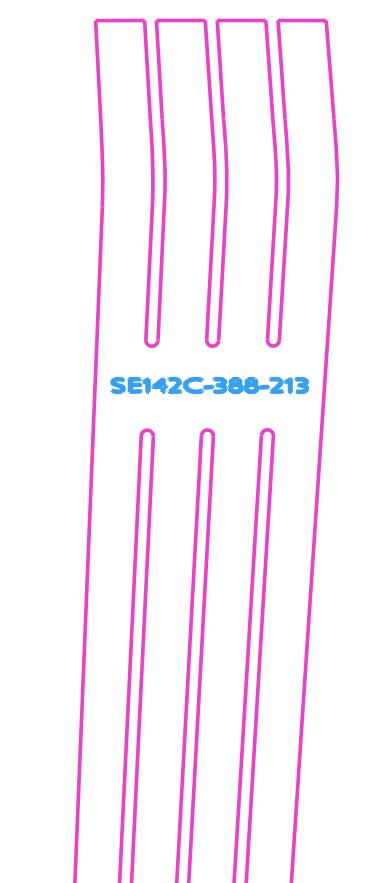

INSTANCE SE142C-388_FLAT_213

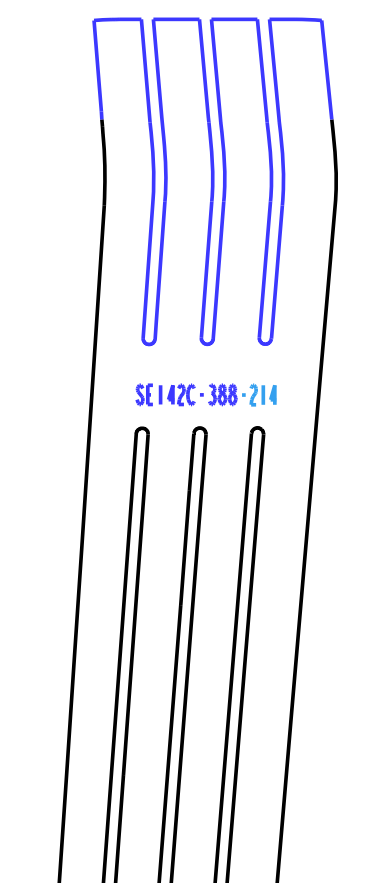

INSTANCE SE142C-388_FLAT_214

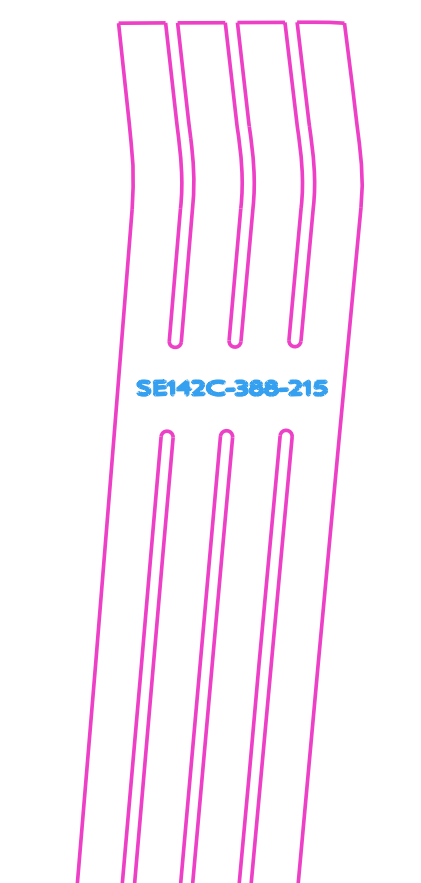

INSTANCE SE142C-388_FLAT_215

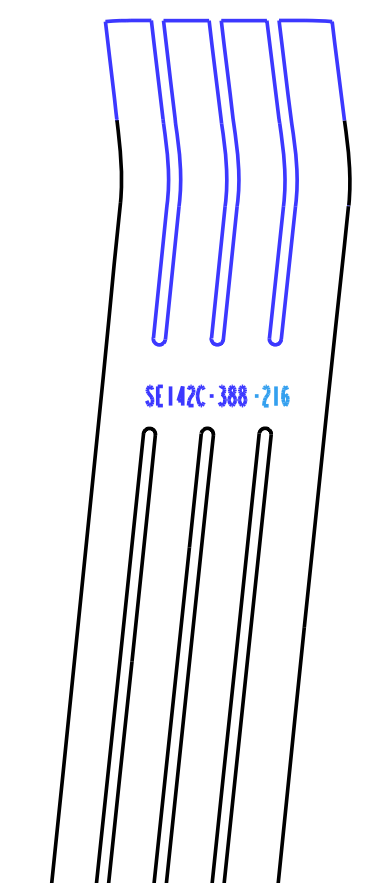

INSTANCE SE142C-388_FLAT_216

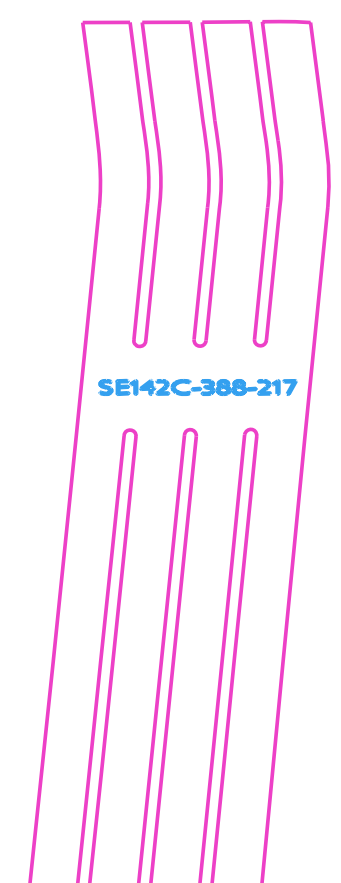

INSTANCE SE142C-388_FLAT_217

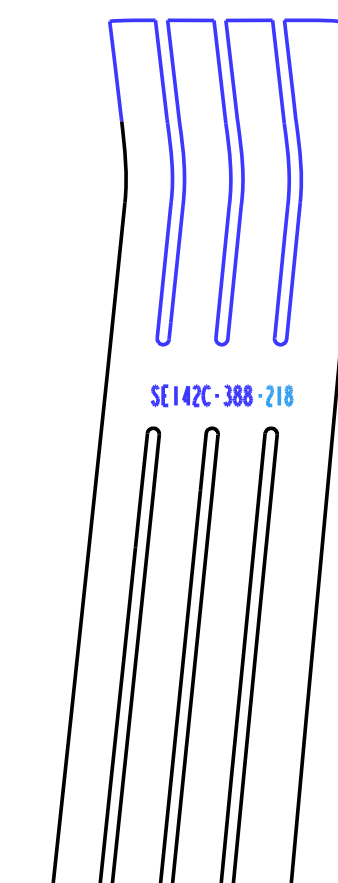

INSTANCE SE142C-388_FLAT_218



INSTANCE SE142C-388_FLAT_219

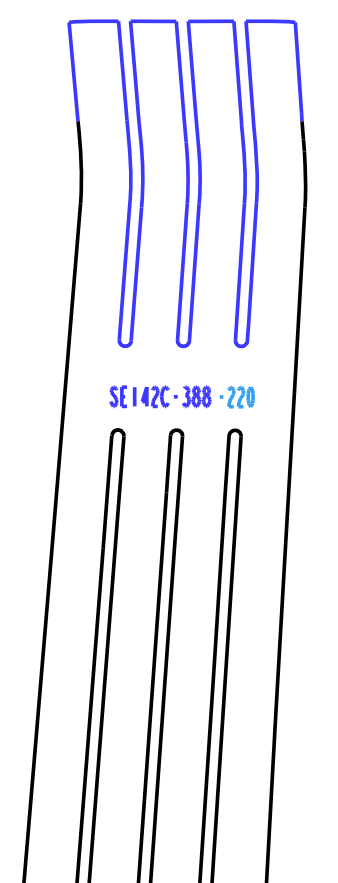

INSTANCE SE142C-388_FLAT_220

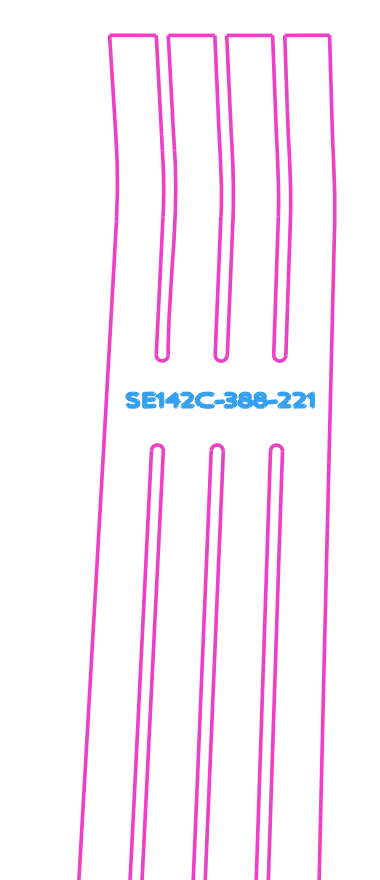

INSTANCE SE142C-388_FLAT_221

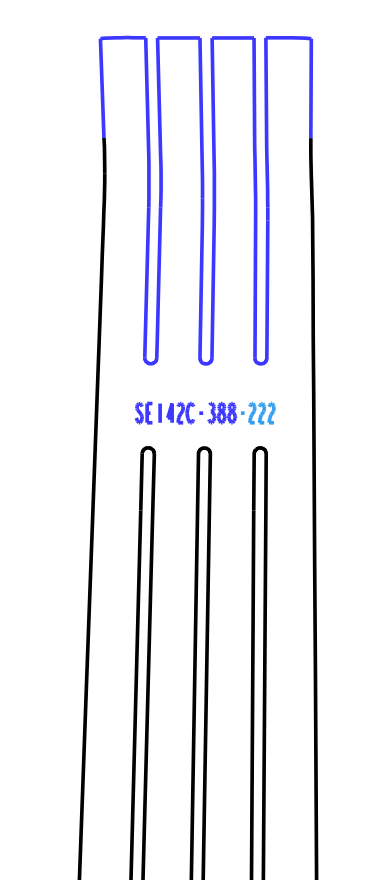

INSTANCE SE142C-388_FLAT_222

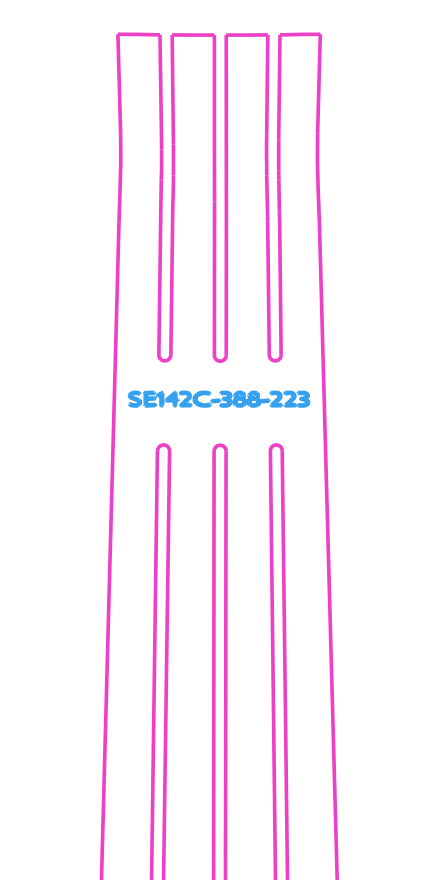

INSTANCE SE142C-388_FLAT_223

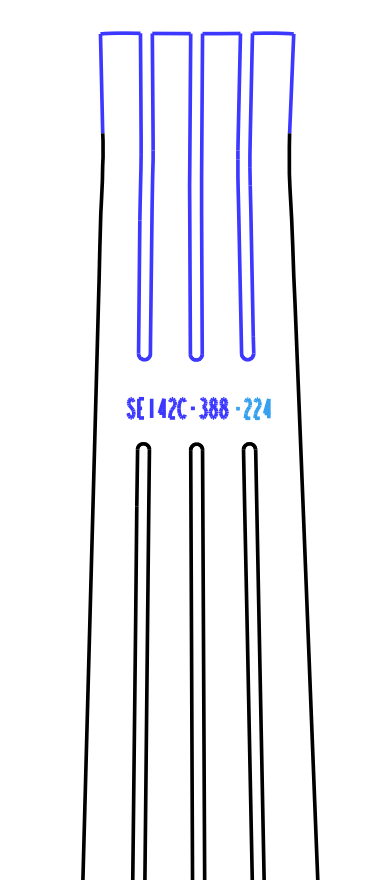

INSTANCE SE142C-388_FLAT_224

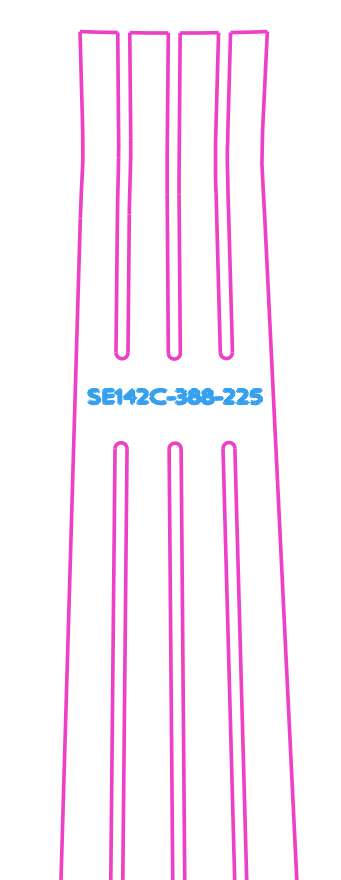

INSTANCE SE142C-388_FLAT_225

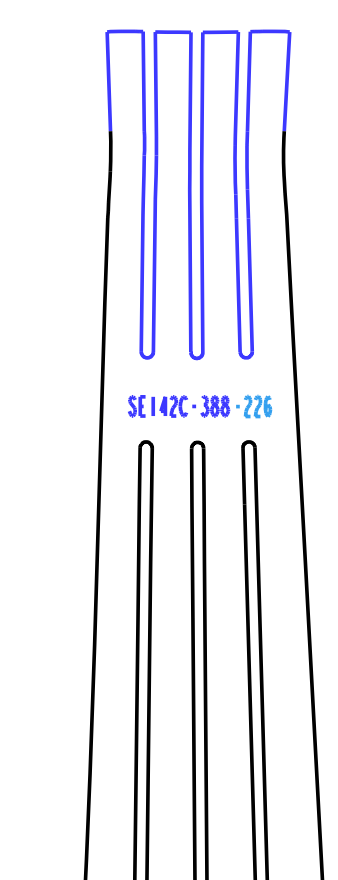

INSTANCE SE142C-388_FLAT_226

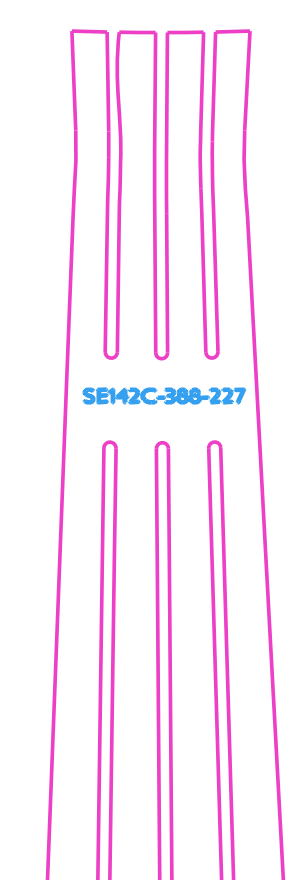

INSTANCE SE142C-388_FLAT_227

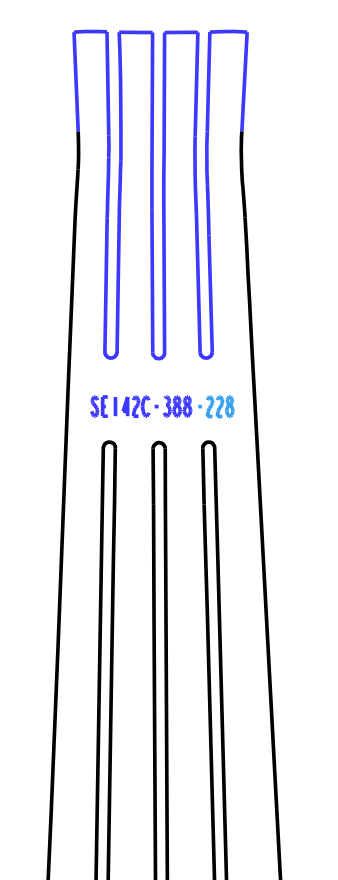

INSTANCE SE142C-388_FLAT_228

RELEASED FOR FABRICATION / INSTALLATION
PPPL Drafting:

Oak Ridge National Laboratory managed for the DEPARTMENT OF ENERGY under U.S. GOVERNMENT contract DE-AC05-00OR22725 UT-BATTELLE, LLC, Oak Ridge, Tennessee						
UT-BATTELLE						
NATIONAL COMPACT STELLARATOR EXPERIMENT						
MODULAR COIL TYPE - C SIDE "A" LOWER BOTTOM CHILL PLATE FLAT PATTERN LAYOUT						
VERSION NO.	PLANT	BLDG	FL	SHT OF	TYPE	CLASS
1	X-10	5700	3	5	7	S
RELEASE LEVEL		Fabrication		SE142C-388		REV 0

SE142C-388

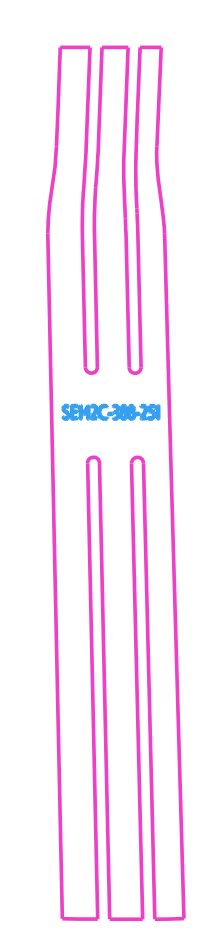

INSTANCE SE142C-388_FLAT_NEW_251

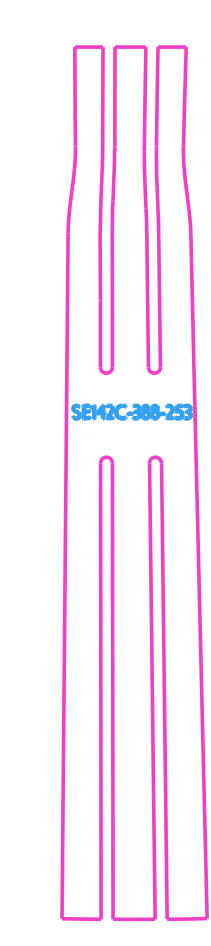

INSTANCE SE142C-388_FLAT_NEW_253

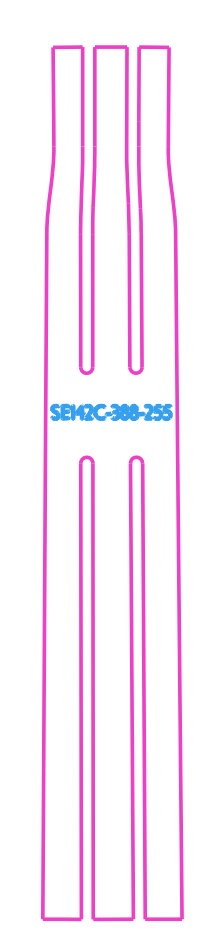

INSTANCE SE142C-388_FLAT_NEW_255

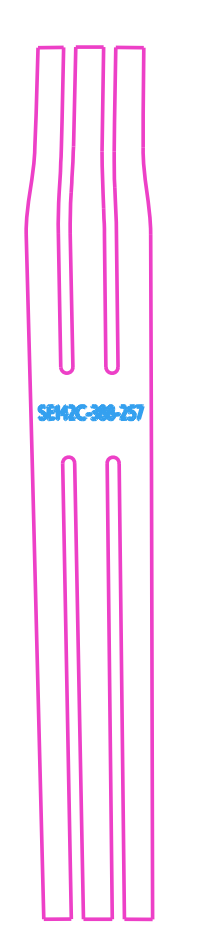

INSTANCE SE142C-388_FLAT_NEW_257

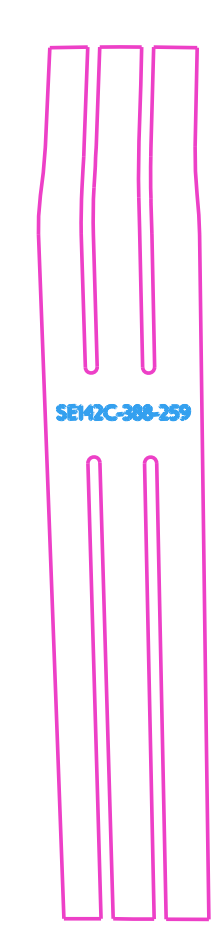

INSTANCE SE142C-388_FLAT_NEW_259

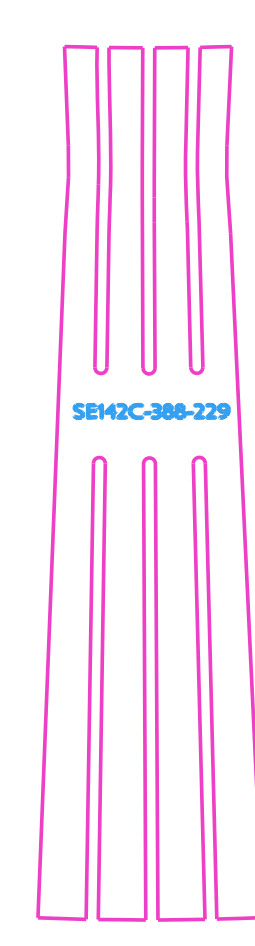

INSTANCE SE142C-388_FLAT_229

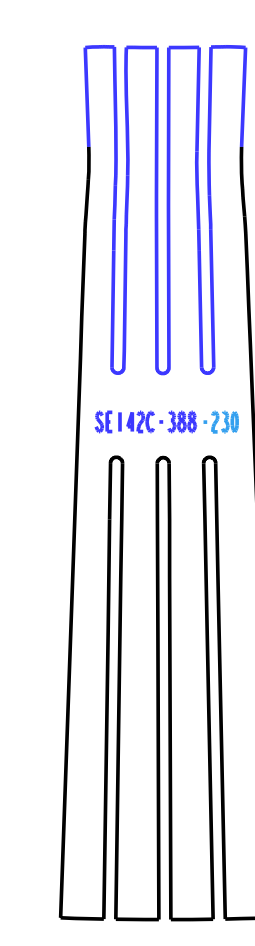

INSTANCE SE142C-388_FLAT_230

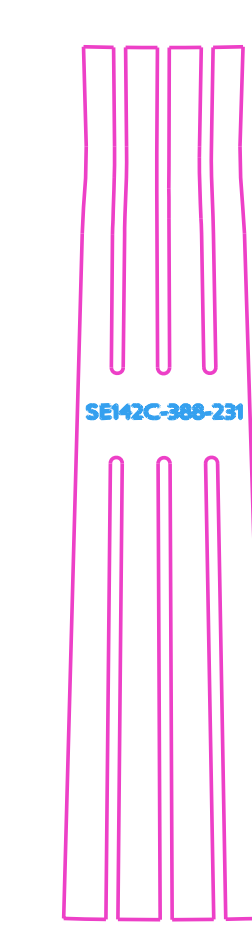

INSTANCE SE142C-388_FLAT_231

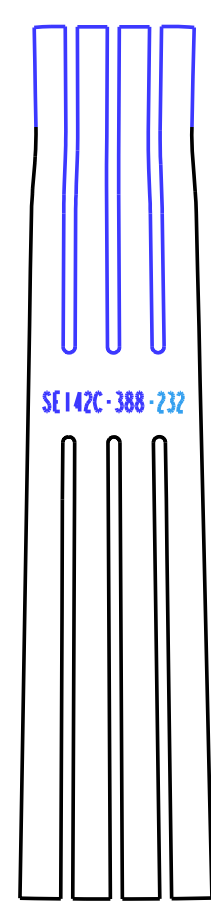

INSTANCE SE142C-388_FLAT_232

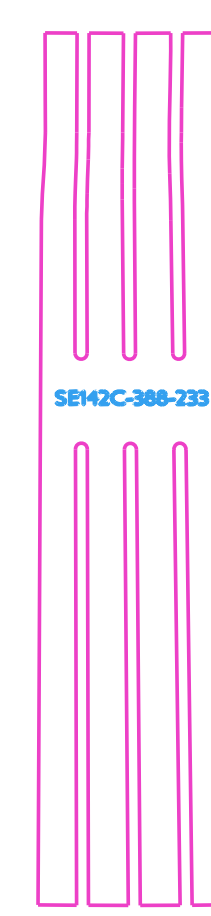

INSTANCE SE142C-388_FLAT_233

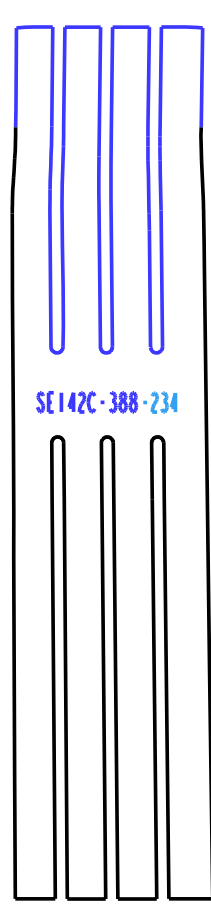

INSTANCE SE142C-388_FLAT_234

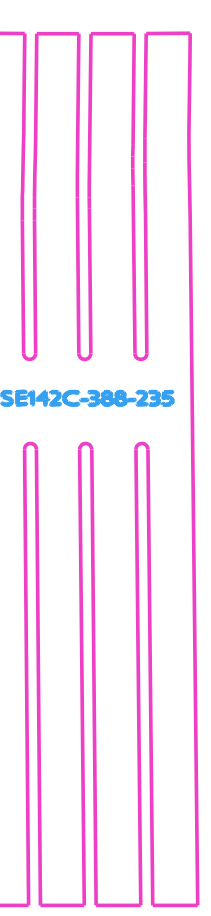

INSTANCE SE142C-388_FLAT_235

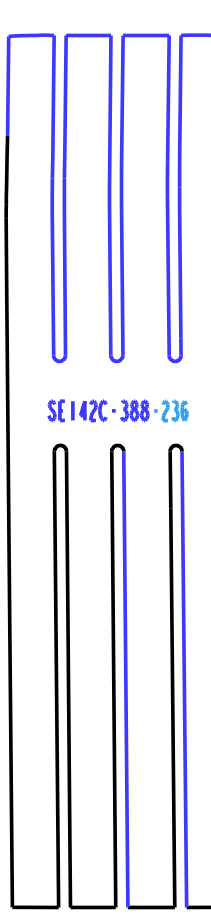

INSTANCE SE142C-388_FLAT_236

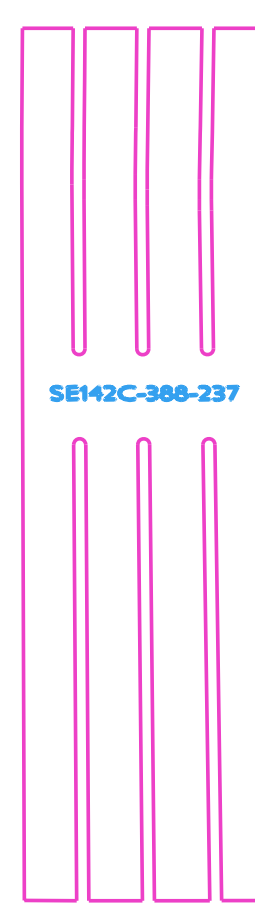

INSTANCE SE142C-388_FLAT_237

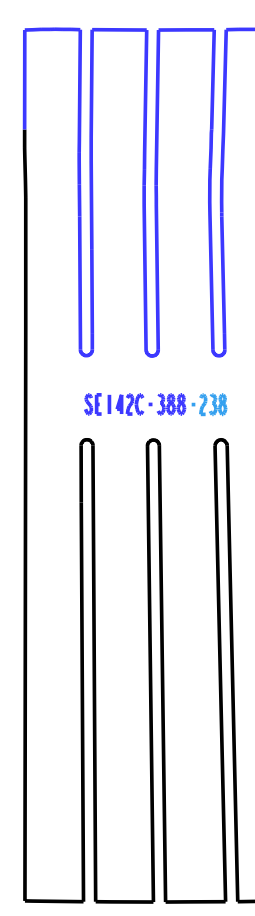

INSTANCE SE142C-388_FLAT_238

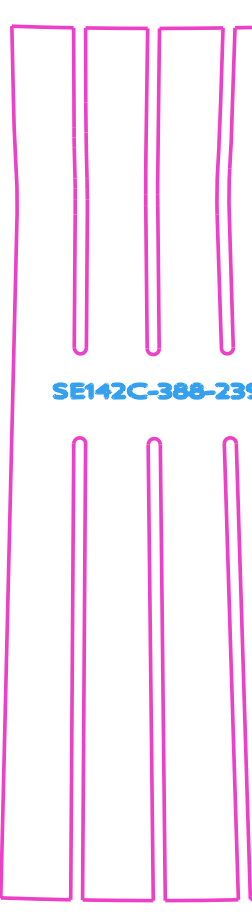

INSTANCE SE142C-388_FLAT_239

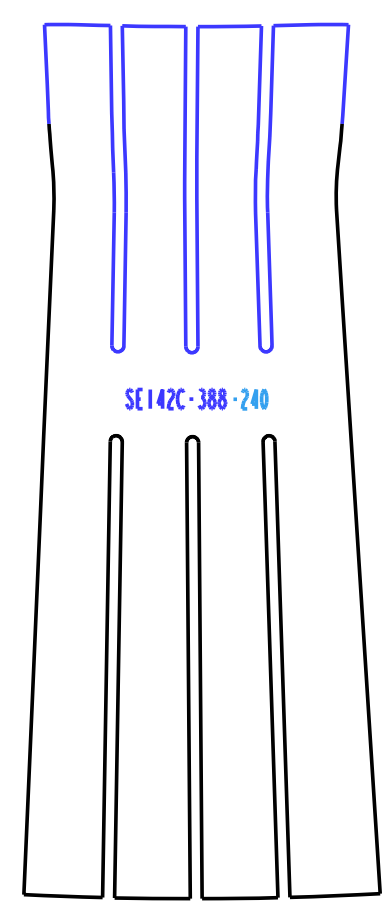

INSTANCE SE142C-388_FLAT_240

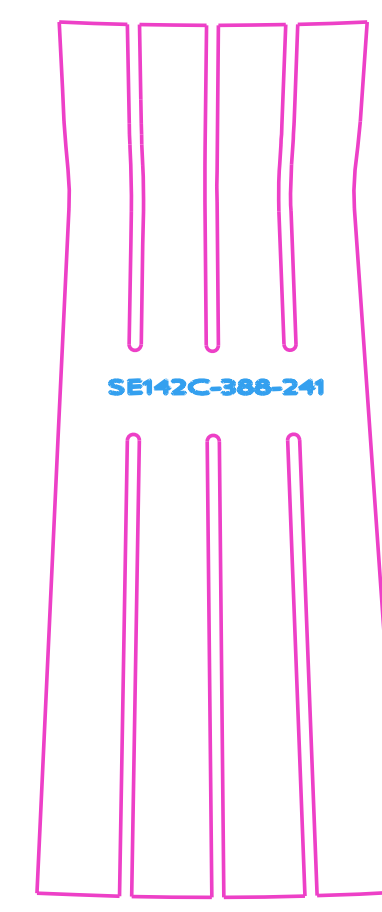

INSTANCE SE142C-388_FLAT_241

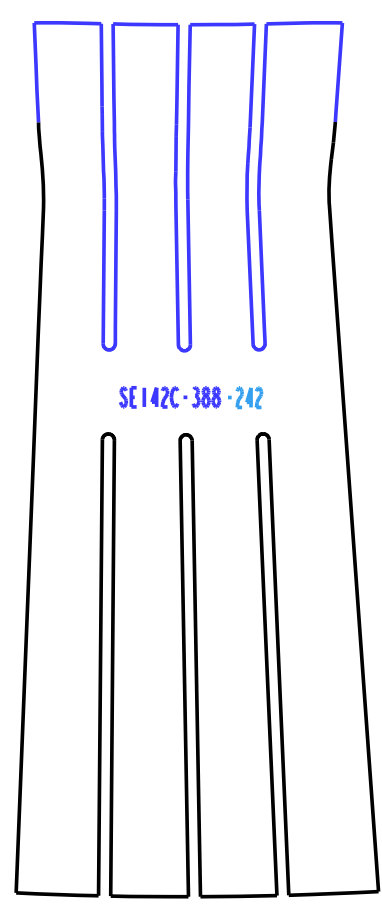

INSTANCE SE142C-388_FLAT_242

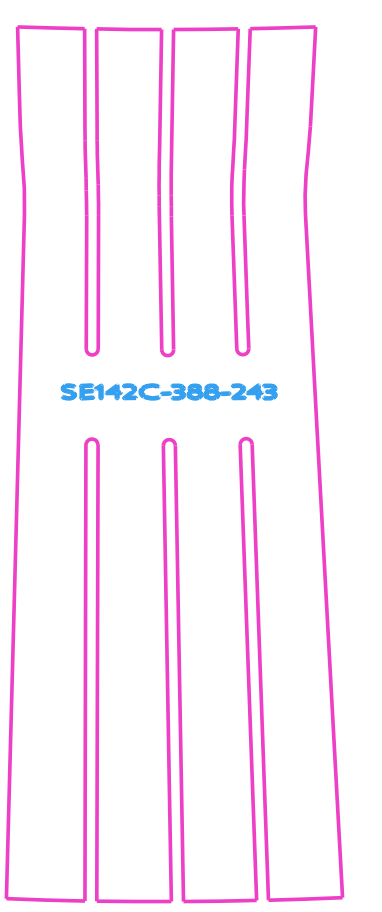

INSTANCE SE142C-388_FLAT_243

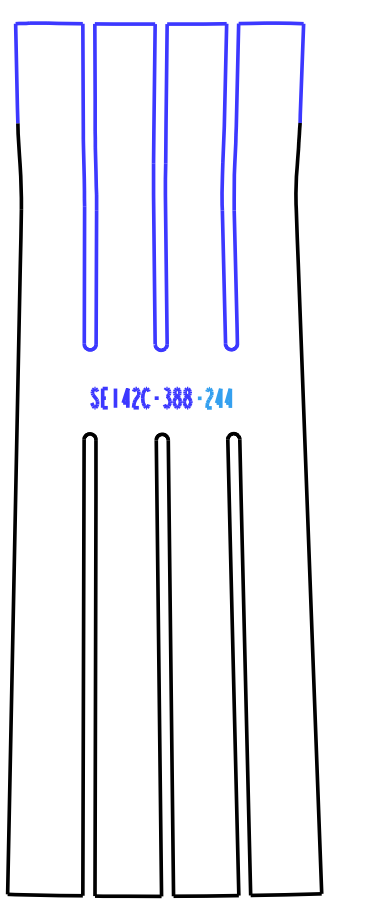

INSTANCE SE142C-388_FLAT_244

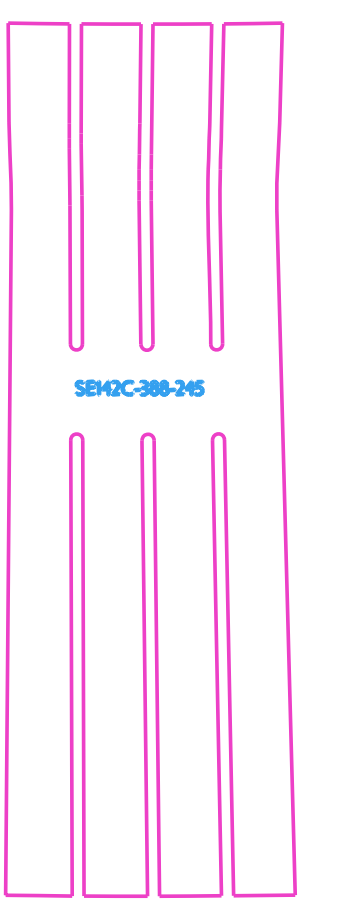

INSTANCE SE142C-388_FLAT_245

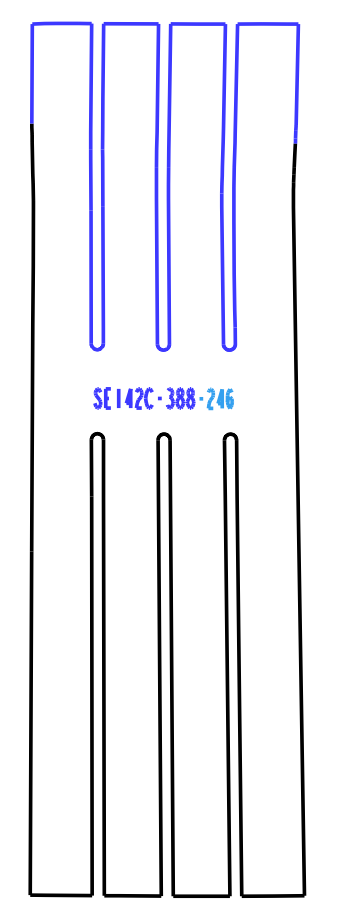

INSTANCE SE142C-388_FLAT_246

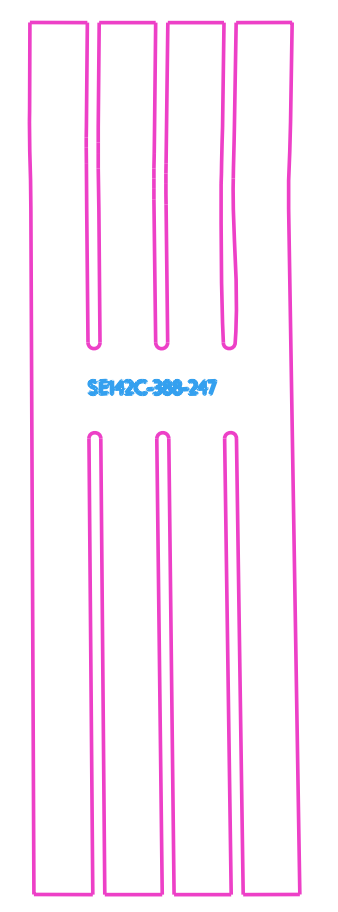

INSTANCE SE142C-388_FLAT_247

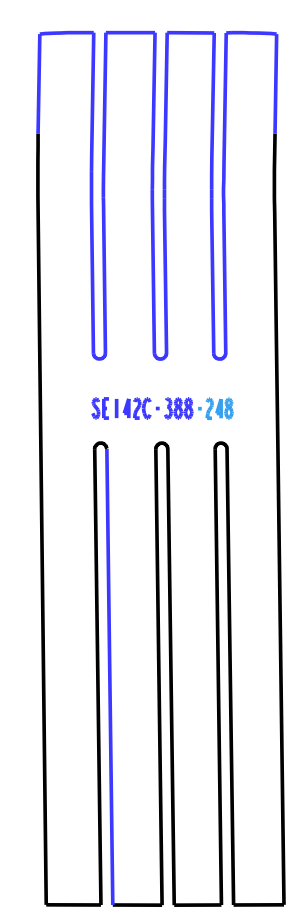

INSTANCE SE142C-388_FLAT_248

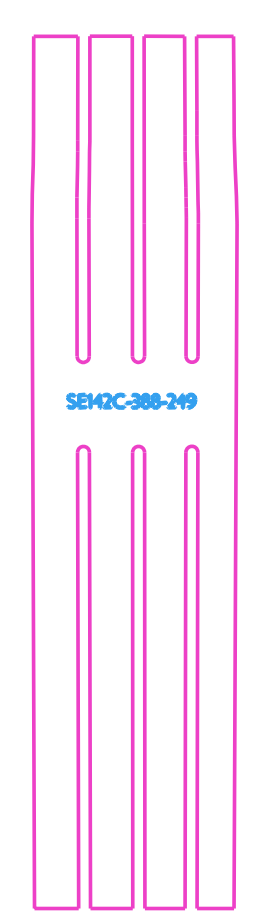

INSTANCE SE142C-388_FLAT_249

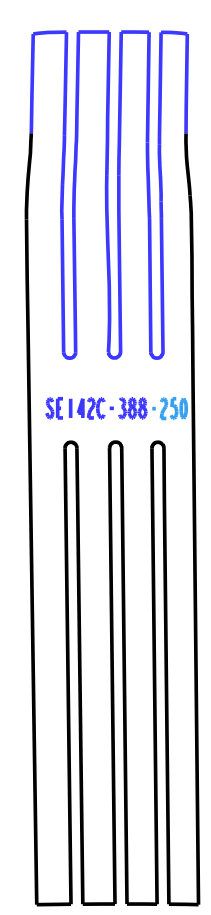

INSTANCE SE142C-388_FLAT_250

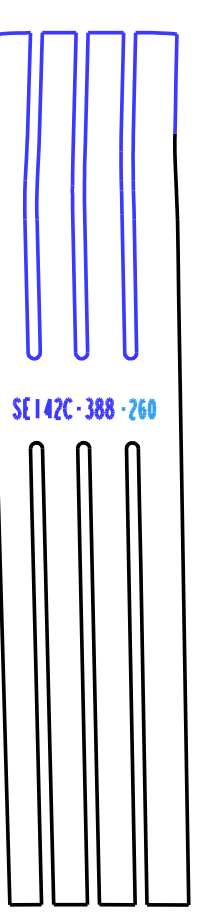

INSTANCE SE142C-388_FLAT_260

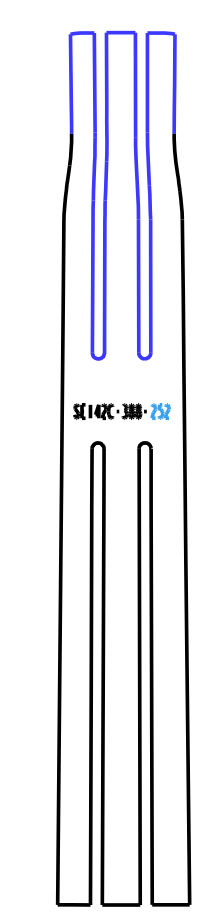

INSTANCE SE142C-388_FLAT_NEW_252

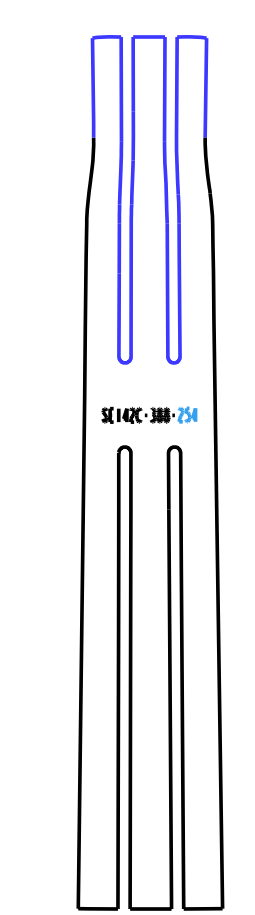

INSTANCE SE142C-388_FLAT_NEW_254

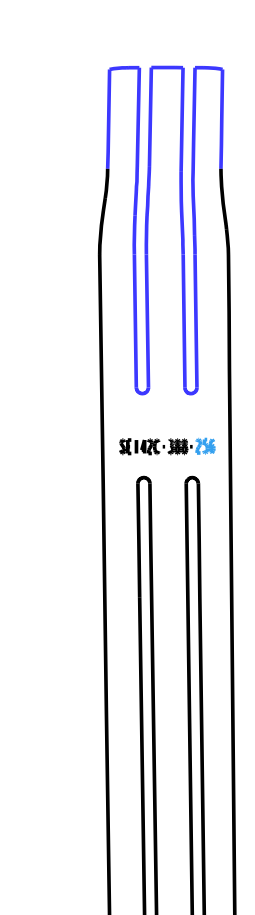

INSTANCE SE142C-388_FLAT_NEW_256

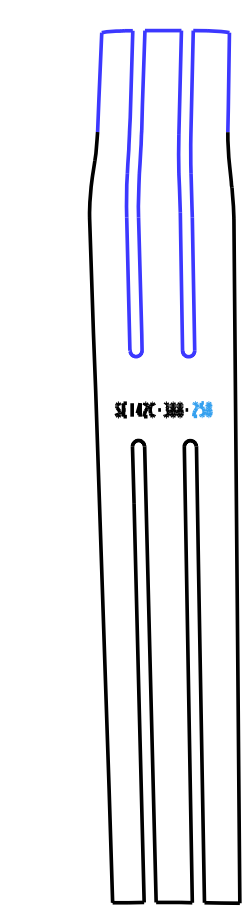

INSTANCE SE142C-388_FLAT_NEW_258

RELEASED FOR FABRICATION / INSTALLATION PPPL Drafting:

Oak Ridge National Laboratory managed for the DEPARTMENT OF ENERGY under U.S. GOVERNMENT contract DE-AC05-00OR22725 UT-BATTELLE, LLC, Oak Ridge, Tennessee						
UT-BATTELLE NATIONAL COMPACT STELLARATOR EXPERIMENT MODULAR COIL TYPE - C SIDE "A" LOWER BOTTOM CHILL PLATE FLAT PATTERN LAYOUT						
VERSION NO.	PLANT	BLDG	FL	SHT OF	TYPE	CLASS
1	X-10	5700	3	6	7	S
RELEASE LEVEL		Fabrication		SE142C-388		REV 0

SE142C-388

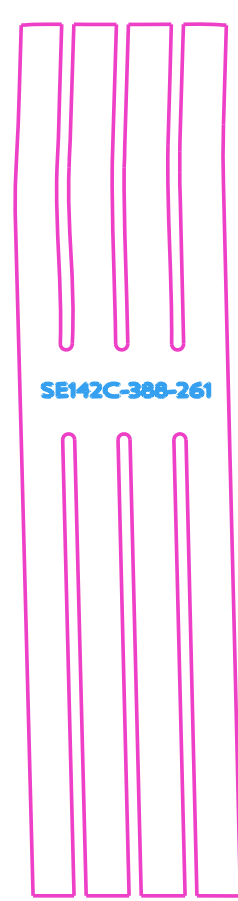

INSTANCE SE142C-388_FLAT_261

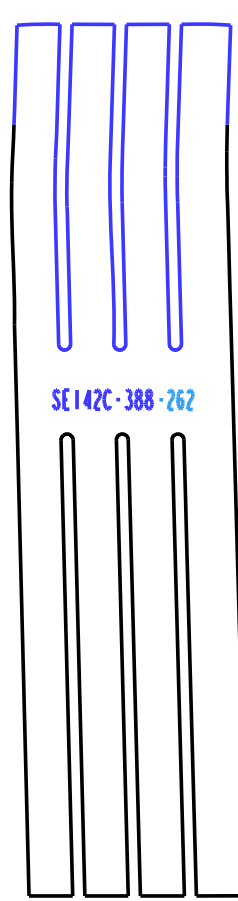

INSTANCE SE142C-388_FLAT_262

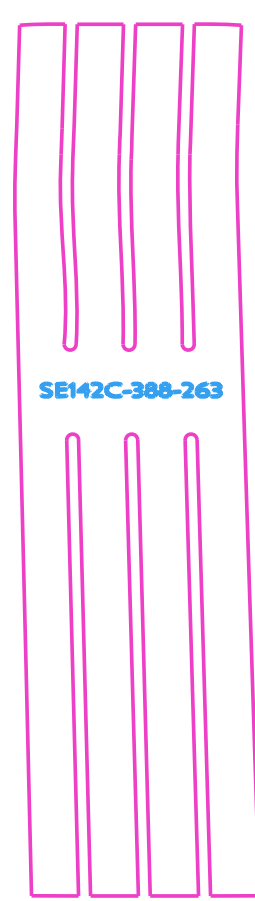

INSTANCE SE142C-388_FLAT_263

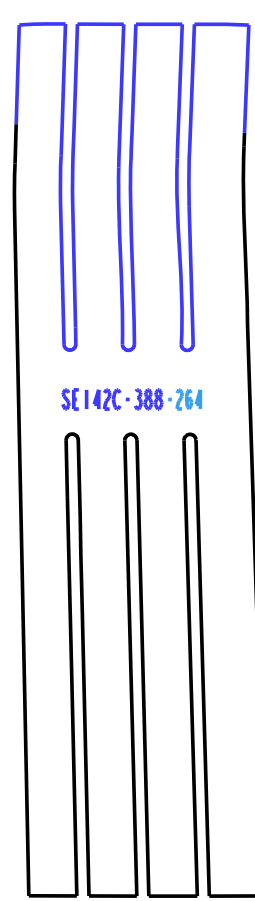

INSTANCE SE142C-388_FLAT_264

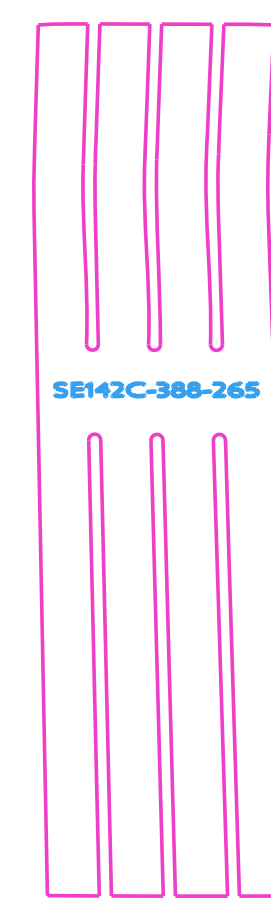

INSTANCE SE142C-388_FLAT_265

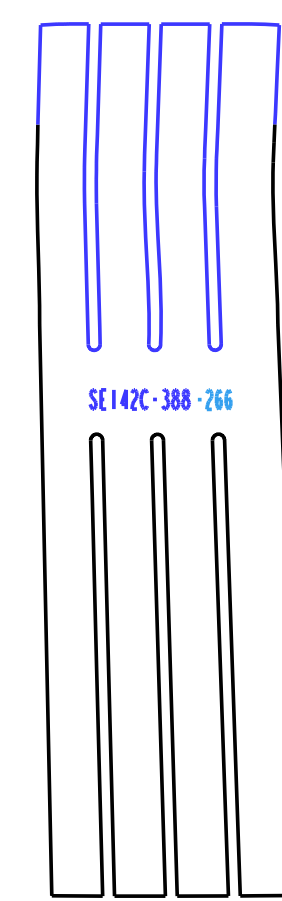

INSTANCE SE142C-388_FLAT_266

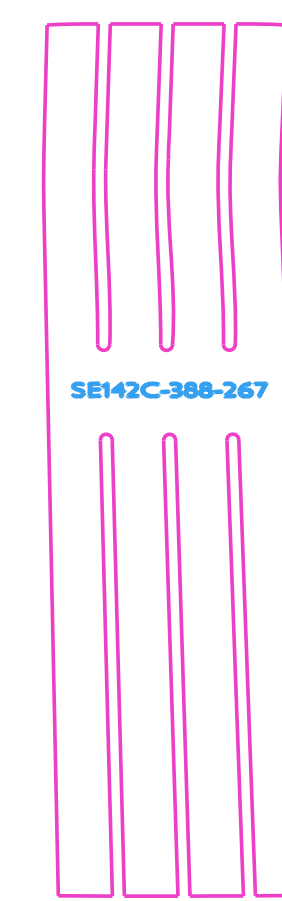

INSTANCE SE142C-388_FLAT_267

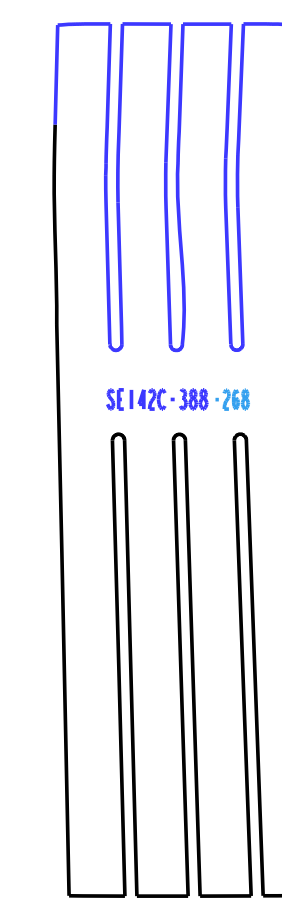

INSTANCE SE142C-388_FLAT_268

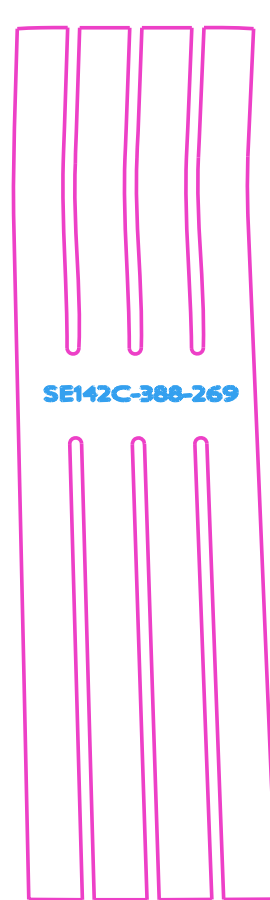

INSTANCE SE142C-388_FLAT_269

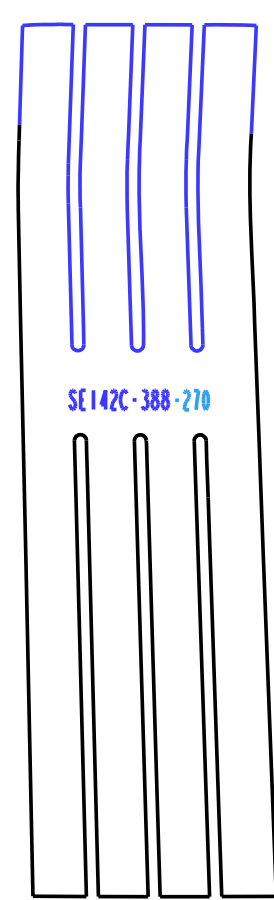

INSTANCE SE142C-388_FLAT_270

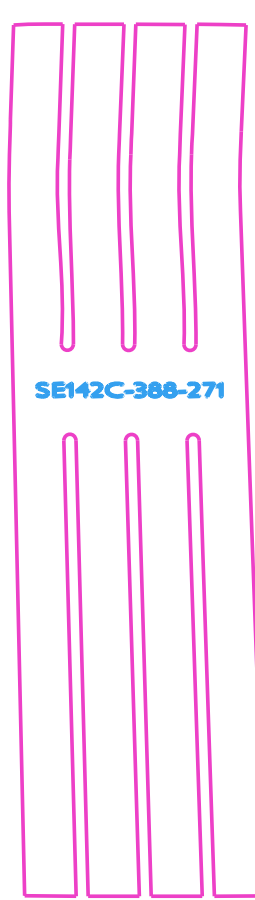

INSTANCE SE142C-388_FLAT_271

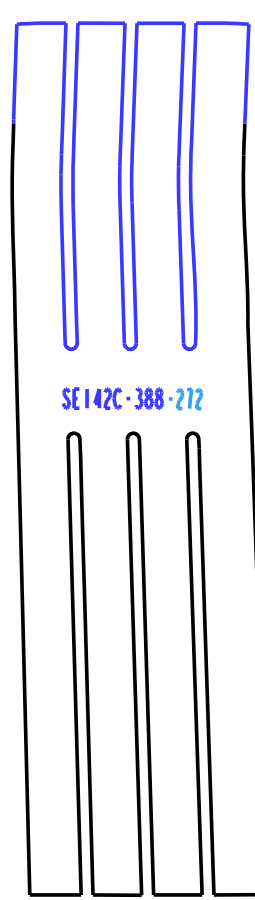

INSTANCE SE142C-388_FLAT_272

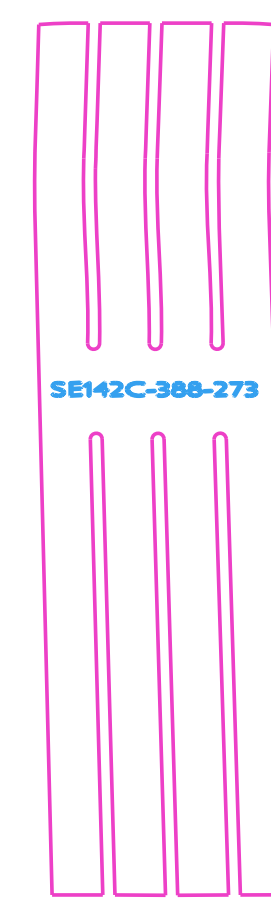

INSTANCE SE142C-388_FLAT_273

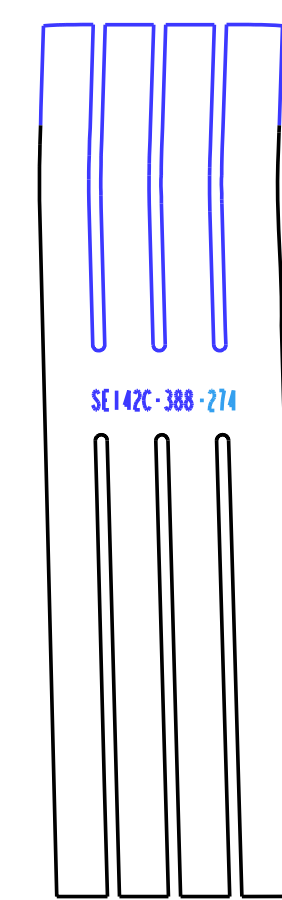

INSTANCE SE142C-388_FLAT_274

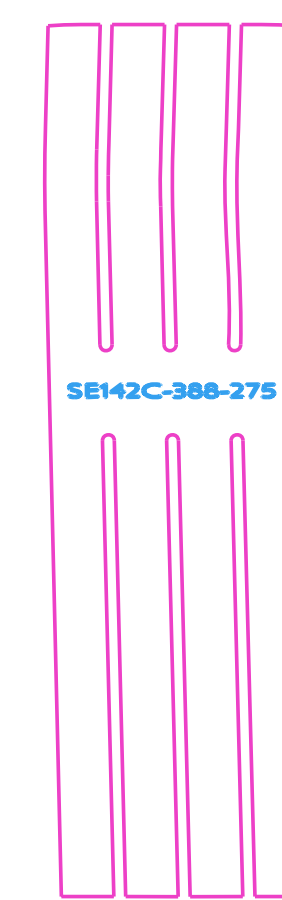

INSTANCE SE142C-388_FLAT_275

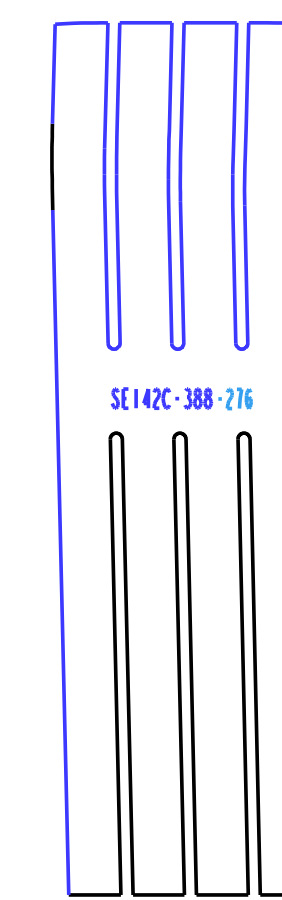

INSTANCE SE142C-388_FLAT_276

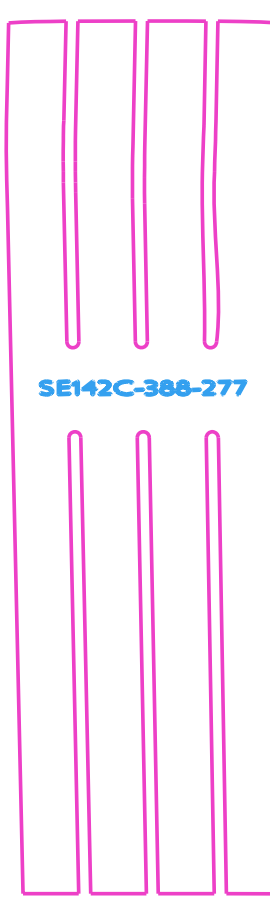

INSTANCE SE142C-388_FLAT_277

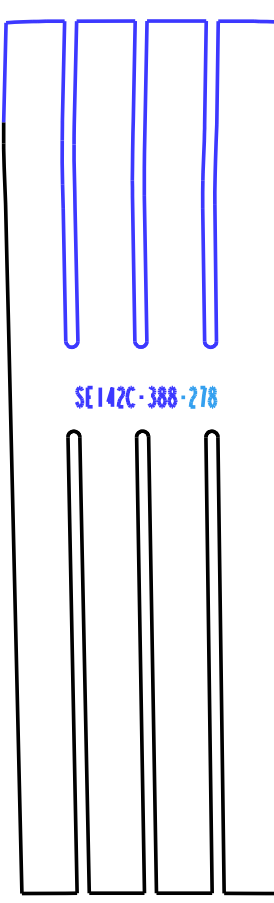

INSTANCE SE142C-388_FLAT_278



INSTANCE SE142C-388_FLAT_279

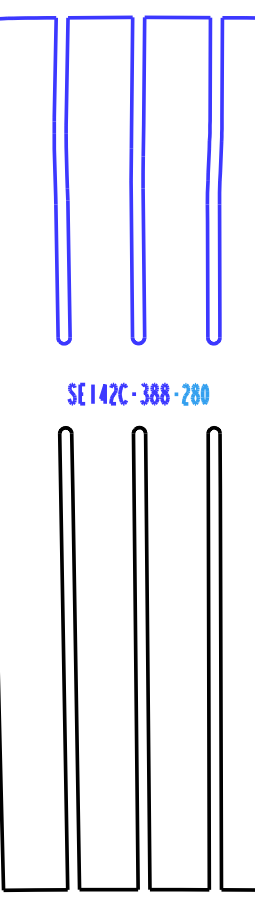

INSTANCE SE142C-388_FLAT_280

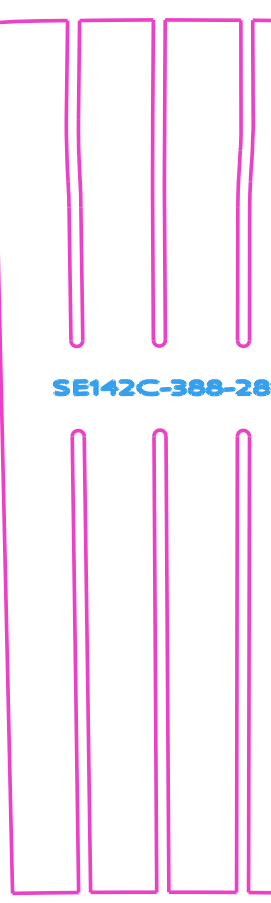

INSTANCE SE142C-388_FLAT_281

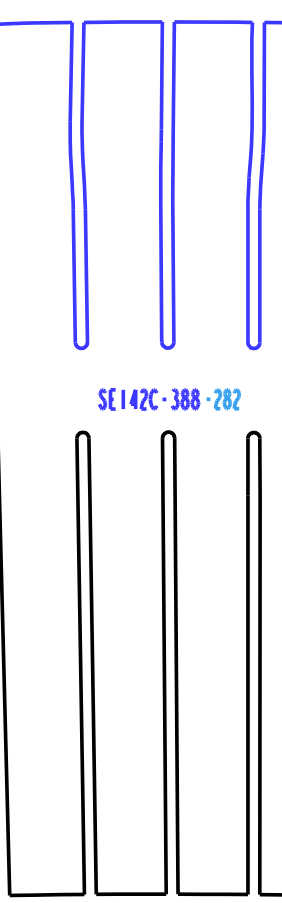

INSTANCE SE142C-388_FLAT_282

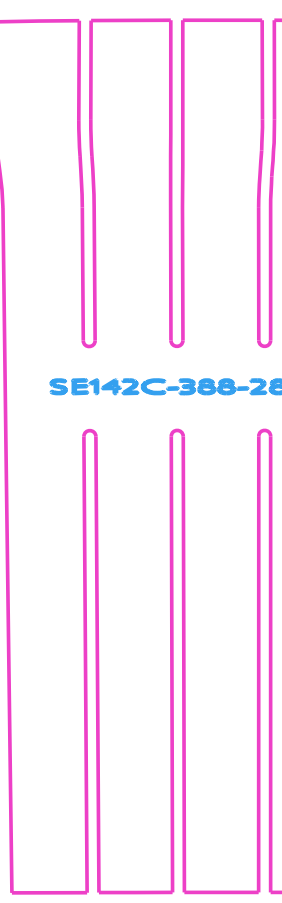

INSTANCE SE142C-388_FLAT_283

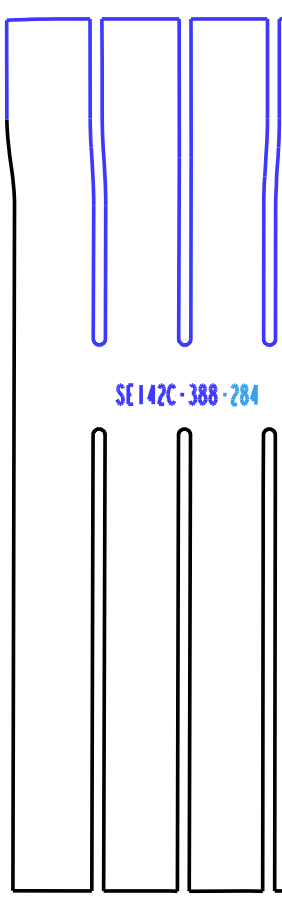

INSTANCE SE142C-388_FLAT_284

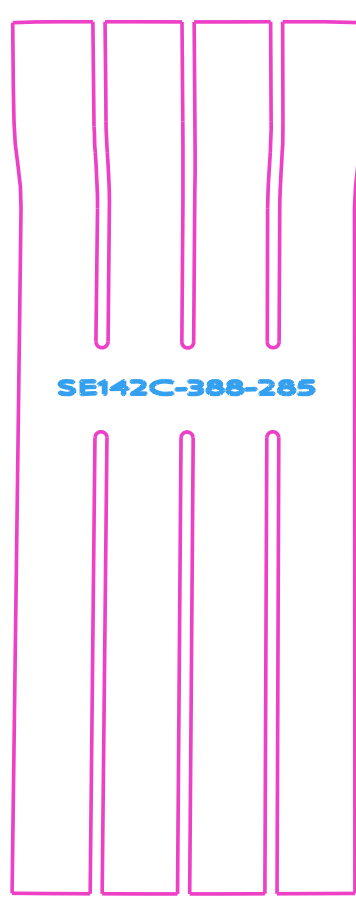

INSTANCE SE142C-388_FLAT_285

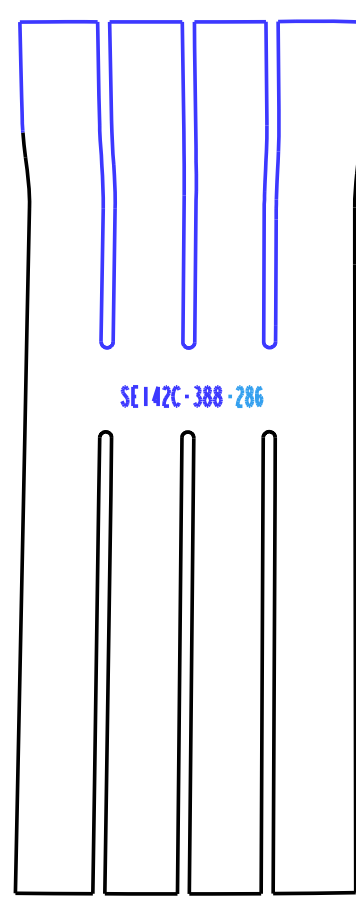

INSTANCE SE142C-388_FLAT_286

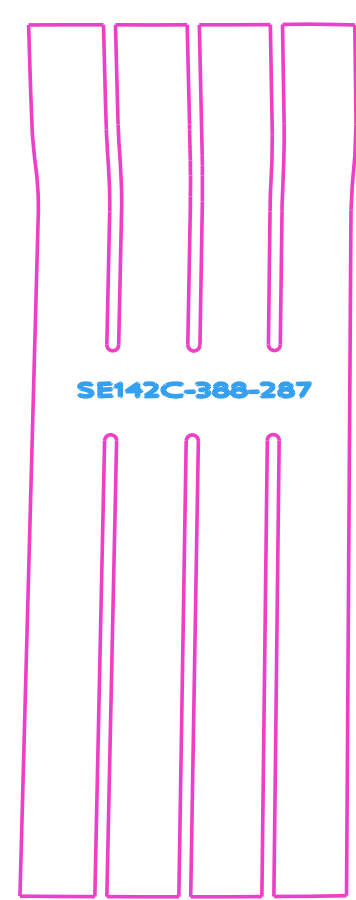

INSTANCE SE142C-388_FLAT_287

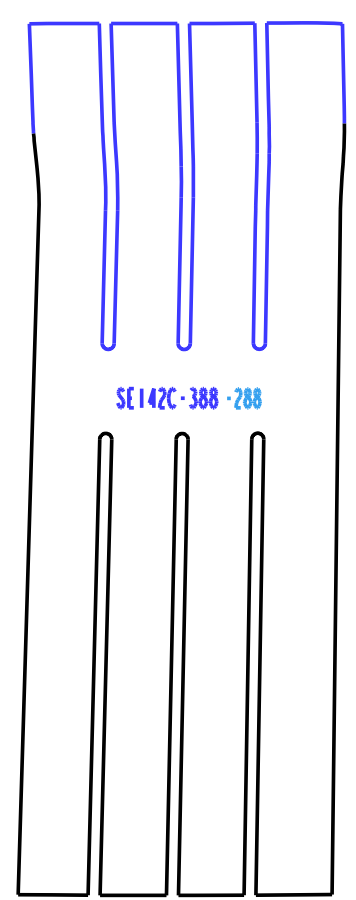

INSTANCE SE142C-388_FLAT_288

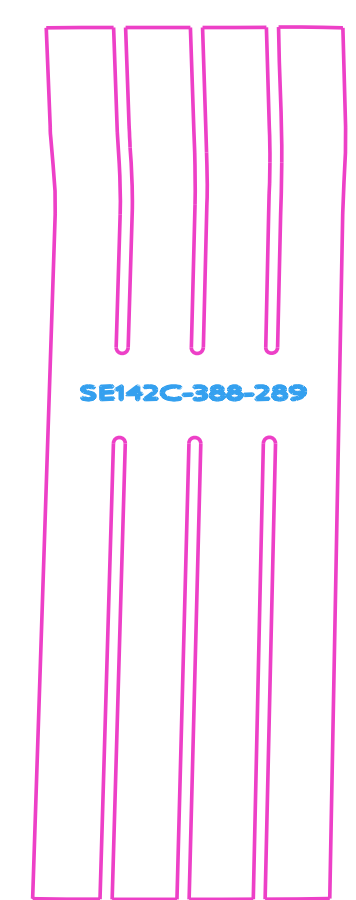

INSTANCE SE142C-388_FLAT_289

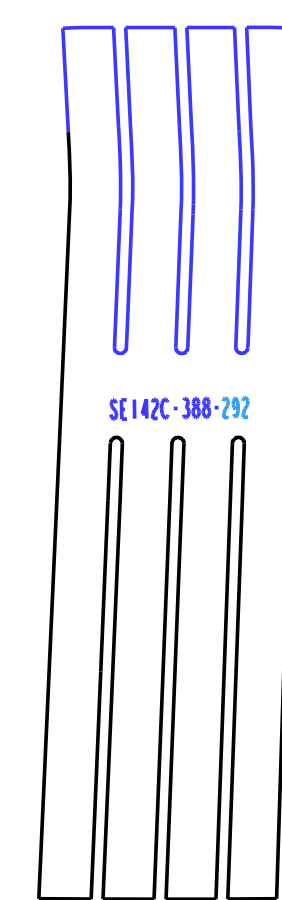

INSTANCE SE142C-388_FLAT_290_NEW

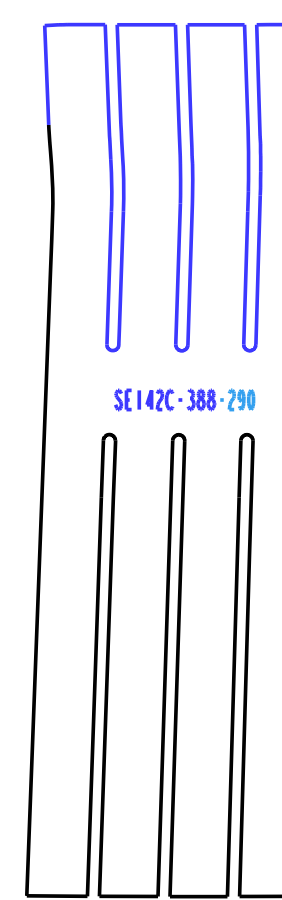

INSTANCE SE142C-388_FLAT_290



INSTANCE SE142C-388_FLAT_291

RELEASED FOR FABRICATION / INSTALLATION
PPPL Drafting:

Oak Ridge National Laboratory managed for the DEPARTMENT OF ENERGY under U.S. GOVERNMENT contract DE-AC05-00OR22725 UT-BATTELLE, LLC, Oak Ridge, Tennessee						
UT-BATTELLE						
NATIONAL COMPACT STELLARATOR EXPERIMENT						
MODULAR COIL TYPE - C SIDE "A" LOWER BOTTOM CHILL PLATE FLAT PATTERN LAYOUT						
VERSION NO.	PLANT	BLDG	FL	SHT OF	TYPE	CLASS
2	X-10	5700	3	7	S	U
RELEASE LEVEL		SE142C-388		REV		0
Fabrication						

SE142C-388