

- NOTES
- DRAWING PREPARED IN ACCORDANCE WITH ASME Y14.100-2000.
 - INTERPRET DIMENSIONS AND TOLERANCES PER ANSI Y14.5M-1994.
 - DIMENSIONS ARE IN INCHES.
 - DRAWING DEPICTS FLAT PATTERN OF FORMED PARTS DEFINED BY PRO/ENGINEER FILES SEI42C-486-XXX.PRT.
 - PROFILE TOLERANCE OF FLAT PATTERN IS +/- .010 IN.
 - THICKNESS IS 0.040 +/- .006 IN. PER ASTM B248.
 - REMOVE ALL BURRS AND SHARP EDGES.
 - IDENTIFY PARTS WITH "PART NAME" BY ETCHING OR PERMANENT MARKER.

INSTANCE NAME	HOLE	S-DIM	PART NAME	INSTANCE NAME	HOLE	S-DIM	PART NAME
SEI42C-486-FLAT_270		0.8854170	SEI42C-486-270	SEI42C-486-FLAT_174-NEW		0.3854170	SEI42C-486-174
SEI42C-486-FLAT_271	1	0.8906250	SEI42C-486-271	SEI42C-486-FLAT_175-NEW	49	0.3906250	SEI42C-486-175
SEI42C-486-FLAT_272		0.8958330	SEI42C-486-272	SEI42C-486-FLAT_176-NEW		0.3958330	SEI42C-486-176
SEI42C-486-FLAT_273	2	0.9010420	SEI42C-486-273	SEI42C-486-FLAT_177-NEW	50	0.4010420	SEI42C-486-177
SEI42C-486-FLAT_274		0.9062500	SEI42C-486-274	SEI42C-486-FLAT_178		0.4062500	SEI42C-486-178
SEI42C-486-FLAT_275	3	0.9114580	SEI42C-486-275	SEI42C-486-FLAT_179	51	0.4114580	SEI42C-486-179
SEI42C-486-FLAT_276		0.9166670	SEI42C-486-276	SEI42C-486-FLAT_180		0.4166670	SEI42C-486-180
SEI42C-486-FLAT_277	4	0.9218750	SEI42C-486-277	SEI42C-486-FLAT_181	52	0.4218750	SEI42C-486-181
SEI42C-486-FLAT_278		0.9270830	SEI42C-486-278	SEI42C-486-FLAT_182		0.4270830	SEI42C-486-182
SEI42C-486-FLAT_279	5	0.9322920	SEI42C-486-279	SEI42C-486-FLAT_183	53	0.4322920	SEI42C-486-183
SEI42C-486-FLAT_280		0.9375000	SEI42C-486-280	SEI42C-486-FLAT_184		0.4375000	SEI42C-486-184
SEI42C-486-FLAT_281	6	0.9427080	SEI42C-486-281	SEI42C-486-FLAT_185	54	0.4427080	SEI42C-486-185
SEI42C-486-FLAT_282		0.9479170	SEI42C-486-282	SEI42C-486-FLAT_186		0.4479170	SEI42C-486-186
SEI42C-486-FLAT_283	7	0.9531250	SEI42C-486-283	SEI42C-486-FLAT_187	55	0.4531250	SEI42C-486-187
SEI42C-486-FLAT_284		0.9583330	SEI42C-486-284	SEI42C-486-FLAT_188		0.4583330	SEI42C-486-188
SEI42C-486-FLAT_285	8	0.9635420	SEI42C-486-285	SEI42C-486-FLAT_189	56	0.4635420	SEI42C-486-189
SEI42C-486-FLAT_286		0.9687500	SEI42C-486-286	SEI42C-486-FLAT_190		0.4687500	SEI42C-486-190
SEI42C-486-FLAT_287	9	0.9739580	SEI42C-486-287	SEI42C-486-FLAT_191	57	0.4739580	SEI42C-486-191
SEI42C-486-FLAT_288		0.9791670	SEI42C-486-288	SEI42C-486-FLAT_192		0.4791670	SEI42C-486-192
SEI42C-486-FLAT_289	10	0.9843750	SEI42C-486-289	SEI42C-486-FLAT_193	58	0.4843750	SEI42C-486-193
SEI42C-486-FLAT_290		0.9895830	SEI42C-486-290	SEI42C-486-FLAT_194		0.4895830	SEI42C-486-194
SEI42C-486-FLAT_291	11	0.9947920	SEI42C-486-291	SEI42C-486-FLAT_195-NEW	59	0.4947920	SEI42C-486-195
SEI42C-486-FLAT_292-NEW		0.0000000	SEI42C-486-292	SEI42C-486-FLAT_196		0.5000000	SEI42C-486-196
SEI42C-486-FLAT_101	12	0.0052080	SEI42C-486-101	SEI42C-486-FLAT_197	60	0.5052080	SEI42C-486-197
SEI42C-486-FLAT_102		0.0104170	SEI42C-486-102	SEI42C-486-FLAT_198-NEW		0.5104170	SEI42C-486-198
SEI42C-486-FLAT_103-NEW	13	0.0156250	SEI42C-486-103	SEI42C-486-FLAT_199-NEW	61	0.5156250	SEI42C-486-199
SEI42C-486-FLAT_104-NEW		0.0193410	SEI42C-486-104	SEI42C-486-FLAT_200-NEW		0.5208330	SEI42C-486-200
SEI42C-486-FLAT_106-NEW	14	0.0240000	SEI42C-486-106	SEI42C-486-FLAT_201	62	0.5260420	SEI42C-486-201
SEI42C-486-FLAT_107-NEW		0.0360000	SEI42C-486-107	SEI42C-486-FLAT_202		0.5312500	SEI42C-486-202
SEI42C-486-FLAT_108-NEW	15	0.0410000	SEI42C-486-108	SEI42C-486-FLAT_203	63	0.5364580	SEI42C-486-203
SEI42C-486-FLAT_109		0.0468750	SEI42C-486-109	SEI42C-486-FLAT_204		0.5416670	SEI42C-486-204
SEI42C-486-FLAT_110	16	0.0520830	SEI42C-486-110	SEI42C-486-FLAT_205	64	0.5468750	SEI42C-486-205
SEI42C-486-FLAT_111		0.0572920	SEI42C-486-111	SEI42C-486-FLAT_206		0.5520830	SEI42C-486-206
SEI42C-486-FLAT_112	17	0.0625000	SEI42C-486-112	SEI42C-486-FLAT_207	65	0.5572920	SEI42C-486-207
SEI42C-486-FLAT_113		0.0677080	SEI42C-486-113	SEI42C-486-FLAT_208		0.5625000	SEI42C-486-208
SEI42C-486-FLAT_114	18	0.0729170	SEI42C-486-114	SEI42C-486-FLAT_209	66	0.5677080	SEI42C-486-209
SEI42C-486-FLAT_115		0.0781250	SEI42C-486-115	SEI42C-486-FLAT_210		0.5729170	SEI42C-486-210
SEI42C-486-FLAT_116	19	0.0833330	SEI42C-486-116	SEI42C-486-FLAT_211	67	0.5781250	SEI42C-486-211
SEI42C-486-FLAT_117		0.0885420	SEI42C-486-117	SEI42C-486-FLAT_212		0.5833340	SEI42C-486-212
SEI42C-486-FLAT_118	20	0.0937500	SEI42C-486-118	SEI42C-486-FLAT_213	68	0.5885420	SEI42C-486-213
SEI42C-486-FLAT_119		0.0989580	SEI42C-486-119	SEI42C-486-FLAT_214		0.5937500	SEI42C-486-214
SEI42C-486-FLAT_120	21	0.1041670	SEI42C-486-120	SEI42C-486-FLAT_215	69	0.5989590	SEI42C-486-215
SEI42C-486-FLAT_121		0.1093750	SEI42C-486-121	SEI42C-486-FLAT_216		0.6041670	SEI42C-486-216
SEI42C-486-FLAT_122	22	0.1145830	SEI42C-486-122	SEI42C-486-FLAT_217	70	0.6093750	SEI42C-486-217
SEI42C-486-FLAT_123		0.1197920	SEI42C-486-123	SEI42C-486-FLAT_218		0.6145840	SEI42C-486-218
SEI42C-486-FLAT_124	23	0.1250000	SEI42C-486-124	SEI42C-486-FLAT_219	71	0.6197920	SEI42C-486-219
SEI42C-486-FLAT_125		0.1302080	SEI42C-486-125	SEI42C-486-FLAT_220		0.6250000	SEI42C-486-220
SEI42C-486-FLAT_126	24	0.1354170	SEI42C-486-126	SEI42C-486-FLAT_221	72	0.6302090	SEI42C-486-221
SEI42C-486-FLAT_127		0.1406250	SEI42C-486-127	SEI42C-486-FLAT_222		0.6354170	SEI42C-486-222
SEI42C-486-FLAT_128	25	0.1458330	SEI42C-486-128	SEI42C-486-FLAT_223	73	0.6406250	SEI42C-486-223
SEI42C-486-FLAT_129		0.1510420	SEI42C-486-129	SEI42C-486-FLAT_224		0.6458340	SEI42C-486-224
SEI42C-486-FLAT_130	26	0.1562500	SEI42C-486-130	SEI42C-486-FLAT_225	74	0.6510420	SEI42C-486-225
SEI42C-486-FLAT_131		0.1614580	SEI42C-486-131	SEI42C-486-FLAT_226		0.6562500	SEI42C-486-226
SEI42C-486-FLAT_132	27	0.1666670	SEI42C-486-132	SEI42C-486-FLAT_227	75	0.6614580	SEI42C-486-227
SEI42C-486-FLAT_133		0.1718750	SEI42C-486-133	SEI42C-486-FLAT_228		0.6666670	SEI42C-486-228
SEI42C-486-FLAT_134	28	0.1770830	SEI42C-486-134	SEI42C-486-FLAT_229	76	0.6718750	SEI42C-486-229
SEI42C-486-FLAT_135		0.1822920	SEI42C-486-135	SEI42C-486-FLAT_230		0.6770830	SEI42C-486-230
SEI42C-486-FLAT_136	29	0.1875000	SEI42C-486-136	SEI42C-486-FLAT_231	77	0.6822920	SEI42C-486-231
SEI42C-486-FLAT_137		0.1927080	SEI42C-486-137	SEI42C-486-FLAT_232		0.6875000	SEI42C-486-232
SEI42C-486-FLAT_138	30	0.1979170	SEI42C-486-138	SEI42C-486-FLAT_233	78	0.6927080	SEI42C-486-233
SEI42C-486-FLAT_139		0.1991170	SEI42C-486-139	SEI42C-486-FLAT_234		0.6979170	SEI42C-486-234
SEI42C-486-FLAT_140	31	0.2031250	SEI42C-486-140	SEI42C-486-FLAT_235	79	0.7031250	SEI42C-486-235
SEI42C-486-FLAT_141		0.2083330	SEI42C-486-141	SEI42C-486-FLAT_236		0.7083330	SEI42C-486-236
SEI42C-486-FLAT_142	32	0.2135420	SEI42C-486-142	SEI42C-486-FLAT_237	80	0.7135420	SEI42C-486-237
SEI42C-486-FLAT_143-NEW		0.2187500	SEI42C-486-143	SEI42C-486-FLAT_238		0.7187500	SEI42C-486-238
SEI42C-486-FLAT_144-NEW	33	0.2239580	SEI42C-486-144	SEI42C-486-FLAT_239	81	0.7239580	SEI42C-486-239
SEI42C-486-FLAT_145-NEW		0.2291670	SEI42C-486-145	SEI42C-486-FLAT_240-NEW		0.7291670	SEI42C-486-240
SEI42C-486-FLAT_146-NEW	34	0.2343750	SEI42C-486-146	SEI42C-486-FLAT_241-NEW	82	0.7343750	SEI42C-486-241
SEI42C-486-FLAT_147		0.2395830	SEI42C-486-147	SEI42C-486-FLAT_242-NEW		0.7395830	SEI42C-486-242
SEI42C-486-FLAT_148	35	0.2447920	SEI42C-486-148	SEI42C-486-FLAT_243-NEW	83	0.7447920	SEI42C-486-243
SEI42C-486-FLAT_149		0.2500000	SEI42C-486-149	SEI42C-486-FLAT_244-NEW		0.7500000	SEI42C-486-244
SEI42C-486-FLAT_150	36	0.2552080	SEI42C-486-150	SEI42C-486-FLAT_245	84	0.7552080	SEI42C-486-245
SEI42C-486-FLAT_151		0.2604170	SEI42C-486-151	SEI42C-486-FLAT_246		0.7604170	SEI42C-486-246
SEI42C-486-FLAT_152	37	0.2656250	SEI42C-486-152	SEI42C-486-FLAT_247	85	0.7656250	SEI42C-486-247
SEI42C-486-FLAT_153		0.2708330	SEI42C-486-153	SEI42C-486-FLAT_248		0.7708330	SEI42C-486-248
SEI42C-486-FLAT_154	38	0.2760420	SEI42C-486-154	SEI42C-486-FLAT_249	86	0.7760420	SEI42C-486-249
SEI42C-486-FLAT_155		0.2812500	SEI42C-486-155	SEI42C-486-FLAT_250		0.7812500	SEI42C-486-250
SEI42C-486-FLAT_156	39	0.2864580	SEI42C-486-156	SEI42C-486-FLAT_251	87	0.7864580	SEI42C-486-251
SEI42C-486-FLAT_157		0.2916670	SEI42C-486-157	SEI42C-486-FLAT_252		0.7916670	SEI42C-486-252
SEI42C-486-FLAT_158	40	0.2968750	SEI42C-486-158	SEI42C-486-FLAT_253	88	0.7968750	SEI42C-486-253
SEI42C-486-FLAT_159		0.3020830	SEI42C-486-159	SEI42C-486-FLAT_254		0.8020830	SEI42C-486-254
SEI42C-486-FLAT_160	41	0.3072920	SEI42C-486-160	SEI42C-486-FLAT_255	89	0.8072920	SEI42C-486-255
SEI42C-486-FLAT_161		0.3125000	SEI42C-486-161	SEI42C-486-FLAT_256		0.8125000	SEI42C-486-256
SEI42C-486-FLAT_162	42	0.3177080	SEI42C-486-162	SEI42C-486-FLAT_257	90	0.8177080	SEI42C-486-257
SEI42C-486-FLAT_163		0.3229170	SEI42C-486-163	SEI42C-486-FLAT_258		0.8229170	SEI42C-486-258
SEI42C-486-FLAT_164	43	0.3281250	SEI42C-486-164	SEI42C-486-FLAT_259	91	0.8281250	SEI42C-486-259
SEI42C-486-FLAT_165		0.3333330	SEI42C-486-165	SEI42C-486-FLAT_260		0.8333330	SEI42C-486-260
SEI42C-486-FLAT_166	44	0.3385420	SEI42C-486-166	SEI42C-486-FLAT_261	92	0.8385420	SEI42C-486-261
SEI42C-486-FLAT_167		0.3437500	SEI42C-486-167	SEI42C-486-FLAT_262		0.8437500	SEI42C-486-262
SEI42C-486-FLAT_168	45	0.3489580	SEI42C-486-168	SEI42C-486-FLAT_263	93	0.8489580	SEI42C-486-263
SEI42C-486-FLAT_169		0.3541670	SEI42C-486-169	SEI42C-486-FLAT_264		0.8541670	SEI42C-486-264
SEI42C-486-FLAT_170	46	0.3593750	SEI42C-486-170	SEI42C-486-FLAT_265	94	0.8593750	SEI42C-486-265
SEI42C-486-FLAT_171		0.3645830	SEI42C-486-171	SEI42C-486-FLAT_266		0.8645830	SEI42C-486-266
SEI42C-486-FLAT_172	47	0.3697920	SEI42C-486-172	SEI42C-486-FLAT_267	95	0.8697920	SEI42C-486-267
SEI42C-486-FLAT_173		0.3750000	SEI42C-486-173	SEI42C-486-FLAT_268		0.8750000	SEI42C-486-268
	48	0.3802080	SEI42C-486-173	SEI42C-486-FLAT_269	96	0.8802080	SEI42C-486-269

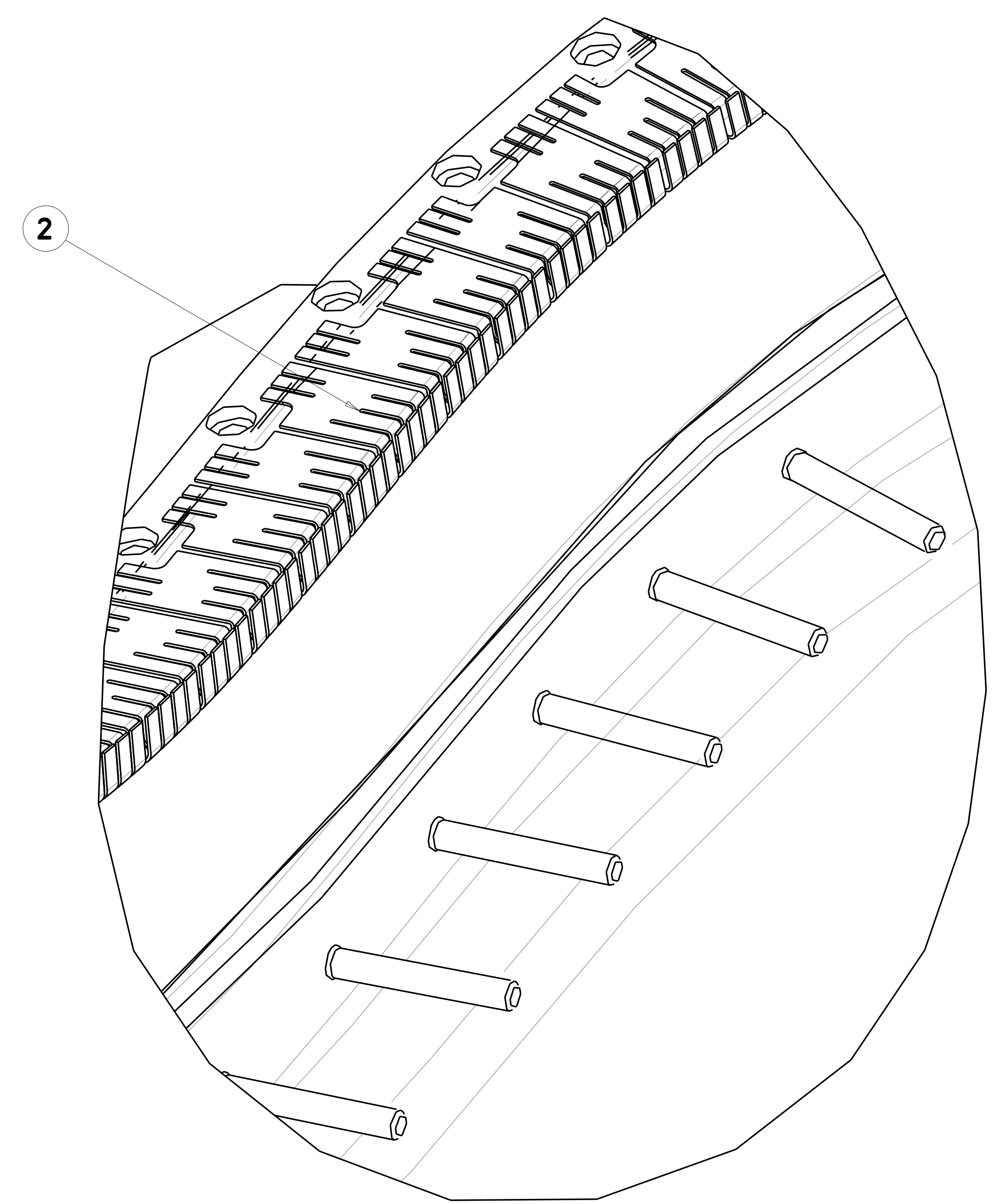

1 ISOMETRIC VIEW
 SCALE 1.00

RELEASED FOR

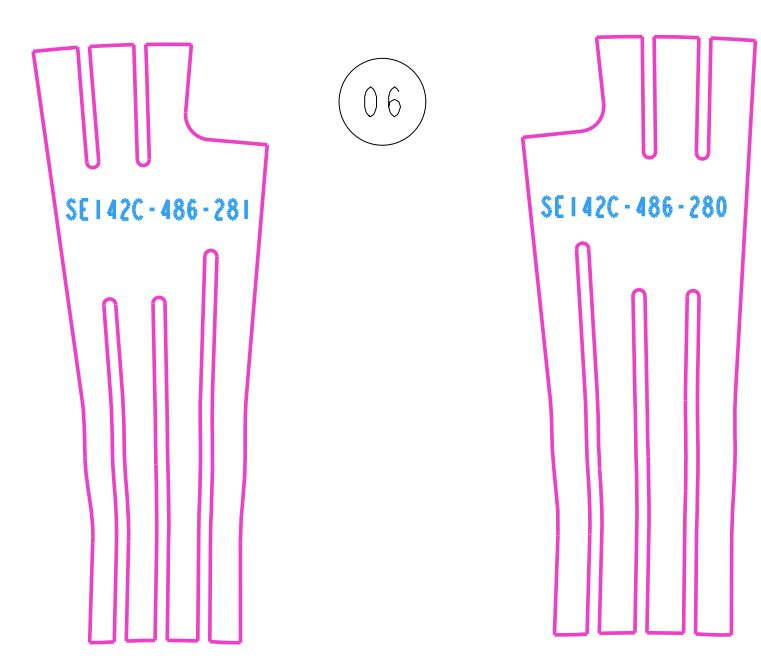

INSTANCE: SEI42C-486_FLAT_281

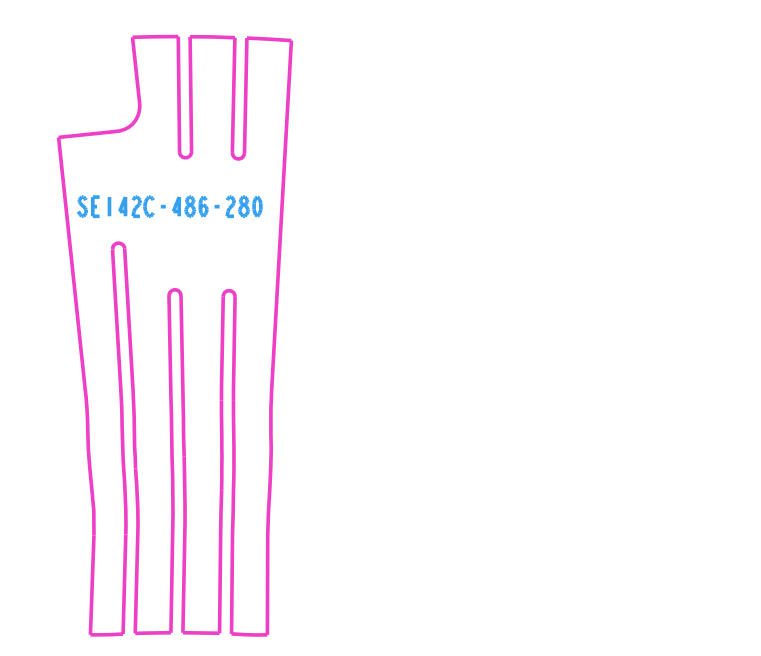

INSTANCE: SEI42C-486_FLAT_280

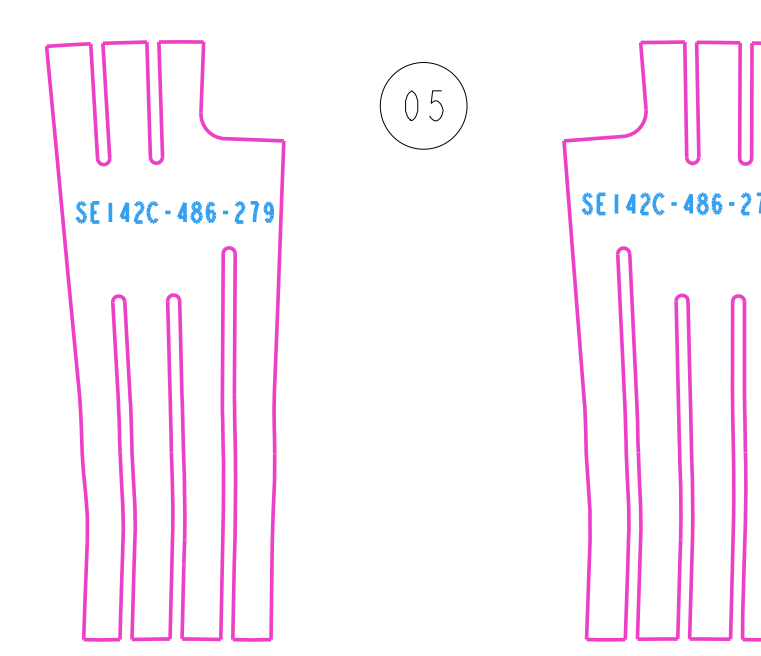

INSTANCE: SEI42C-486_FLAT_279

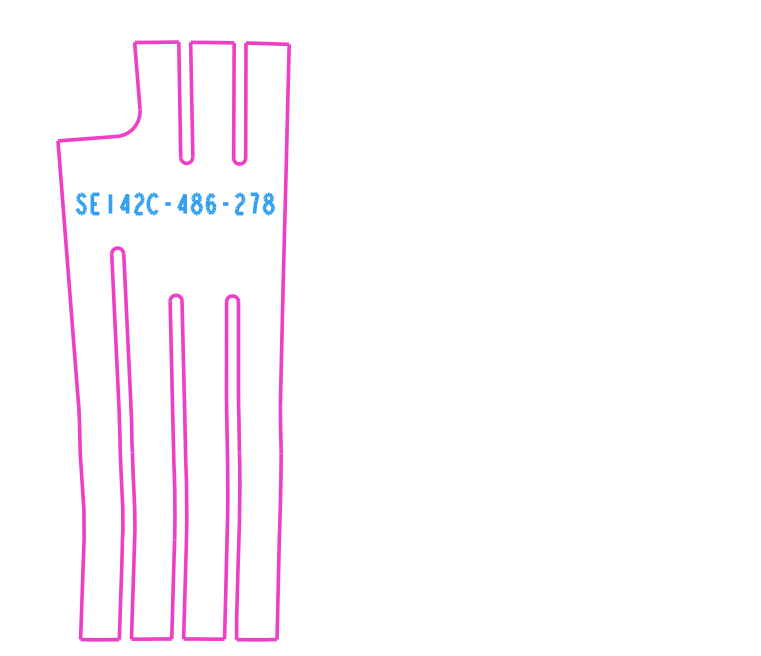

INSTANCE: SEI42C-486_FLAT_278

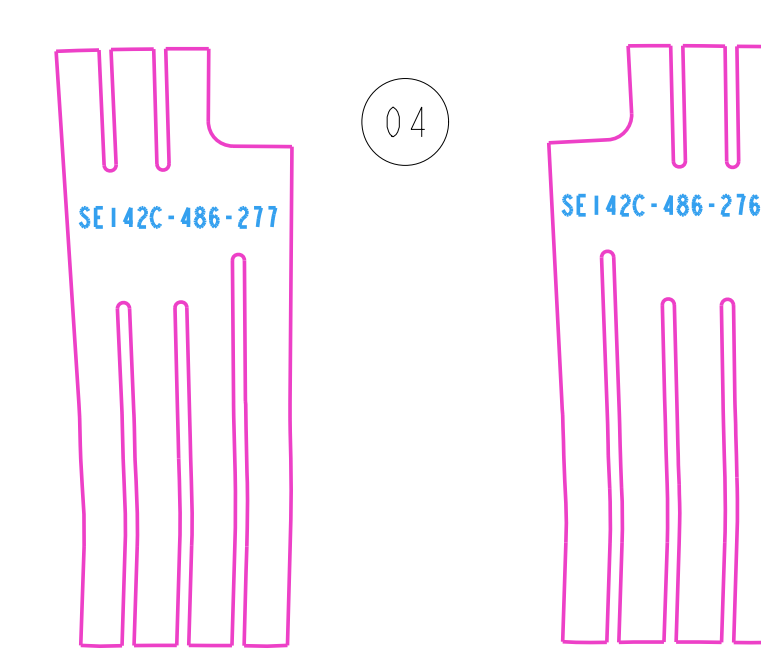

INSTANCE: SEI42C-486_FLAT_277

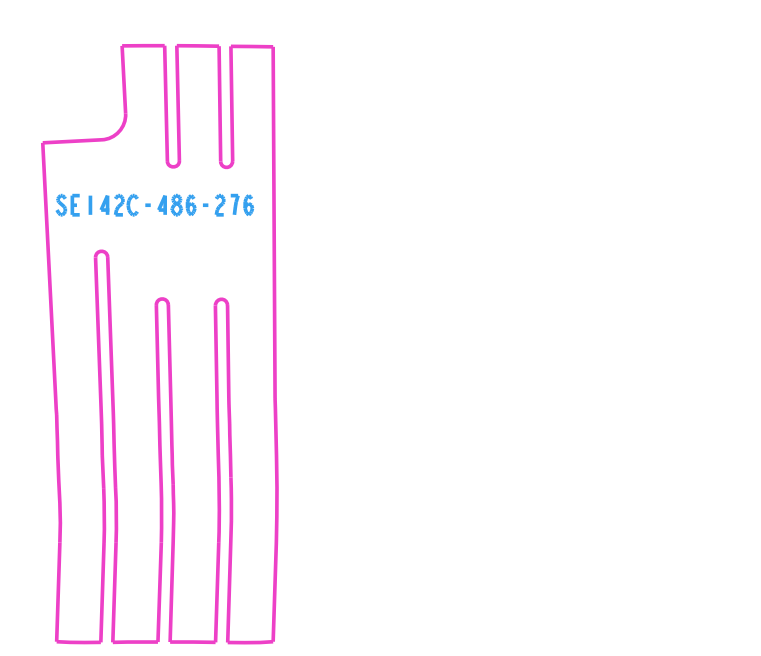

INSTANCE: SEI42C-486_FLAT_276

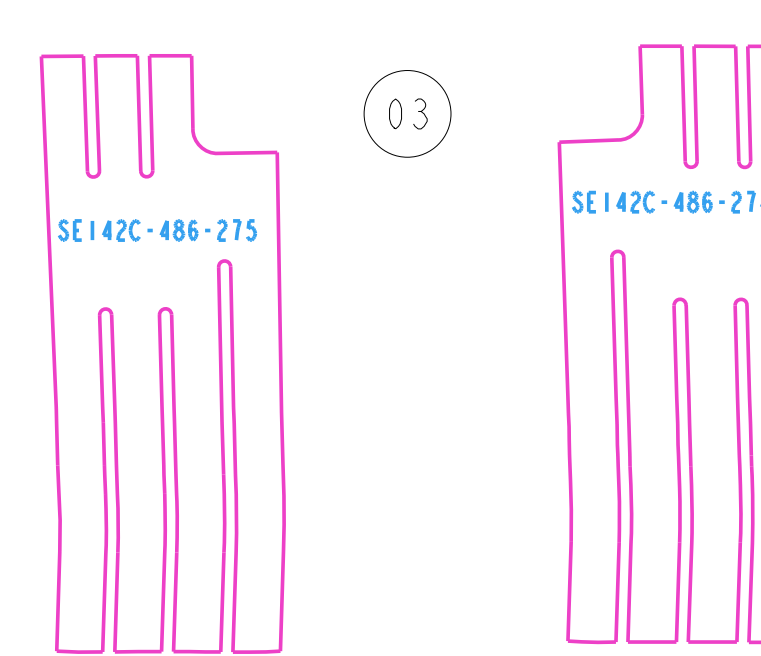

INSTANCE: SEI42C-486_FLAT_275

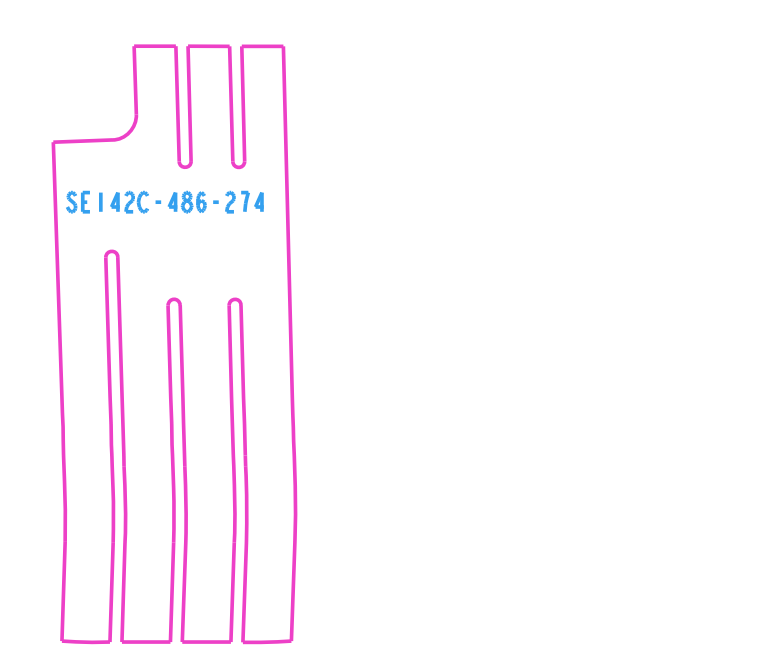

INSTANCE: SEI42C-486_FLAT_274

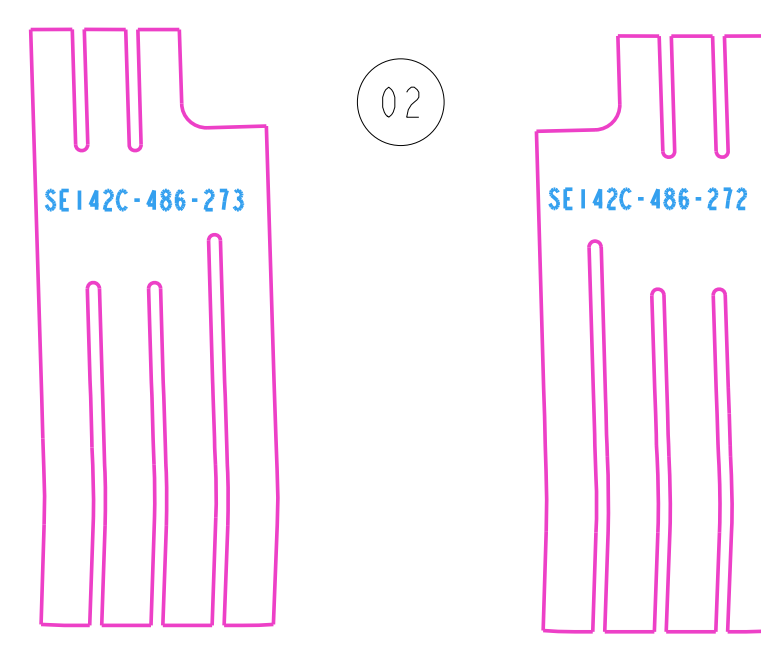

INSTANCE: SEI42C-486_FLAT_273

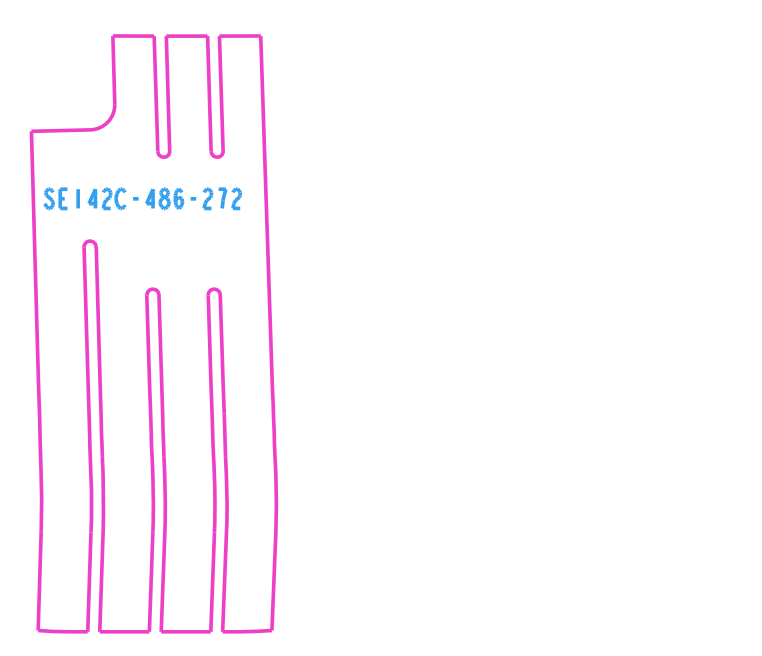

INSTANCE: SEI42C-486_FLAT_272

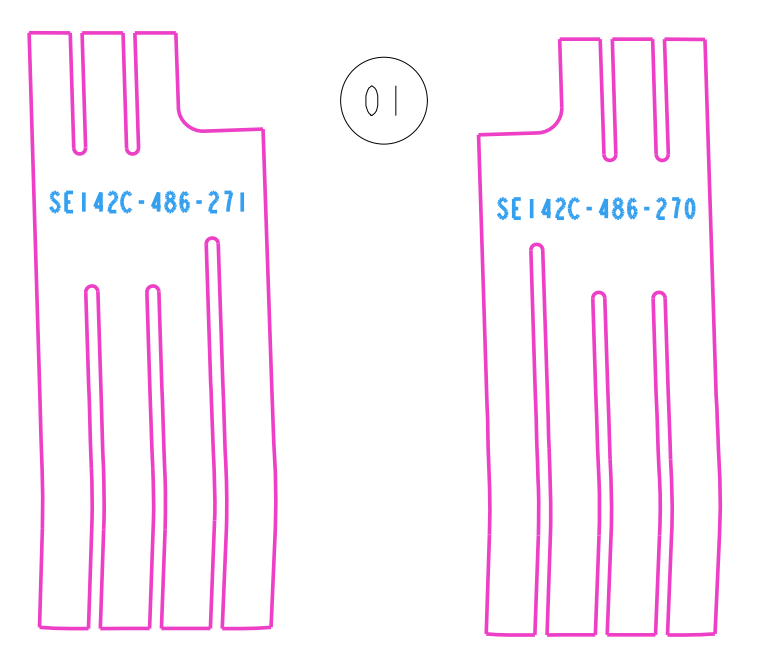

INSTANCE: SEI42C-486_FLAT_271

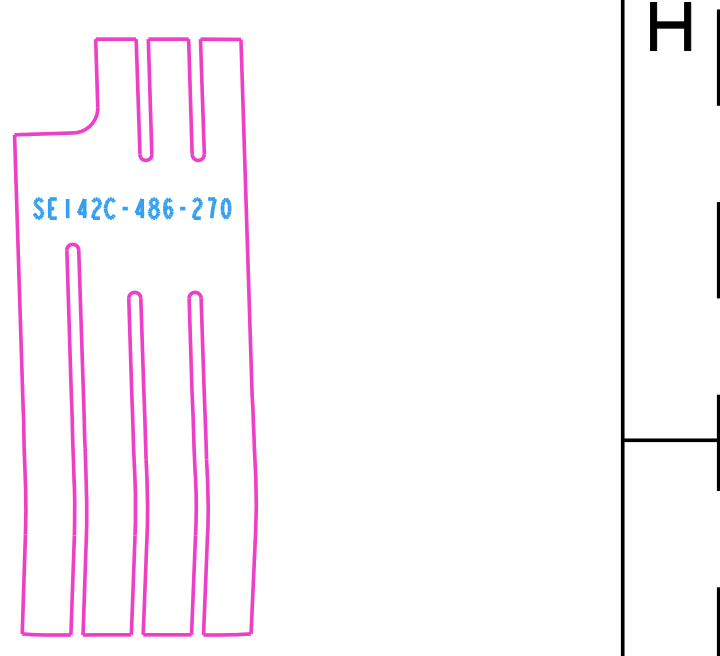

INSTANCE: SEI42C-486_FLAT_270

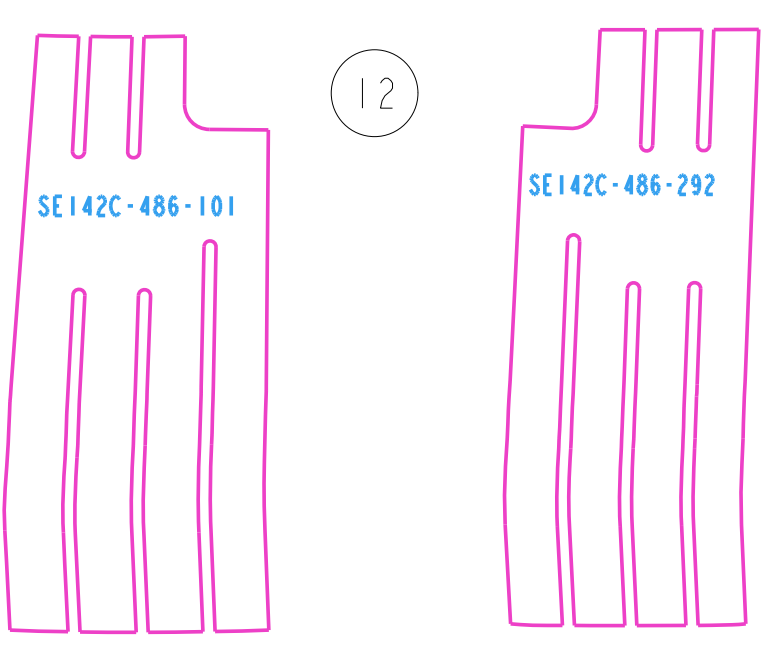

INSTANCE: SEI42C-486_FLAT_101

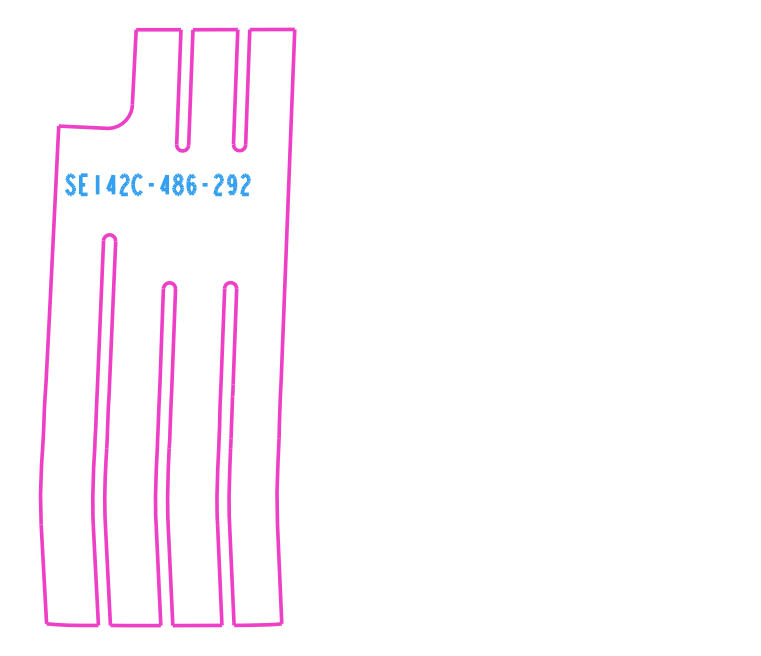

INSTANCE: SEI42C-486_FLAT_292-NEW

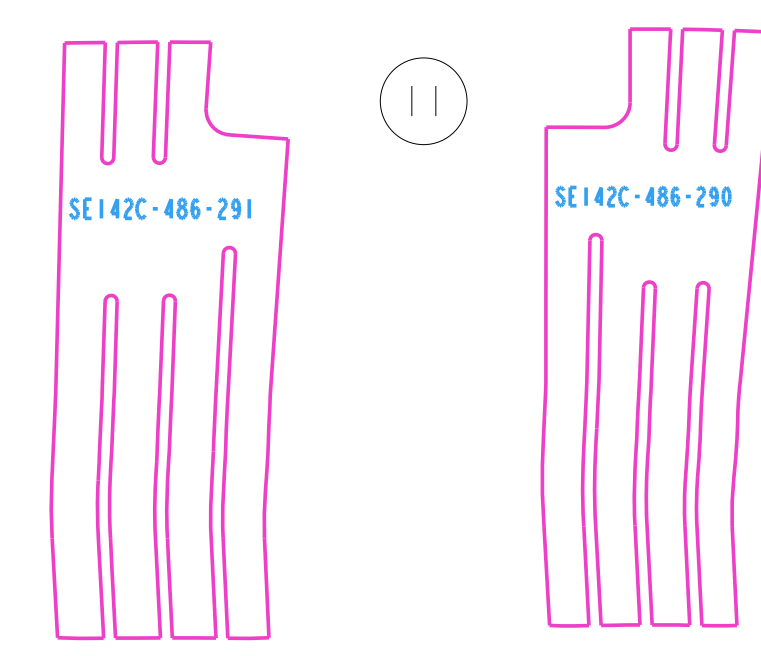

INSTANCE: SEI42C-486_FLAT_291

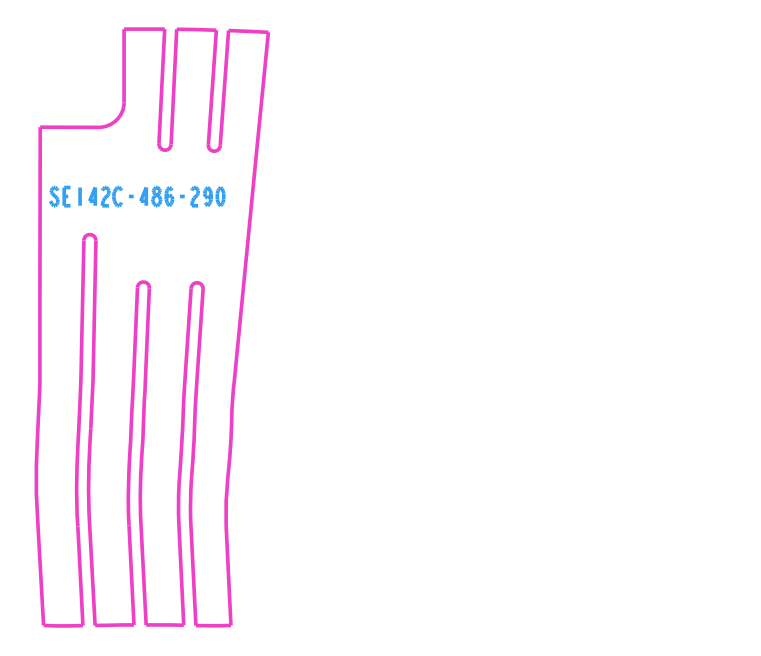

INSTANCE: SEI42C-486_FLAT_290

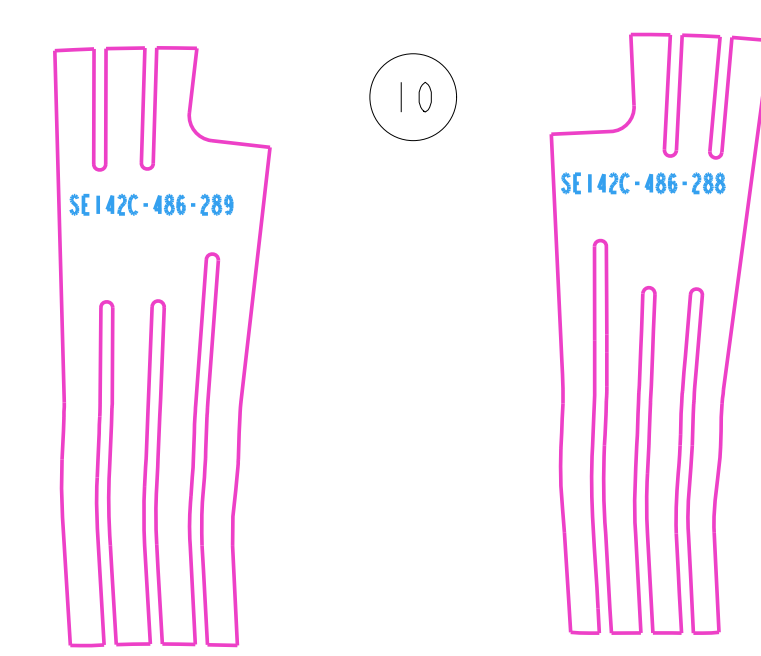

INSTANCE: SEI42C-486_FLAT_289

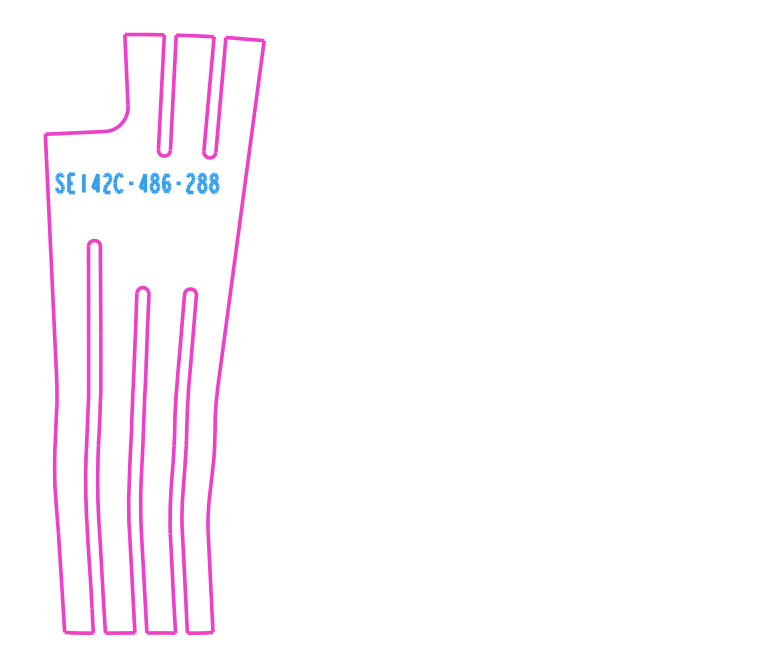

INSTANCE: SEI42C-486_FLAT_288

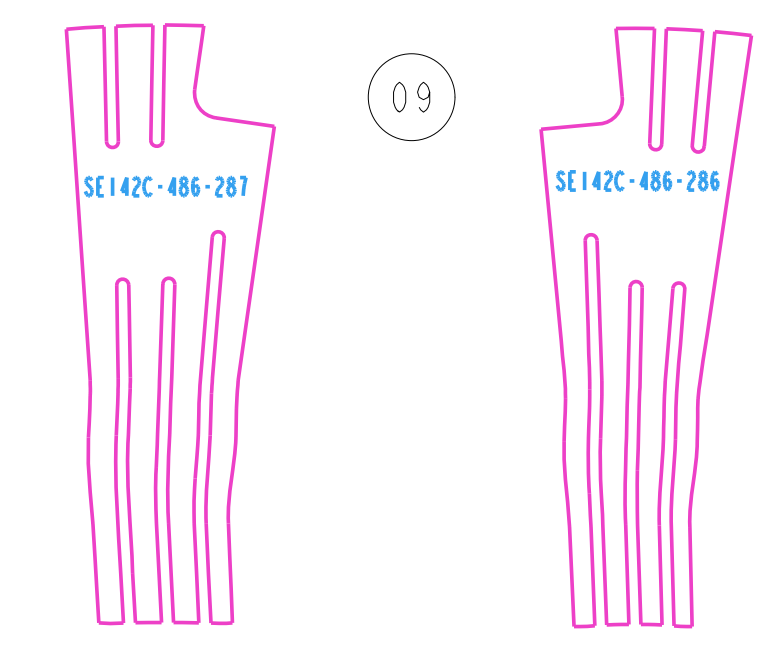

INSTANCE: SEI42C-486_FLAT_287

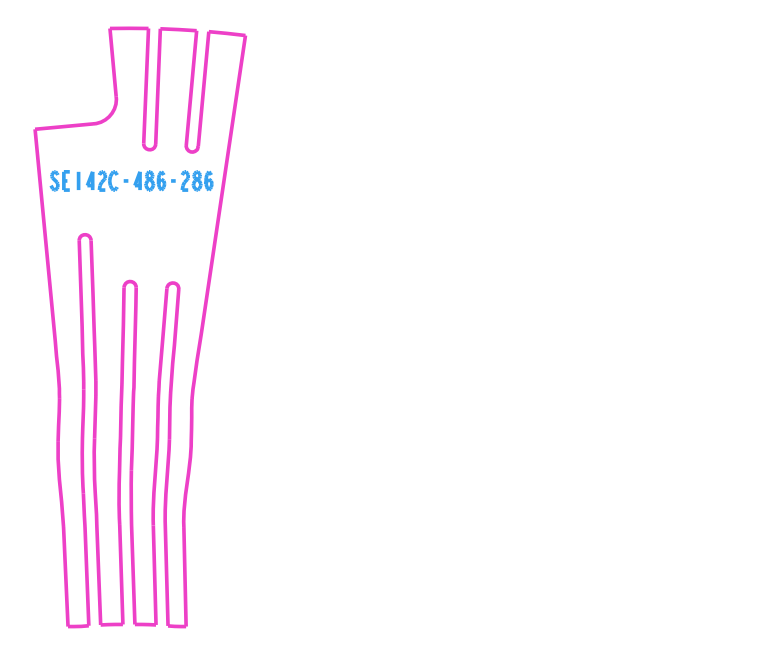

INSTANCE: SEI42C-486_FLAT_286

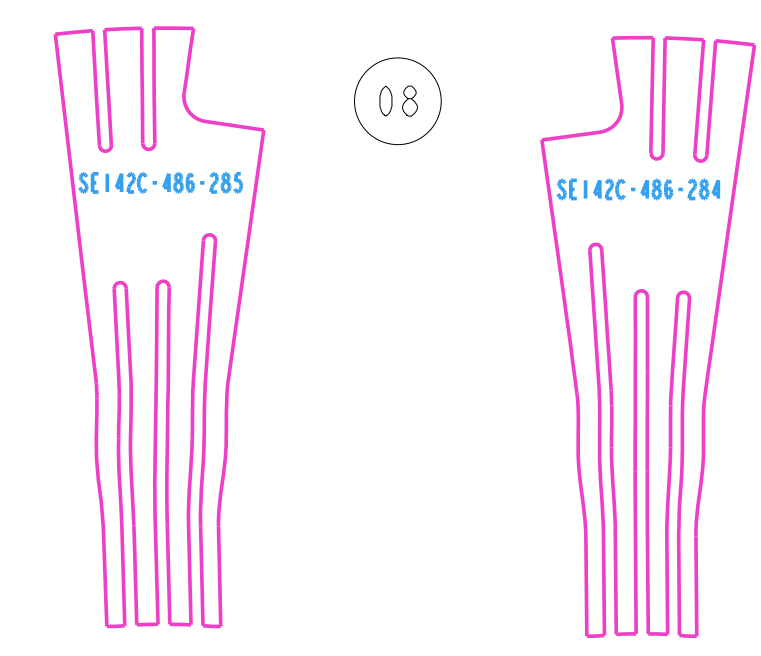

INSTANCE: SEI42C-486_FLAT_285

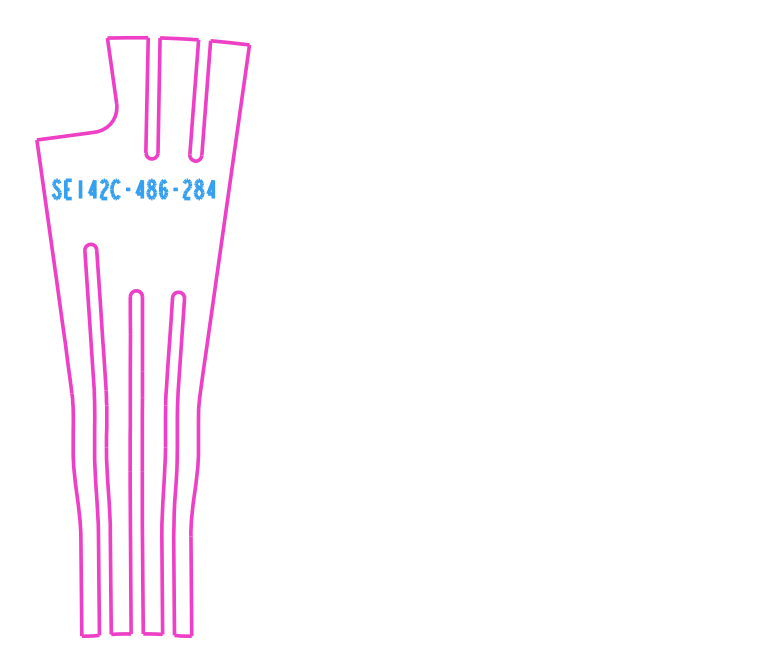

INSTANCE: SEI42C-486_FLAT_284

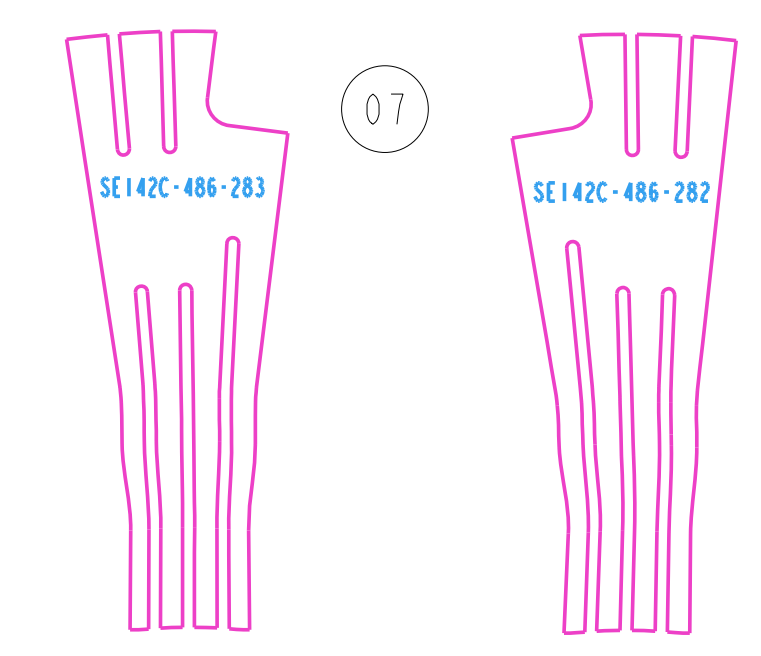

INSTANCE: SEI42C-486_FLAT_283

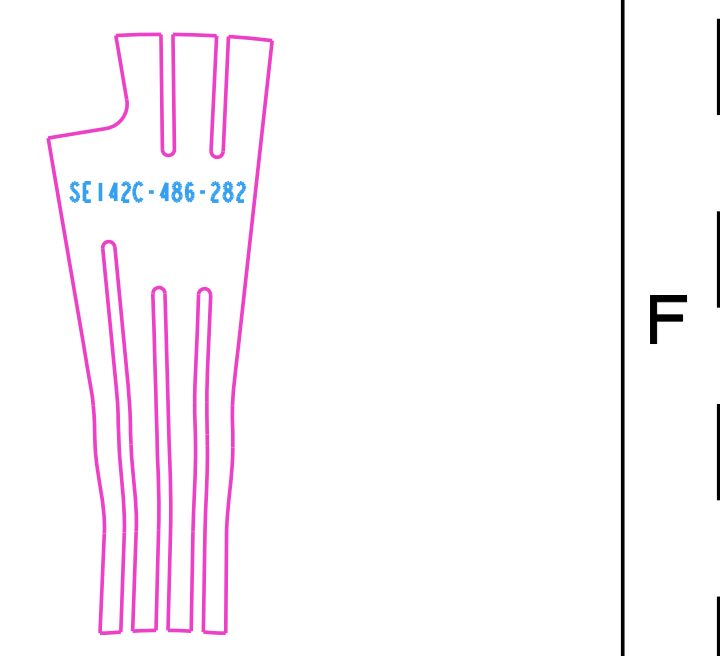

INSTANCE: SEI42C-486_FLAT_282

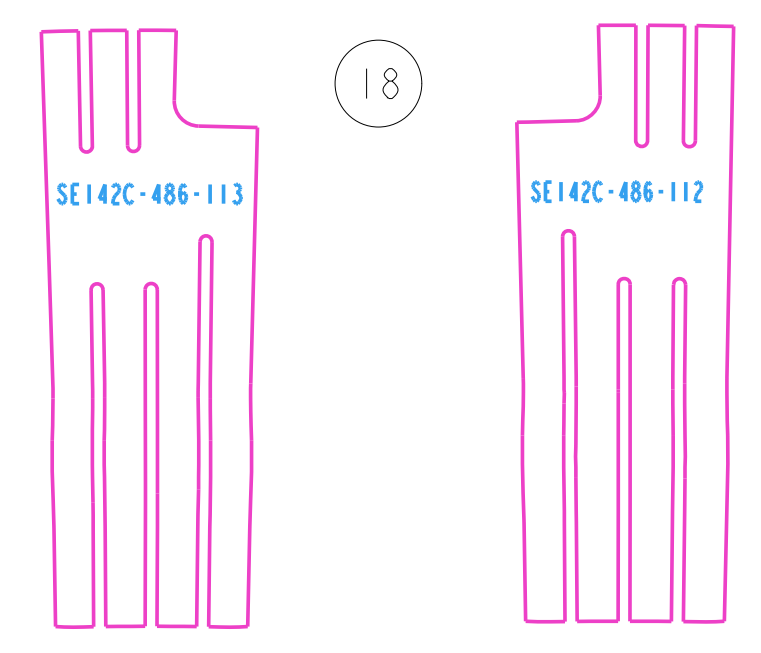

INSTANCE: SEI42C-486_FLAT_113

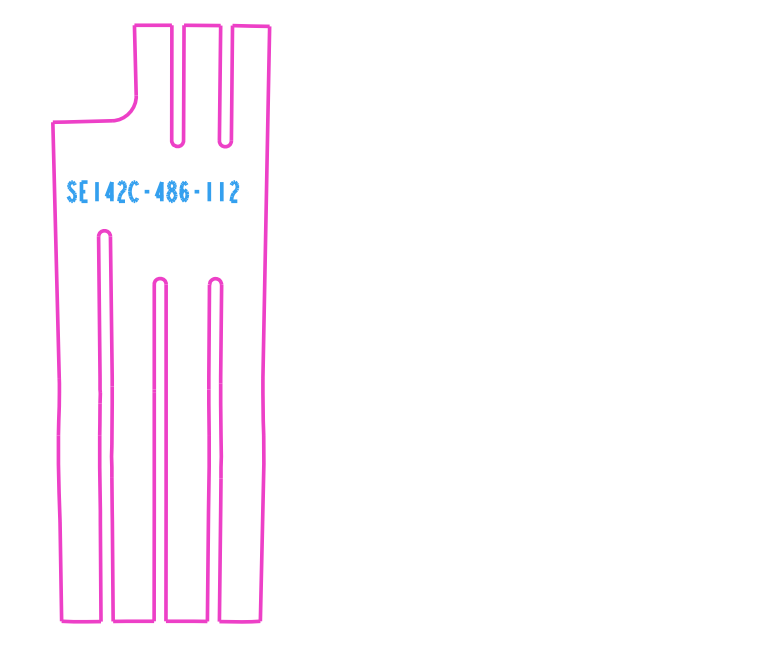

INSTANCE: SEI42C-486_FLAT_112

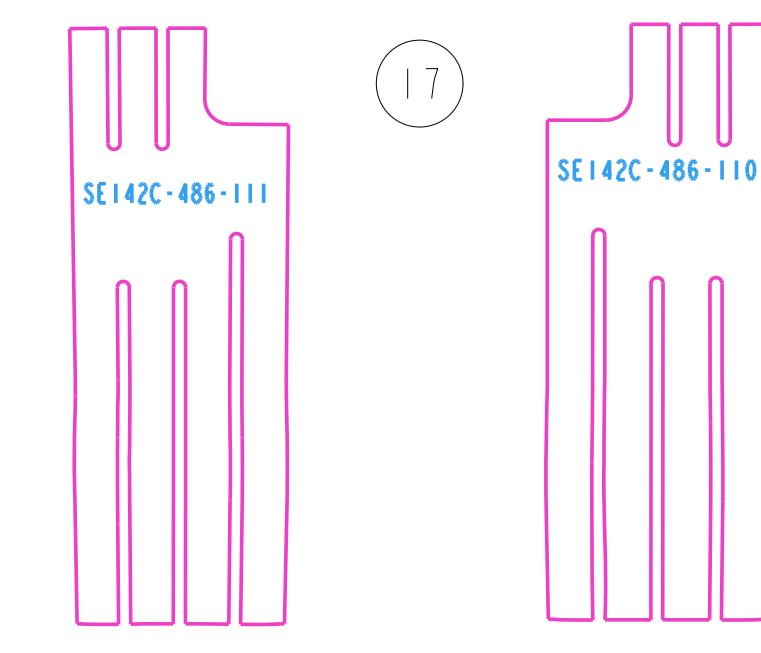

INSTANCE: SEI42C-486_FLAT_111

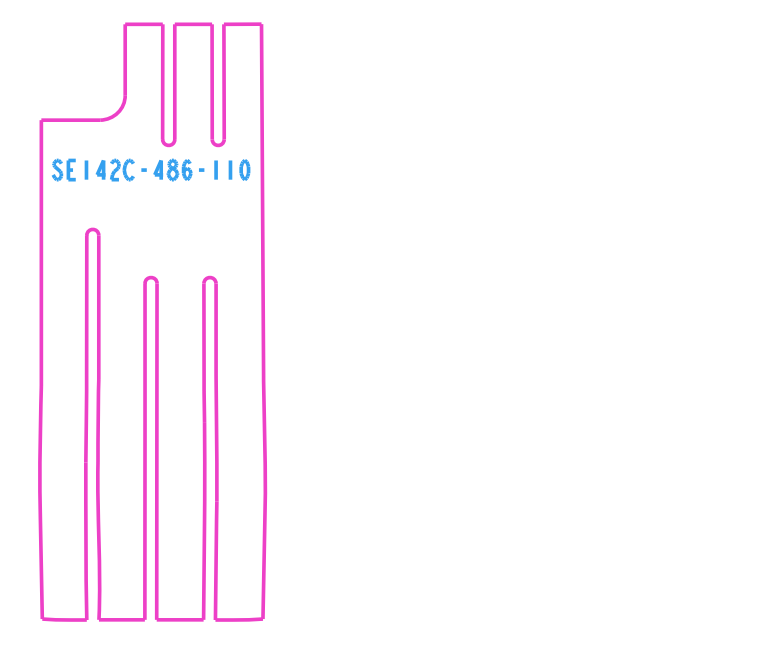

INSTANCE: SEI42C-486_FLAT_110

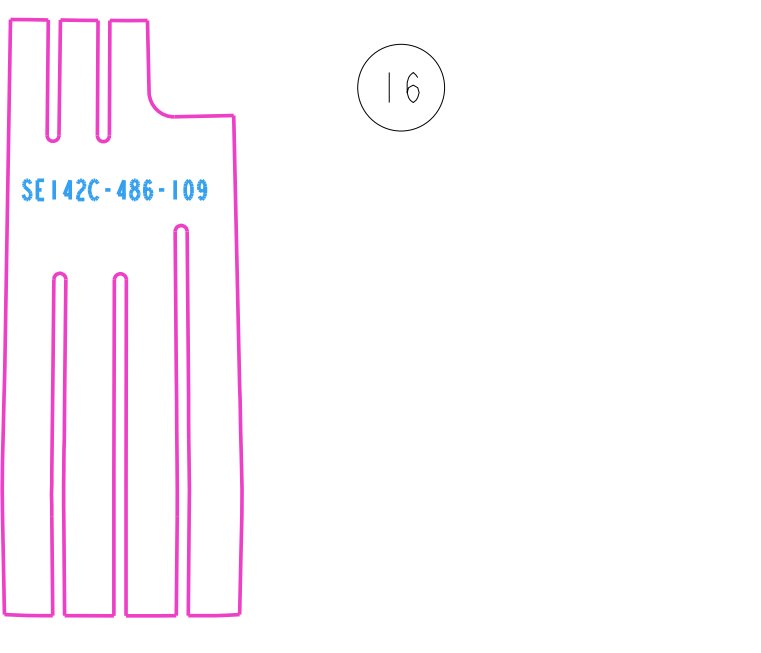

INSTANCE: SEI42C-486_FLAT_109

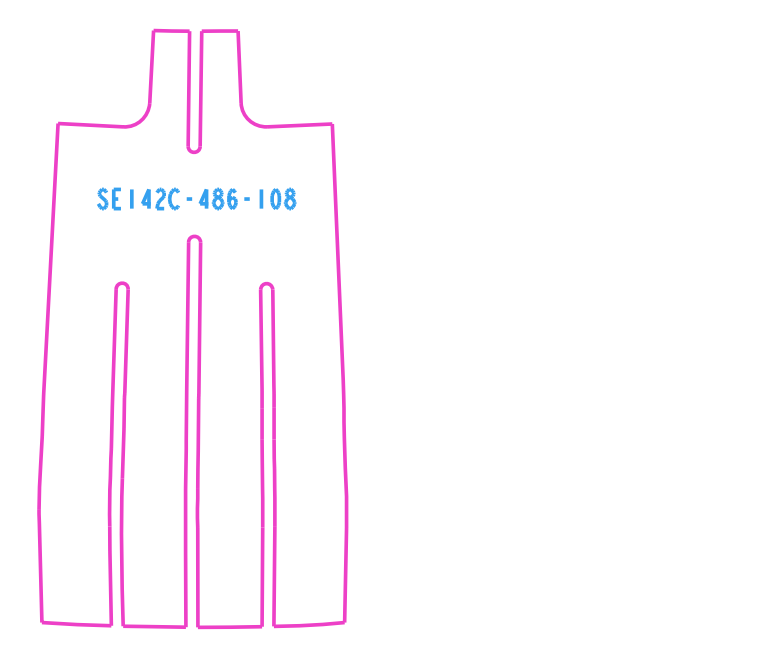

INSTANCE: SEI42C-486_FLAT_108-NEW

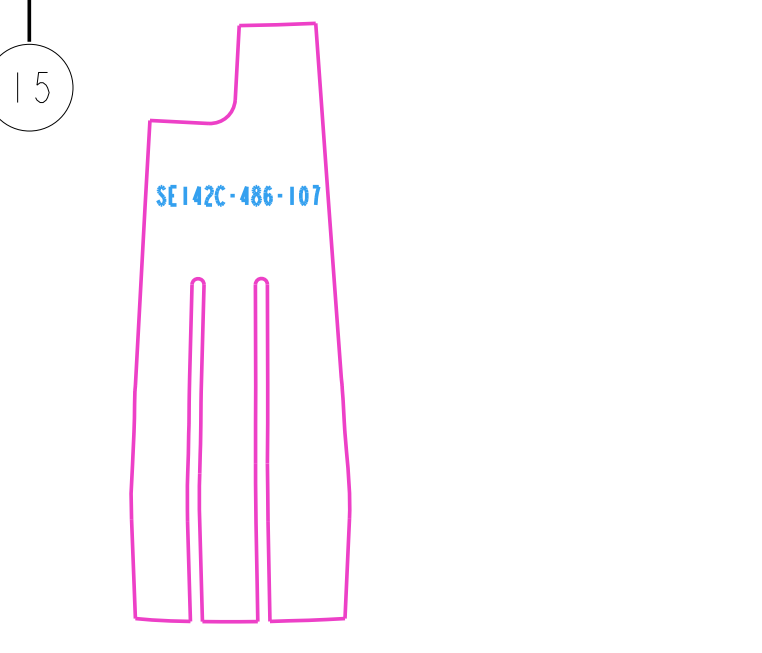

INSTANCE: SEI42C-486_FLAT_107-NEW

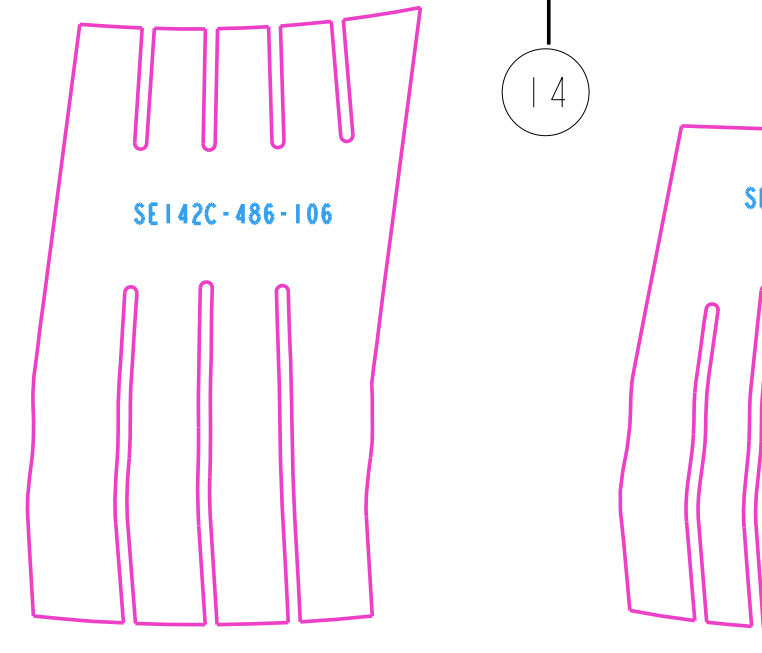

INSTANCE: SEI42C-486_FLAT_106-NEW

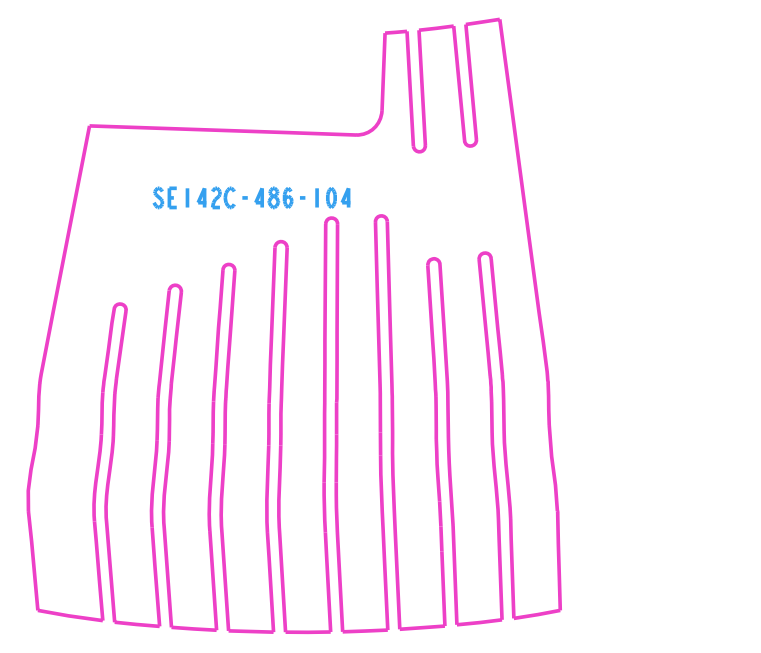

INSTANCE: SEI42C-486_FLAT_104-NEW

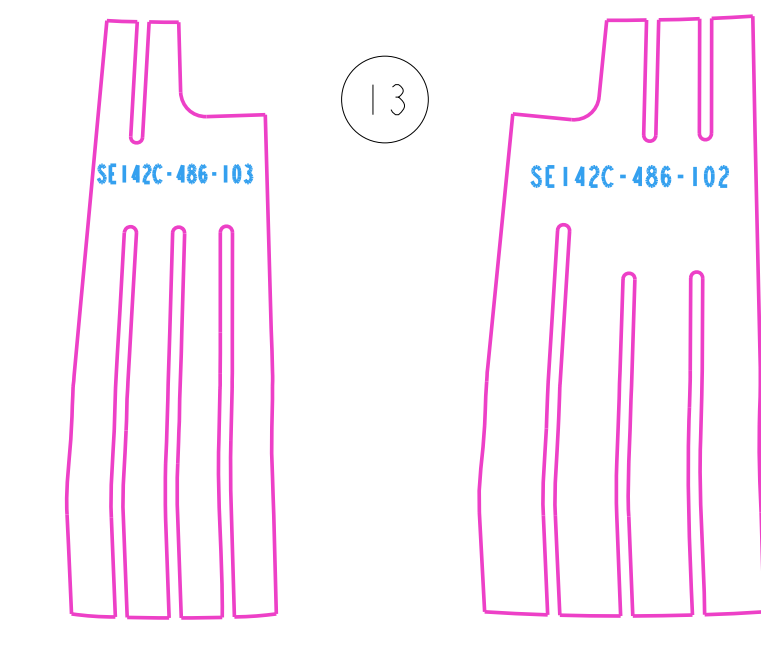

INSTANCE: SEI42C-486_FLAT_103-NEW

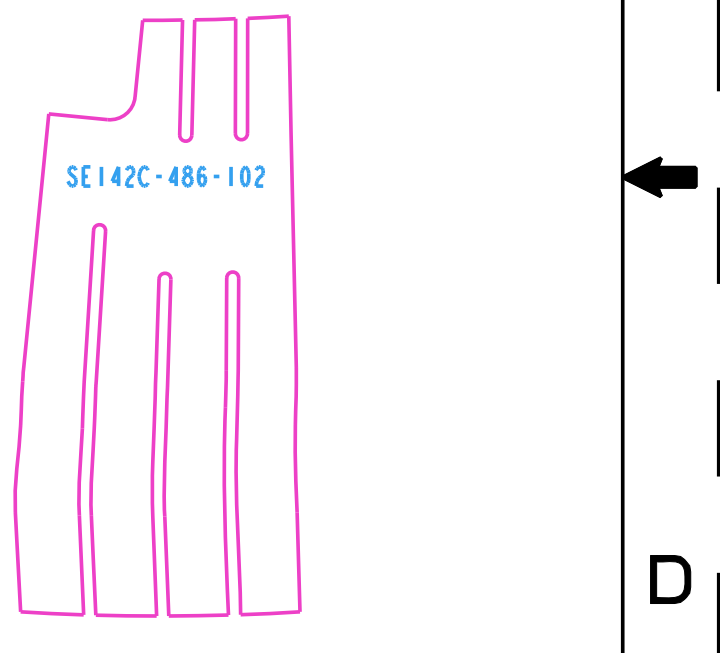

INSTANCE: SEI42C-486_FLAT_102

POLODIAL BREAK

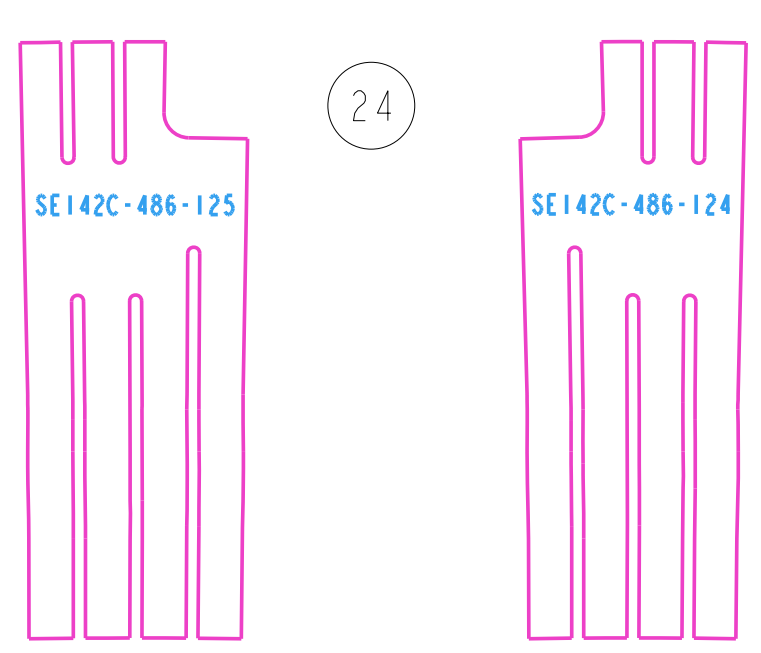

INSTANCE: SEI42C-486_FLAT_125

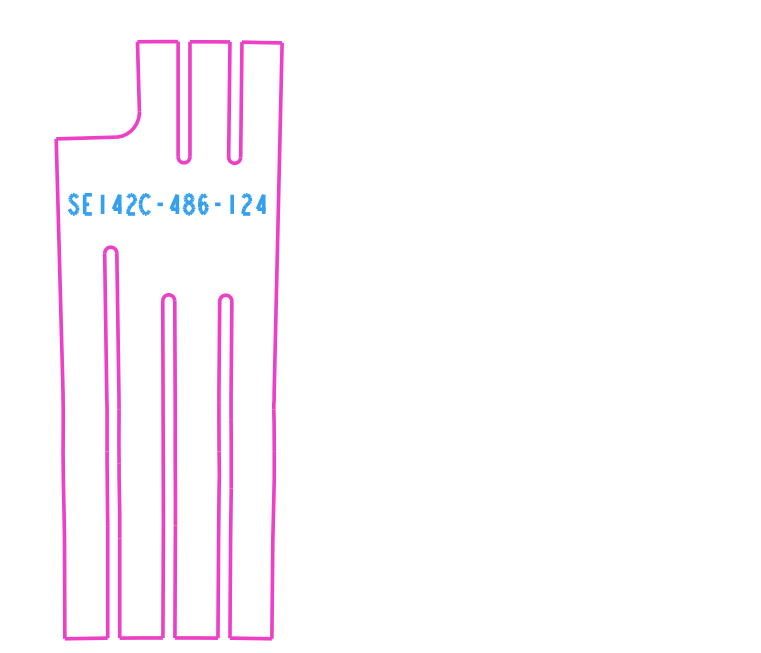

INSTANCE: SEI42C-486_FLAT_124

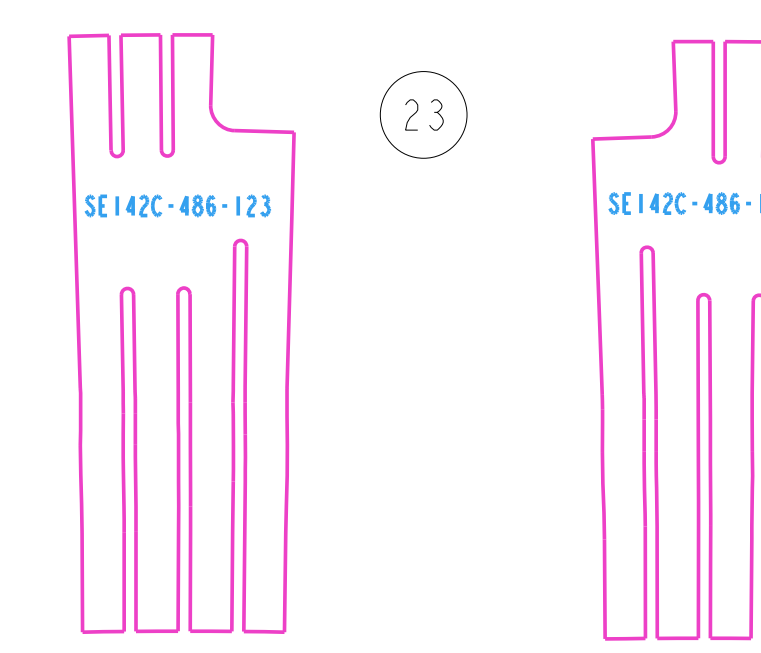

INSTANCE: SEI42C-486_FLAT_123

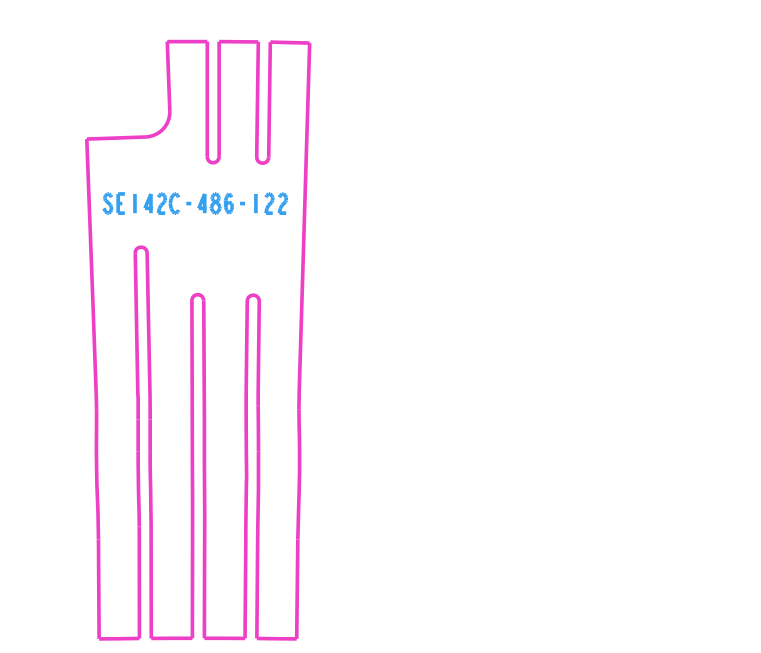

INSTANCE: SEI42C-486_FLAT_122

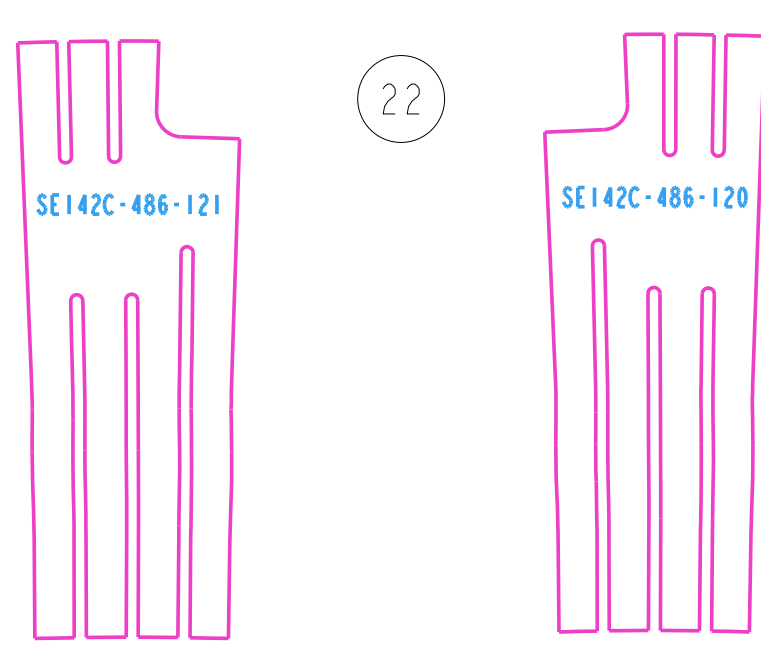

INSTANCE: SEI42C-486_FLAT_121

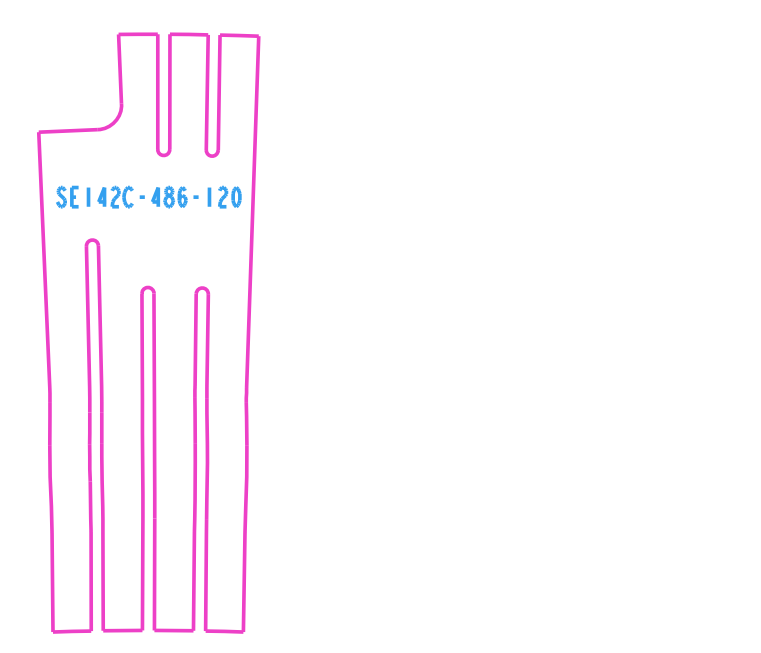

INSTANCE: SEI42C-486_FLAT_120

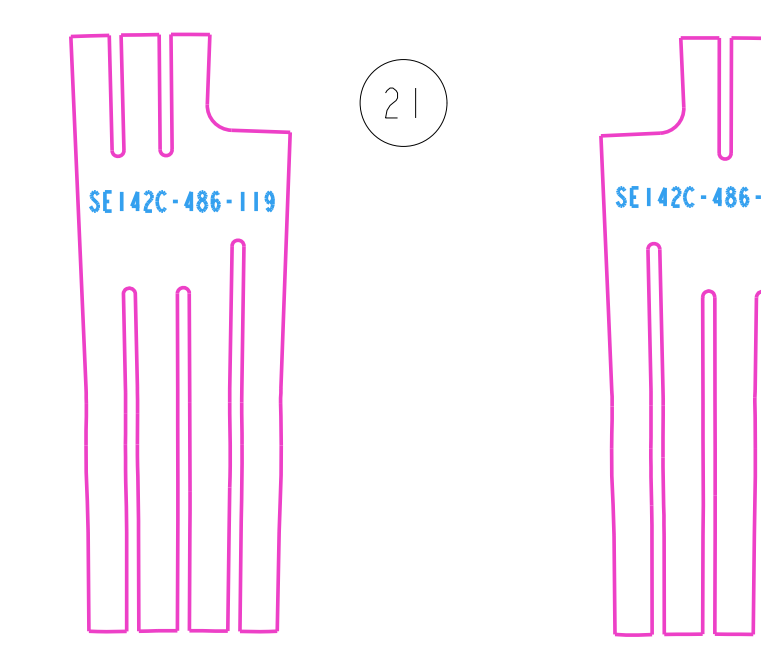

INSTANCE: SEI42C-486_FLAT_119

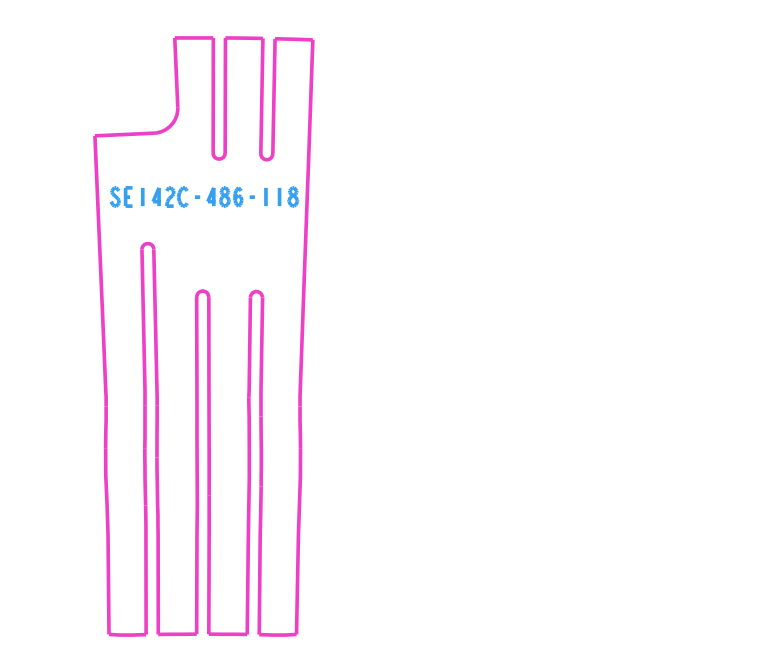

INSTANCE: SEI42C-486_FLAT_118

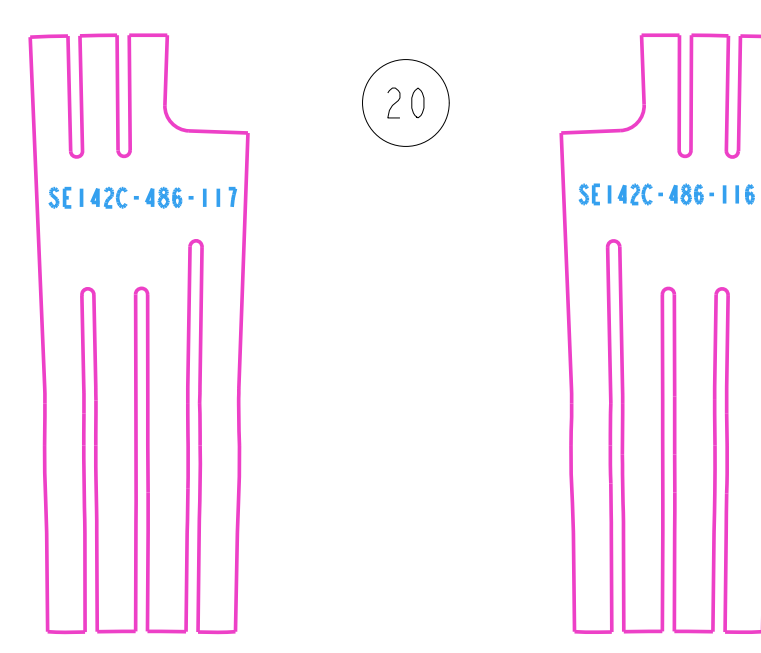

INSTANCE: SEI42C-486_FLAT_117

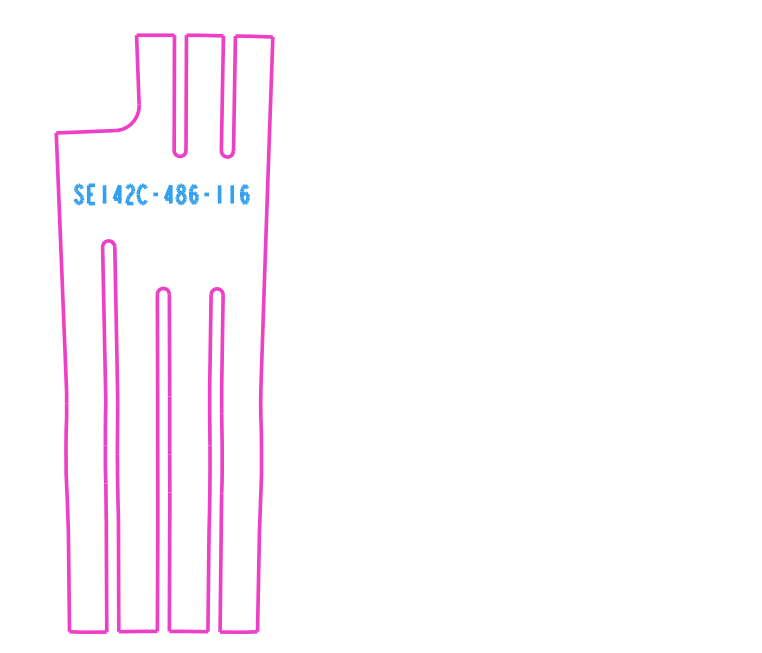

INSTANCE: SEI42C-486_FLAT_116

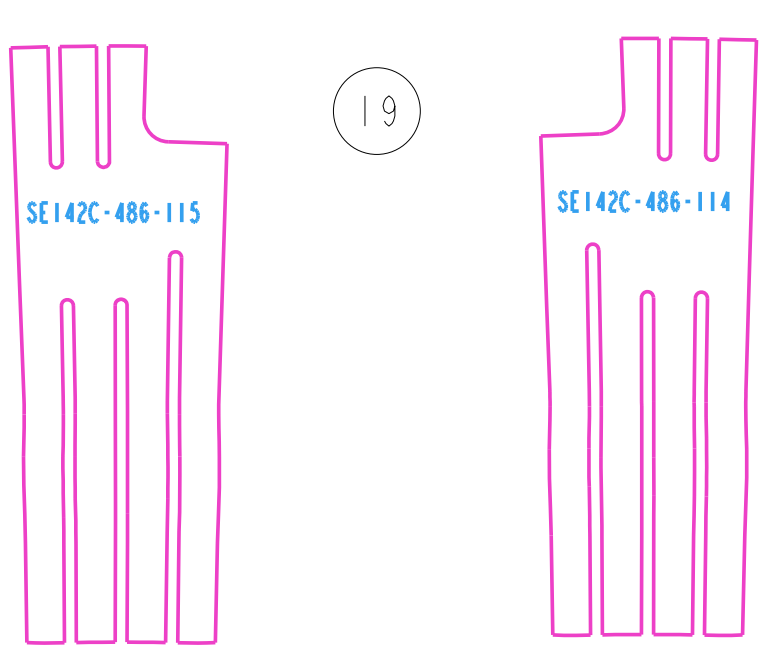

INSTANCE: SEI42C-486_FLAT_115

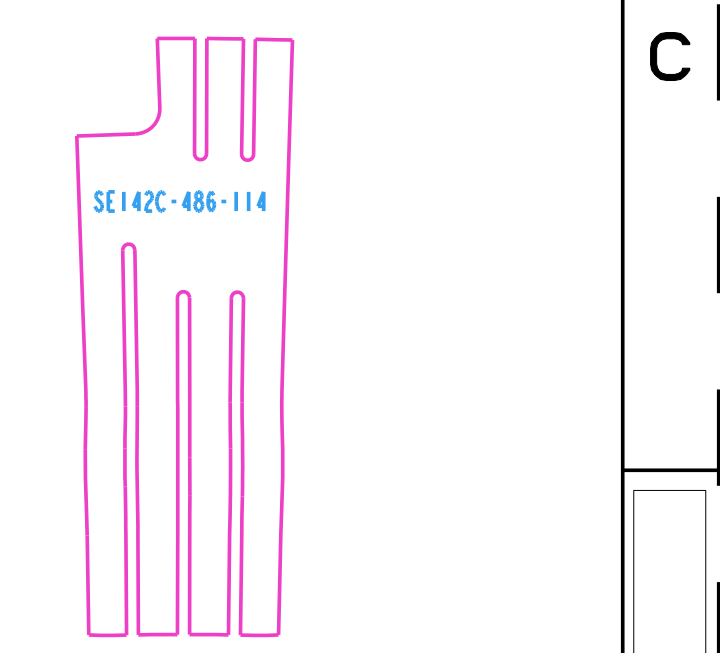

INSTANCE: SEI42C-486_FLAT_114

SCALE ALL VIEWS: 1.00

RELEASED FOR FABRICATION / INSTALLATION
PPPL Drafting:

UT-BATTELLE		Oak Ridge National Laboratory managed for the DEPARTMENT OF ENERGY under U.S. GOVERNMENT contract DE-AC05-00OR22725 UT-BATTELLE, LLC, Oak Ridge, Tennessee	
PROJECT NAME NATIONAL COMPACT STELLARATOR EXPERIMENT			
MODULAR COIL TYPE - C SIDE -B UPPER (TOP) CHILL PLATES FLAT PATTERN LAYOUT			
VERSION NO.	PLANT	BLDG	FL
8	X-10	5700	3
SHT OF	TYPE	CLASS	
2	S	U	
RELEASE LEVEL		REV	
Fabrication		SEI42C-486	
		0	

SEI42C-486

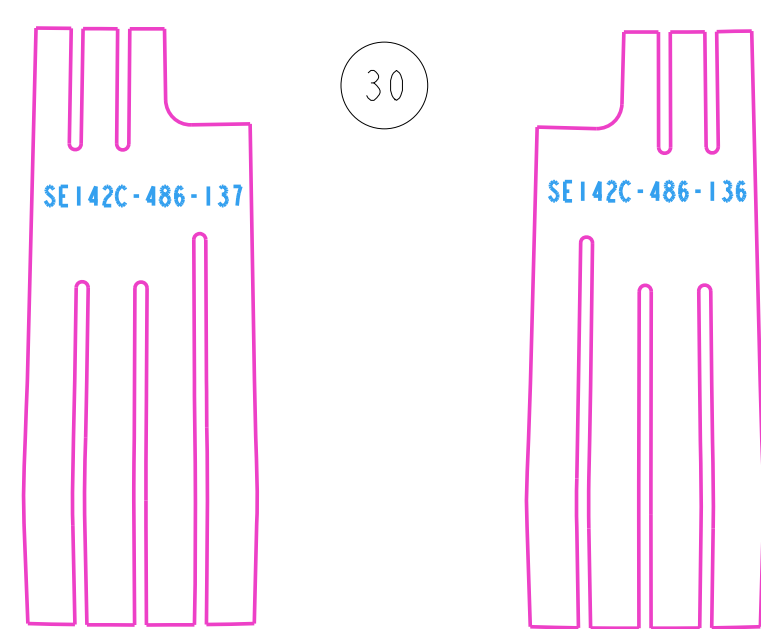

INSTANCE:
SE142C-486_FLAT_137

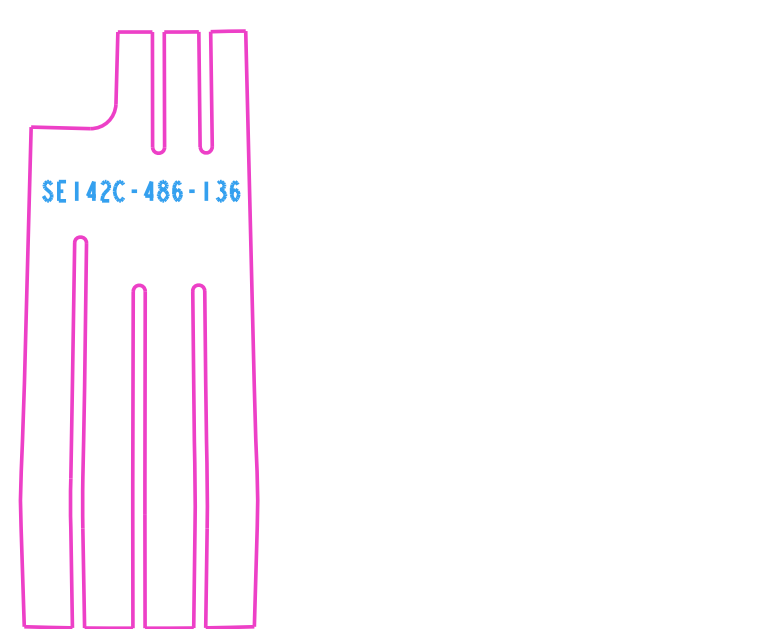

INSTANCE:
SE142C-486_FLAT_136

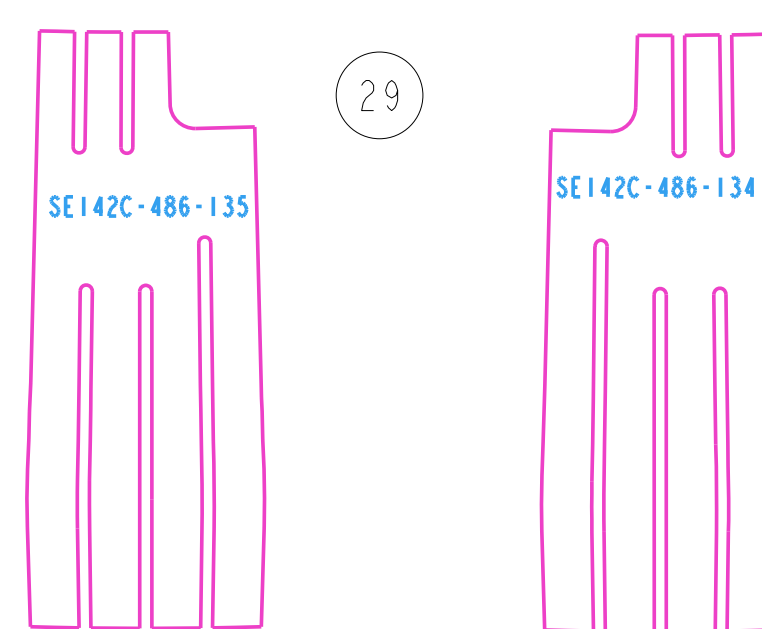

INSTANCE:
SE142C-486_FLAT_135

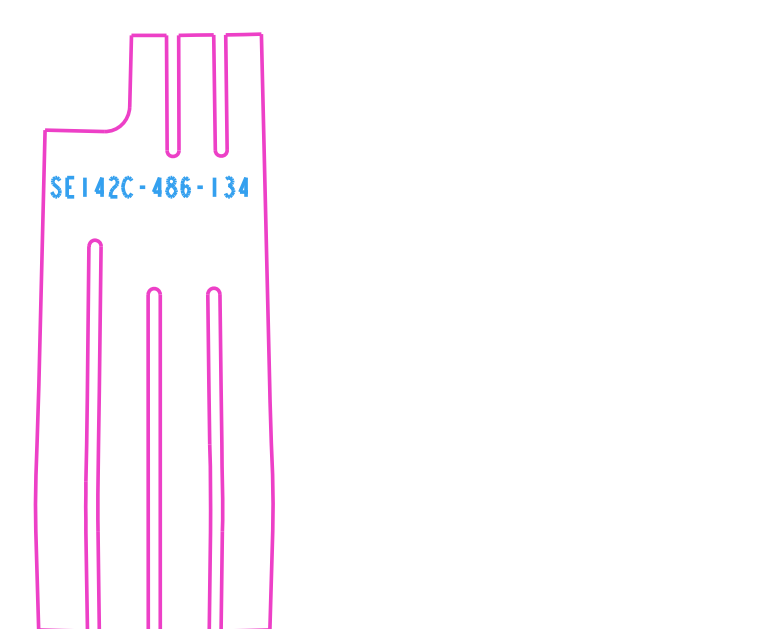

INSTANCE:
SE142C-486_FLAT_134

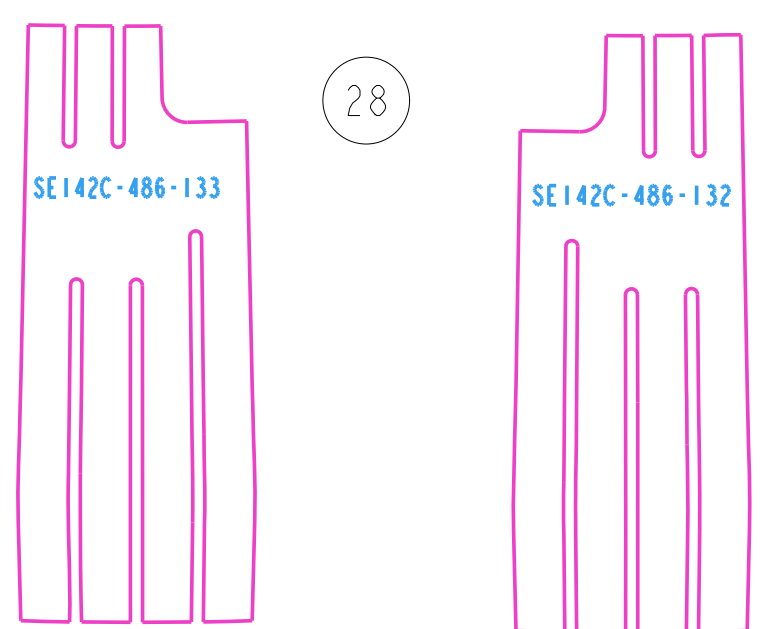

INSTANCE:
SE142C-486_FLAT_133

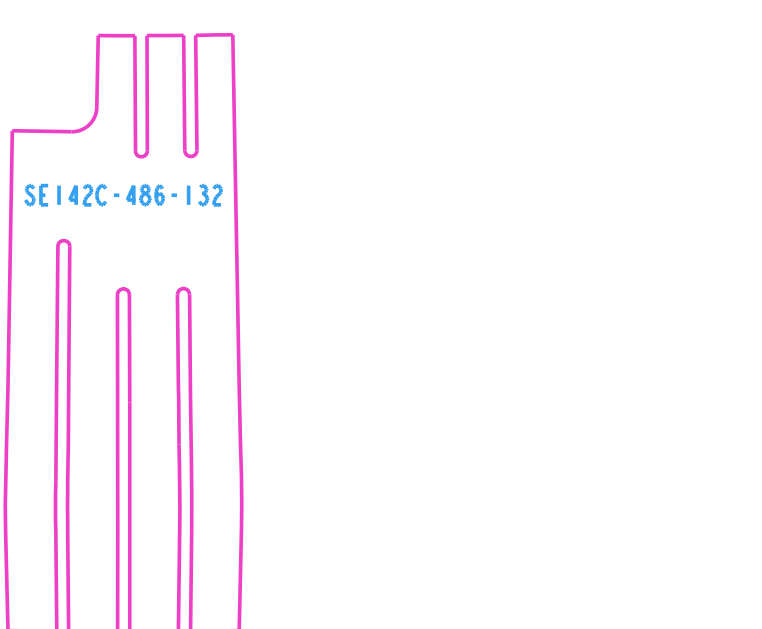

INSTANCE:
SE142C-486_FLAT_132

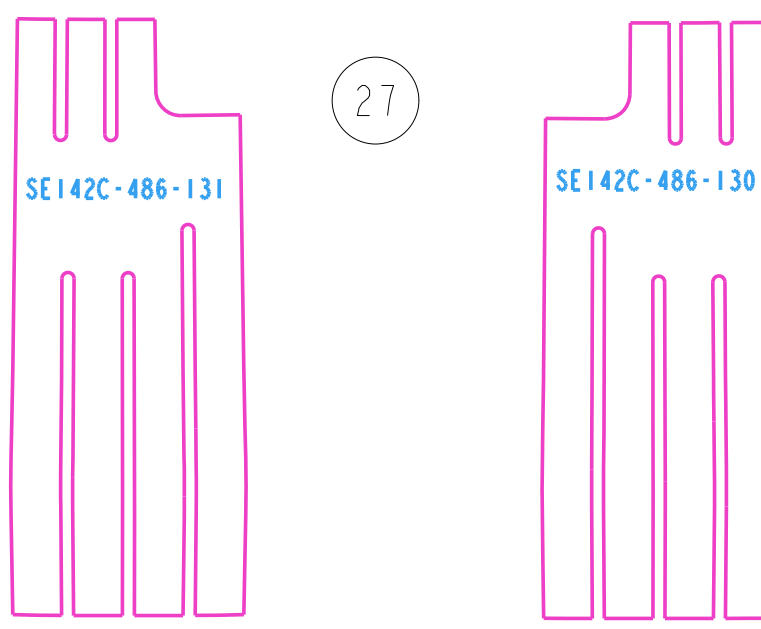

INSTANCE:
SE142C-486_FLAT_131

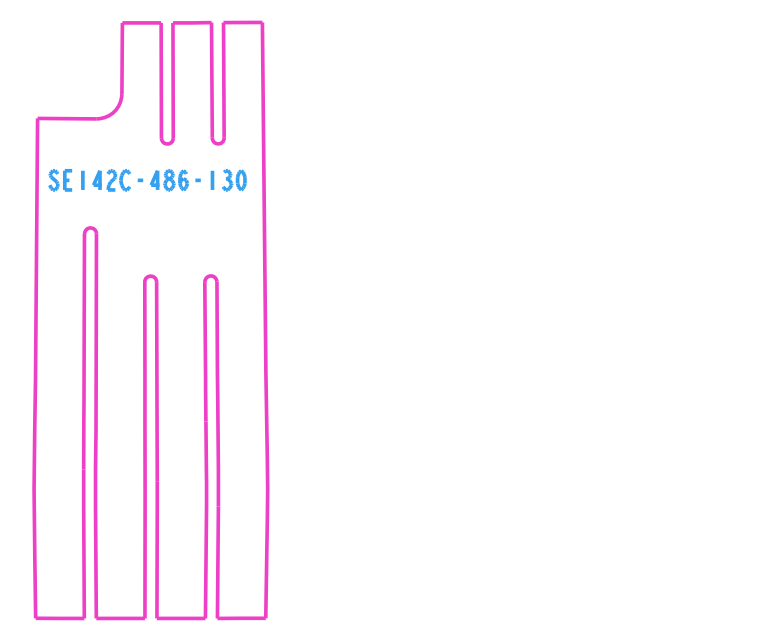

INSTANCE:
SE142C-486_FLAT_130

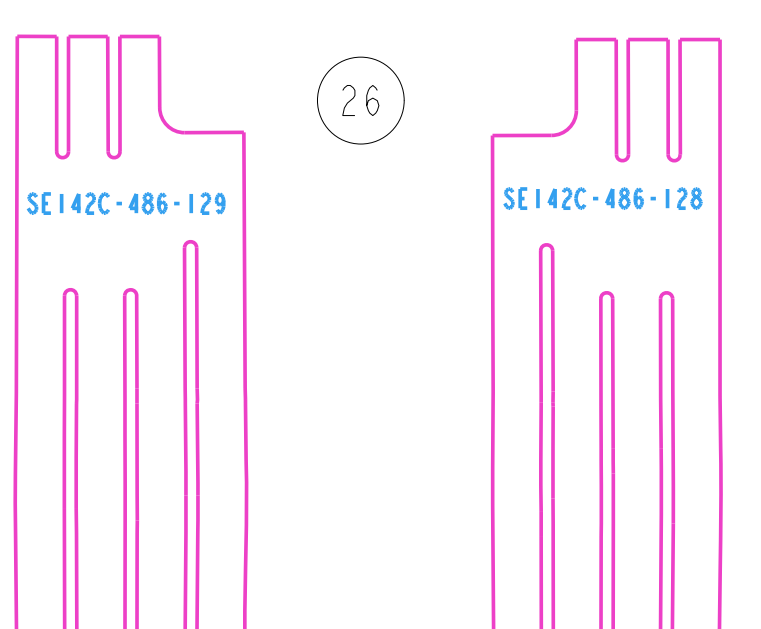

INSTANCE:
SE142C-486_FLAT_129

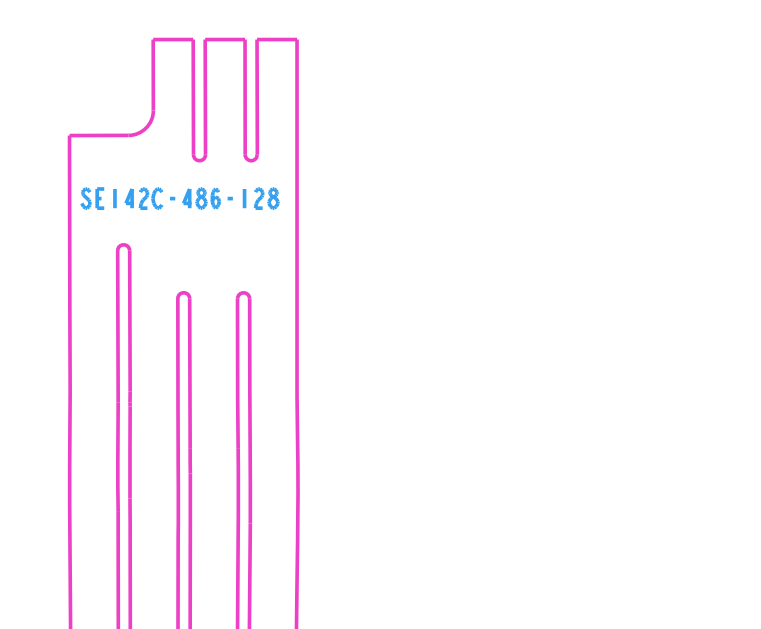

INSTANCE:
SE142C-486_FLAT_128

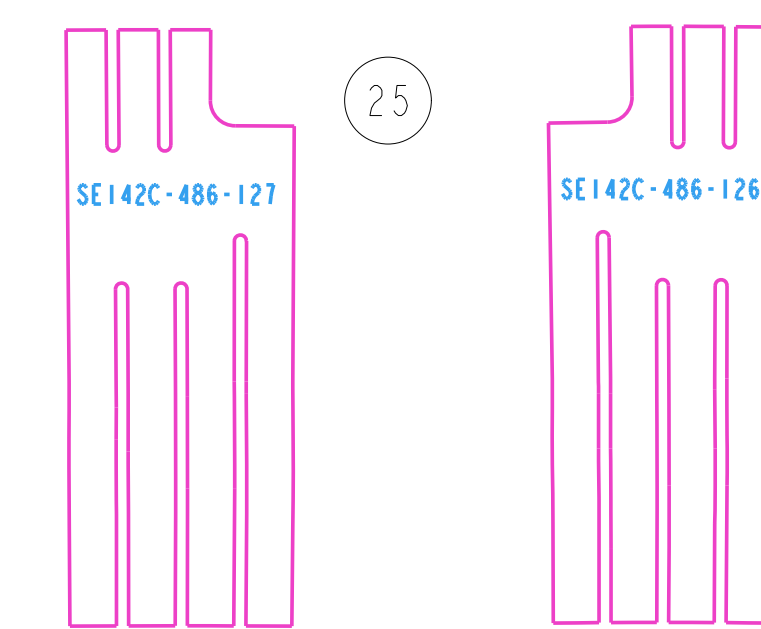

INSTANCE:
SE142C-486_FLAT_127

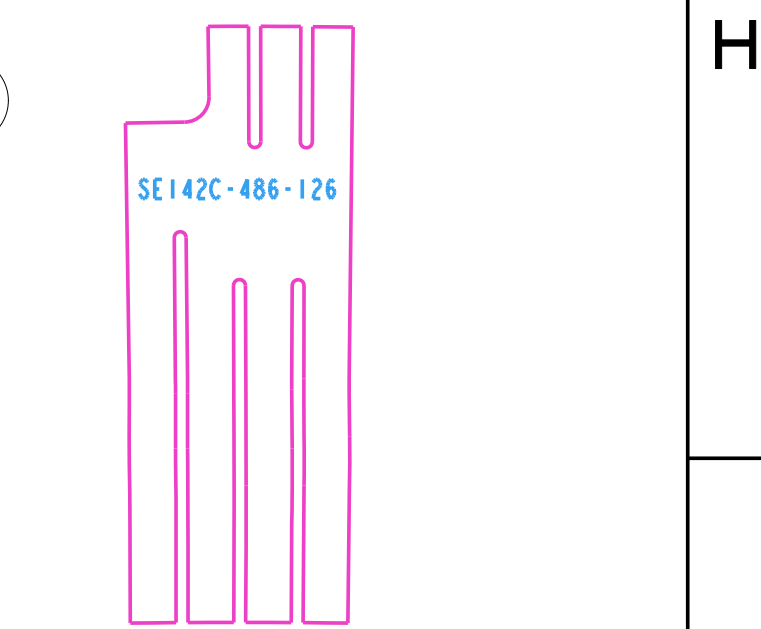

INSTANCE:
SE142C-486_FLAT_126

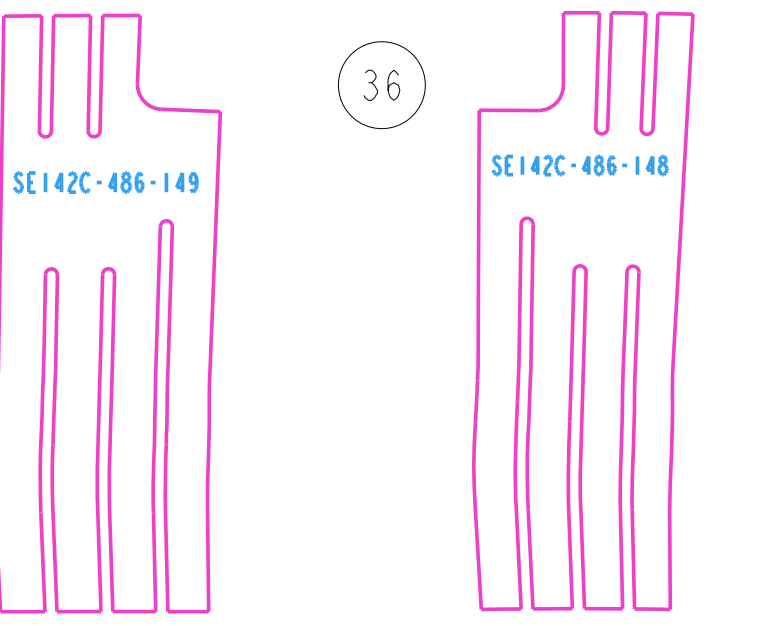

INSTANCE:
SE142C-486_FLAT_149

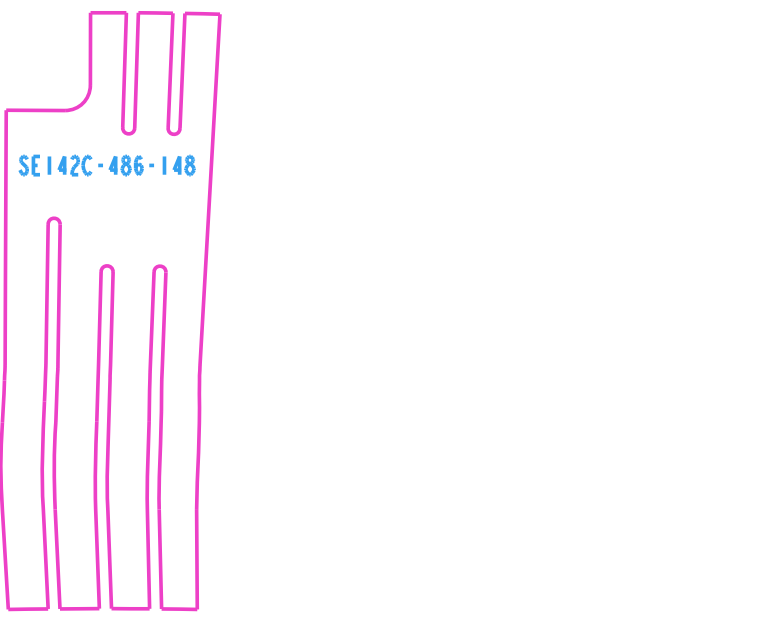

INSTANCE:
SE142C-486_FLAT_148

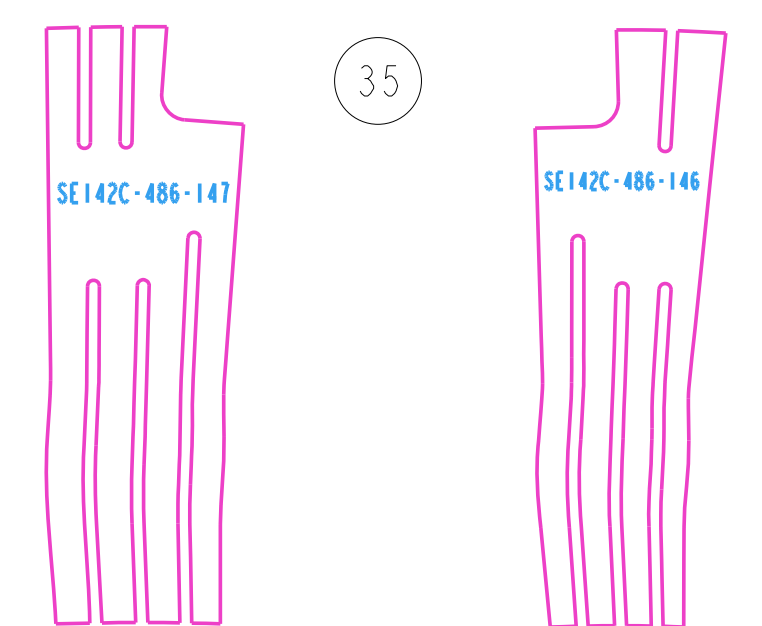

INSTANCE:
SE142C-486_FLAT_147

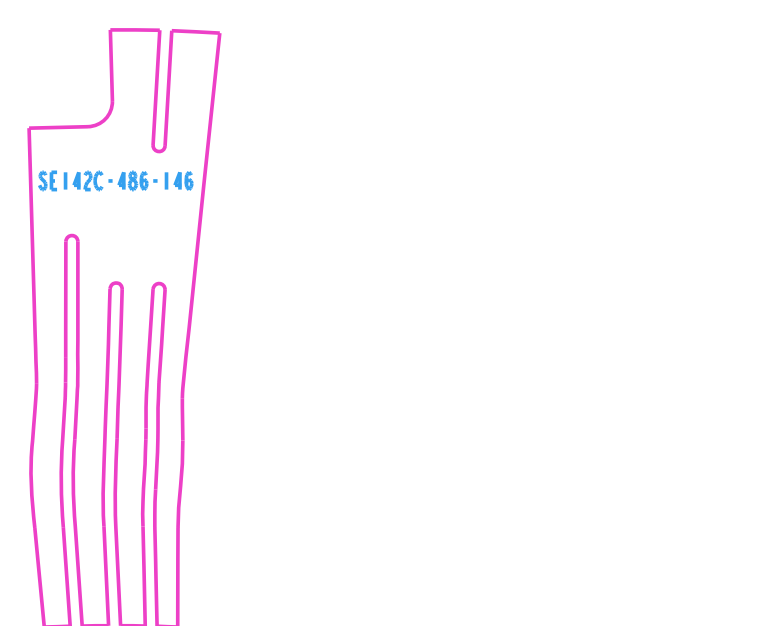

INSTANCE:
SE142C-486_FLAT_146-NEW

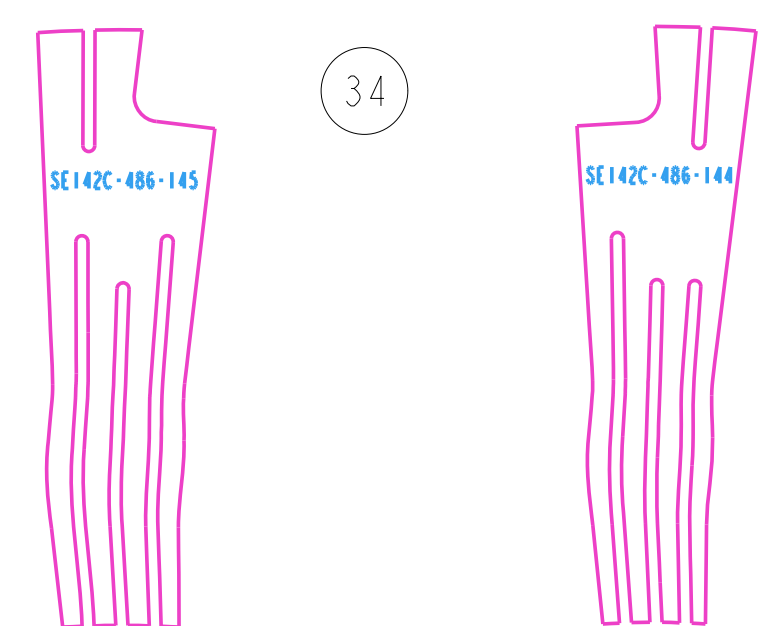

INSTANCE:
SE142C-486_FLAT_145-NEW

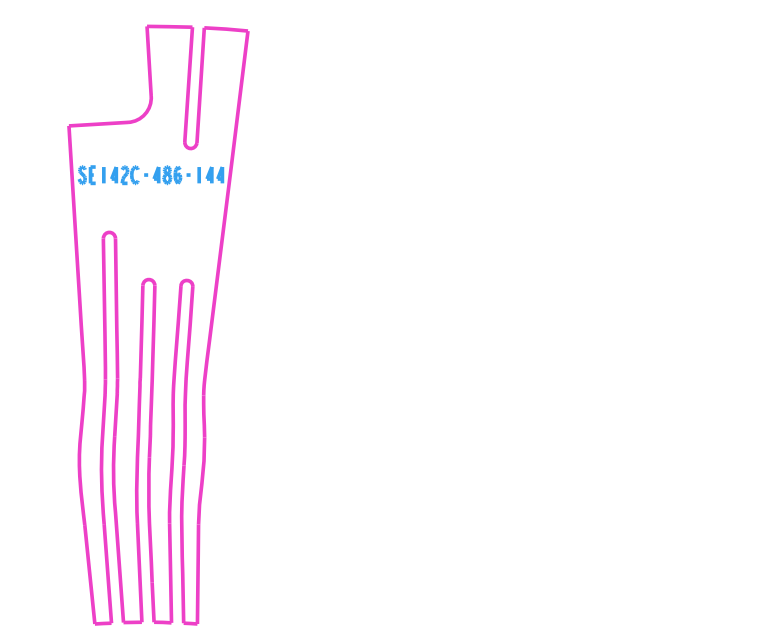

INSTANCE:
SE142C-486_FLAT_144-NEW

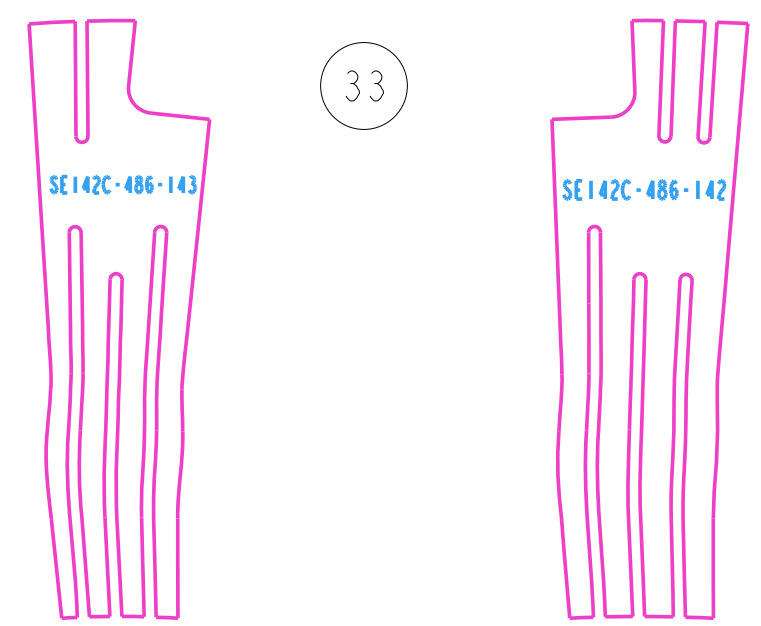

INSTANCE:
SE142C-486_FLAT_143-NEW

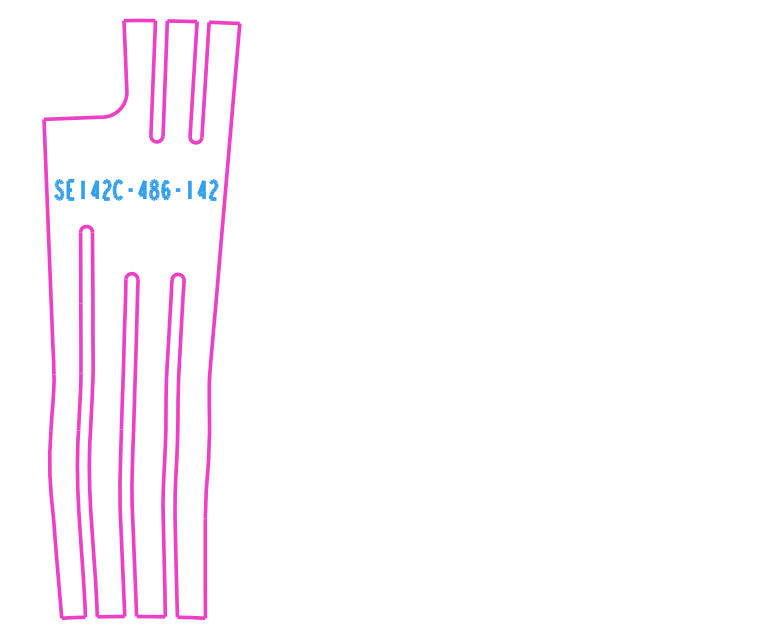

INSTANCE:
SE142C-486_FLAT_142

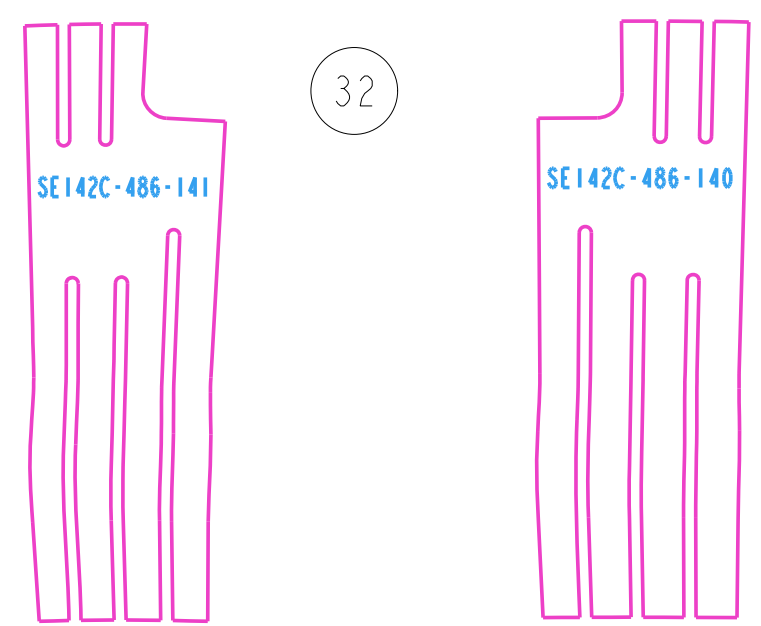

INSTANCE:
SE142C-486_FLAT_141

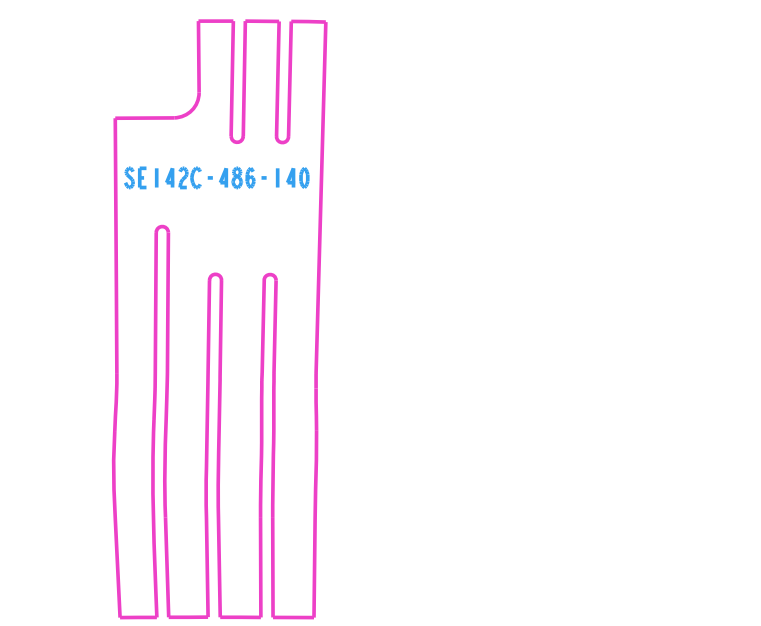

INSTANCE:
SE142C-486_FLAT_140

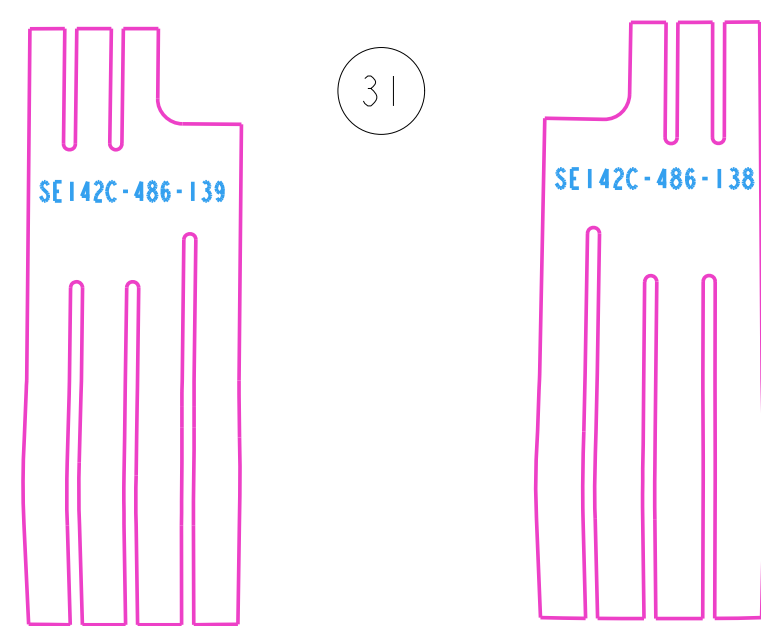

INSTANCE:
SE142C-486_FLAT_139

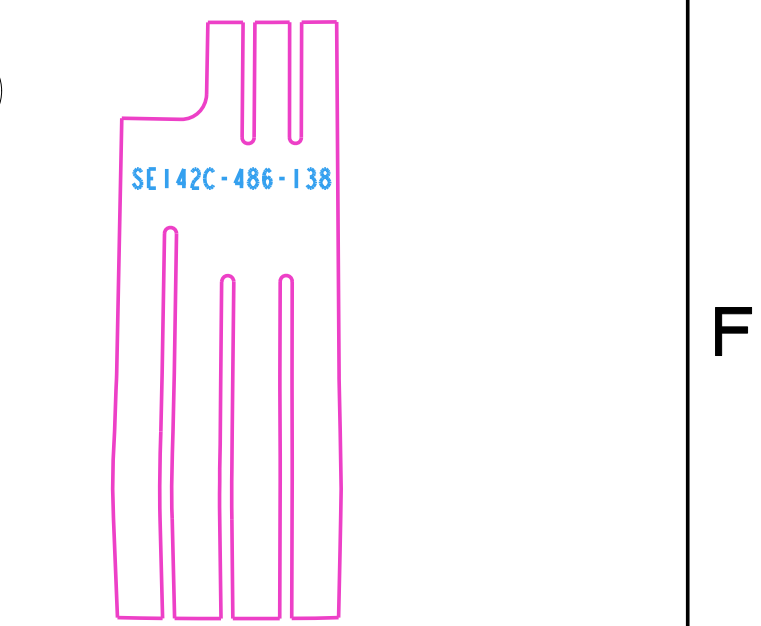

INSTANCE:
SE142C-486_FLAT_138

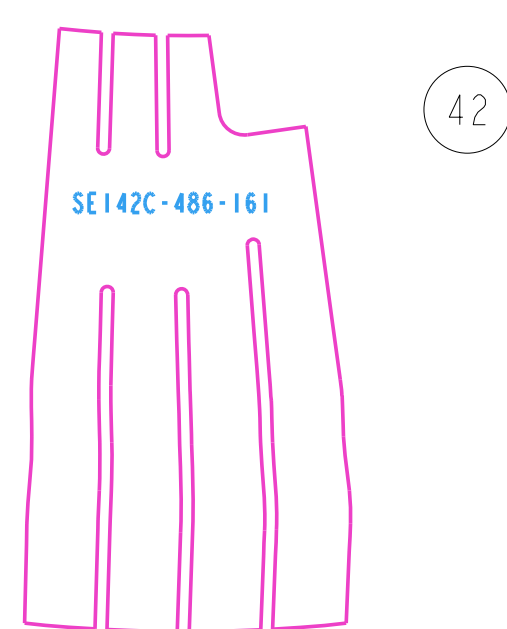

INSTANCE:
SE142C-486_FLAT_161

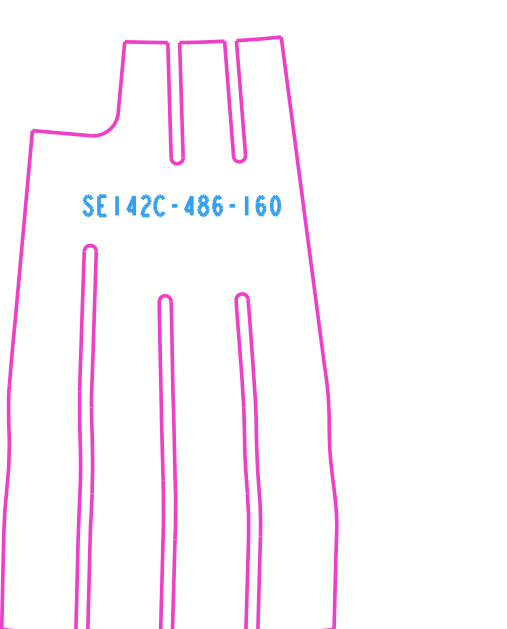

INSTANCE:
SE142C-486_FLAT_160

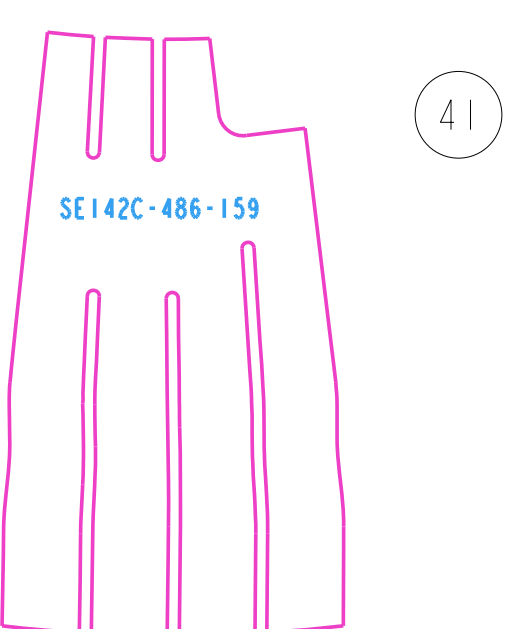

INSTANCE:
SE142C-486_FLAT_159

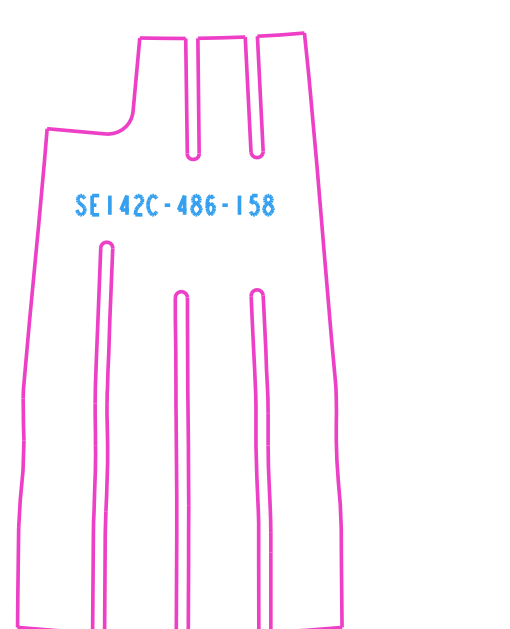

INSTANCE:
SE142C-486_FLAT_158

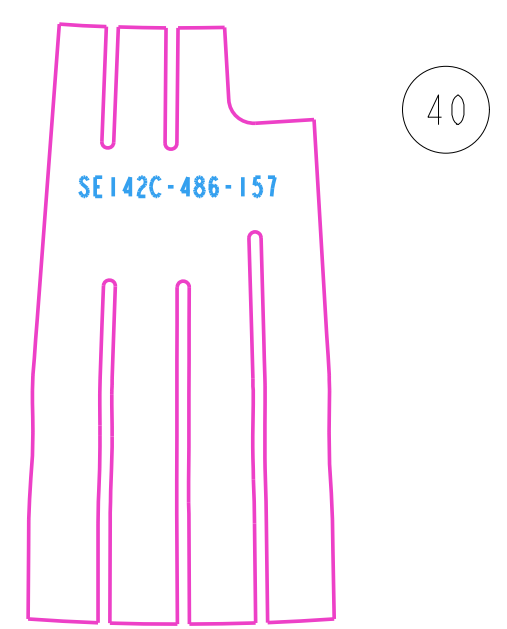

INSTANCE:
SE142C-486_FLAT_157

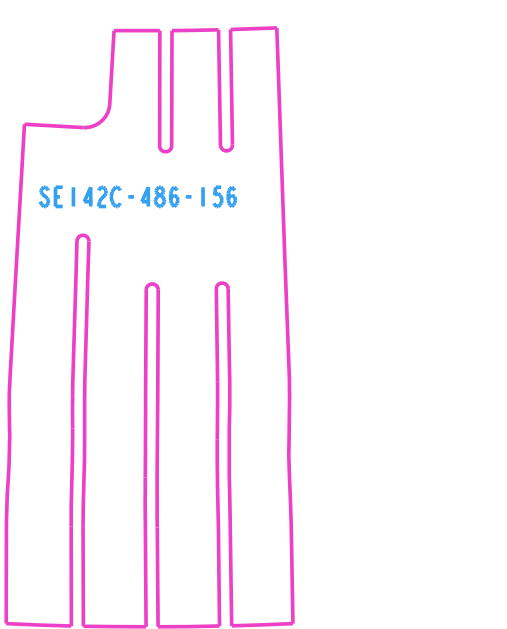

INSTANCE:
SE142C-486_FLAT_156

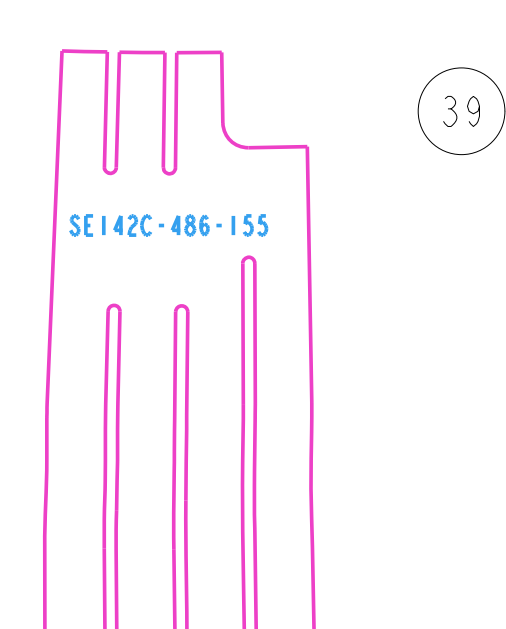

INSTANCE:
SE142C-486_FLAT_155

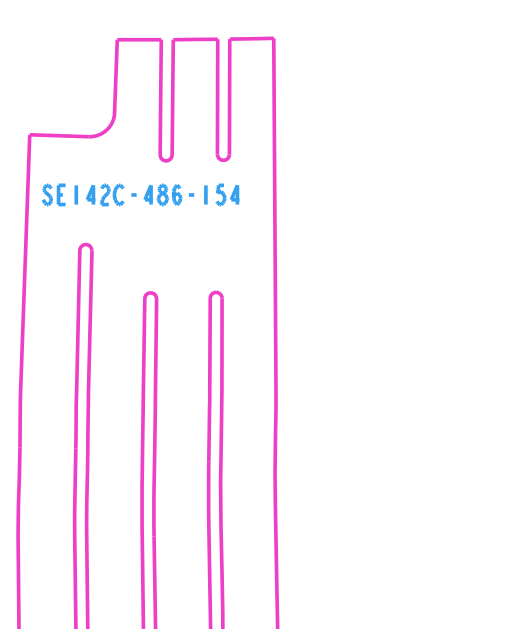

INSTANCE:
SE142C-486_FLAT_154

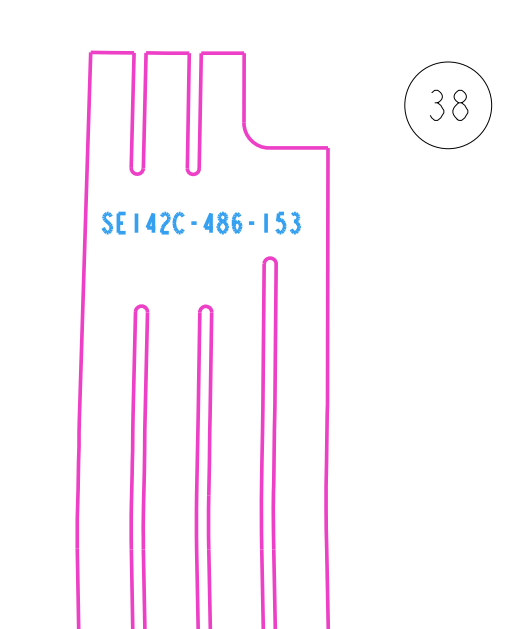

INSTANCE:
SE142C-486_FLAT_153

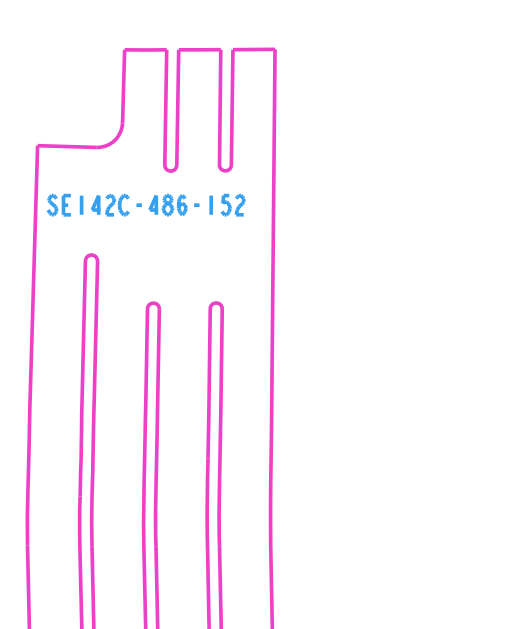

INSTANCE:
SE142C-486_FLAT_152

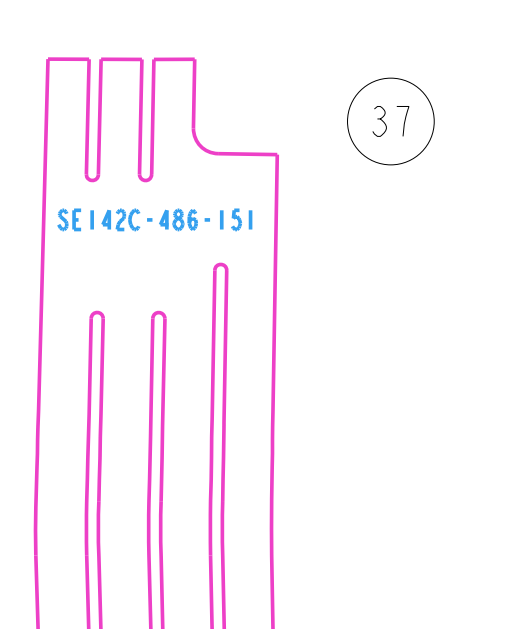

INSTANCE:
SE142C-486_FLAT_151

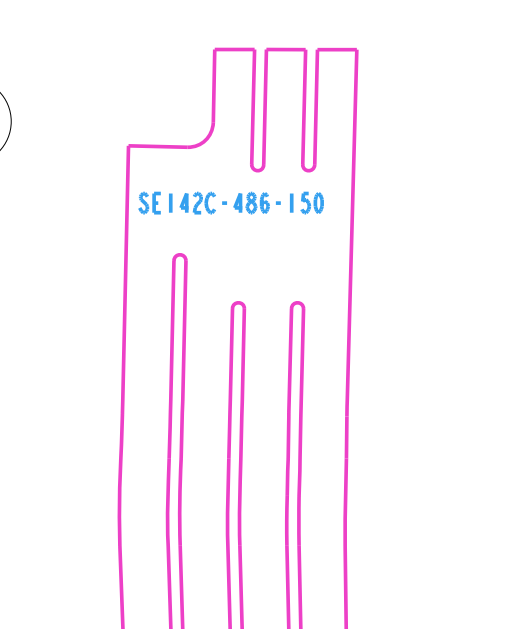

INSTANCE:
SE142C-486_FLAT_150

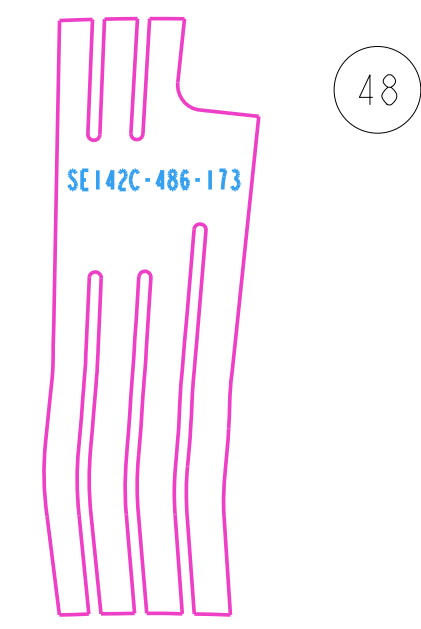

INSTANCE:
SE142C-486_FLAT_173

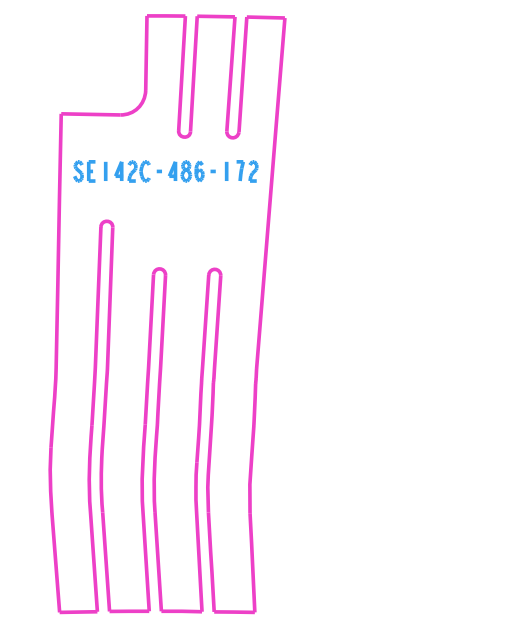

INSTANCE:
SE142C-486_FLAT_172

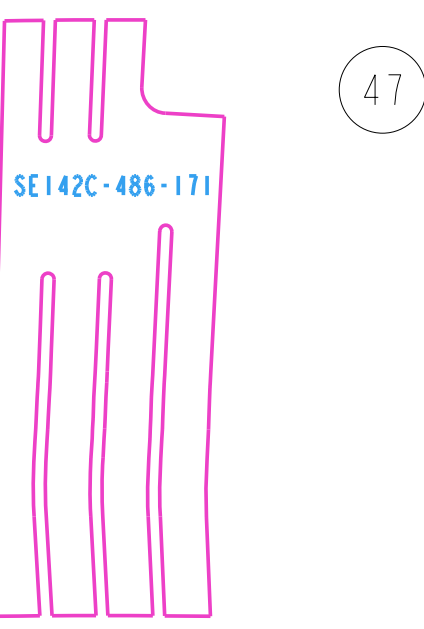

INSTANCE:
SE142C-486_FLAT_171

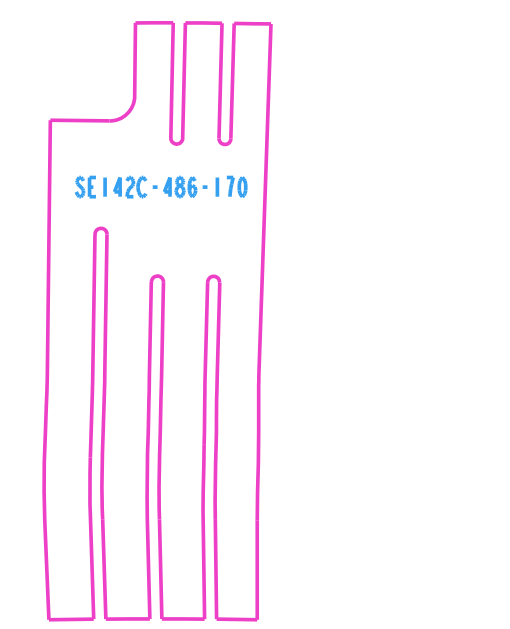

INSTANCE:
SE142C-486_FLAT_170

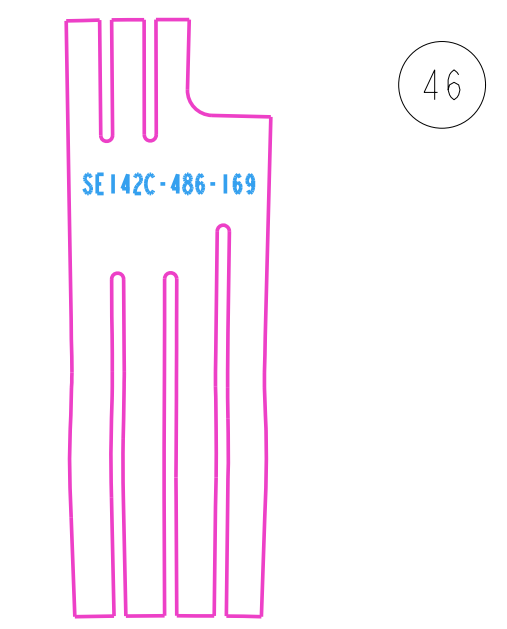

INSTANCE:
SE142C-486_FLAT_169

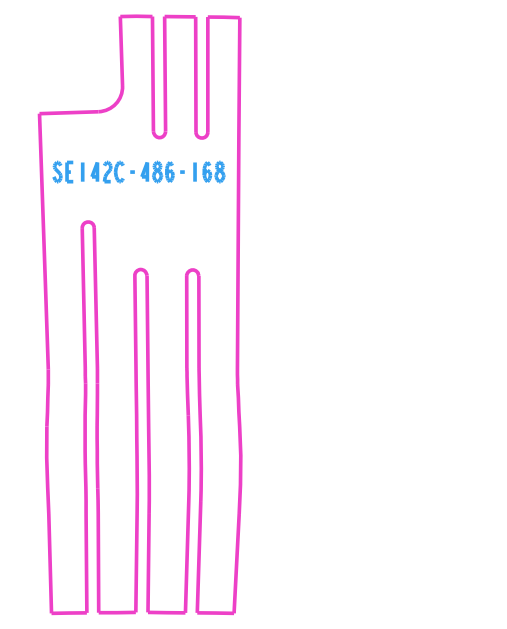

INSTANCE:
SE142C-486_FLAT_168

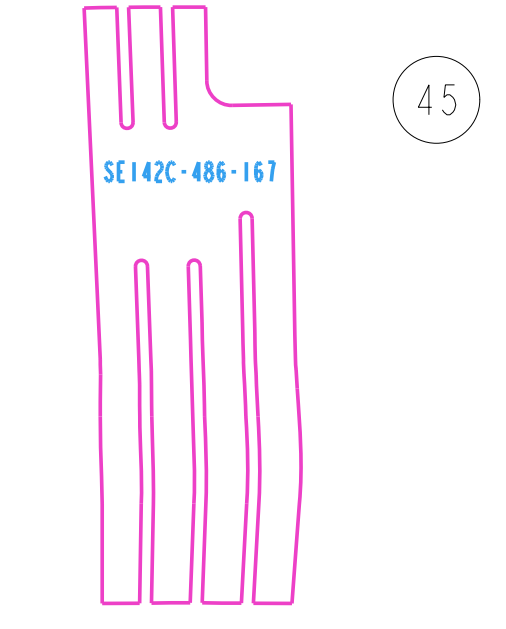

INSTANCE:
SE142C-486_FLAT_167

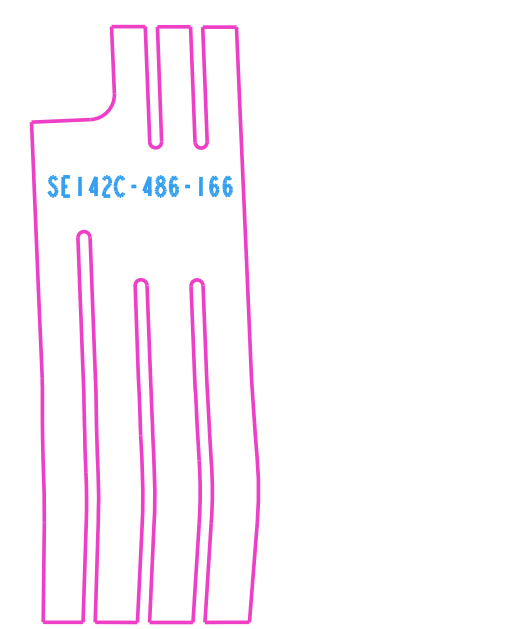

INSTANCE:
SE142C-486_FLAT_166

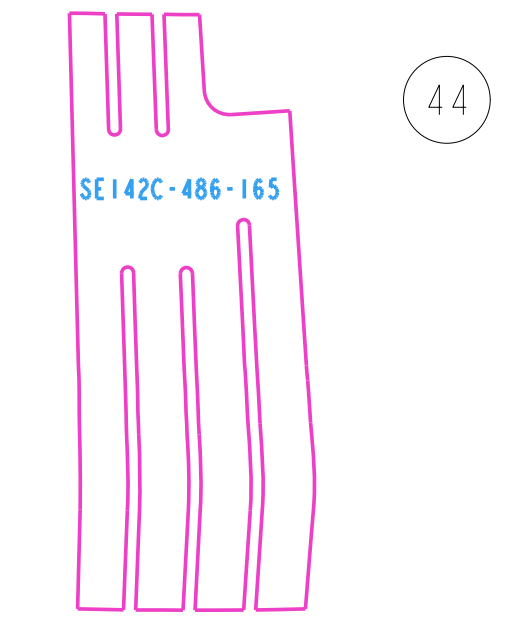

INSTANCE:
SE142C-486_FLAT_165

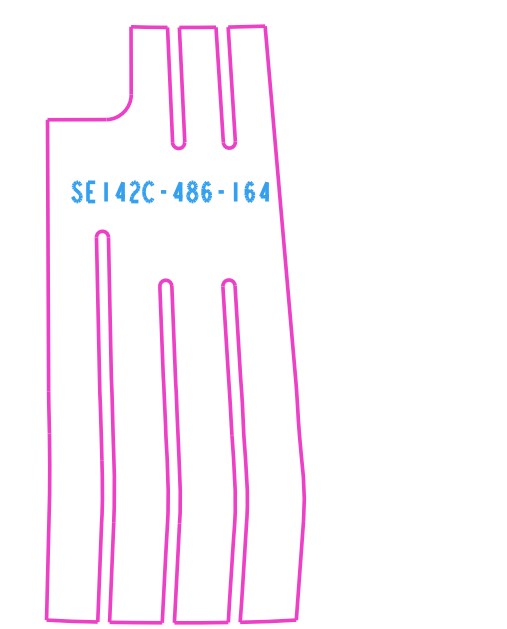

INSTANCE:
SE142C-486_FLAT_164

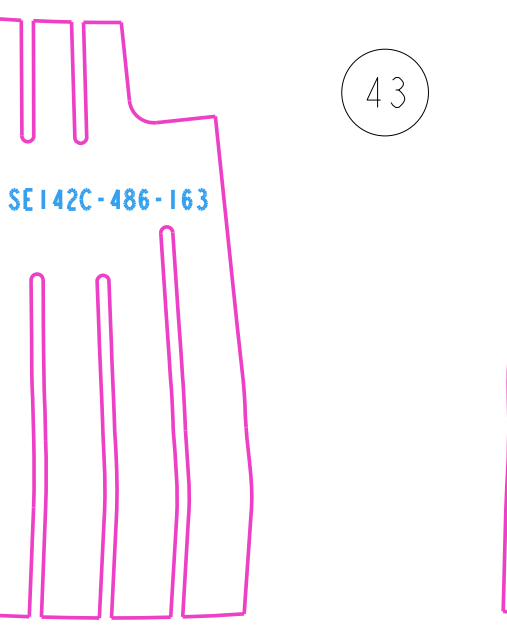

INSTANCE:
SE142C-486_FLAT_163

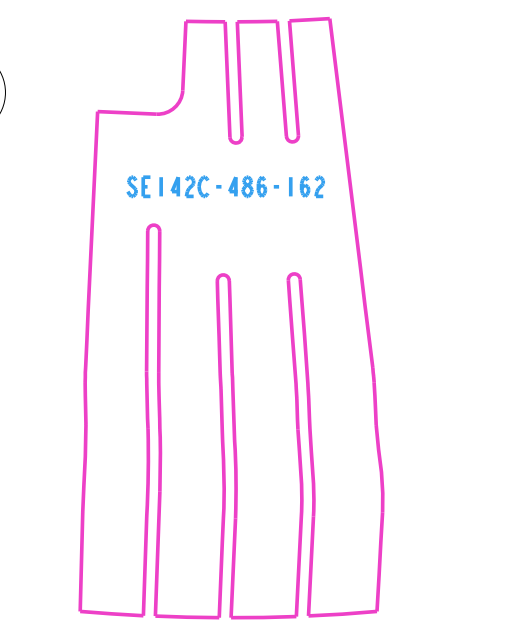

INSTANCE:
SE142C-486_FLAT_162

SCALE ALL VIEWS: 1.00

RELEASED FOR FABRICATION / INSTALLATION
PPPL Drafting:

Oak Ridge National Laboratory managed for the DEPARTMENT OF ENERGY under U.S. GOVERNMENT contract DE-AC05-00OR22725 UT-BATTELLE, LLC, Oak Ridge, Tennessee PROJECT NAME:						
NATIONAL COMPACT STELLARATOR EXPERIMENT MODULAR COIL TYPE - C SIDE -B UPPER (TOP) CHILL PLATES FLAT PATTERN LAYOUT						
VERSION NO.	PLANT	BLDG	FL	SHT OF	TYPE	CLASS
8	X-10	5700	3	3	S	U
RELEASE LEVEL		REV				
Fabrication		SE142C-486 0				

SE142C-486



SCALE ALL VIEWS: 1.00

**RELEASED FOR
 FABRICATION / INSTALLATION**
 PPPL Drafting:

Oak Ridge National Laboratory managed for the DEPARTMENT OF ENERGY under U.S. GOVERNMENT contract DE-AC05-00OR22725 UT-BATTELLE, LLC. Oak Ridge, Tennessee PROJECT NAME:						
NATIONAL COMPACT STELLARATOR EXPERIMENT MODULAR COIL TYPE - C SIDE -B UPPER (TOP) CHILL PLATES FLAT PATTERN LAYOUT						
VERSION NO.	PLANT	BLDG	FL	SHT OF	TYPE	CLASS
8	X-10	5700	3	4	5	S
RELEASE LEVEL		REV				
Fabrication		SEI42C-486			U	
					0	

H
G
F
E
D
C
B
A

H
G
F
E
D
C
B
A

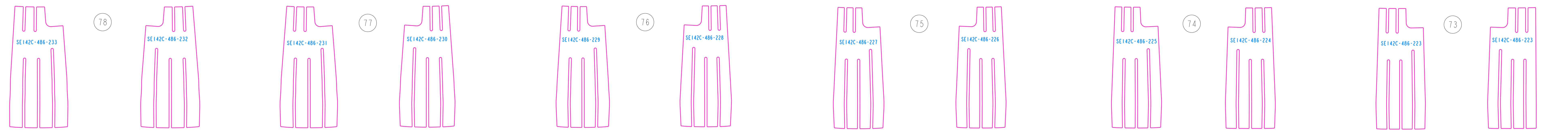

INSTANCE: SE142C-486_FLAT_233 INSTANCE: SE142C-486_FLAT_232 INSTANCE: SE142C-486_FLAT_231 INSTANCE: SE142C-486_FLAT_230 INSTANCE: SE142C-486_FLAT_229 INSTANCE: SE142C-486_FLAT_228 INSTANCE: SE142C-486_FLAT_227 INSTANCE: SE142C-486_FLAT_226 INSTANCE: SE142C-486_FLAT_225 INSTANCE: SE142C-486_FLAT_224 INSTANCE: SE142C-486_FLAT_223 INSTANCE: SE142C-486_FLAT_222

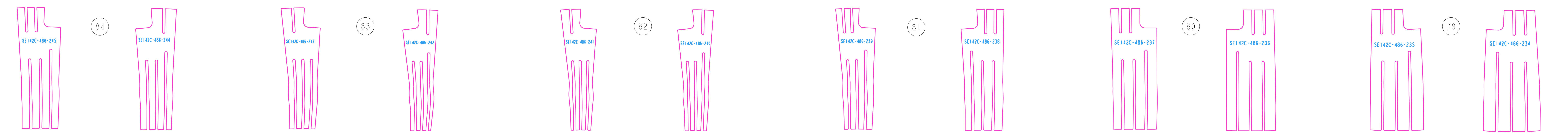

INSTANCE: SE142C-486_FLAT_245 INSTANCE: SE142C-486_FLAT_244-NEW INSTANCE: SE142C-486_FLAT_243-NEW INSTANCE: SE142C-486_FLAT_242-NEW INSTANCE: SE142C-486_FLAT_241-NEW INSTANCE: SE142C-486_FLAT_240-NEW INSTANCE: SE142C-486_FLAT_239 INSTANCE: SE142C-486_FLAT_238 INSTANCE: SE142C-486_FLAT_237 INSTANCE: SE142C-486_FLAT_236 INSTANCE: SE142C-486_FLAT_235 INSTANCE: SE142C-486_FLAT_234

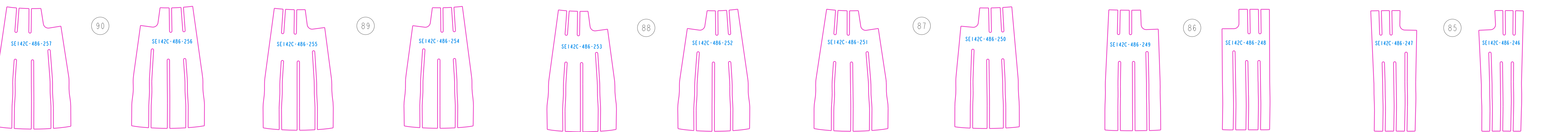

INSTANCE: SE142C-486_FLAT_257 INSTANCE: SE142C-486_FLAT_256 INSTANCE: SE142C-486_FLAT_255 INSTANCE: SE142C-486_FLAT_254 INSTANCE: SE142C-486_FLAT_253 INSTANCE: SE142C-486_FLAT_252 INSTANCE: SE142C-486_FLAT_251 INSTANCE: SE142C-486_FLAT_250 INSTANCE: SE142C-486_FLAT_249 INSTANCE: SE142C-486_FLAT_248 INSTANCE: SE142C-486_FLAT_247 INSTANCE: SE142C-486_FLAT_246

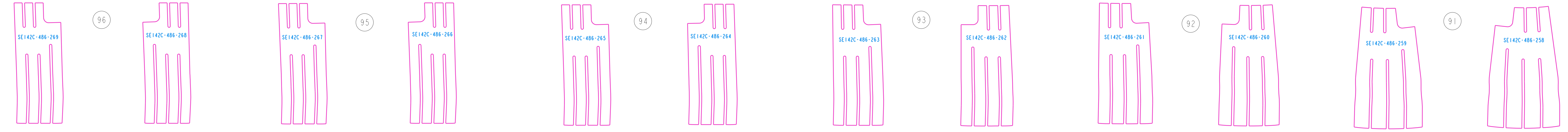

INSTANCE: SE142C-486_FLAT_269 INSTANCE: SE142C-486_FLAT_268 INSTANCE: SE142C-486_FLAT_267 INSTANCE: SE142C-486_FLAT_266 INSTANCE: SE142C-486_FLAT_265 INSTANCE: SE142C-486_FLAT_264 INSTANCE: SE142C-486_FLAT_263 INSTANCE: SE142C-486_FLAT_262 INSTANCE: SE142C-486_FLAT_261 INSTANCE: SE142C-486_FLAT_260 INSTANCE: SE142C-486_FLAT_259 INSTANCE: SE142C-486_FLAT_258

RELEASED FOR FABRICATION / INSTALLATION
PPPL Drafting:

SCALE ALL VIEWS: 1.00

UT-BATTELLE Oak Ridge National Laboratory managed for the DEPARTMENT OF ENERGY under U.S. GOVERNMENT contract DE-AC05-00OR22725 UT-BATTELLE, LLC. Oak Ridge, Tennessee PROJECT NAME:						
NATIONAL COMPACT STELLARATOR EXPERIMENT MODULAR COIL TYPE - C SIDE -B UPPER (TOP) CHILL PLATES FLAT PATTERN LAYOUT						
VERSION NO.	PLANT	BLDG	FL	SHT OF	TYPE	CLASS
8	X-10	5700	3	5	S	U
RELEASE LEVEL		SE142C-486		REV 0		
Fabrication						

SE142C-486