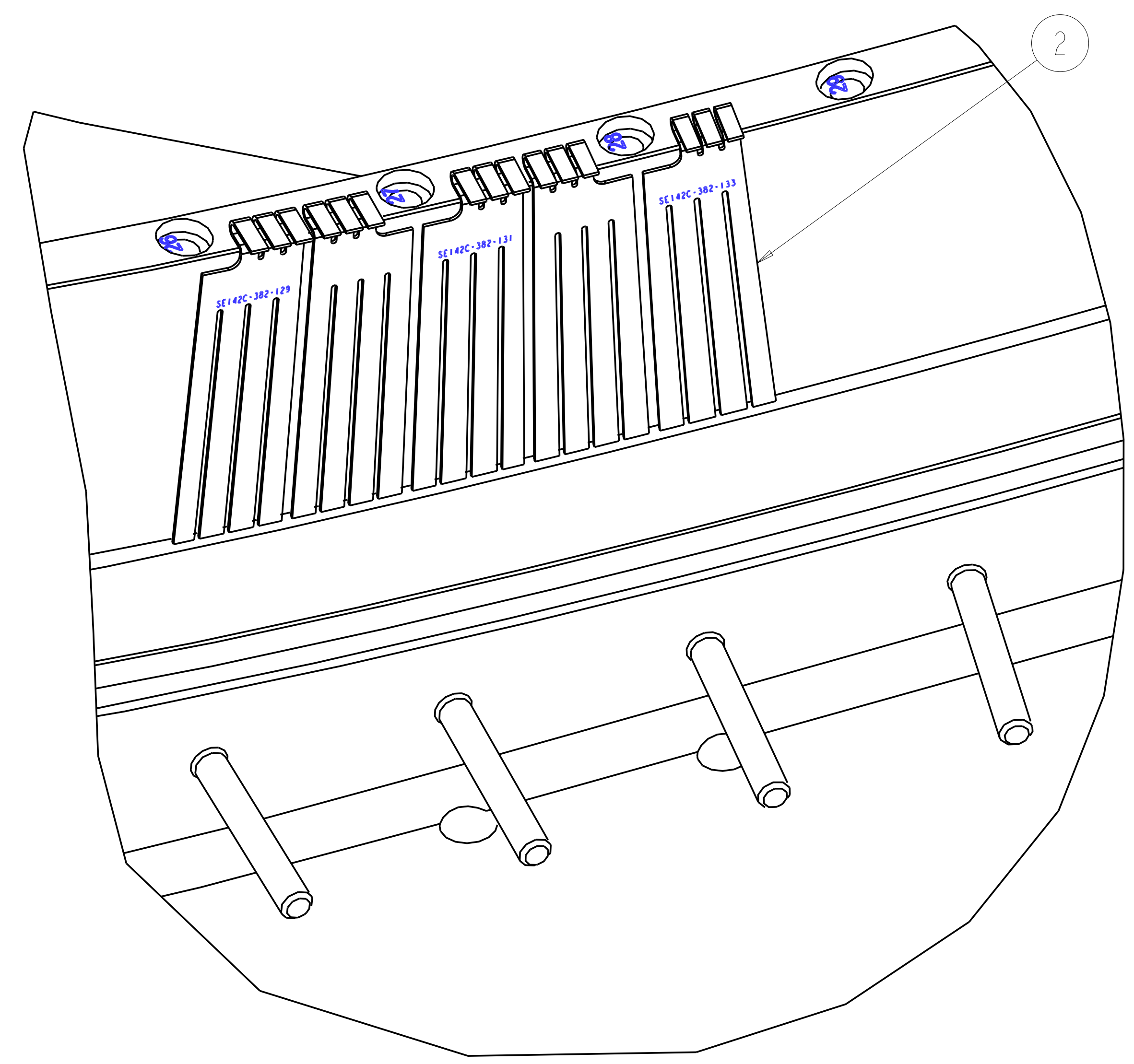

Table with 4 columns: INSTANCE NAME, HOLE, S-DIM, PART NAME. Lists parts from SEI42C-382-270 to SEI42C-382-174.

- NOTES:
1. DRAWING PREPARED IN ACCORDANCE WITH ASME Y14.8M-1996.
2. INTERPRET DIMENSIONS AND TOLERANCES PER ANSI Y14.5M-1994.
3. DIMENSIONS ARE IN INCHES.
4. DRAWING DEPICTS FLAT PATTERN OF FORMED PARTS DEFINED BY PRO/ENGINEER FILES SEI42C-382-XXX-FORM.PRT.
5. PROFILE TOLERANCE OF FLAT PATTERN IS +/- .010-IN
6. REMOVE ALL BURRS AND SHARP EDGES.
7. IDENTIFY PARTS BY ETCHING OR PERMANENT MARKER.



ISOMETRIC VIEW

RELEASED FOR FABRICATION / INSTALLATION
PPPL Drafting:

Table for PARTS LIST with columns: nextassy, AR X, CAGE CODE, PART OR IDENTIFYING NO, NOMENCLATURE OR DESCRIPTION, MATERIAL / SPECIFICATION, FIND NO.

Table with columns: REV, DESCRIPTION, BY, DATE, CHK, DEPT, DATE, PE, REG, DATE, DRNL, DOE, DATE. Includes drawing title 'MODULAR COIL TYPE-C SIDE-A UPPER CLADDING FLAT PATTERN LAYOUT' and drawing no 'SEI42C-382'.

NO REPRESENTATION OR WARRANTY EXPRESSED OR IMPLIED IS MADE AS TO THE ACCURACY, COMPLETENESS OR USEFULNESS OF THE INFORMATION OR STATEMENTS CONTAINED IN THESE DRAWINGS...

P THIS DRAWING PRODUCED ON PRO-ENGINEER

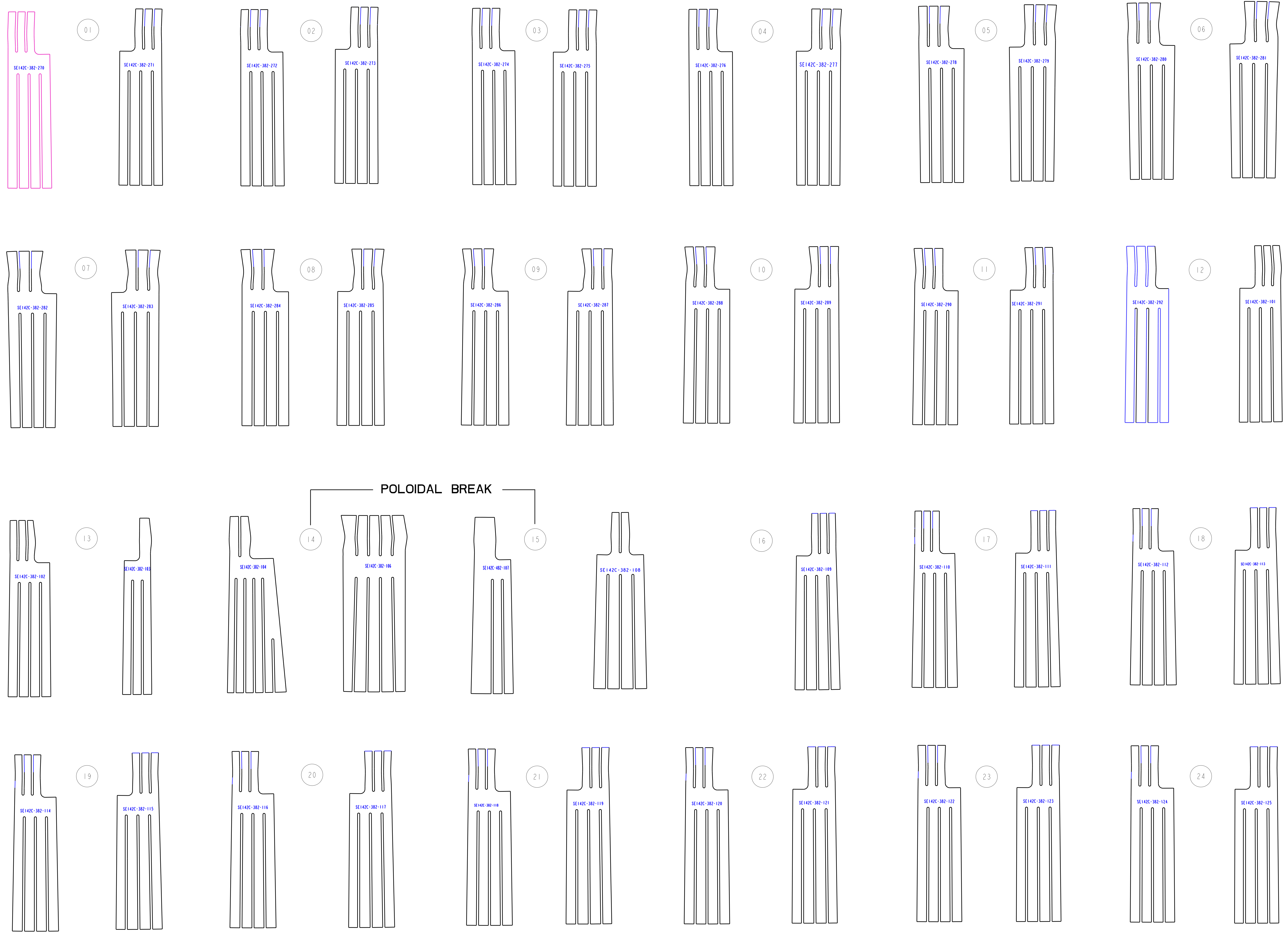

**RELEASED FOR  
FABRICATION / INSTALLATION**  
PPPL Drafting:

Oak Ridge National Laboratory managed for the DEPARTMENT OF ENERGY under U.S. GOVERNMENT contract DE-AC05-00OR22725 UT-BATTELLE, LLC, Oak Ridge, Tennessee <small>PROJECT NAME</small>							
<b>NATIONAL COMPACT STELLARATOR EXPERIMENT</b> MODULAR COIL TYPE-C SIDE-A UPPER CLADDING FLAT PATTERN LAYOUT							
VERSION NO.	PLANT	BLDG	FL	SHT	OF	TYPE	CLASS
7	X-10	5700	3	2	5	S	U
RELEASE LEVEL		REV					
Fabrication		SE142C-382					

H G F E D C B A

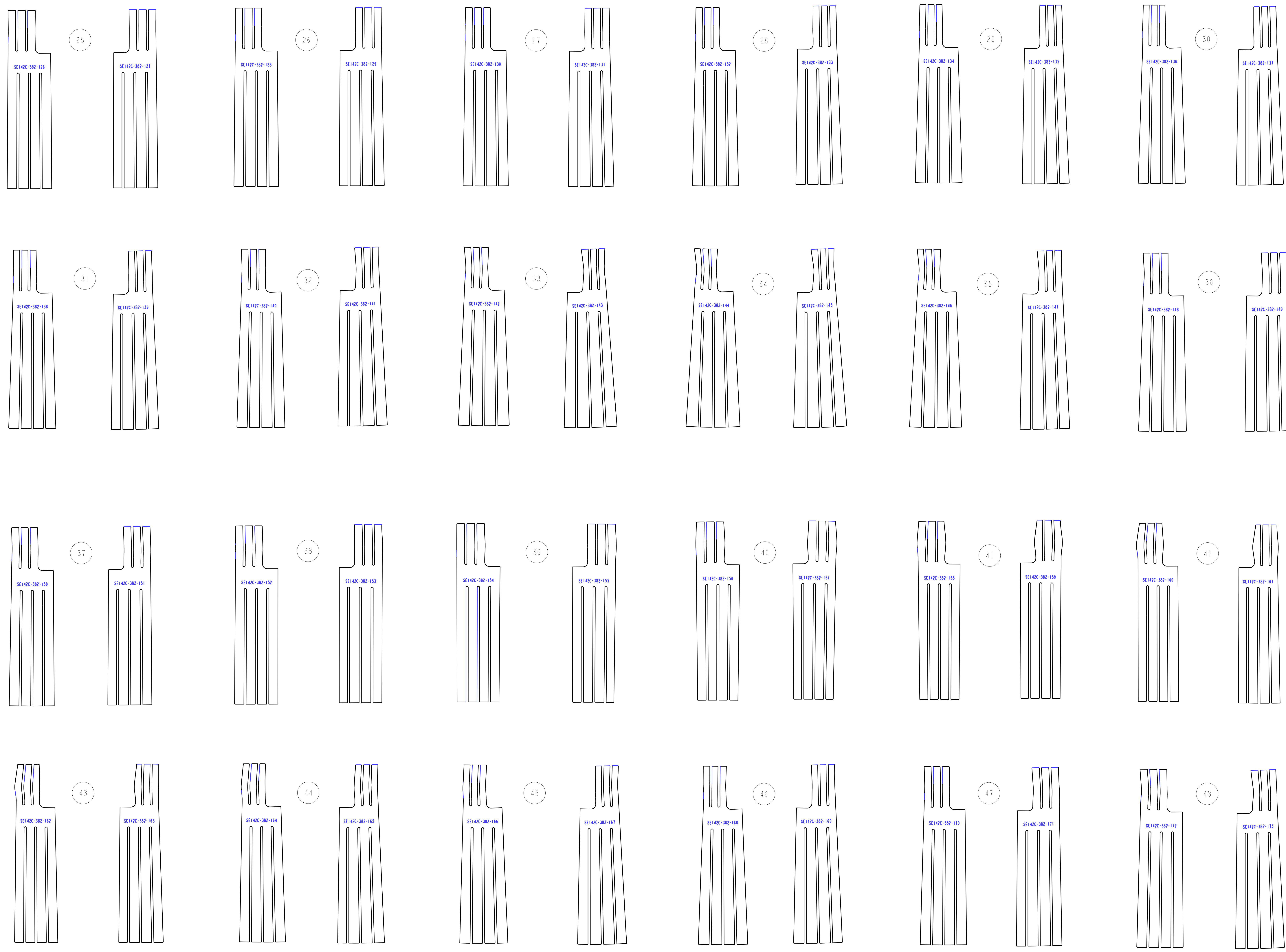

**RELEASED FOR  
FABRICATION / INSTALLATION**  
PPPL Drafting:

Oak Ridge National Laboratory managed for the DEPARTMENT OF ENERGY under U.S. GOVERNMENT contract DE-AC05-00OR22725 UT-BATTELLE, LLC, Oak Ridge, Tennessee							
<b>UT-BATTELLE</b> NATIONAL COMPACT STELLARATOR EXPERIMENT							
MODULAR COIL TYPE-C SIDE-A UPPER CLADDING FLAT PATTERN LAYOUT							
VERSION NO.	PLANT	BLDG	FL	SHT OF	TYPE	CLASS	
7	X-10	5700	3	3	S	U	
RELEASE LEVEL		REV					
Fabrication		SE142C-382					

SE142C-382

A

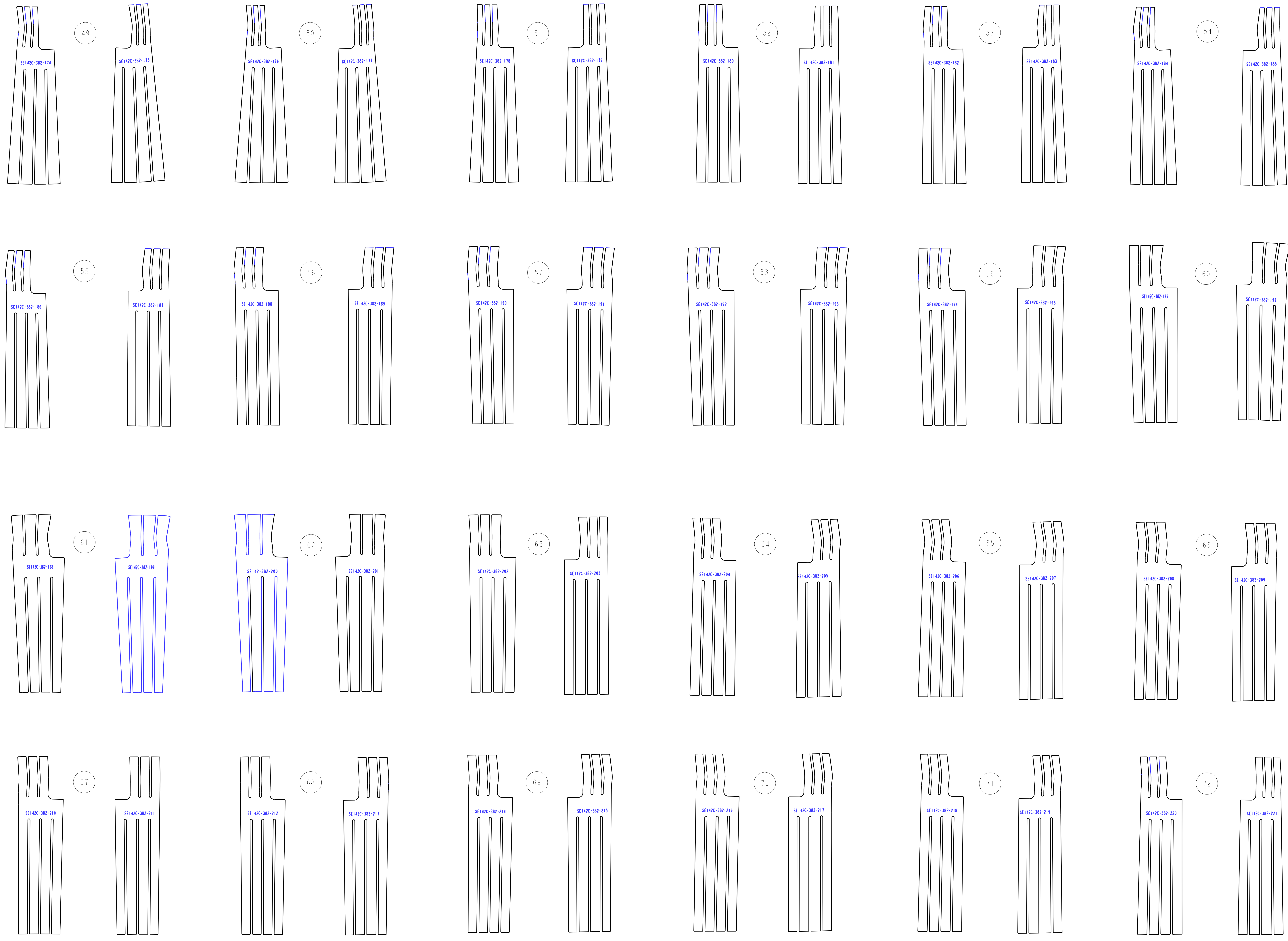

**RELEASED FOR  
FABRICATION / INSTALLATION**  
PPPL Drafting:

Oak Ridge National Laboratory managed for the DEPARTMENT OF ENERGY under U.S. GOVERNMENT contract DE-AC05-00OR22725 UT-BATTELLE, LLC, Oak Ridge, Tennessee							
<b>UT-BATTELLE</b> NATIONAL COMPACT STELLARATOR EXPERIMENT							
MODULAR COIL TYPE-C SIDE-A UPPER CLADDING FLAT PATTERN LAYOUT							
VERSION NO.	PLANT	BLDG	FL	SHT	OF	TYPE	CLASS
7	X-10	5700	3	4	5	S	U
RELEASE LEVEL		REV					
Fabrication		SE142C-382					

8

7

6

5

4

3

2

1

NEXT ASS'Y: FINAL ASS'Y:

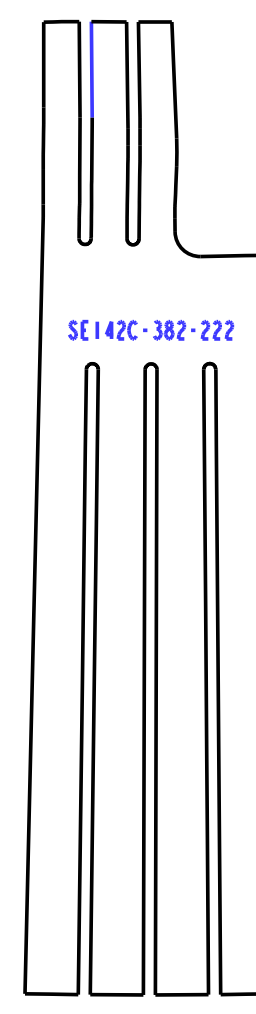

73

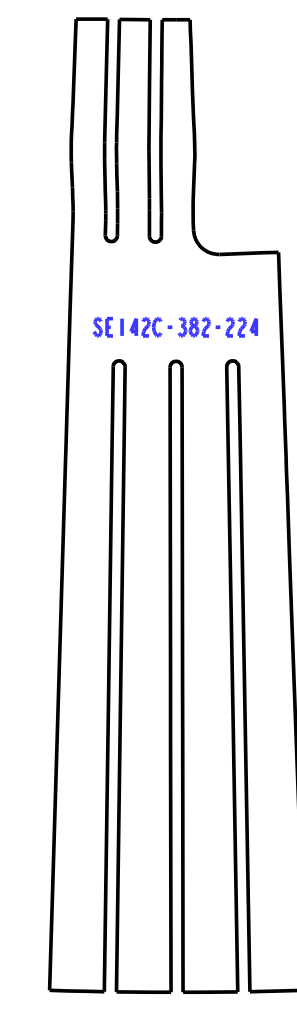
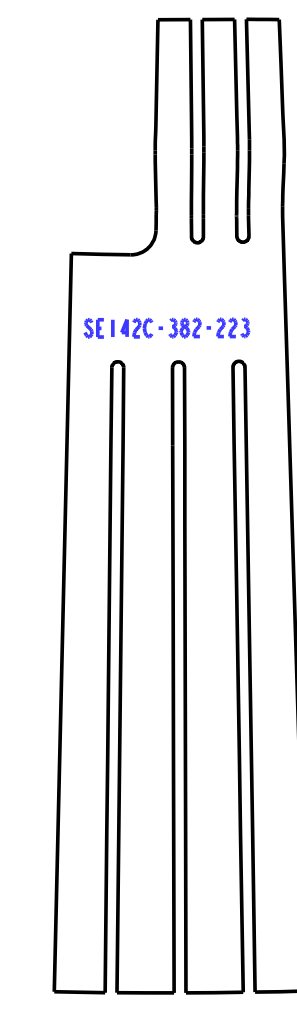

74

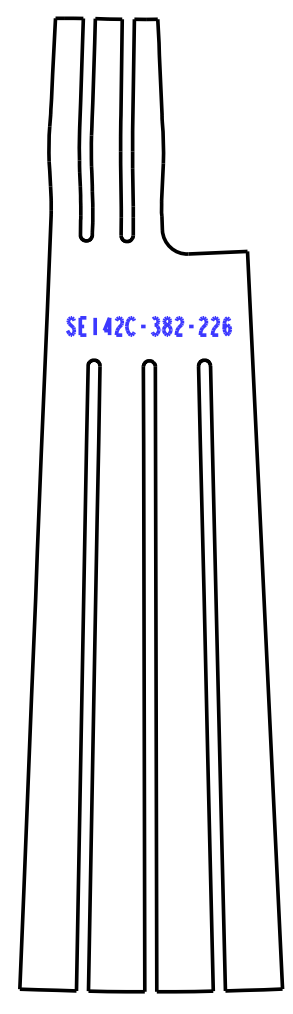
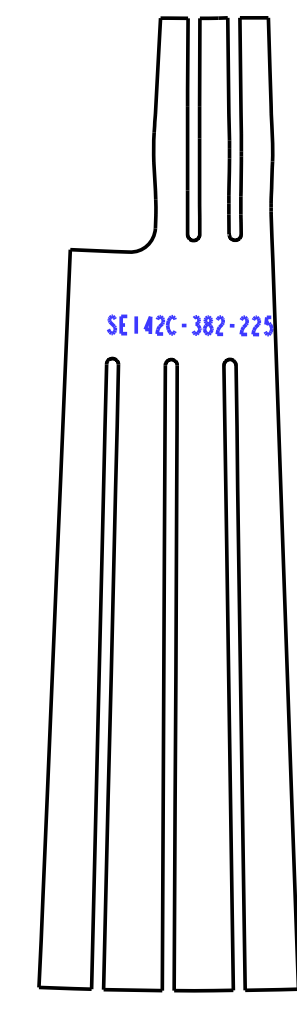

75

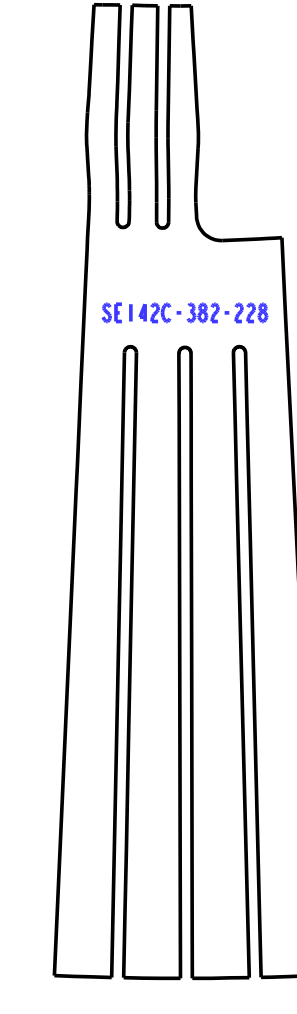
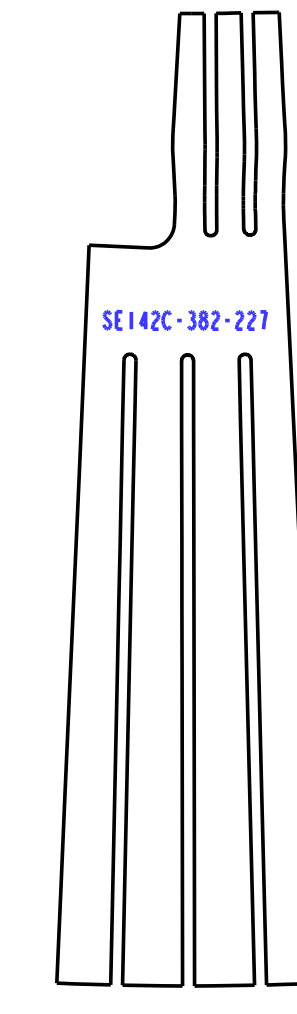

76

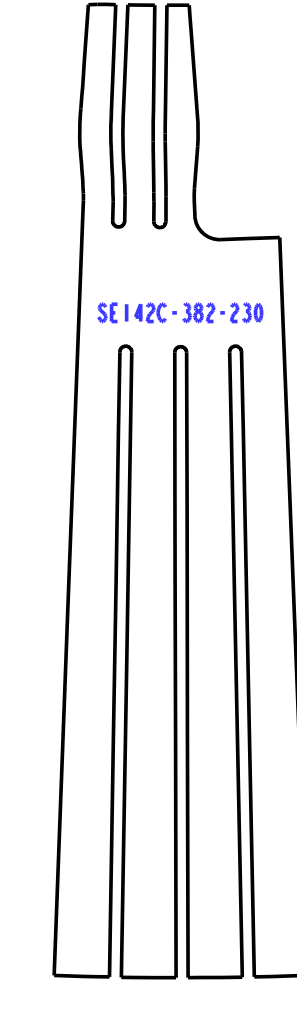
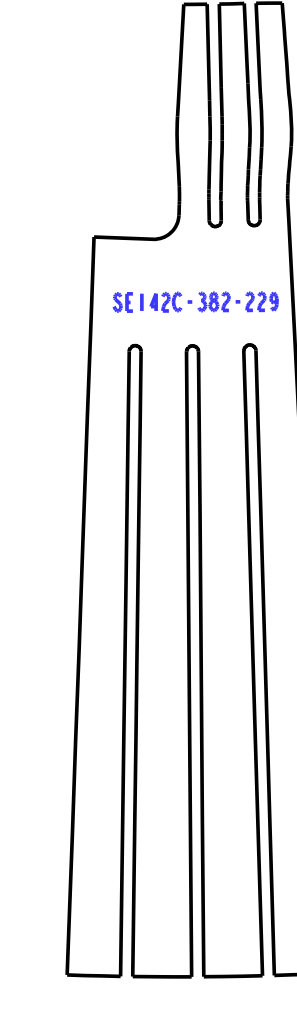

77

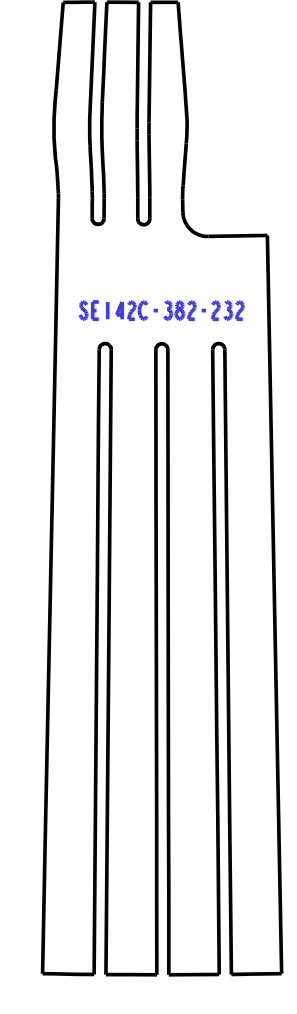
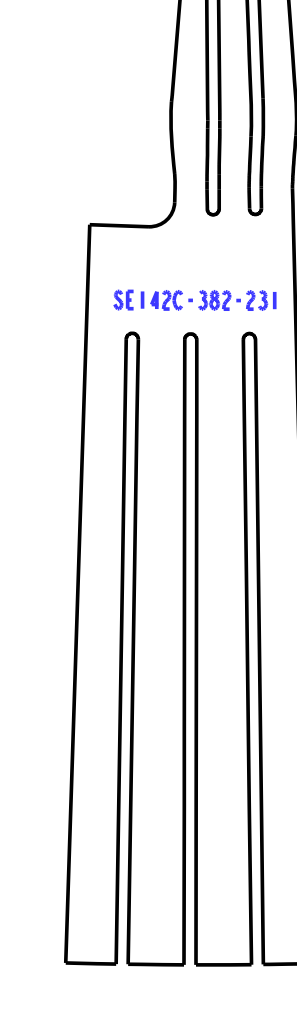

78

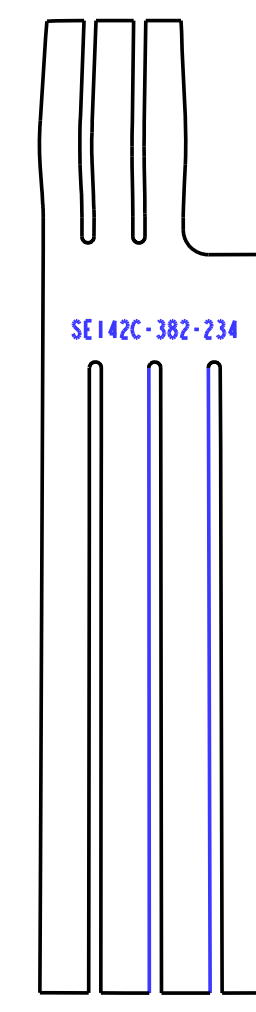
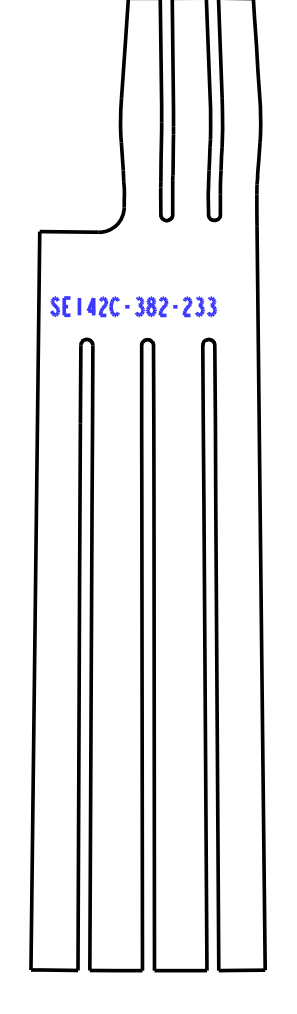

79

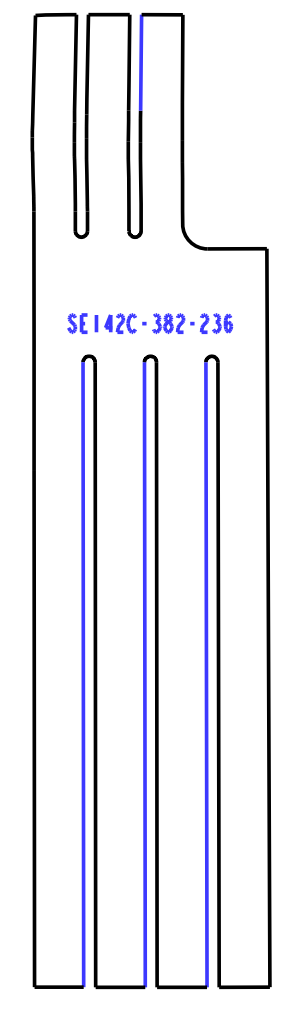
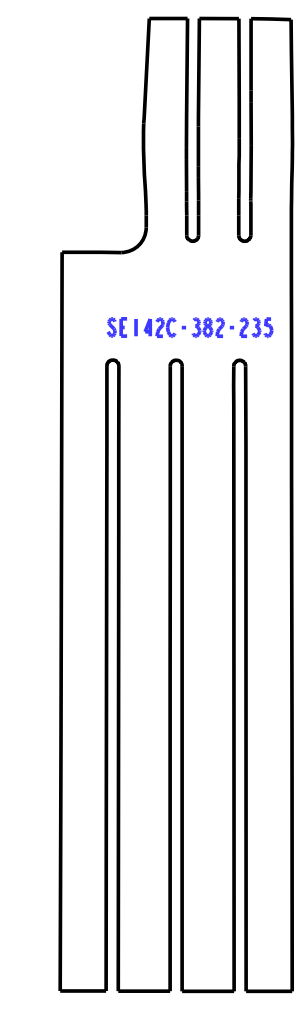

80

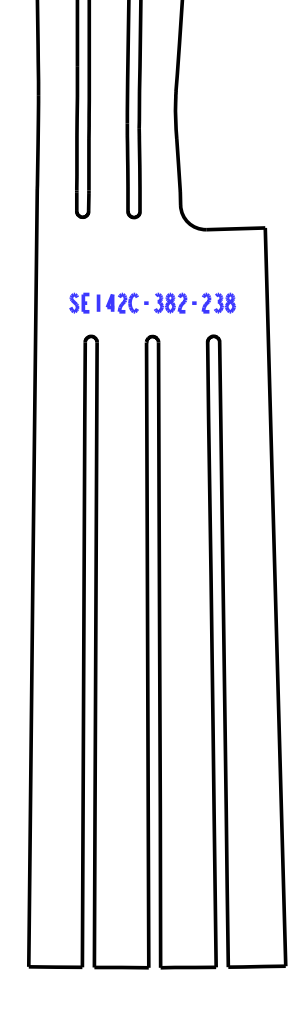
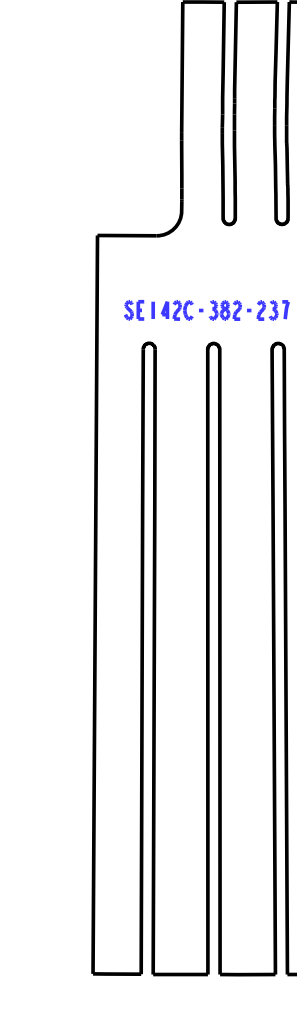

81

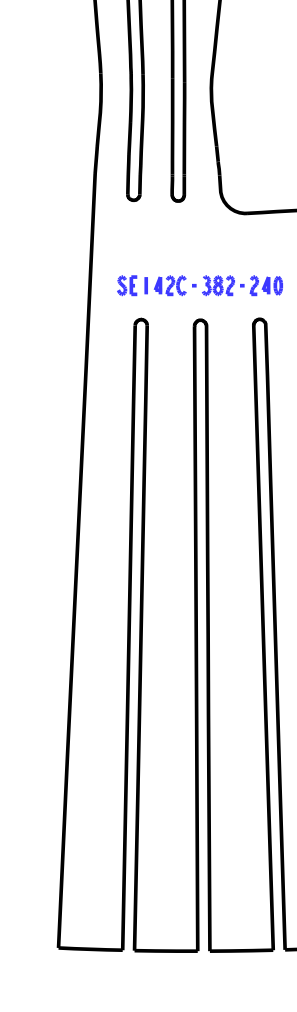
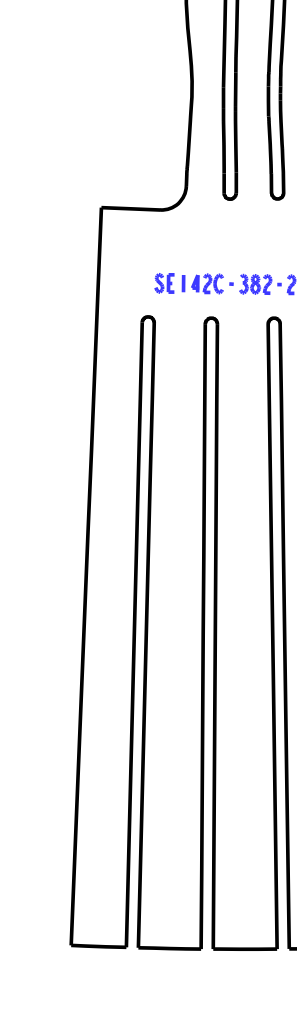

82

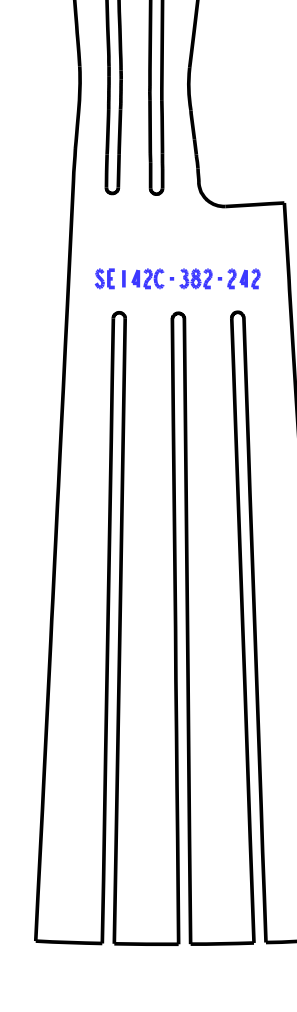
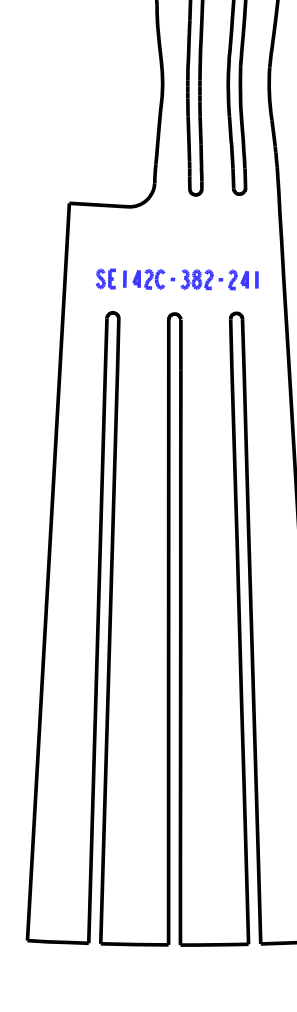

83

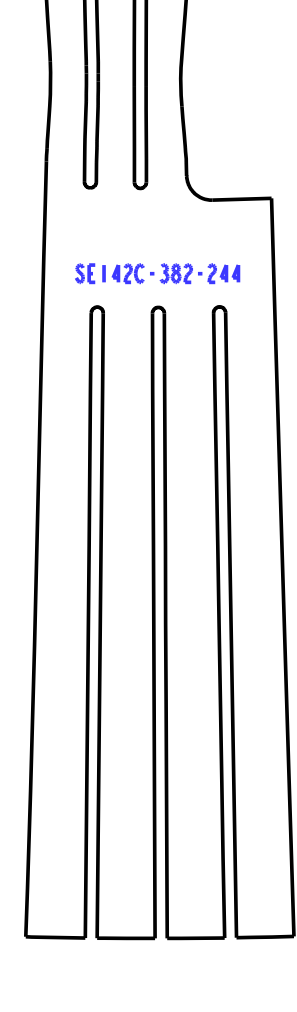
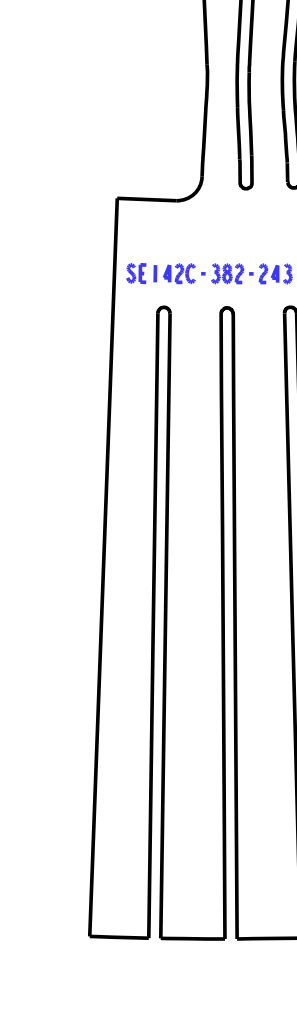

84

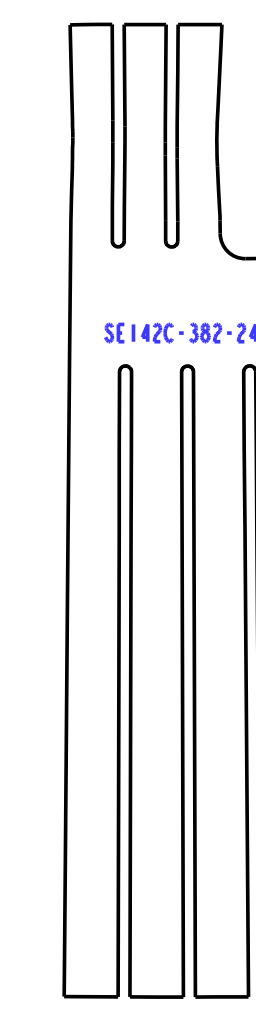
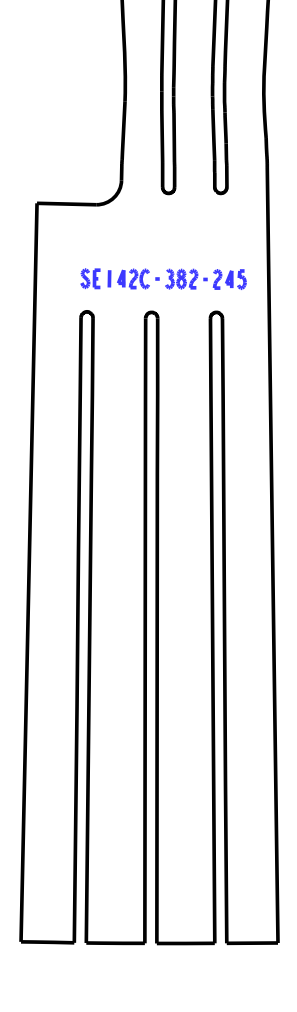

85

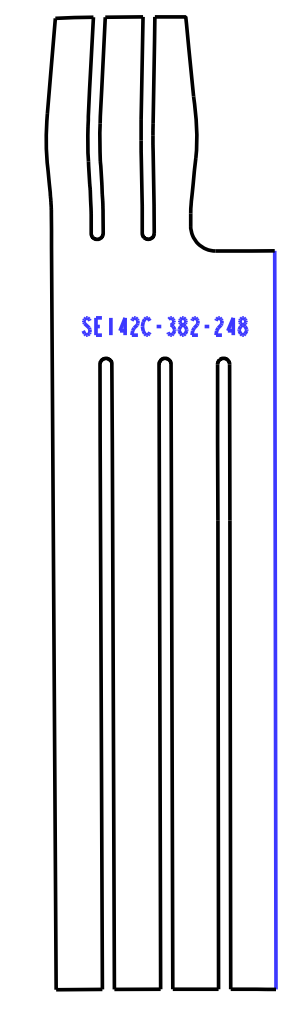
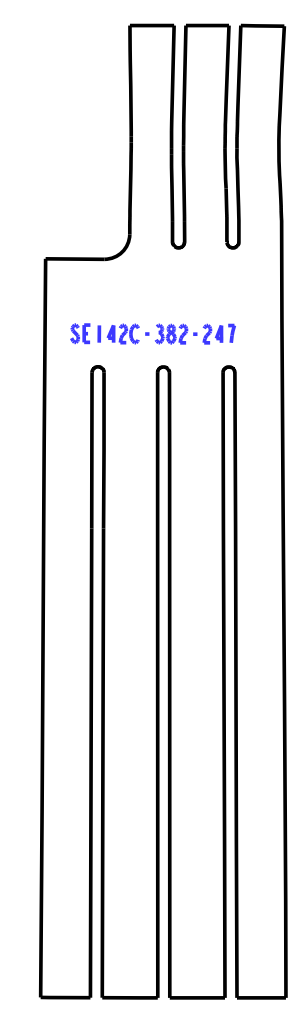

86

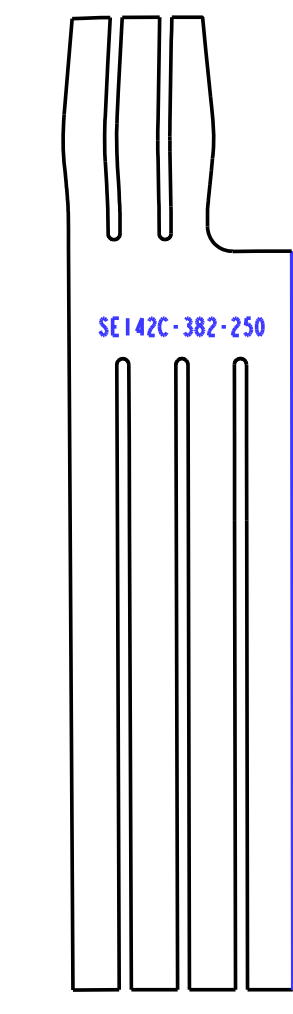
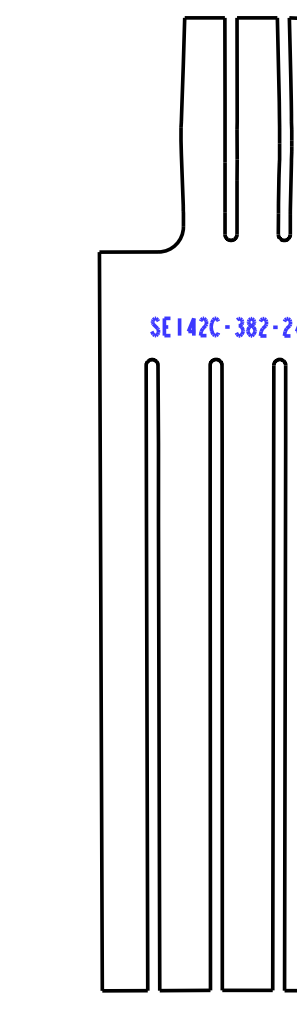

87

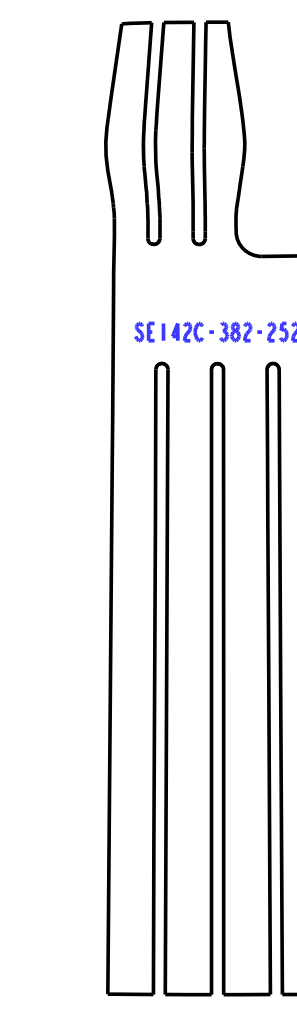
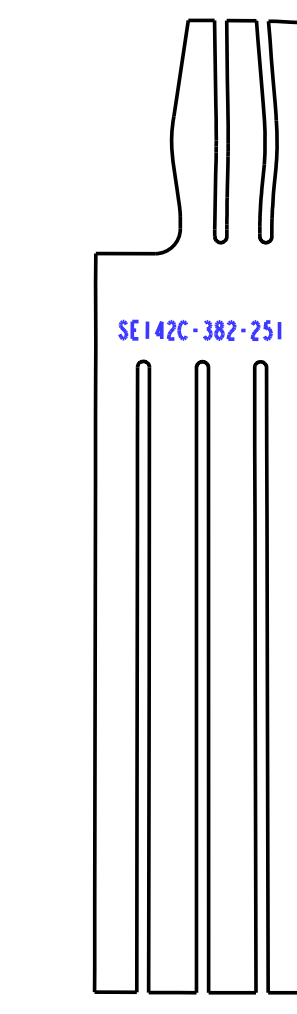

88

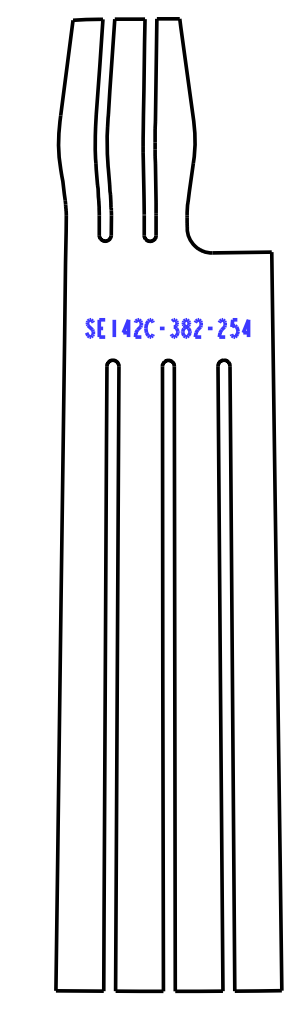
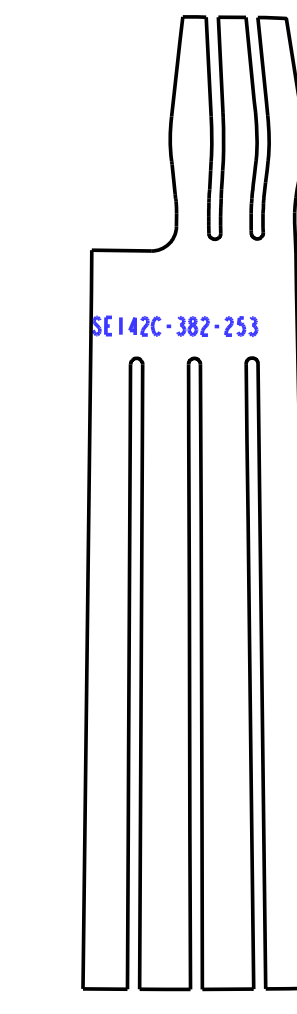

89

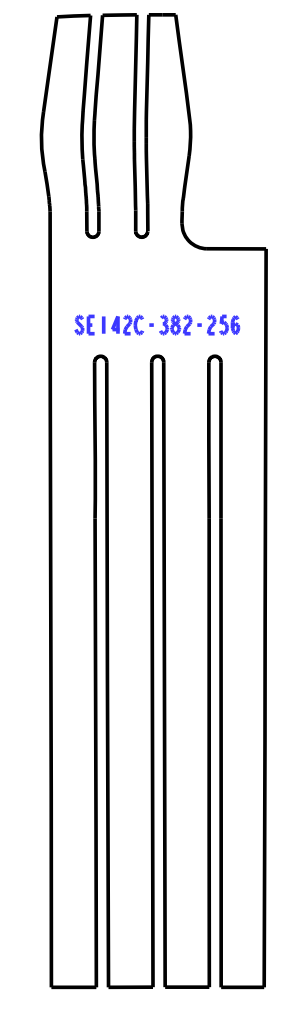
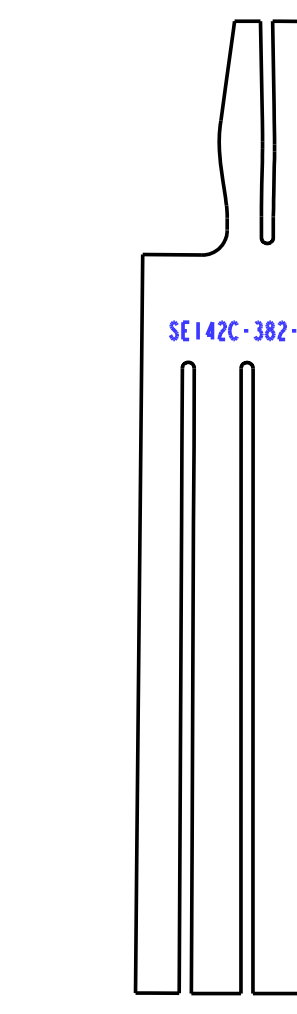

90

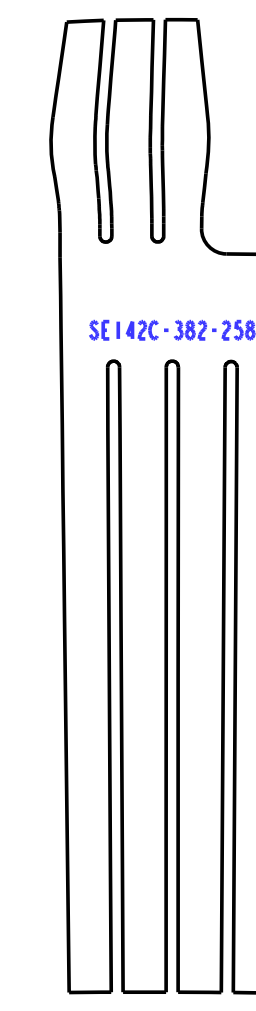
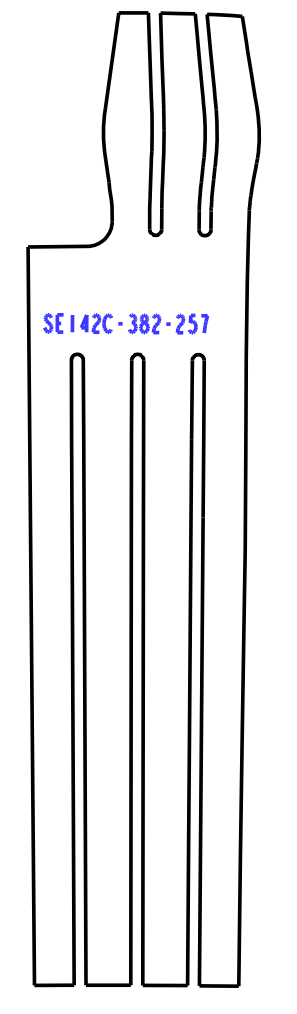

91

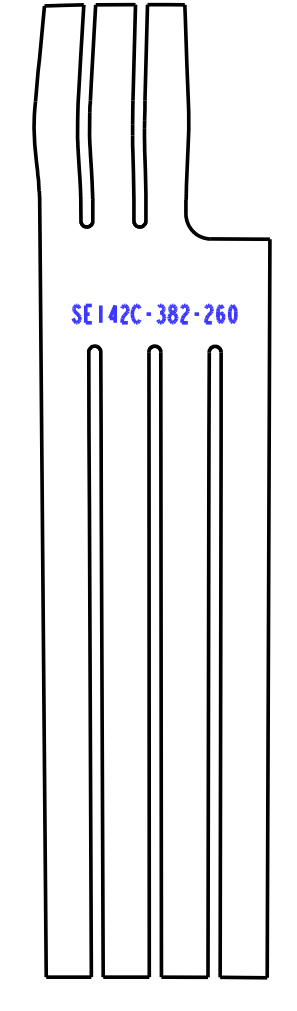
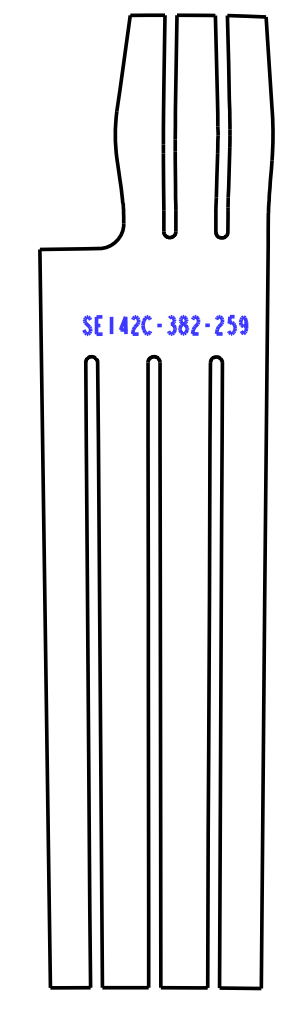

92

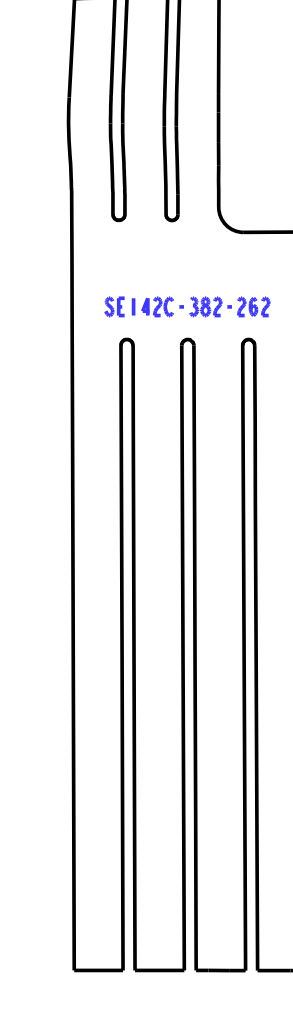
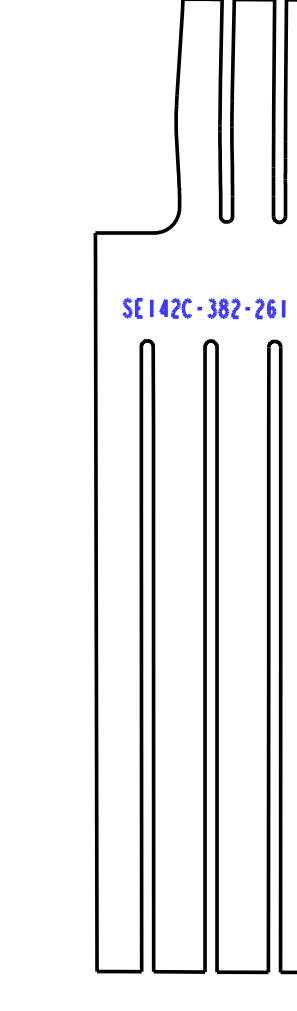

93

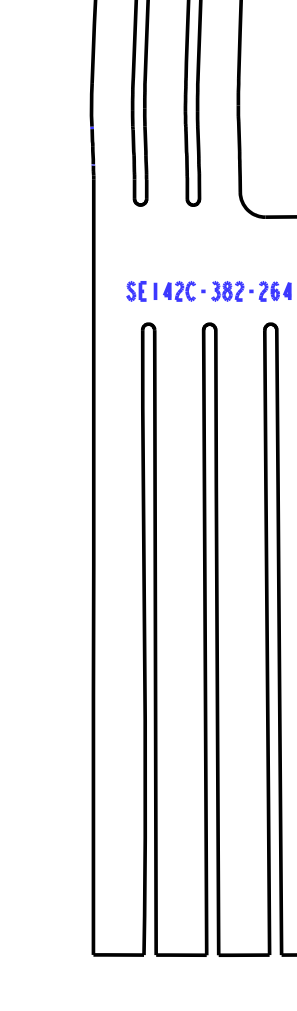
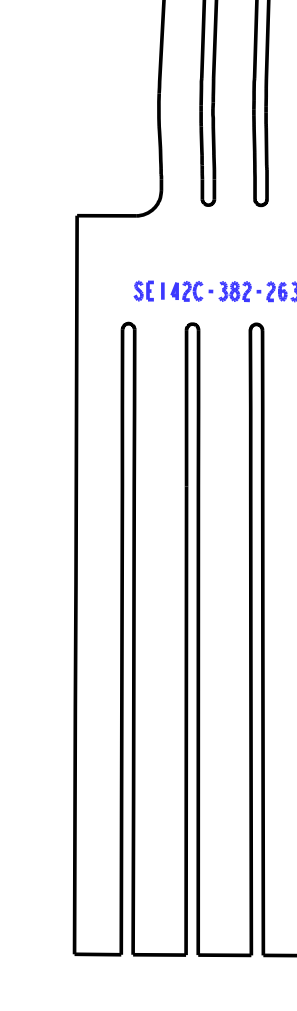

94

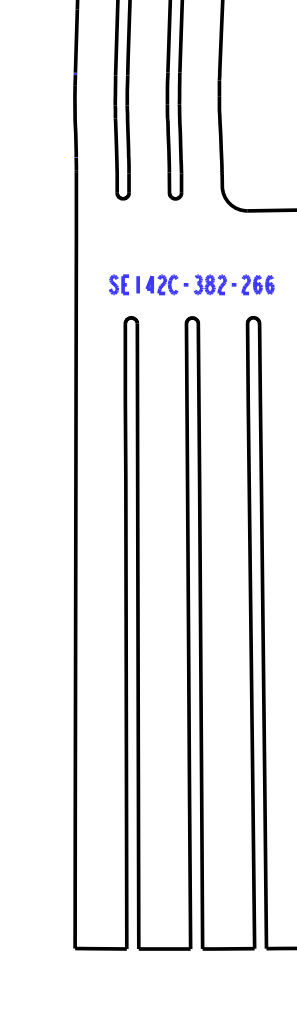
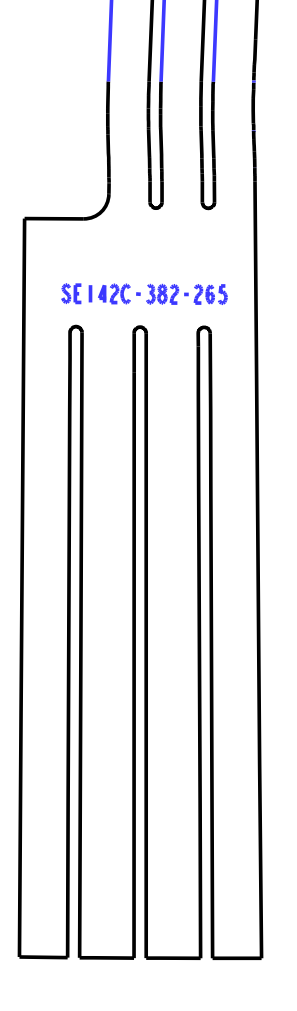

95

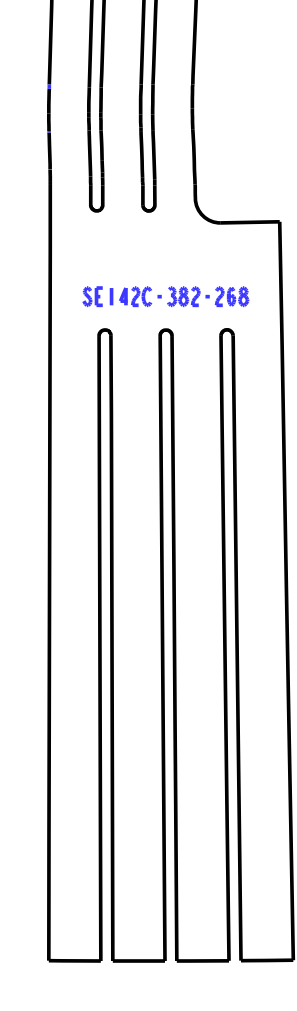
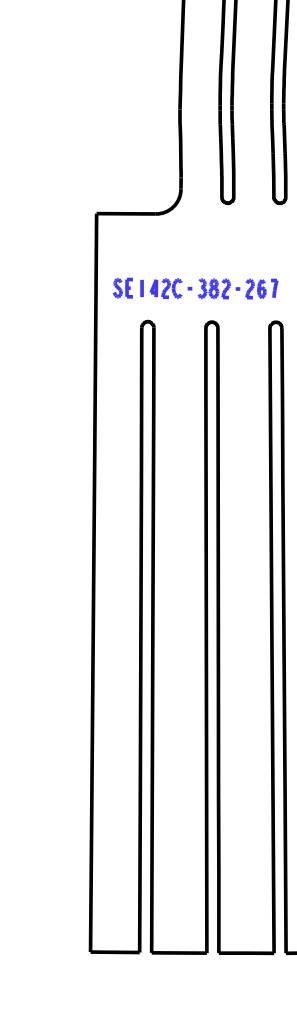

96

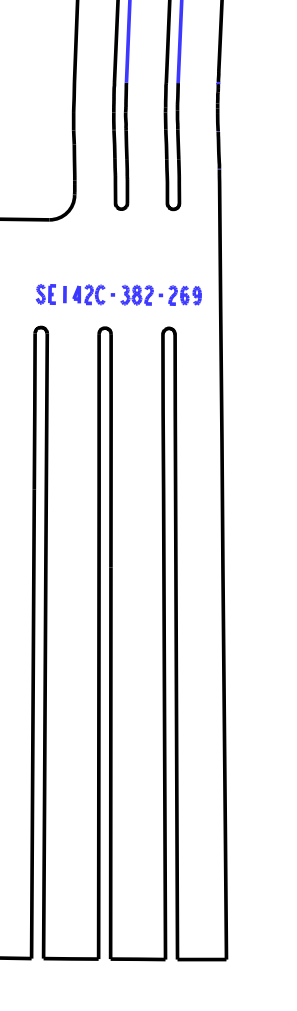

RELEASED FOR FABRICATION / INSTALLATION PPPL Drafting:

Oak Ridge National Laboratory managed for the DEPARTMENT OF ENERGY under U.S. GOVERNMENT contract DE-AC05-00OR22725 UT-BATTELLE, LLC, Oak Ridge, Tennessee							
<b>UT-BATTELLE</b>							
NATIONAL COMPACT STELLARATOR EXPERIMENT							
MODULAR COIL TYPE-C SIDE-A UPPER CLADDING FLAT PATTERN LAYOUT							
VERSION NO.	PLANT	BLDG	FL	SHT	OF	TYPE	CLASS
7	X-10	5700	3	5	5	S	U
RELEASE LEVEL		REV					
Fabrication		SE142C-382					
		0					

SE142C-382