

INSTANCE NAME	HOLE	S-DIM	PART NAME	INSTANCE NAME	HOLE	S-DIM	PART NAME
SE142C-382-FLAT.270		0.885417	SE142C-382-270	SE142C-382-FLAT.174		0.385417	SE142C-382-174
SE142C-382-FLAT.271	1	0.890625	SE142C-382-271	SE142C-382-FLAT.175	49	0.390625	SE142C-382-175
SE142C-382-FLAT.272		0.895833	SE142C-382-272	SE142C-382-FLAT.176		0.395833	SE142C-382-176
SE142C-382-FLAT.273	2	0.901042	SE142C-382-273	SE142C-382-FLAT.177	50	0.401042	SE142C-382-177
SE142C-382-FLAT.274		0.906250	SE142C-382-274	SE142C-382-FLAT.178		0.406250	SE142C-382-178
SE142C-382-FLAT.275	3	0.911458	SE142C-382-275	SE142C-382-FLAT.179	51	0.411458	SE142C-382-179
SE142C-382-FLAT.276		0.916667	SE142C-382-276	SE142C-382-FLAT.180		0.416667	SE142C-382-180
SE142C-382-FLAT.277	4	0.921875	SE142C-382-277	SE142C-382-FLAT.181	52	0.421875	SE142C-382-181
SE142C-382-FLAT.278		0.927083	SE142C-382-278	SE142C-382-FLAT.182		0.427083	SE142C-382-182
SE142C-382-FLAT.279	5	0.932292	SE142C-382-279	SE142C-382-FLAT.183	53	0.432292	SE142C-382-183
SE142C-382-FLAT.280		0.937500	SE142C-382-280	SE142C-382-FLAT.184		0.437500	SE142C-382-184
SE142C-382-FLAT.281	6	0.942708	SE142C-382-281	SE142C-382-FLAT.185	54	0.442708	SE142C-382-185
SE142C-382-FLAT.282		0.947917	SE142C-382-282	SE142C-382-FLAT.186		0.447917	SE142C-382-186
SE142C-382-FLAT.283	7	0.953125	SE142C-382-283	SE142C-382-FLAT.187	55	0.453125	SE142C-382-187
SE142C-382-FLAT.284		0.958333	SE142C-382-284	SE142C-382-FLAT.188		0.458333	SE142C-382-188
SE142C-382-FLAT.285	8	0.963542	SE142C-382-285	SE142C-382-FLAT.189	56	0.463542	SE142C-382-189
SE142C-382-FLAT.286		0.968750	SE142C-382-286	SE142C-382-FLAT.190		0.468750	SE142C-382-190
SE142C-382-FLAT.287	9	0.973958	SE142C-382-287	SE142C-382-FLAT.191	57	0.473958	SE142C-382-191
SE142C-382-FLAT.288		0.979167	SE142C-382-288	SE142C-382-FLAT.192		0.479167	SE142C-382-192
SE142C-382-FLAT.289	10	0.984375	SE142C-382-289	SE142C-382-FLAT.193	58	0.484375	SE142C-382-193
SE142C-382-FLAT.290-NEW		0.989583	SE142C-382-290	SE142C-382-FLAT.194		0.489583	SE142C-382-194
SE142C-382-FLAT.291	11	0.994792	SE142C-382-291	SE142C-382-FLAT.195-NEW	59	0.494792	SE142C-382-195
SE142C-382-FLAT.290		0.000000	SE142C-382-292	SE142C-382-FLAT.196-NEW		0.500000	SE142C-382-196
SE142C-382-FLAT.101	12	0.005208	SE142C-382-101	SE142C-382-FLAT.197	60	0.505208	SE142C-382-197
SE142C-382-FLAT.102		0.010417	SE142C-382-102	SE142C-382-FLAT.198-NEW		0.510417	SE142C-382-198
SE142C-382-FLAT.103-NEW	13	0.015625	SE142C-382-103	SE142C-382-FLAT.199-NEW	61	0.515625	SE142C-382-199
SE142C-382-FLAT.104-NEW		0.019341	SE142C-382-104	SE142C-382-FLAT.198		0.520833	SE142C-382-200
SE142C-382-FLAT.106-NEW		0.026426	SE142C-382-106	SE142C-382-FLAT.201	62	0.526042	SE142C-382-201
SE142C-382-FLAT.107-NEW		0.036000	SE142C-482-107	SE142C-382-FLAT.202		0.531250	SE142C-382-202
SE142C-382-FLAT.107-108	15	0.041000	SE142C-382-108	SE142C-382-FLAT.203	63	0.536458	SE142C-382-203
SE142C-382-FLAT.109		0.046875	SE142C-382-109	SE142C-382-FLAT.204		0.541667	SE142C-382-204
SE142C-382-FLAT.110	16	0.052083	SE142C-382-110	SE142C-382-FLAT.205	64	0.546875	SE142C-382-205
SE142C-382-FLAT.111		0.057292	SE142C-382-111	SE142C-382-FLAT.206		0.552083	SE142C-382-206
SE142C-382-FLAT.112	17	0.062500	SE142C-382-112	SE142C-382-FLAT.207	65	0.557292	SE142C-382-207
SE142C-382-FLAT.113		0.067708	SE142C-382-113	SE142C-382-FLAT.208		0.562500	SE142C-382-208
SE142C-382-FLAT.114	18	0.072917	SE142C-382-114	SE142C-382-FLAT.209	66	0.567708	SE142C-382-209
SE142C-382-FLAT.115		0.078125	SE142C-382-115	SE142C-382-FLAT.210		0.572917	SE142C-382-210
SE142C-382-FLAT.116	19	0.083333	SE142C-382-116	SE142C-382-FLAT.211	67	0.578125	SE142C-382-211
SE142C-382-FLAT.117		0.088542	SE142C-382-117	SE142C-382-FLAT.212		0.583334	SE142C-382-212
SE142C-382-FLAT.118	20	0.093750	SE142C-382-118	SE142C-382-FLAT.213	68	0.588542	SE142C-382-213
SE142C-382-FLAT.119		0.098958	SE142C-382-119	SE142C-382-FLAT.214		0.593750	SE142C-382-214
SE142C-382-FLAT.120	21	0.104167	SE142C-382-120	SE142C-382-FLAT.215	69	0.598959	SE142C-382-215
SE142C-382-FLAT.121		0.109375	SE142C-382-121	SE142C-382-FLAT.216		0.604167	SE142C-382-216
SE142C-382-FLAT.122	22	0.114583	SE142C-382-122	SE142C-382-FLAT.217	70	0.609375	SE142C-382-217
SE142C-382-FLAT.123		0.119792	SE142C-382-123	SE142C-382-FLAT.218		0.614584	SE142C-382-218
SE142C-382-FLAT.124	23	0.125000	SE142C-382-124	SE142C-382-FLAT.219	71	0.619792	SE142C-382-219
SE142C-382-FLAT.125		0.130208	SE142C-382-125	SE142C-382-FLAT.220		0.625000	SE142C-382-220
SE142C-382-FLAT.126	24	0.135417	SE142C-382-126	SE142C-382-FLAT.221	72	0.630209	SE142C-382-221
SE142C-382-FLAT.127		0.140625	SE142C-382-127	SE142C-382-FLAT.222		0.635417	SE142C-382-222
SE142C-382-FLAT.128	25	0.145833	SE142C-382-128	SE142C-382-FLAT.223	73	0.640625	SE142C-382-223
SE142C-382-FLAT.129		0.151042	SE142C-382-129	SE142C-382-FLAT.224		0.645834	SE142C-382-224
SE142C-382-FLAT.130	26	0.156250	SE142C-382-130	SE142C-382-FLAT.225	74	0.651042	SE142C-382-225
SE142C-382-FLAT.131		0.161458	SE142C-382-131	SE142C-382-FLAT.226		0.656250	SE142C-382-226
SE142C-382-FLAT.132	27	0.166667	SE142C-382-132	SE142C-382-FLAT.227	75	0.661458	SE142C-382-227
SE142C-382-FLAT.133		0.171875	SE142C-382-133	SE142C-382-FLAT.228		0.666667	SE142C-382-228
SE142C-382-FLAT.134	28	0.177083	SE142C-382-134	SE142C-382-FLAT.229	76	0.671875	SE142C-382-229
SE142C-382-FLAT.135		0.182292	SE142C-382-135	SE142C-382-FLAT.230		0.677083	SE142C-382-230
SE142C-382-FLAT.136	29	0.187500	SE142C-382-136	SE142C-382-FLAT.231	77	0.682292	SE142C-382-231
SE142C-382-FLAT.137		0.192708	SE142C-382-137	SE142C-382-FLAT.232		0.687500	SE142C-382-232
SE142C-382-FLAT.138	30	0.197917	SE142C-382-138	SE142C-382-FLAT.233	78	0.692708	SE142C-382-233
SE142C-382-FLAT.139		0.203125	SE142C-382-139	SE142C-382-FLAT.234		0.697917	SE142C-382-234
SE142C-382-FLAT.140	31	0.208333	SE142C-382-140	SE142C-382-FLAT.235	79	0.703125	SE142C-382-235
SE142C-382-FLAT.141		0.213542	SE142C-382-141	SE142C-382-FLAT.236		0.708333	SE142C-382-236
SE142C-382-FLAT.142	32	0.218750	SE142C-382-142	SE142C-382-FLAT.237	80	0.713542	SE142C-382-237
SE142C-382-FLAT.143		0.223958	SE142C-382-143	SE142C-382-FLAT.238		0.718750	SE142C-382-238
SE142C-382-FLAT.144	33	0.229167	SE142C-382-144	SE142C-382-FLAT.239	81	0.723958	SE142C-382-239
SE142C-382-FLAT.145		0.234375	SE142C-382-145	SE142C-382-FLAT.240		0.729167	SE142C-382-240
SE142C-382-FLAT.146	34	0.239583	SE142C-382-146	SE142C-382-FLAT.241	82	0.734375	SE142C-382-241
SE142C-382-FLAT.147		0.244792	SE142C-382-147	SE142C-382-FLAT.242		0.739583	SE142C-382-242
SE142C-382-FLAT.148	35	0.250000	SE142C-382-148	SE142C-382-FLAT.243	83	0.744792	SE142C-382-243
SE142C-382-FLAT.149		0.255208	SE142C-382-149	SE142C-382-FLAT.244		0.750000	SE142C-382-244
SE142C-382-FLAT.150	36	0.260417	SE142C-382-150	SE142C-382-FLAT.245	84	0.755208	SE142C-382-245
SE142C-382-FLAT.151		0.265625	SE142C-382-151	SE142C-382-FLAT.246		0.760417	SE142C-382-246
SE142C-382-FLAT.152	37	0.270833	SE142C-382-152	SE142C-382-FLAT.247	85	0.765625	SE142C-382-247
SE142C-382-FLAT.153		0.276042	SE142C-382-153	SE142C-382-FLAT.248		0.770833	SE142C-382-248
SE142C-382-FLAT.154	38	0.281250	SE142C-382-154	SE142C-382-FLAT.249	86	0.776042	SE142C-382-249
SE142C-382-FLAT.155		0.286458	SE142C-382-155	SE142C-382-FLAT.250		0.781250	SE142C-382-250
SE142C-382-FLAT.156	39	0.291667	SE142C-382-156	SE142C-382-FLAT.251	87	0.786458	SE142C-382-251
SE142C-382-FLAT.157		0.296875	SE142C-382-157	SE142C-382-FLAT.252		0.791667	SE142C-382-252
SE142C-382-FLAT.158	40	0.302083	SE142C-382-158	SE142C-382-FLAT.253	88	0.796875	SE142C-382-253
SE142C-382-FLAT.159		0.307292	SE142C-382-159	SE142C-382-FLAT.254		0.802083	SE142C-382-254
SE142C-382-FLAT.160	41	0.312500	SE142C-382-160	SE142C-382-FLAT.255	89	0.807292	SE142C-382-255
SE142C-382-FLAT.161		0.317708	SE142C-382-161	SE142C-382-FLAT.256		0.812500	SE142C-382-256
SE142C-382-FLAT.162	42	0.322917	SE142C-382-162	SE142C-382-FLAT.257	90	0.817708	SE142C-382-257
SE142C-382-FLAT.163		0.328125	SE142C-382-163	SE142C-382-FLAT.258		0.822917	SE142C-382-258
SE142C-382-FLAT.164	43	0.333333	SE142C-382-164	SE142C-382-FLAT.259	91	0.828125	SE142C-382-259
SE142C-382-FLAT.165		0.338542	SE142C-382-165	SE142C-382-FLAT.260		0.833333	SE142C-382-260
SE142C-382-FLAT.166	44	0.343750	SE142C-382-166	SE142C-382-FLAT.261	92	0.838542	SE142C-382-261
SE142C-382-FLAT.167		0.348958	SE142C-382-167	SE142C-382-FLAT.262		0.843750	SE142C-382-262
SE142C-382-FLAT.168	45	0.354167	SE142C-382-168	SE142C-382-FLAT.263	93	0.848958	SE142C-382-263
SE142C-382-FLAT.169		0.359375	SE142C-382-169	SE142C-382-FLAT.264		0.854167	SE142C-382-264
SE142C-382-FLAT.170	46	0.364583	SE142C-382-170	SE142C-382-FLAT.265	94	0.859375	SE142C-382-265
SE142C-382-FLAT.171		0.369792	SE142C-382-171	SE142C-382-FLAT.266		0.864583	SE142C-382-266
SE142C-382-FLAT.172	47	0.375000	SE142C-382-172	SE142C-382-FLAT.267	95	0.869792	SE142C-382-267
SE142C-382-FLAT.173		0.380208	SE142C-382-173	SE142C-382-FLAT.268		0.875000	SE142C-382-268
	48			SE142C-382-FLAT.269	96	0.880208	SE142C-382-269

- NOTES:
- DRAWING PREPARED IN ACCORDANCE WITH ASME Y14.8M-1996.
 - INTERPRET DIMENSIONS AND TOLERANCES PER ANSI Y14.5M-1994.
 - DIMENSIONS ARE IN INCHES.
 - DRAWING DEPICTS FLAT PATTERN OF FORMED PARTS DEFINED BY PRO/ENGINEER FILES SE142C-382-XXX_FORM.PRT.
 - PROFILE TOLERANCE OF FLAT PATTERN IS +/- .010-IN
 - REMOVE ALL BURRS AND SHARP EDGES.
 - IDENTIFY PARTS BY ETCHING OR PERMANENT MARKER.
 - INDICATED PARTS TO BE NEMA GRADE G1ICR MATERIAL.

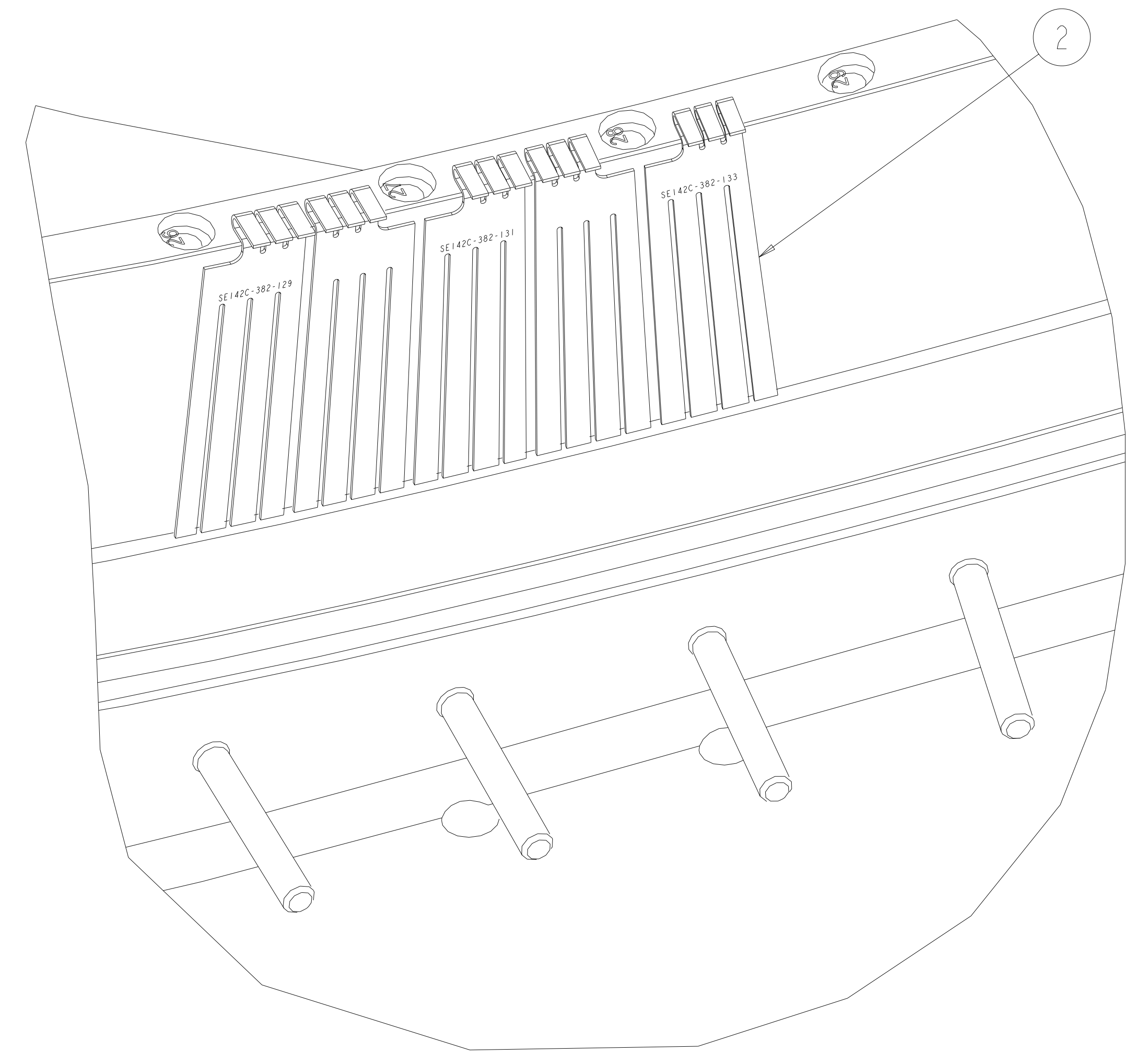

ISOMETRIC VIEW

next assy	AR	X	CAGE CODE	PART OR IDENTIFYING NO	NOMENCLATURE OR DESCRIPTION	MATERIAL / SPECIFICATION	FIND NO
					CLADDING PARTS	1 COPPER, ANNEALED UNS C10100, C10200, C11000 ETP OR NEMA GRADE G1ICR WHERE NOTED	2
						TYPE-C SIDE-A UPPER CLADDING ASM	1
						MATERIAL / SPECIFICATION	
					← NEXT ASSEMBLY	PARTS LIST	

8

7

6

5

4

3

2

1

NEXT ASS'Y:

FINAL ASS'Y:

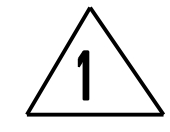

THESE PARTS NEMA GRADE GIICR MATERIAL

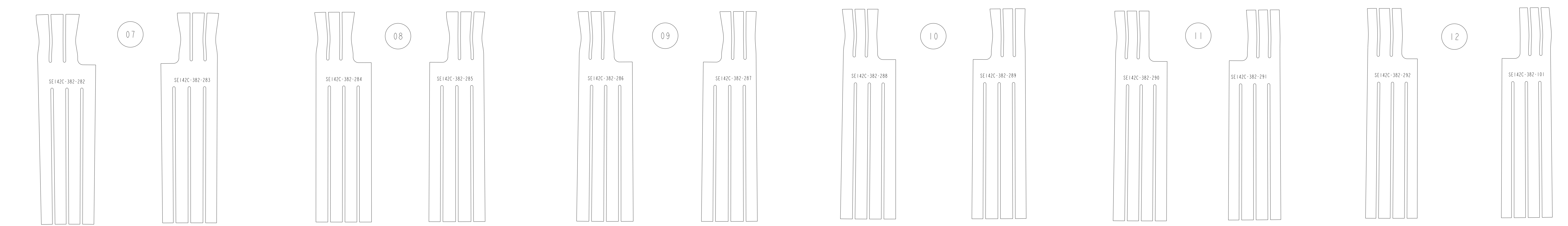
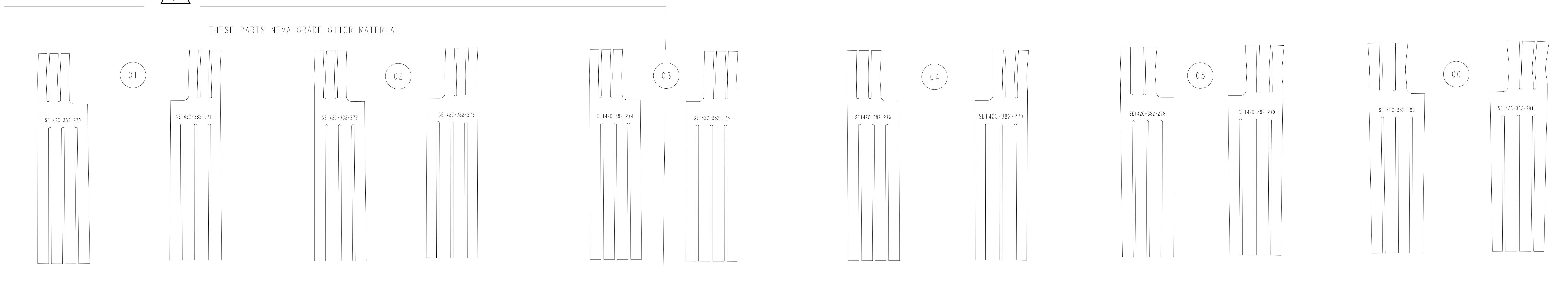

POLOIDAL BREAK

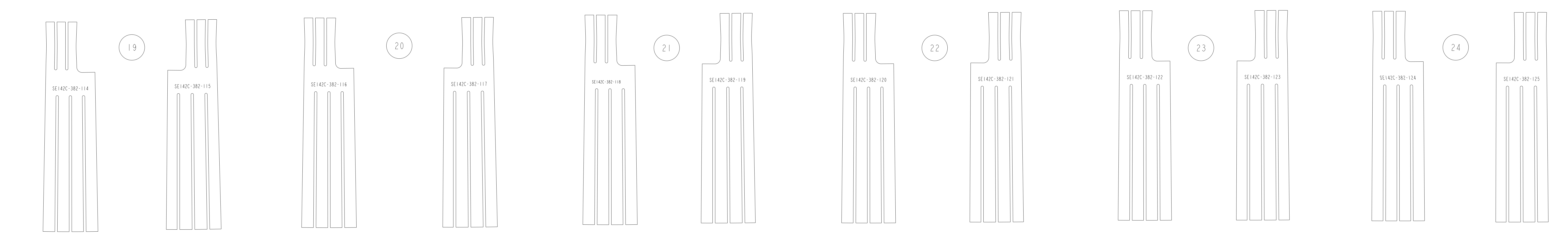
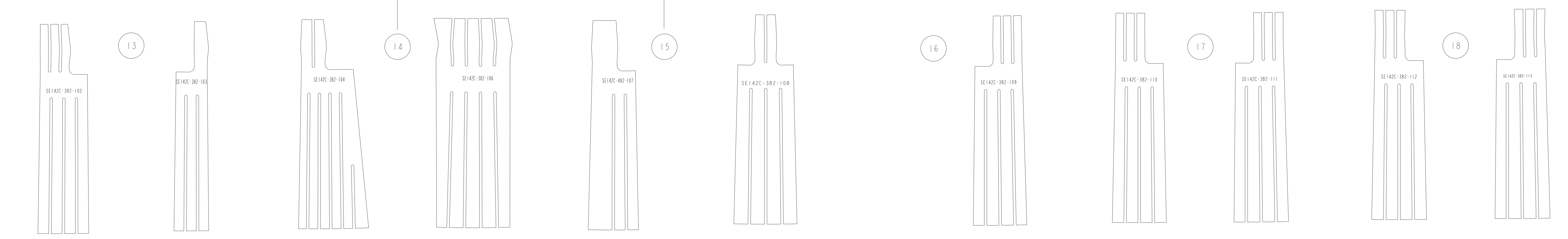

Oak Ridge National Laboratory managed for the DEPARTMENT OF ENERGY under U.S. GOVERNMENT CONTRACT DE-AC05-00OR22725 UT-BATTELLE, LLC, Oak Ridge, Tennessee PROJECT NAME							
UT-BATTELLE NATIONAL COMPACT STELLARATOR EXPERIMENT							
MODULAR COIL TYPE-C SIDE-A UPPER CLADDING FLAT PATTERN LAYOUT							
VERSION NO.	PLANT	BLDG	FL	SHT	OF	TYPE	CLASS
4	X-10	5700	3	2	5	S	U
RELEASE LEVEL		SEI42C-382		REV			
WIP				I			

8

7

6

5

4

3

2

1

SEI42C-382

A

8

7

6

5

4

3

2

1

NEXT ASS'Y:

FINAL ASS'Y:

H

H

G

G

F

F

E

E

D

D

C

C

B

B

A

A

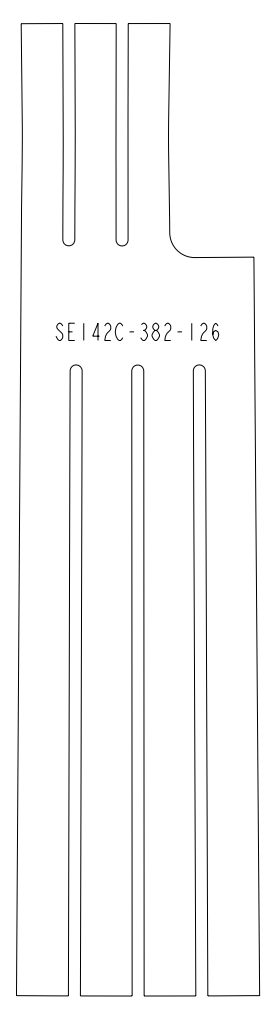

25

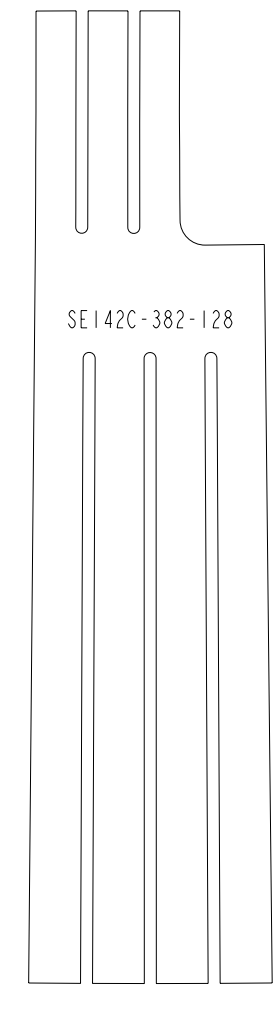
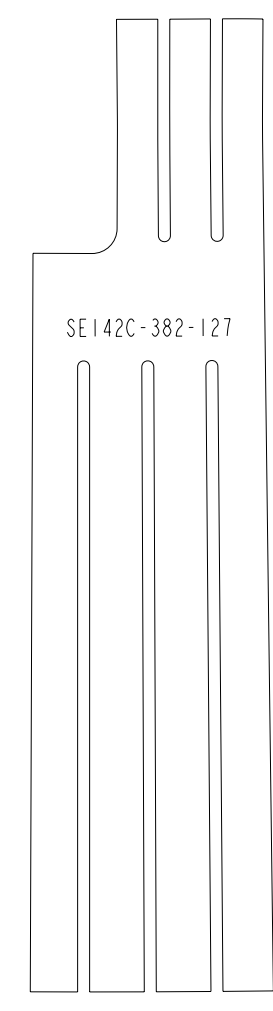

26

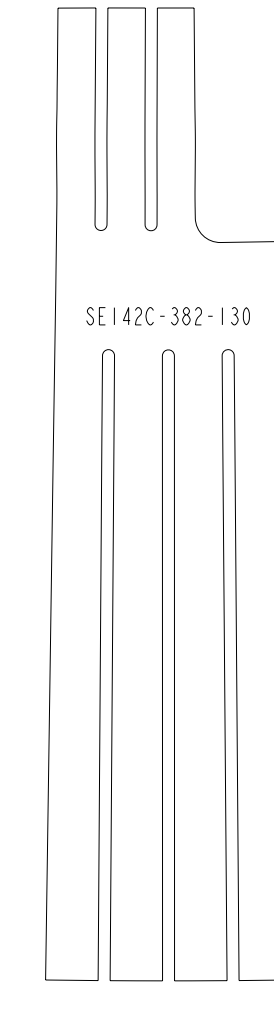
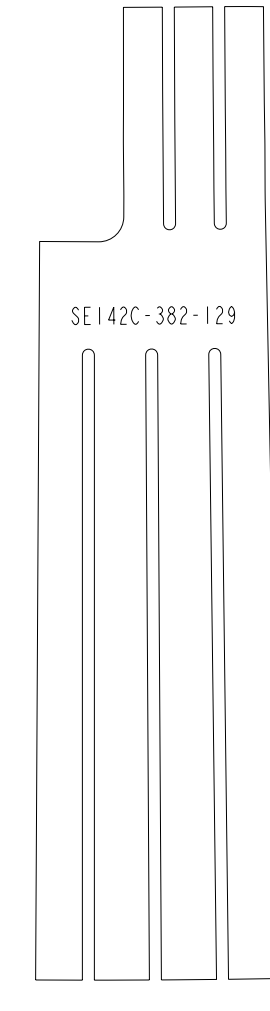

27

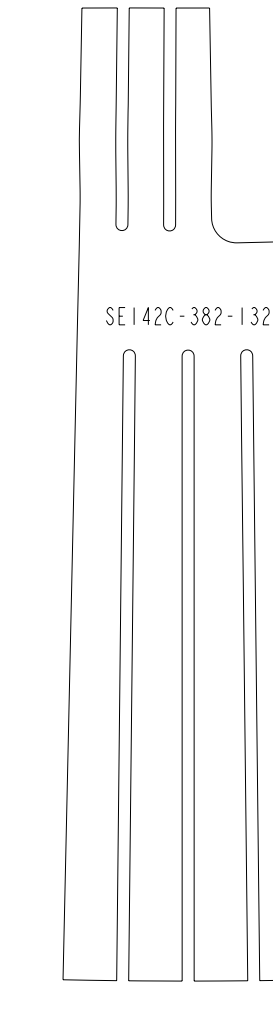
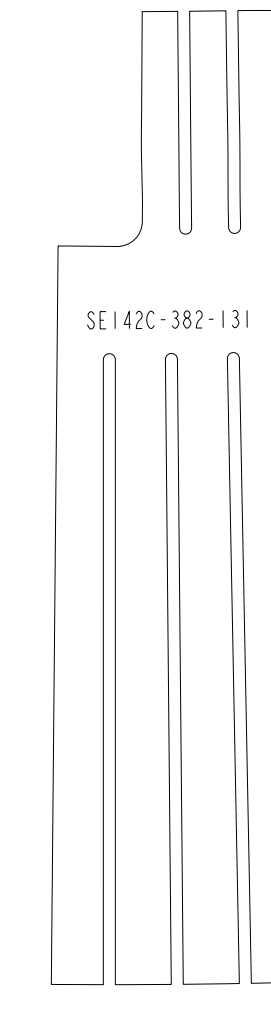

28

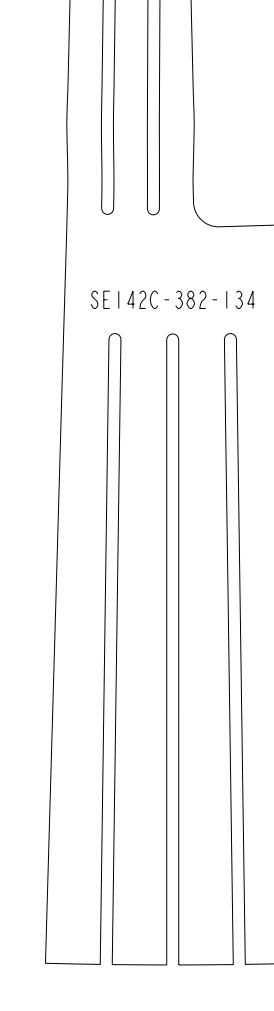
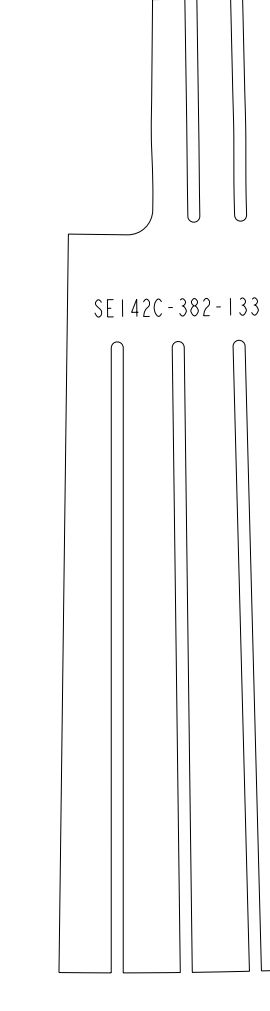

29

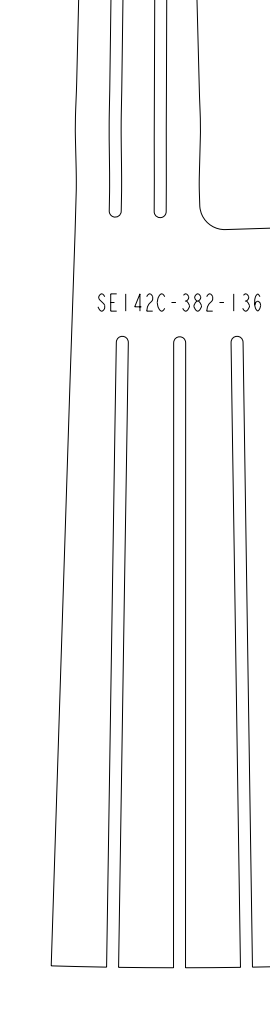
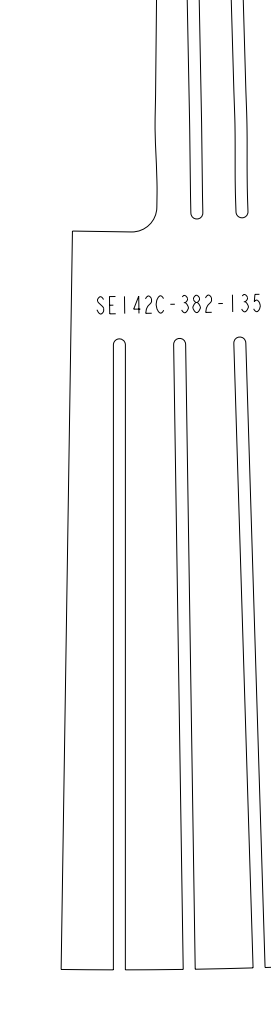

30

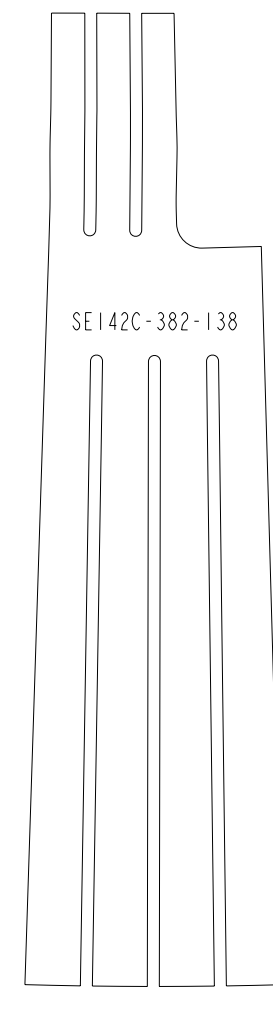
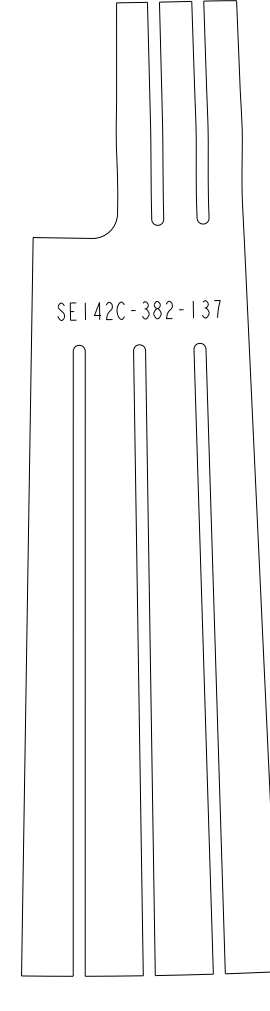

31

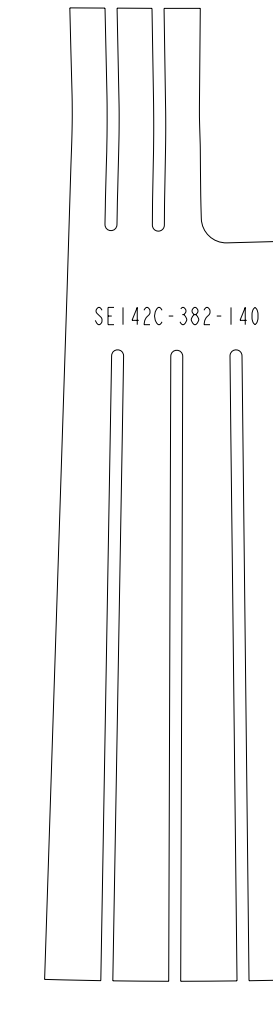
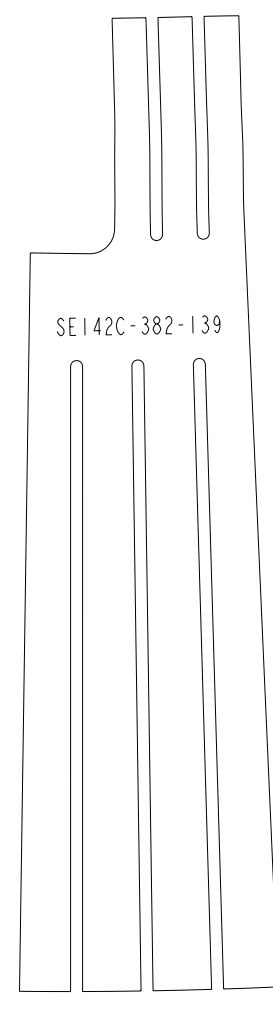

32

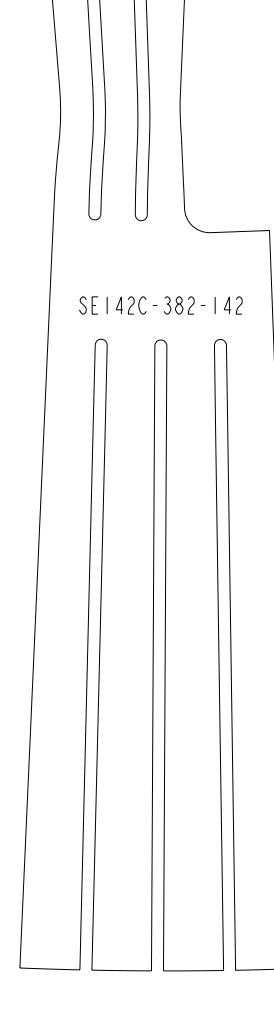
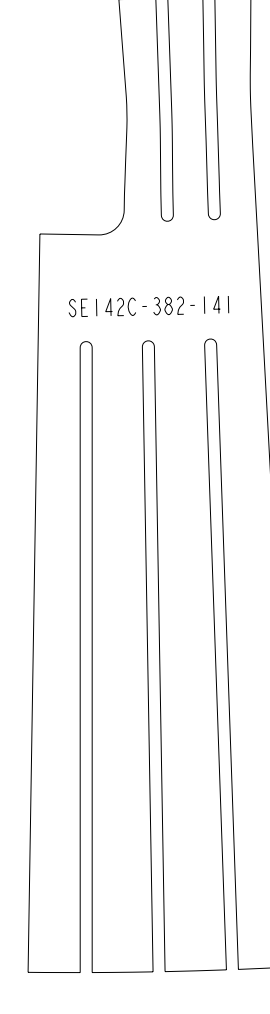

33

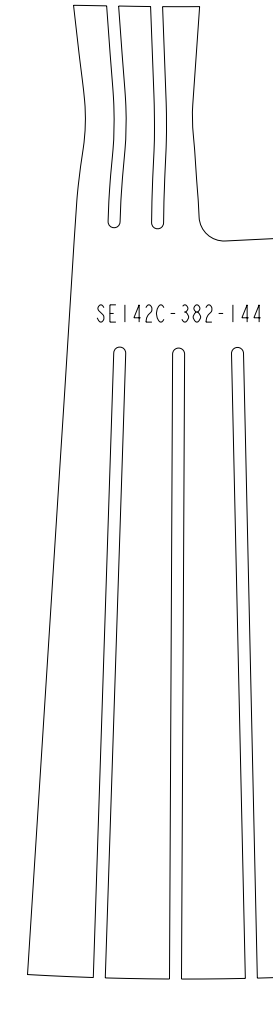
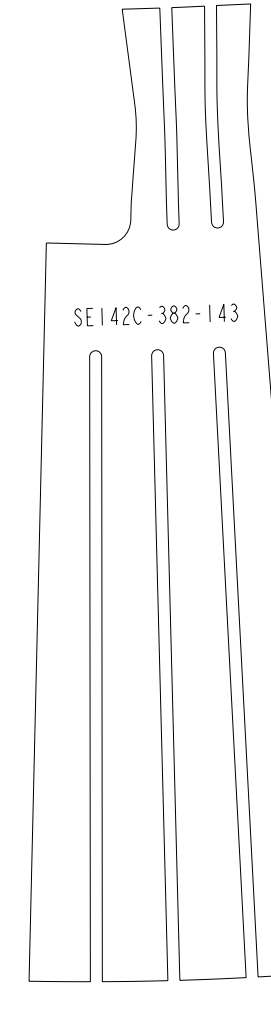

34

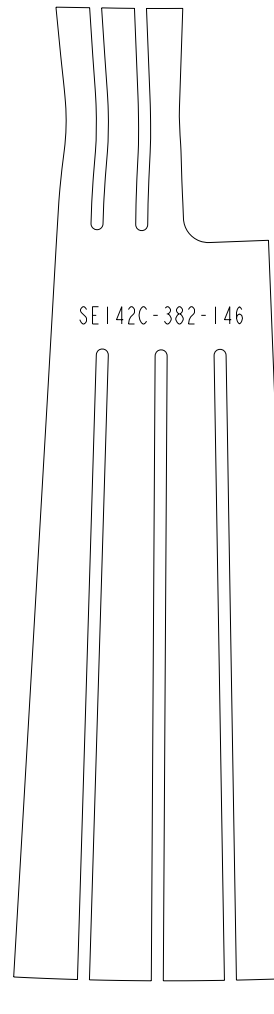
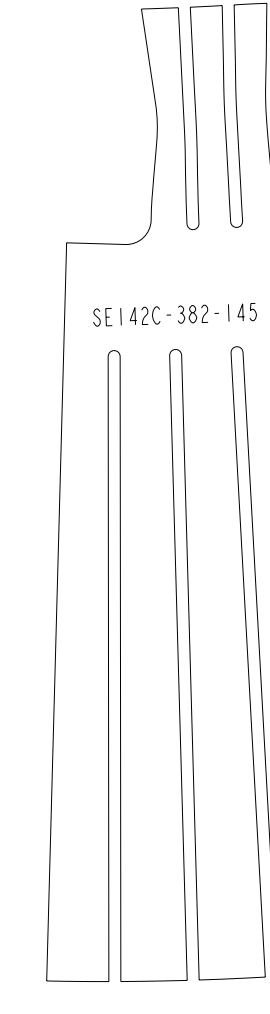

35

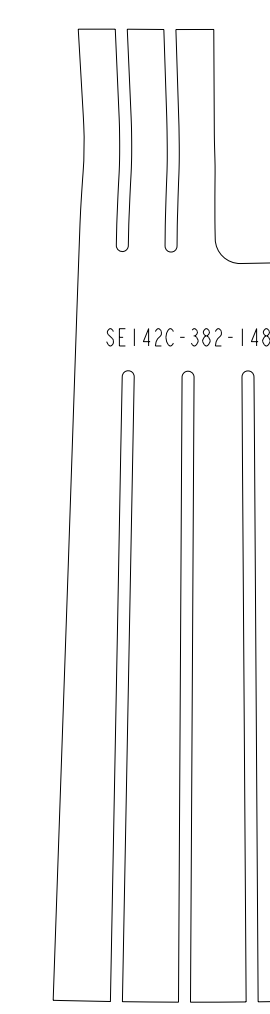
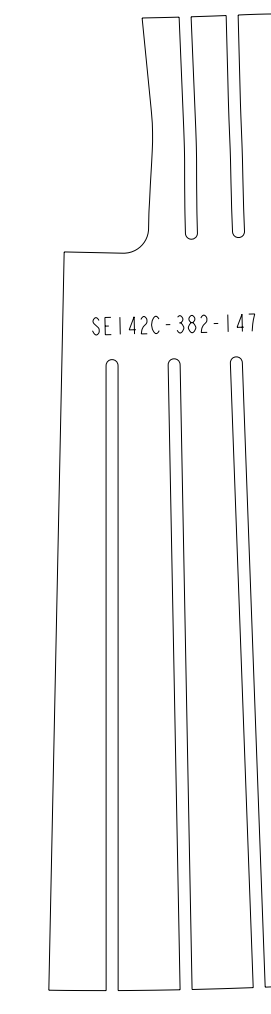

36

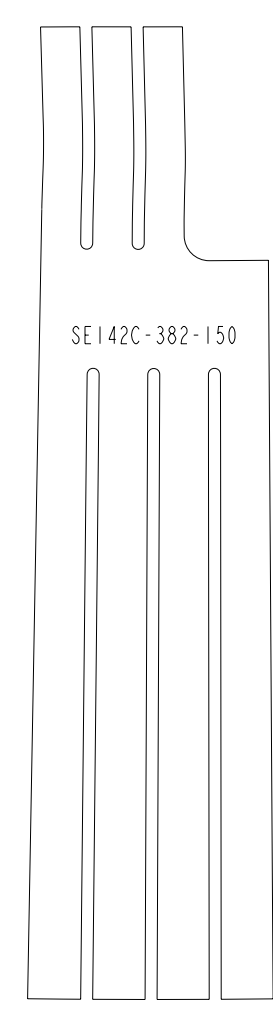
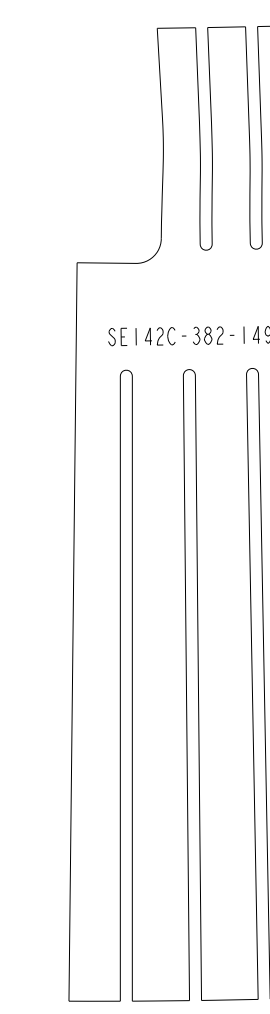

37

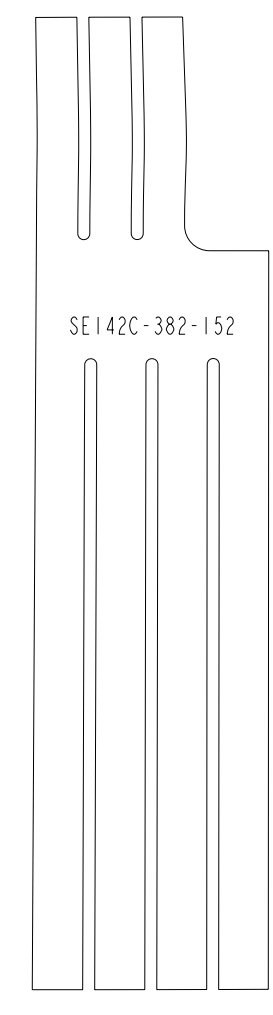
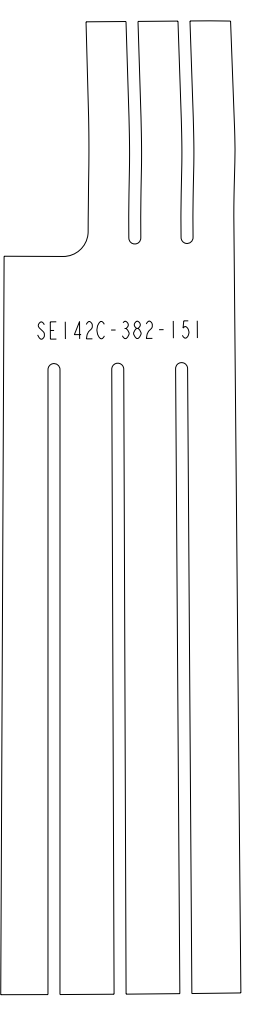

38

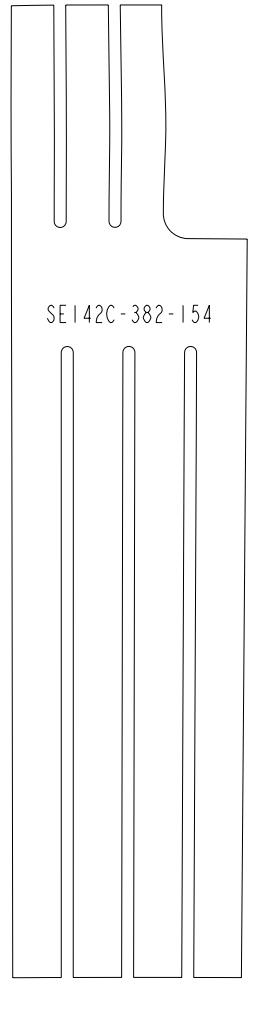
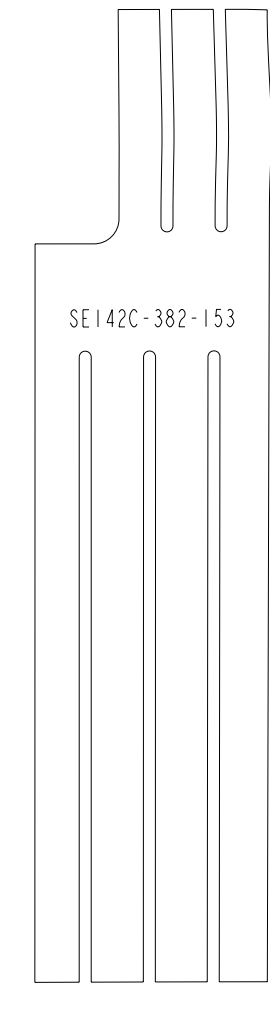

39

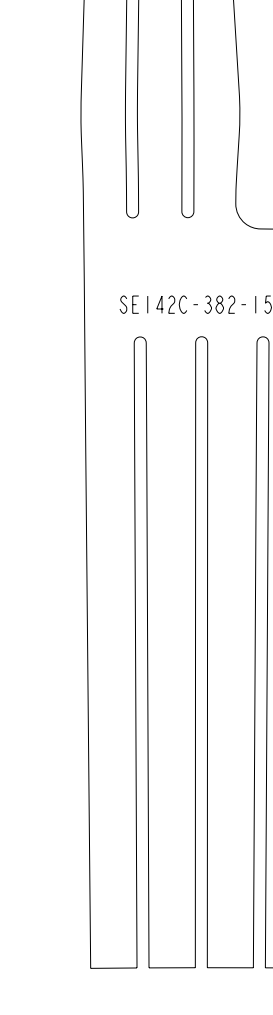
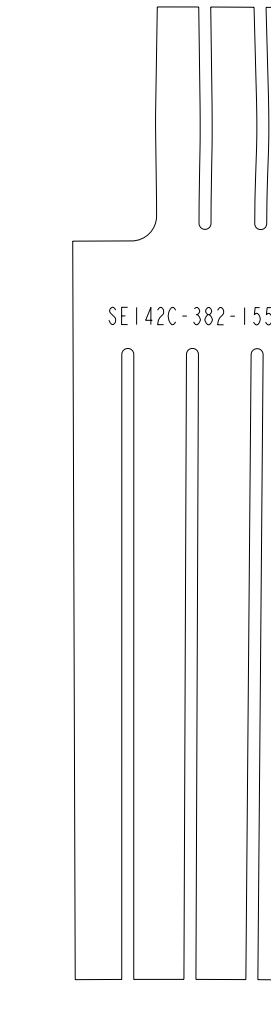

40

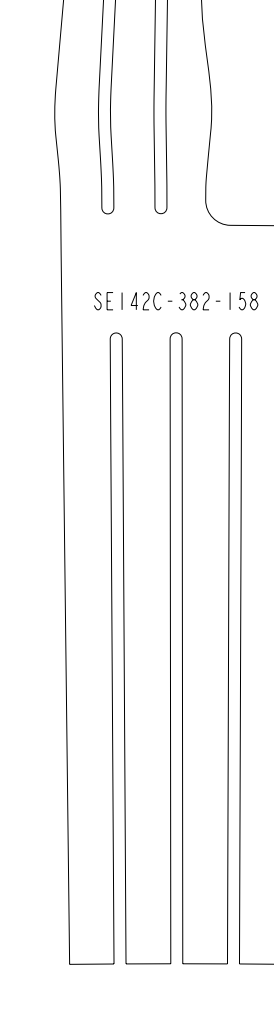
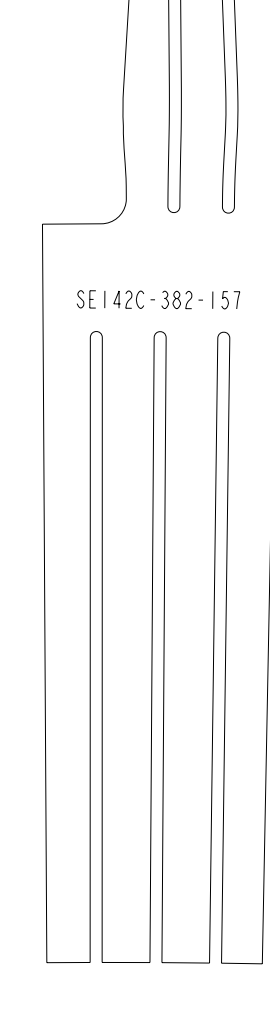

41

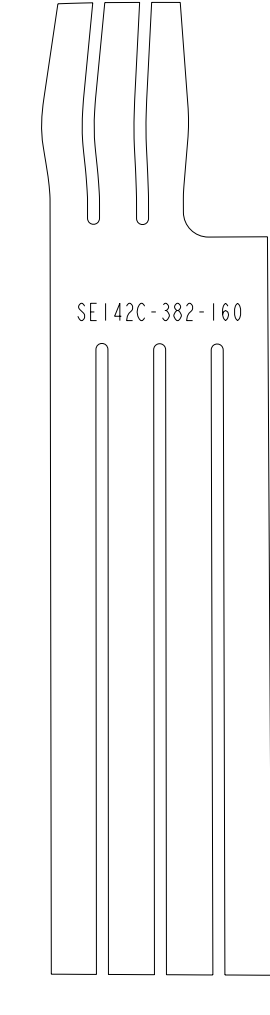
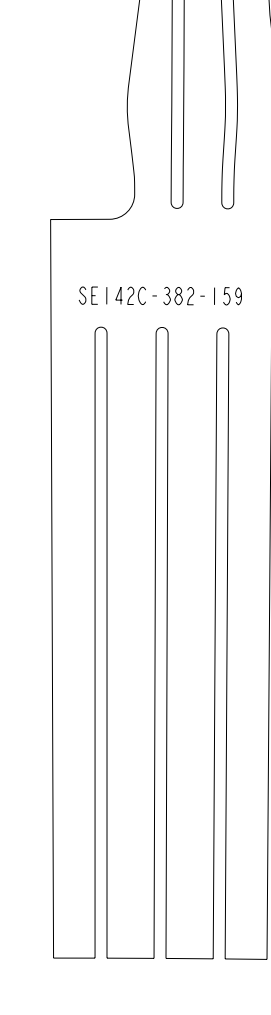

42

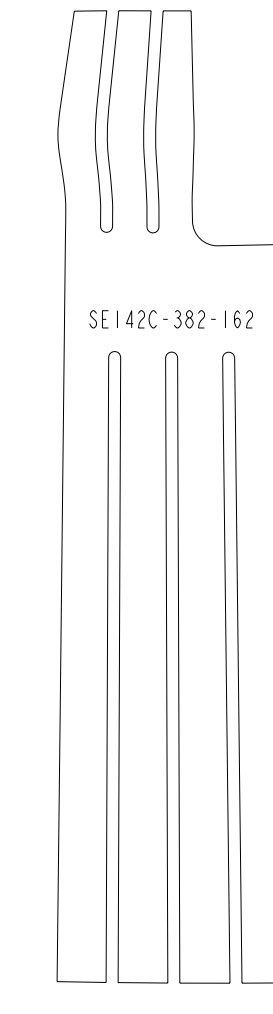
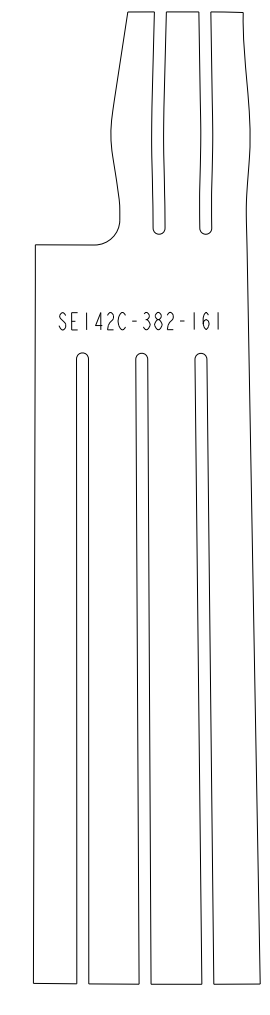

43

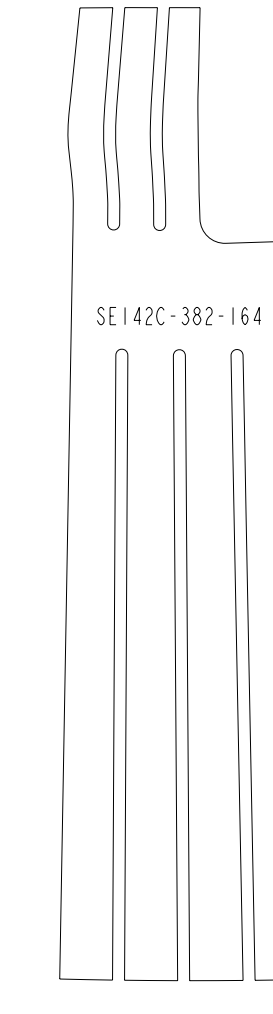
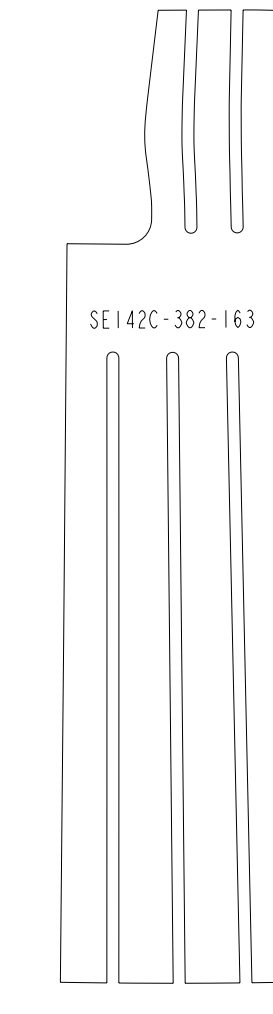

44

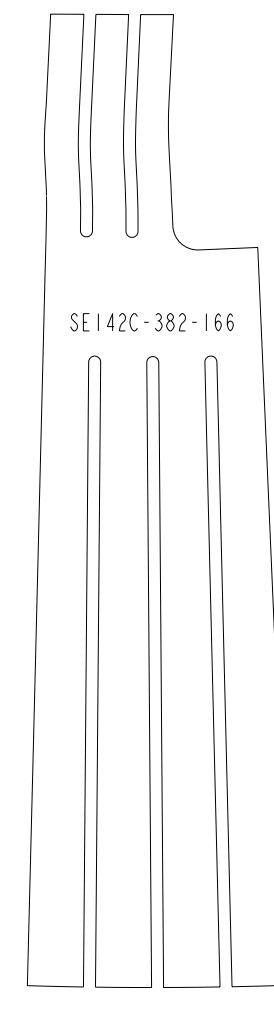
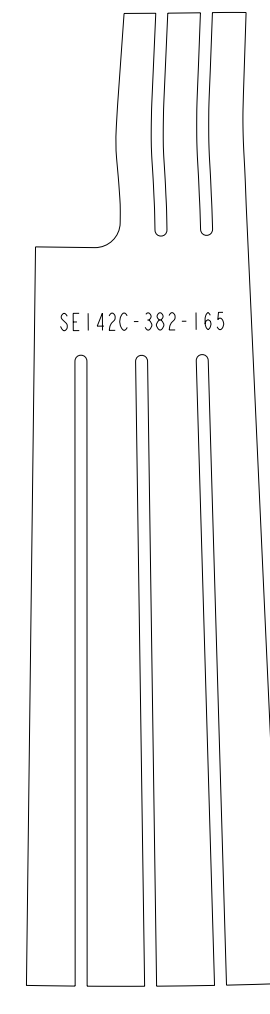

45

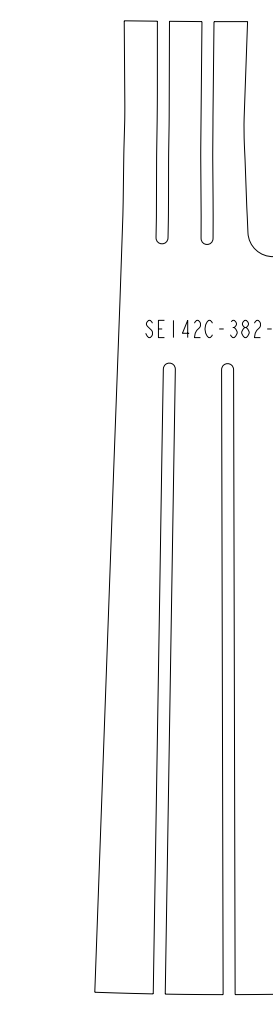
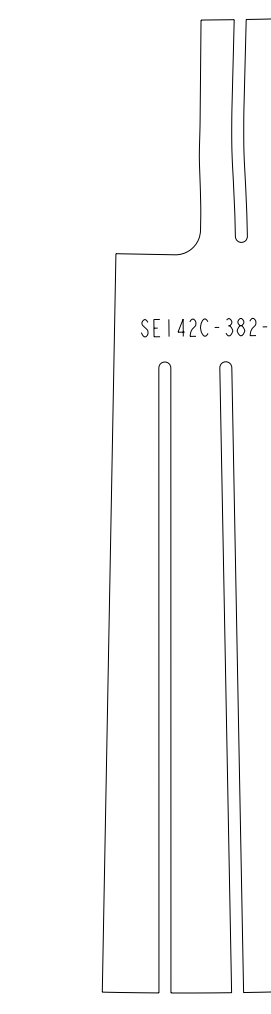

46

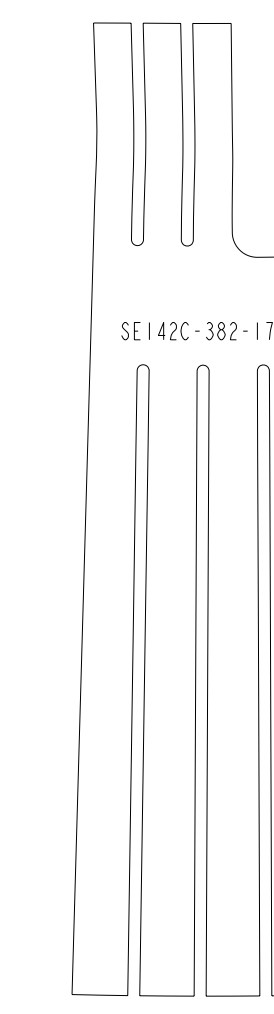
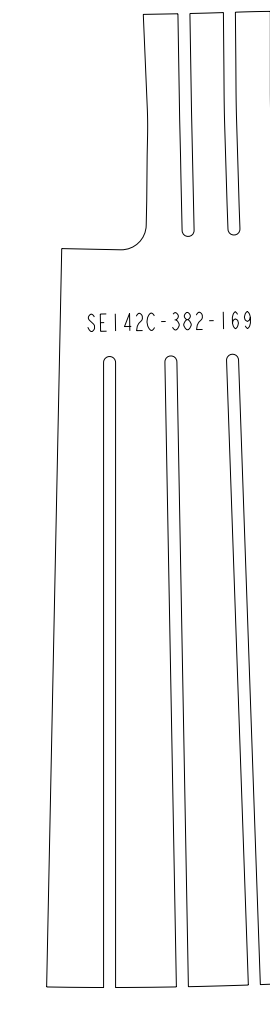

47

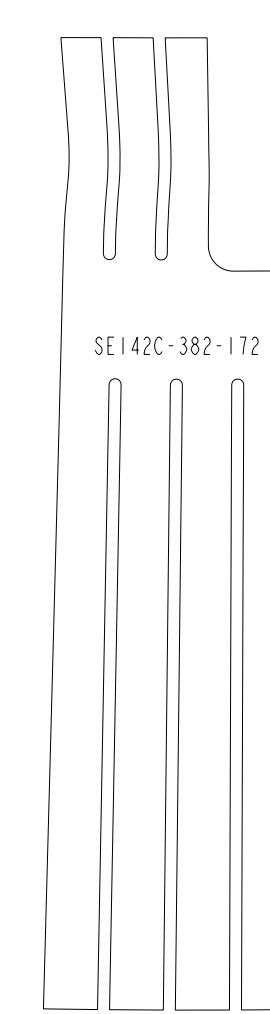
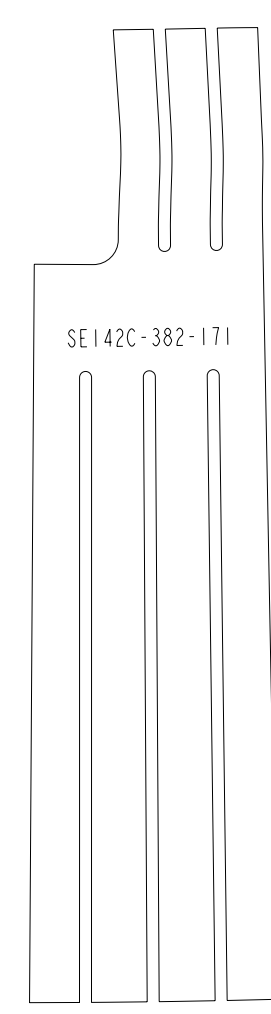

48

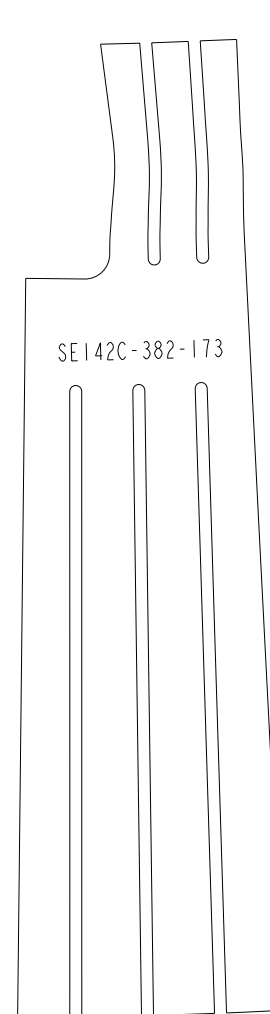

8

7

6

5

4

3

2

1

Oak Ridge National Laboratory
 managed for the DEPARTMENT OF ENERGY under
 U.S. GOVERNMENT CONTRACT DE-AC05-00OR22725
 UT-BATTELLE, LLC, Oak Ridge, Tennessee
 PROJECT NAME

UT-BATTELLE

NATIONAL COMPACT STELLARATOR EXPERIMENT

MODULAR COIL TYPE-C
SIDE-A UPPER CLADDING
FLAT PATTERN LAYOUT

VERSION NO. 4	PLANT X-10	BLDG 5700	FL 3	SHT OF 3	TYPE 5	CLASS S	U U
RELEASE LEVEL WIP		SE142C-382		REV I			

208-22131

8

7

6

5

4

3

2

1

NEXT ASS'Y:

FINAL ASS'Y:

H

H

G

G

F

F

E

E

D

D

C

C

B

B

A

A

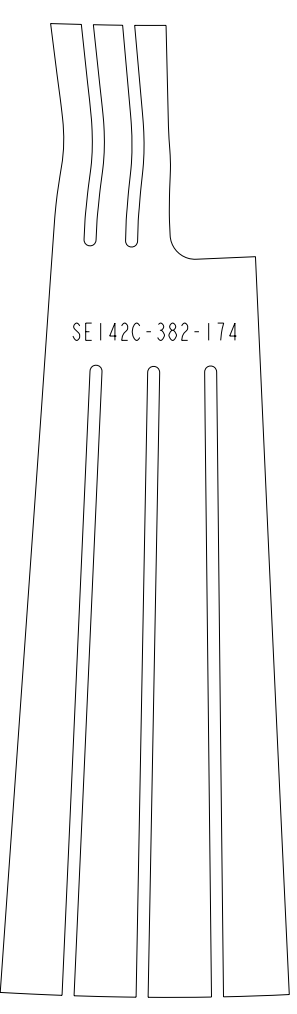

49

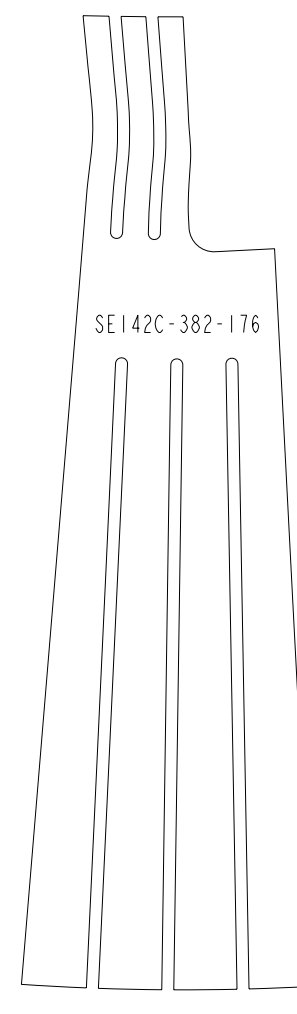
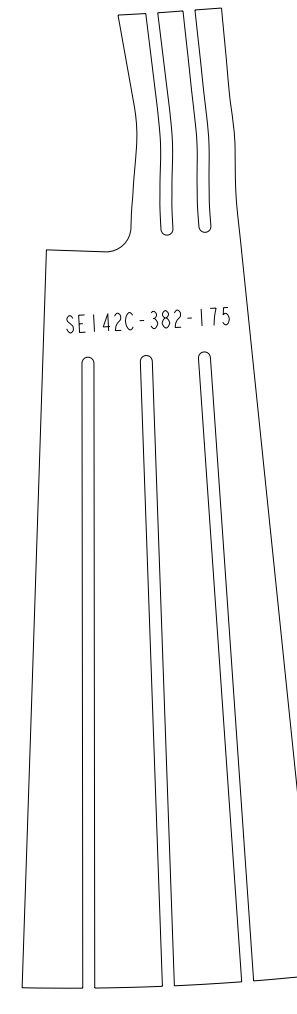

50

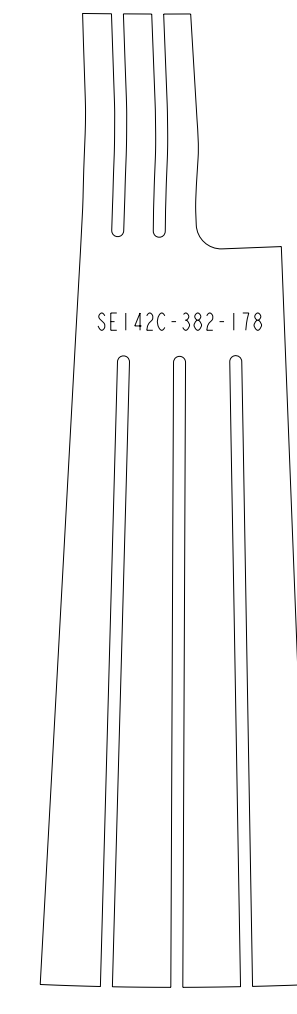
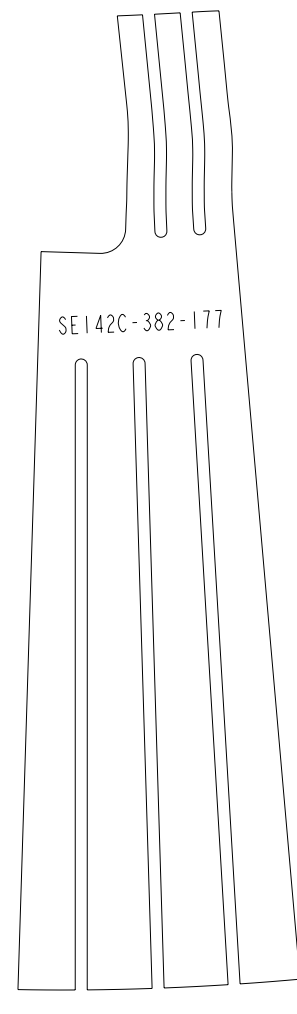

51

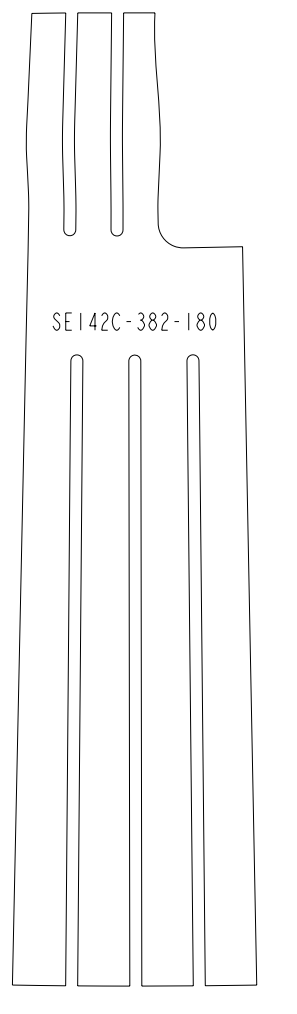
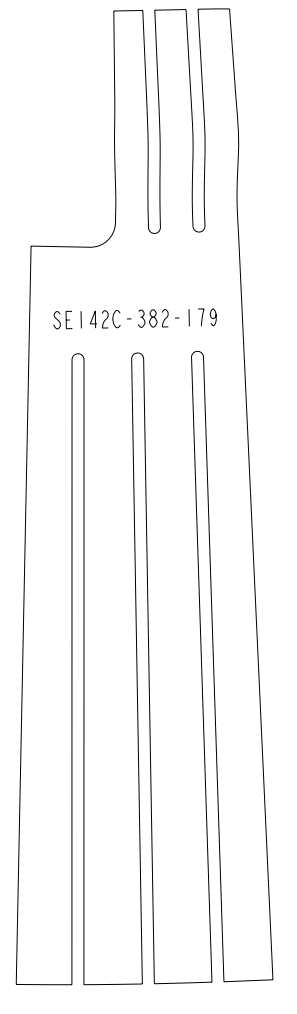

52

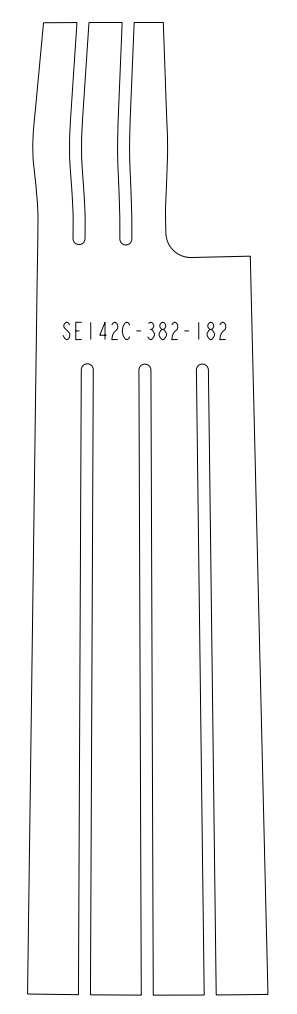
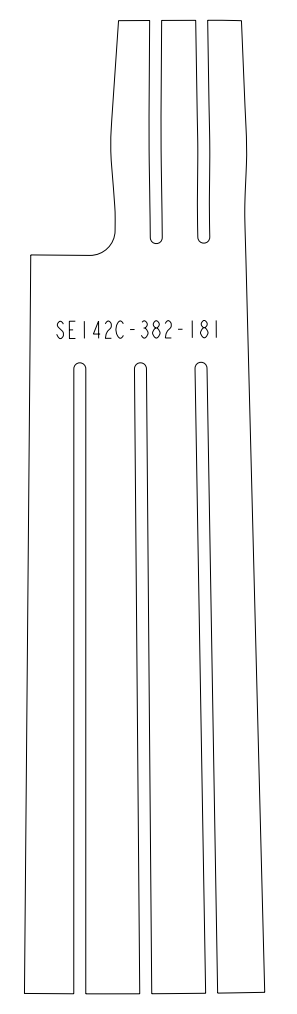

53

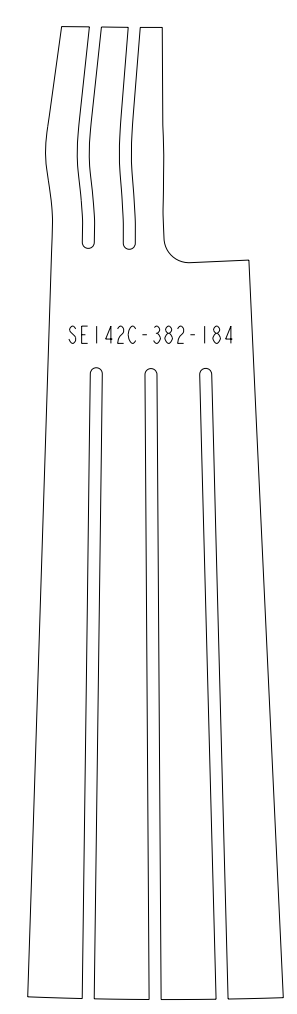
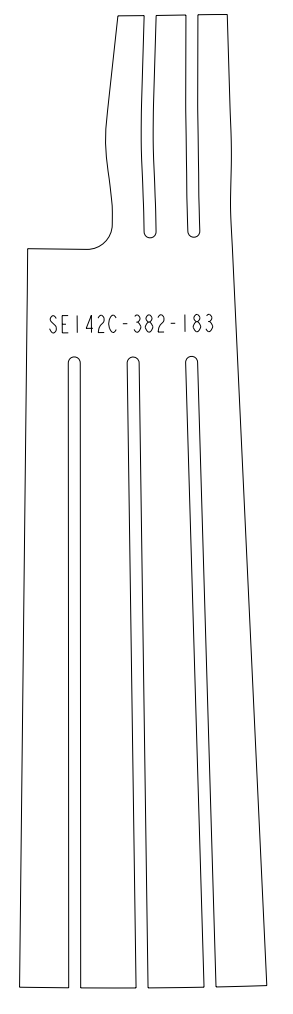

54

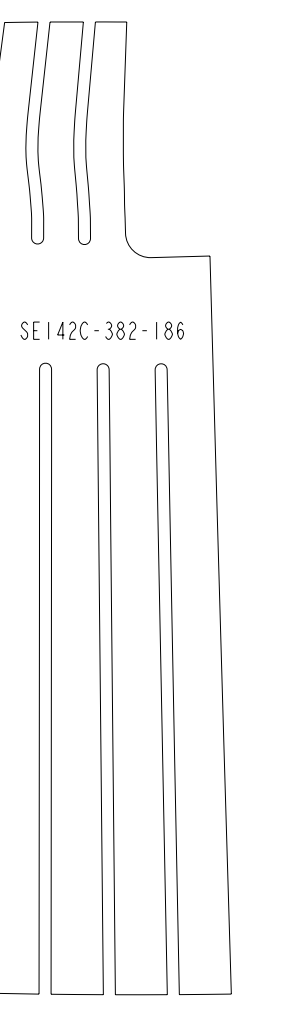
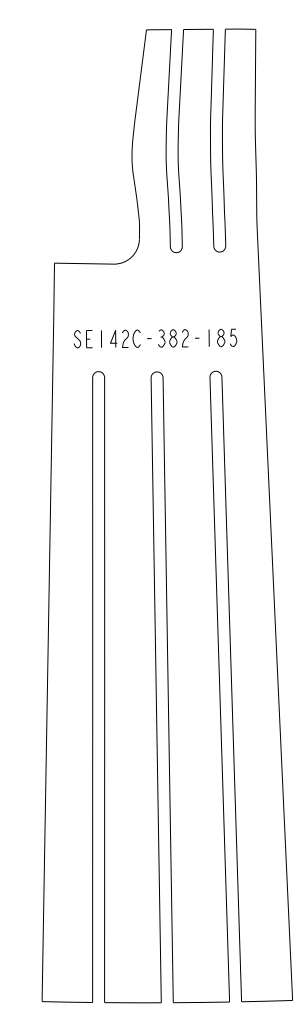

55

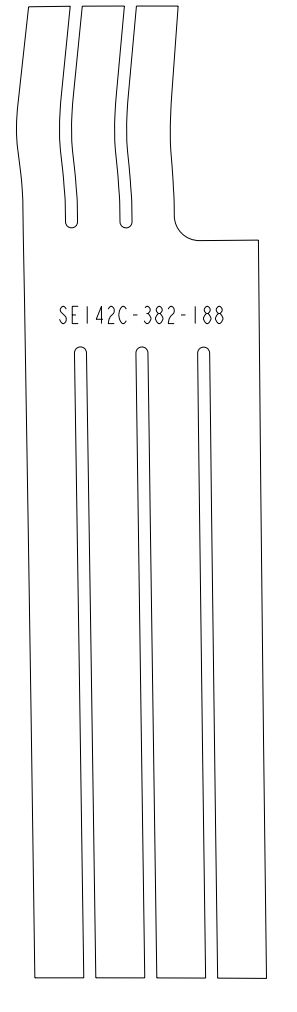
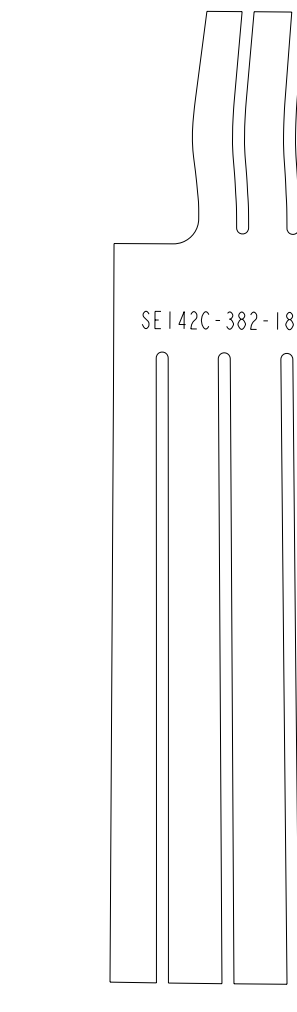

56

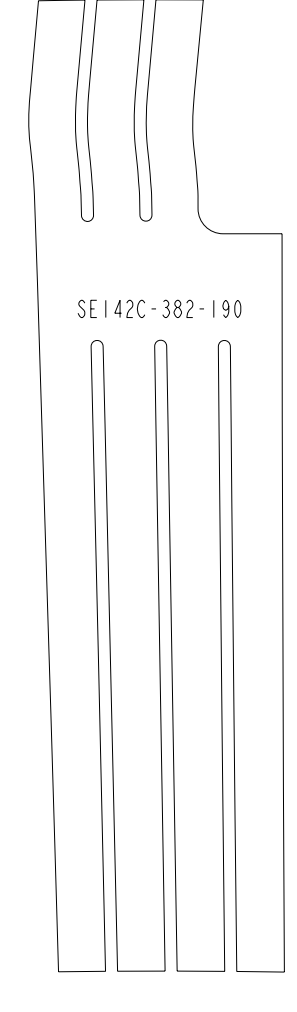
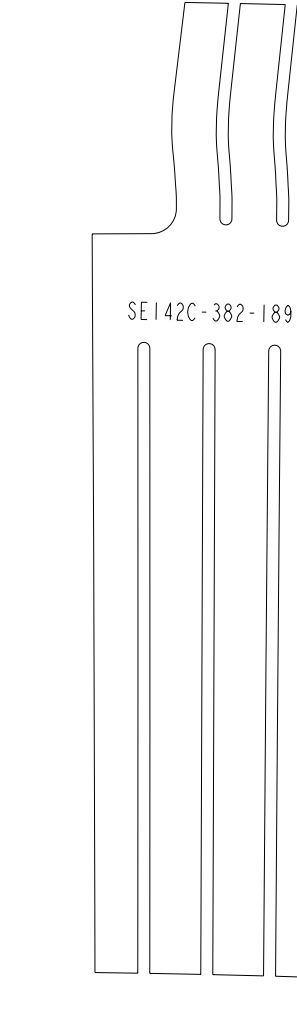

57

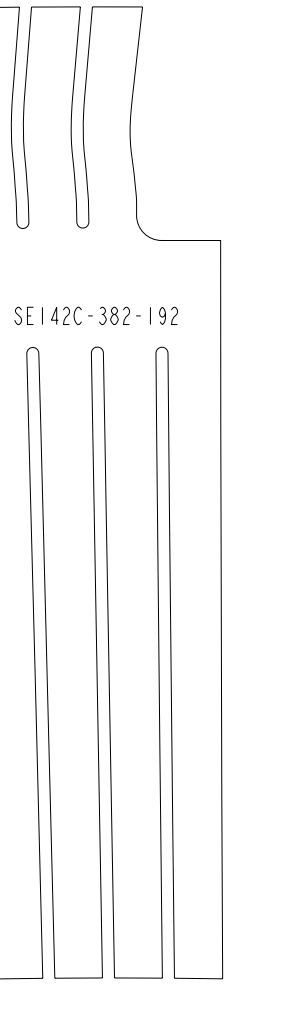
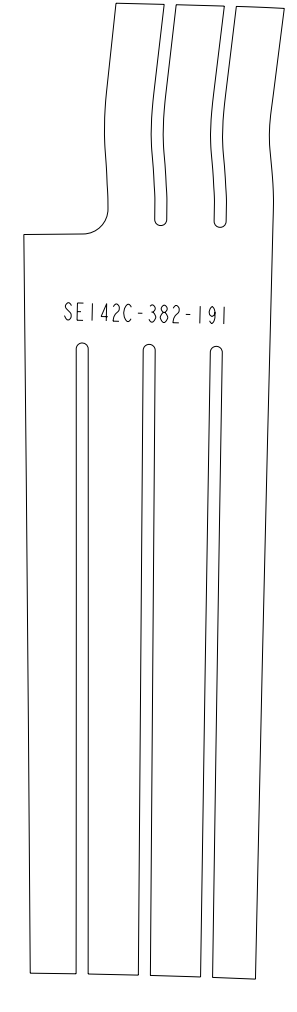

58

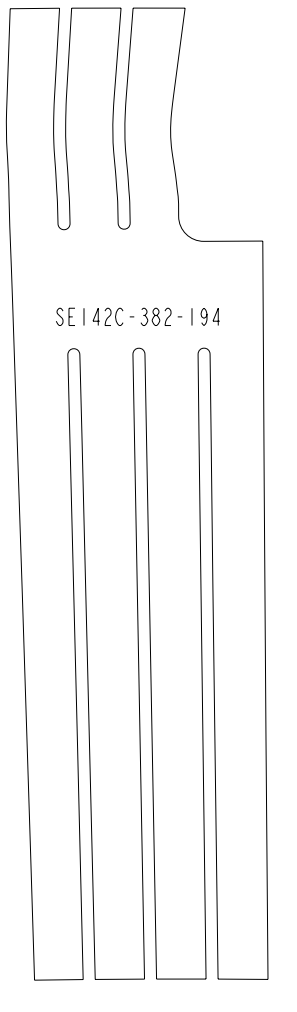
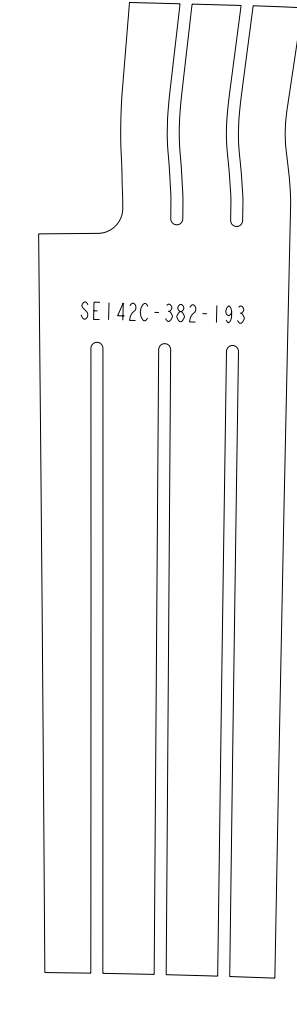

59

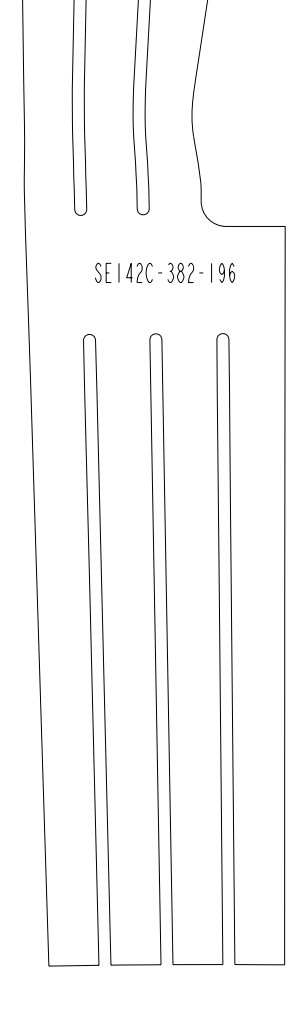
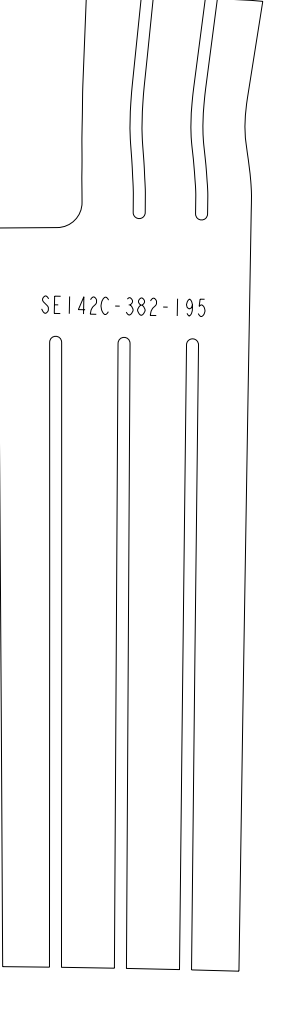

60

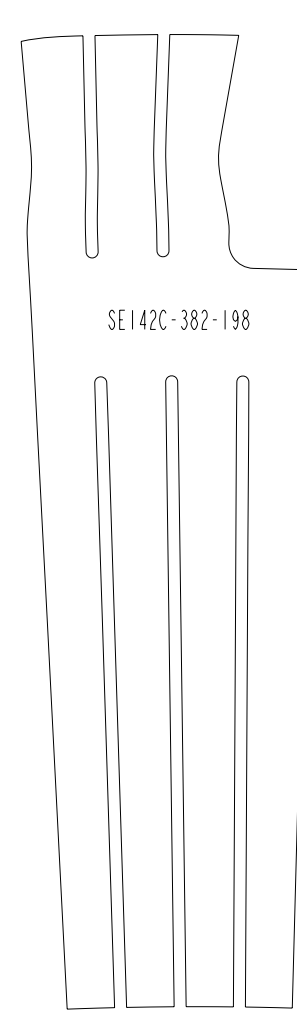
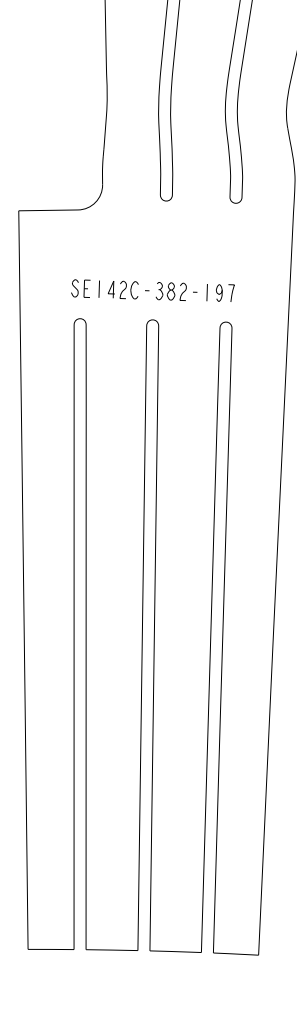

61

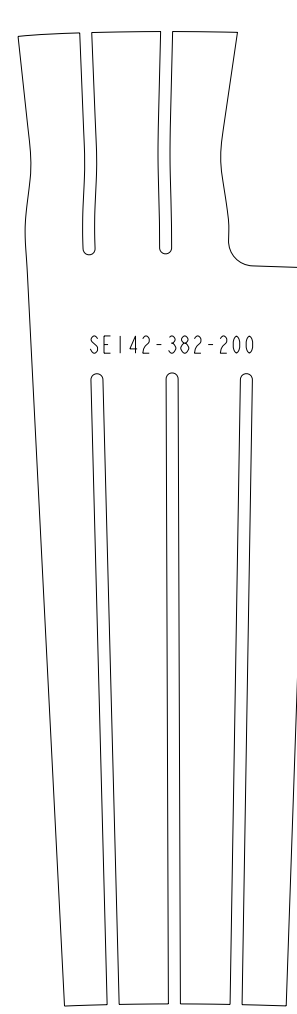
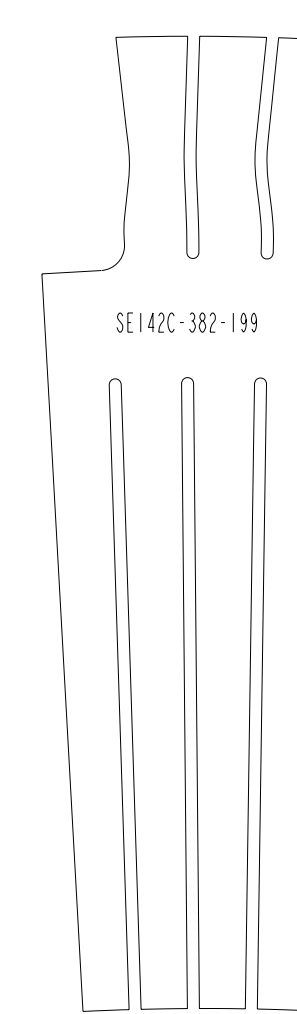

62

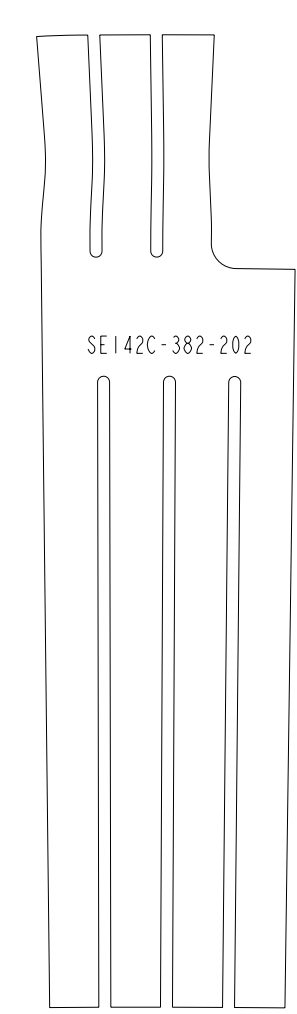
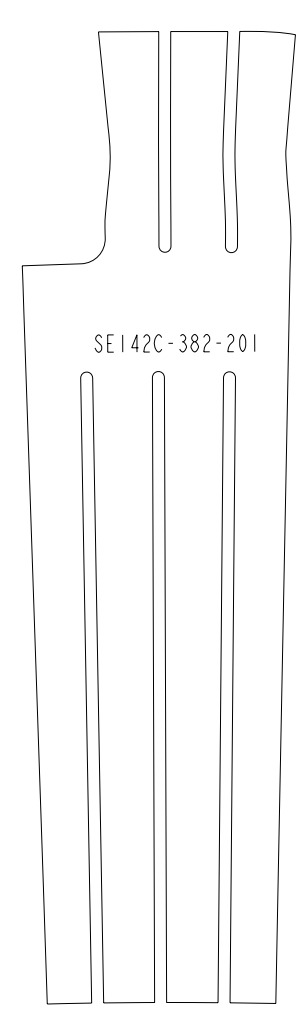

63

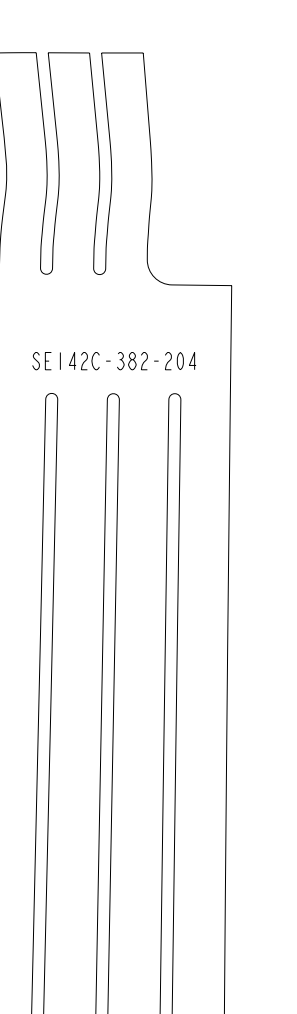
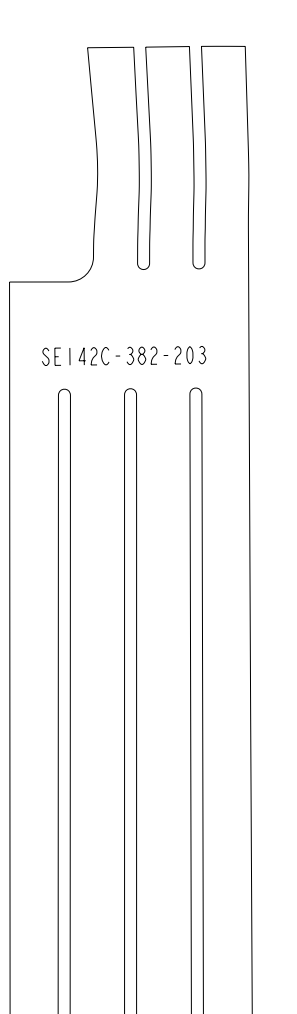

64

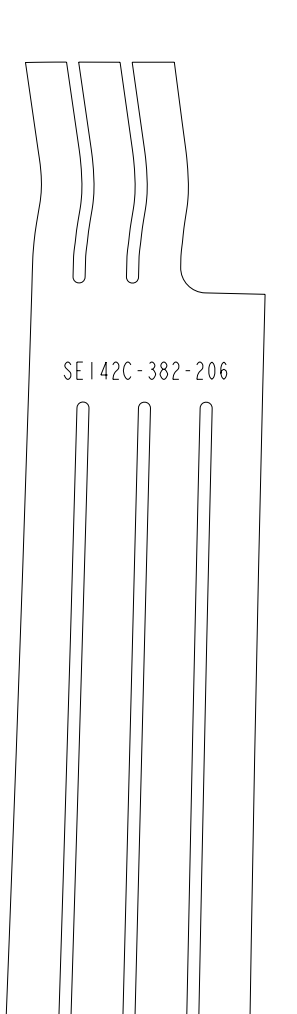
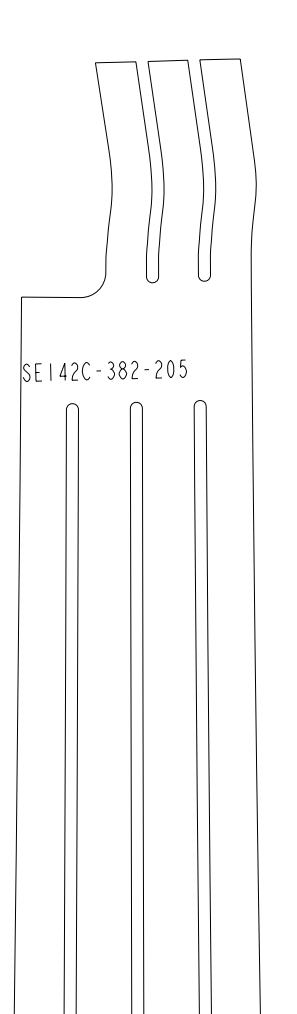

65

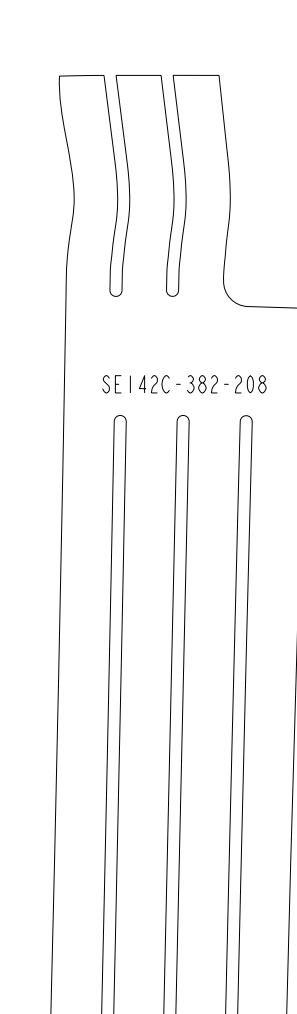
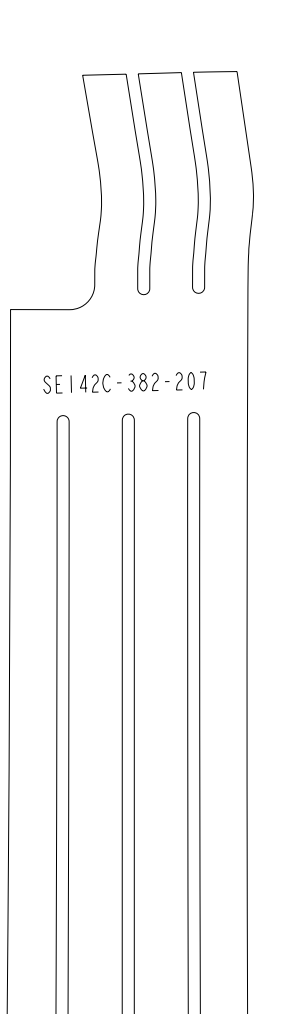

66

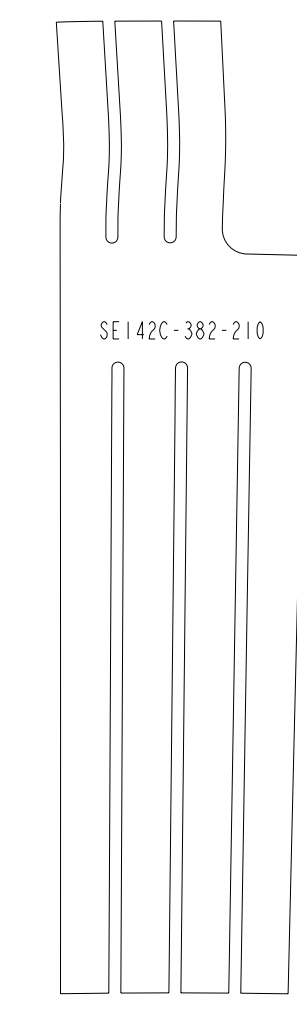
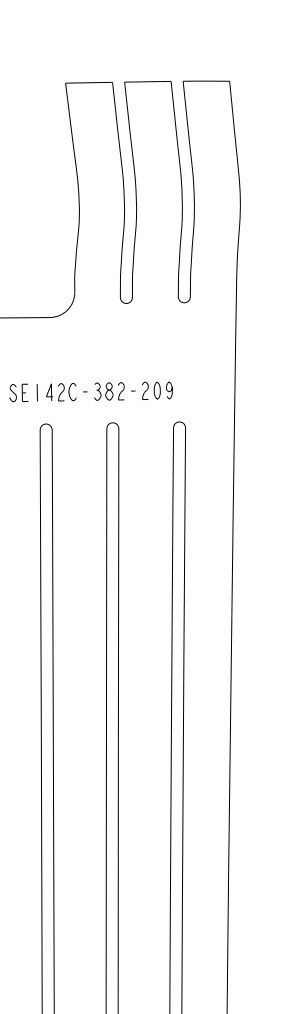

67

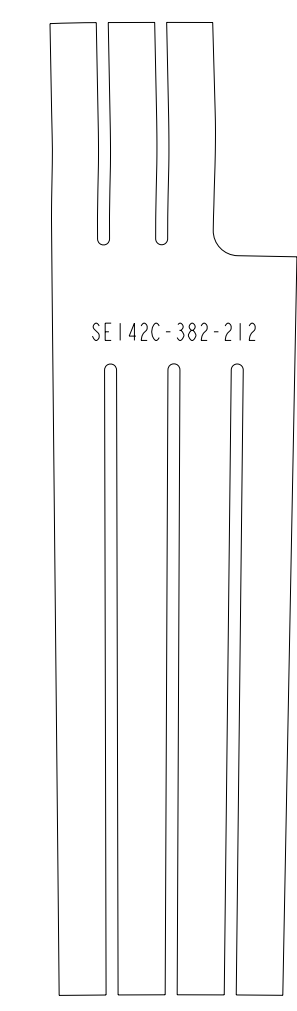
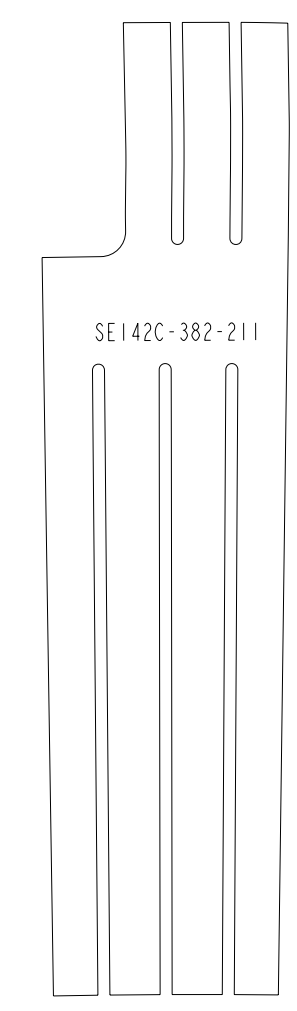

68

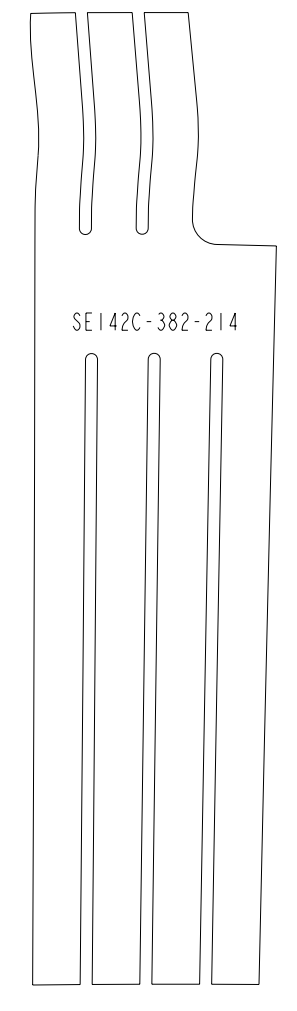
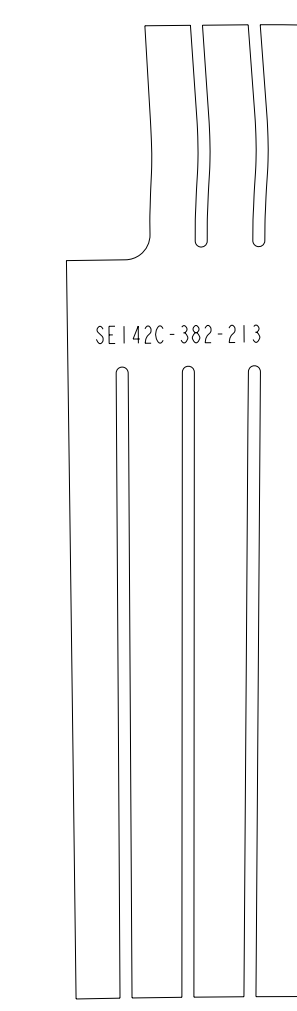

69

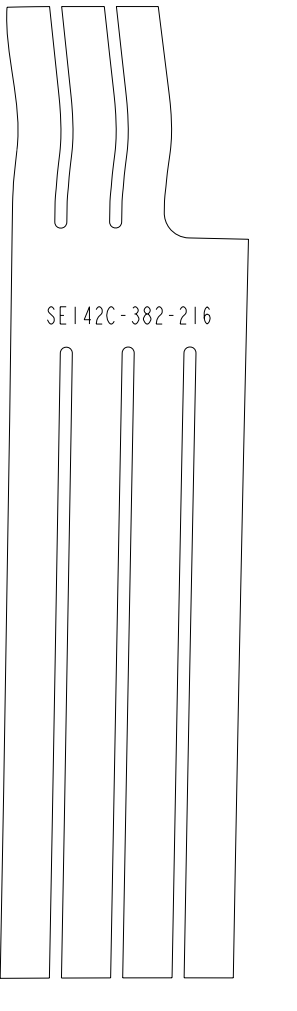
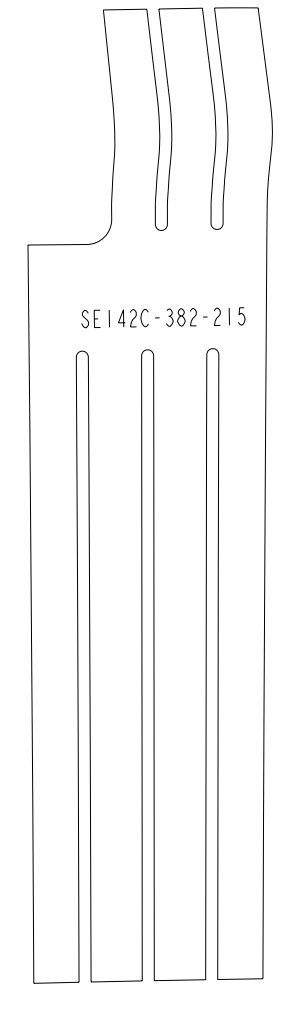

70

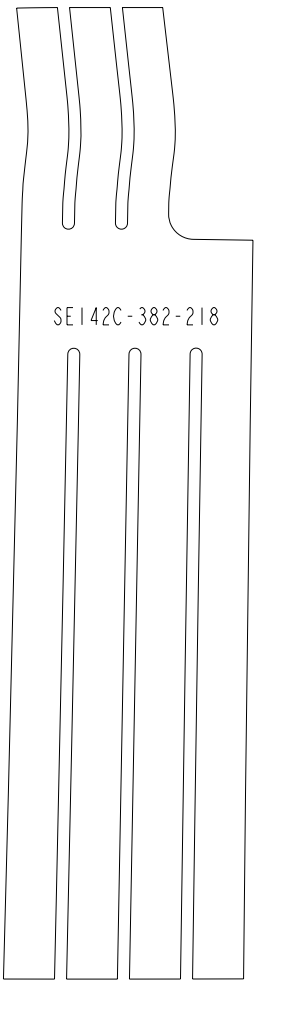
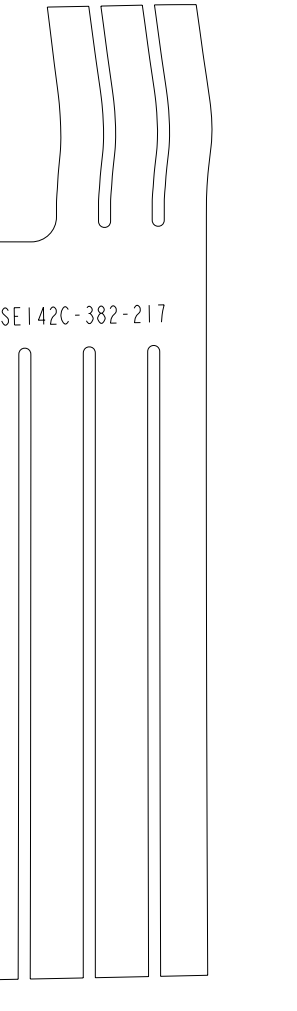

71

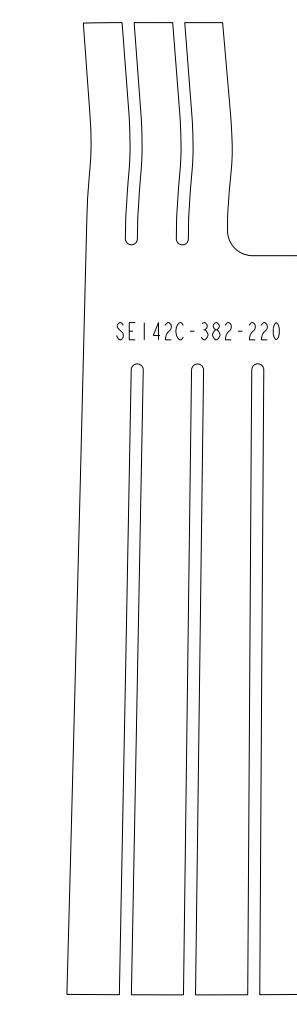
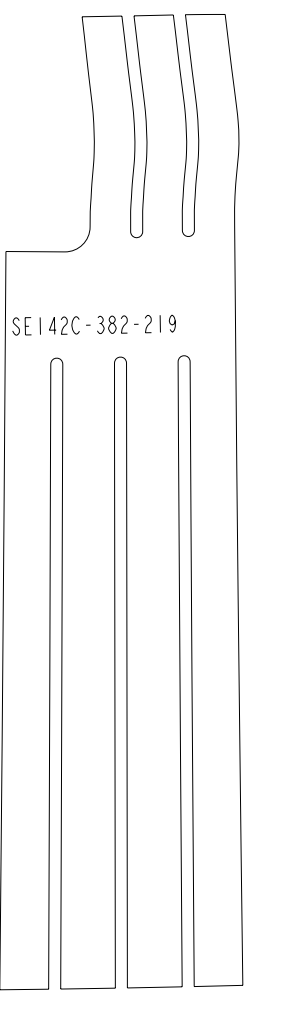

72

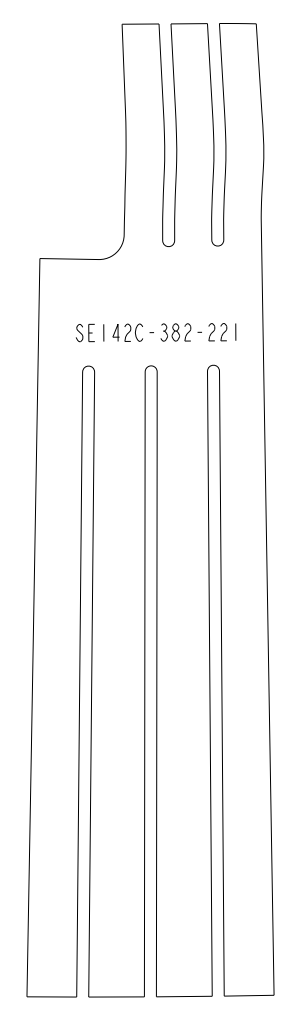

Oak Ridge National Laboratory
managed for the DEPARTMENT OF ENERGY under
U.S. GOVERNMENT CONTRACT DE-AC05-00OR22725
UT-BATTELLE, LLC, Oak Ridge, Tennessee
PROJECT NAME

UT-BATTELLE

NATIONAL COMPACT STELLARATOR EXPERIMENT

MODULAR COIL TYPE-C
SIDE-A UPPER CLADDING
FLAT PATTERN LAYOUT

VERSION NO. 4	PLANT X-10	BLDG 5700	FL 3	SHT OF 4	TYPE S	CLASS U
RELEASE LEVEL WIP		SE142C-382			REV I	

8

7

6

5

4

3

2

1

SE142C-382-221

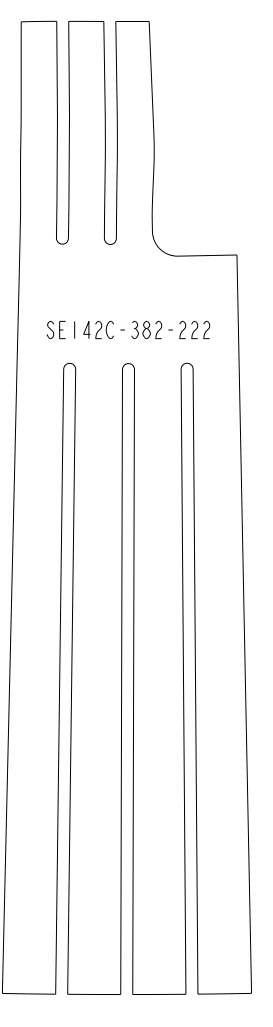
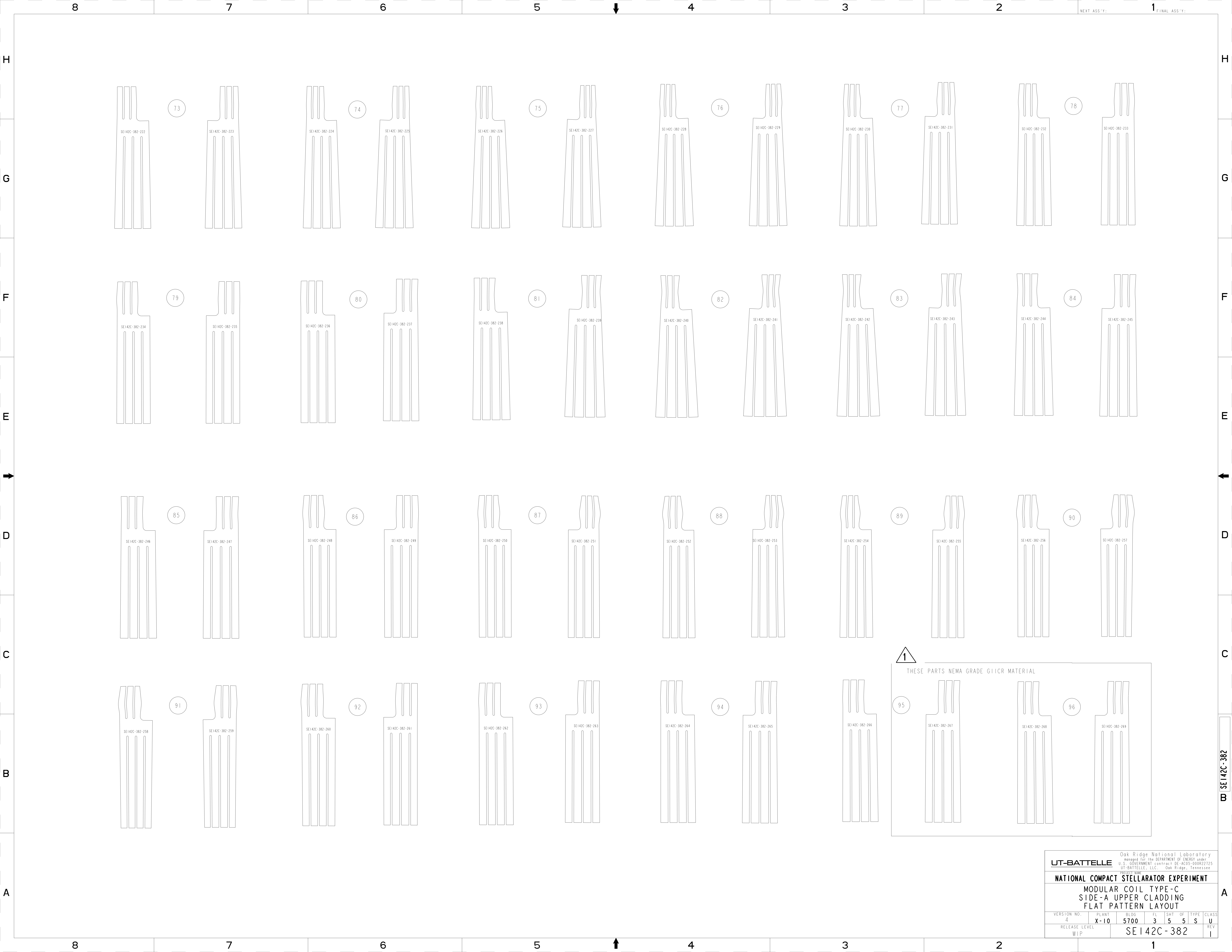

73

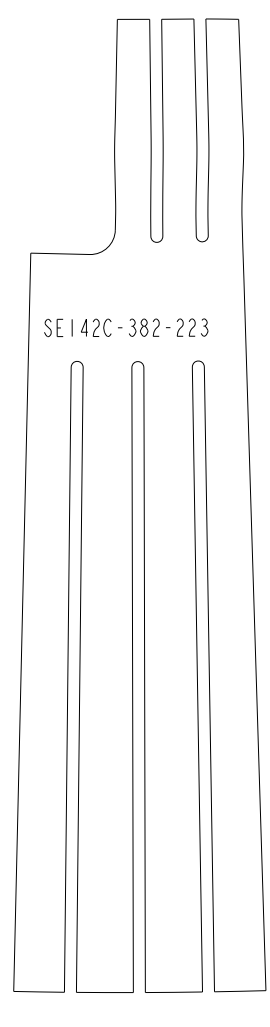

74

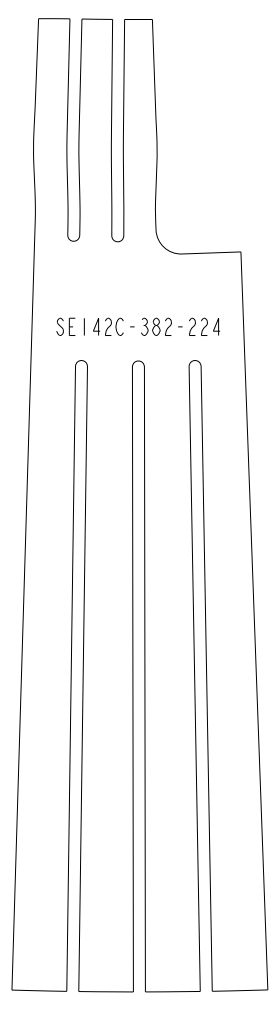

75

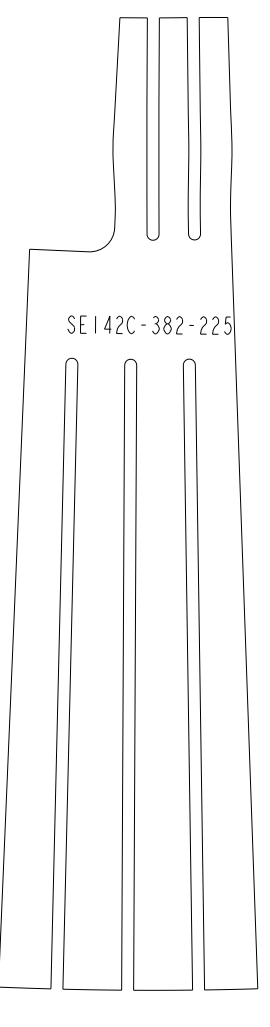

76

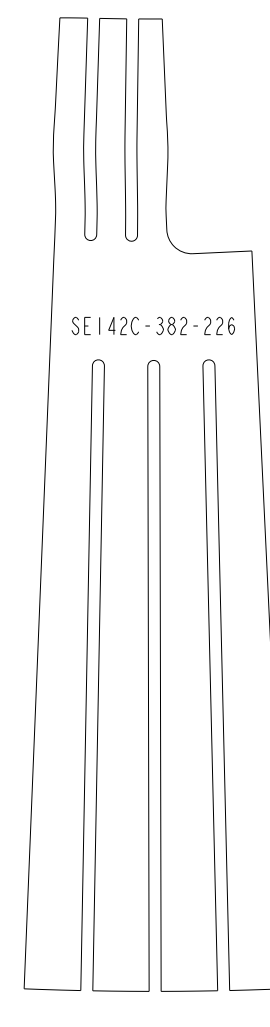

77

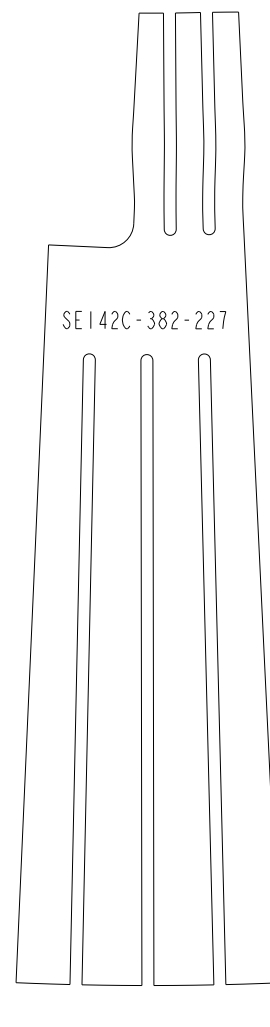

78

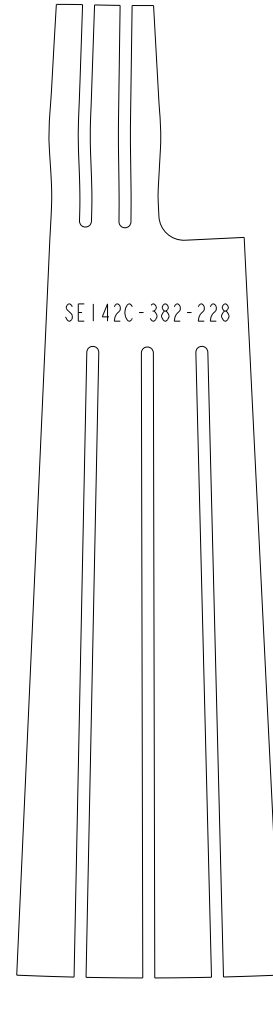

79

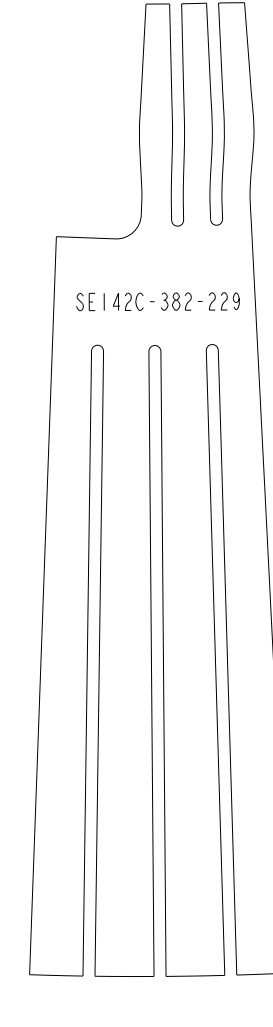

80

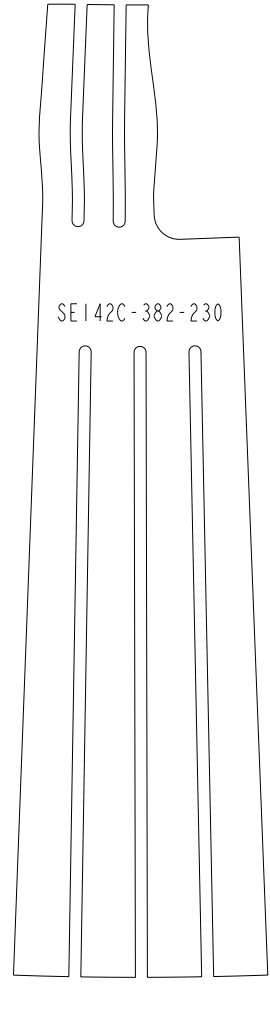

81

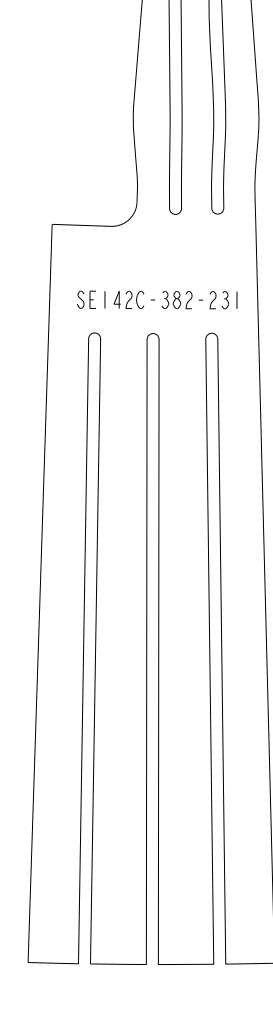

82

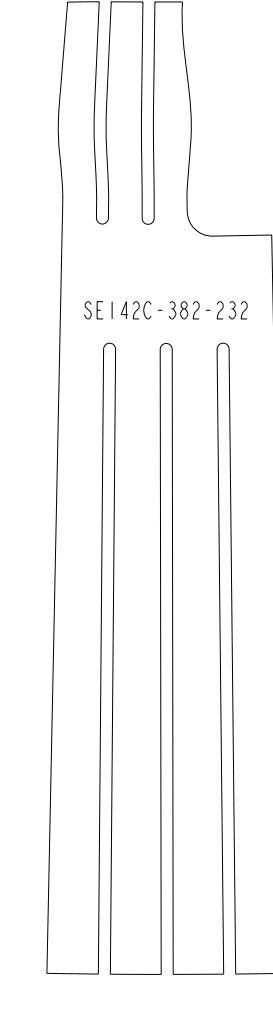

83

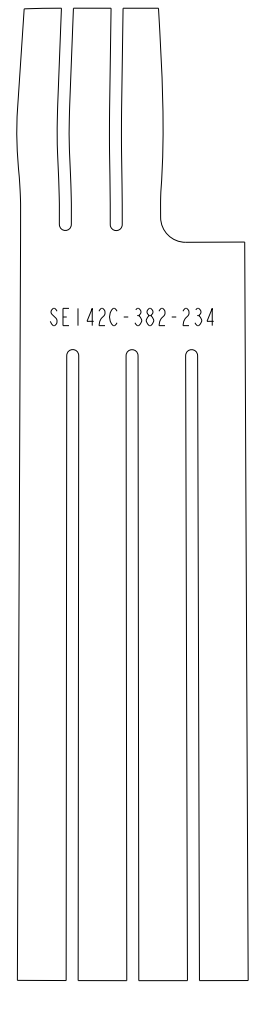
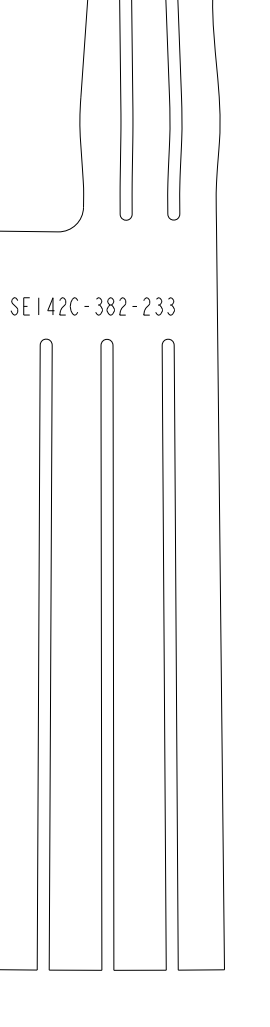

85

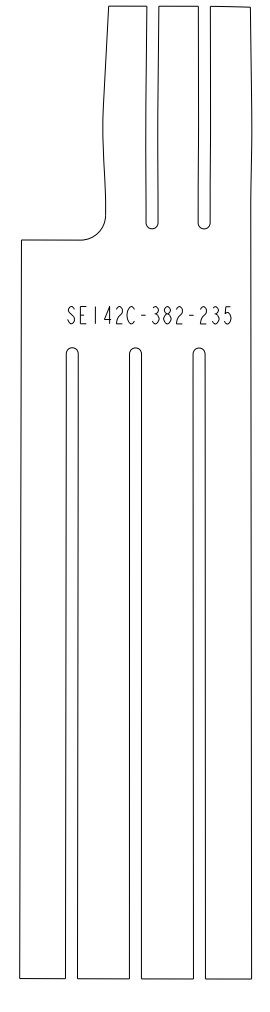

86

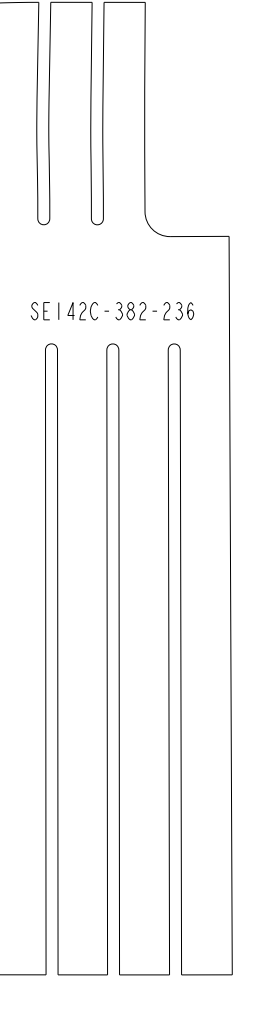

87

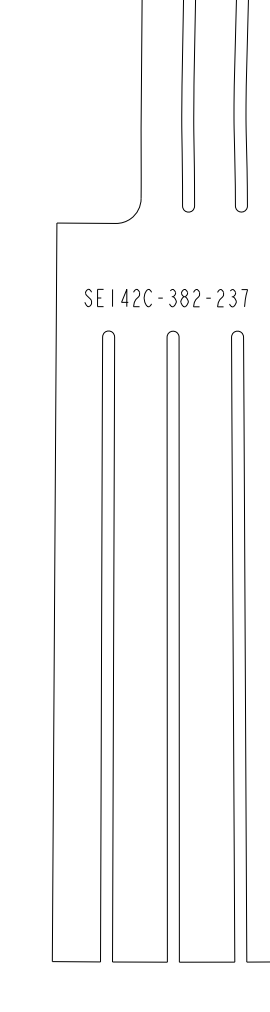

88

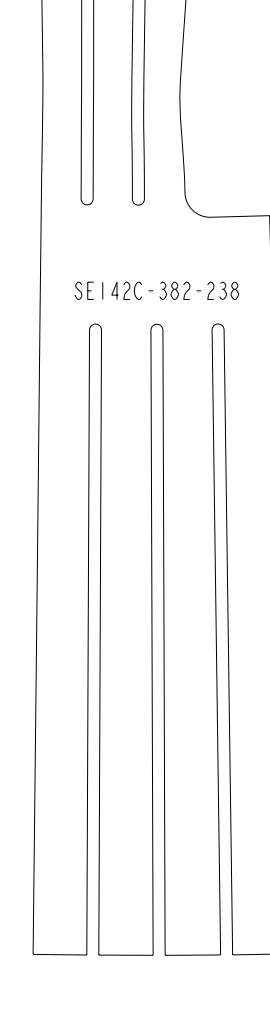

89

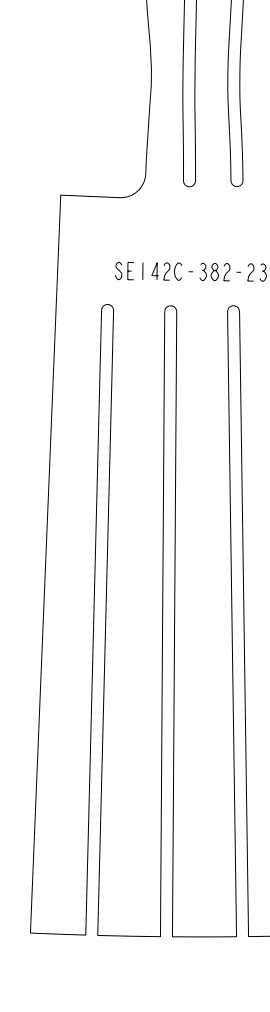

90

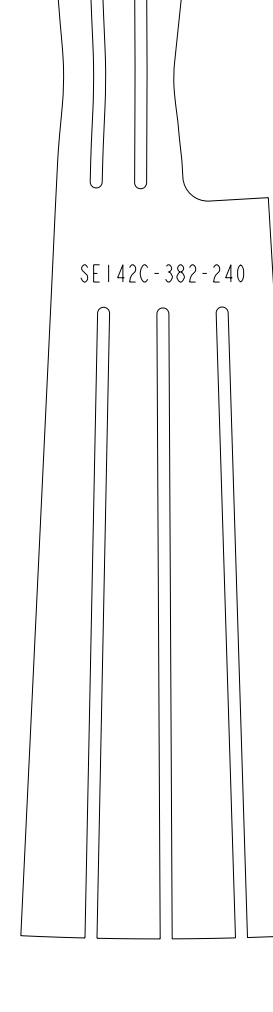

91

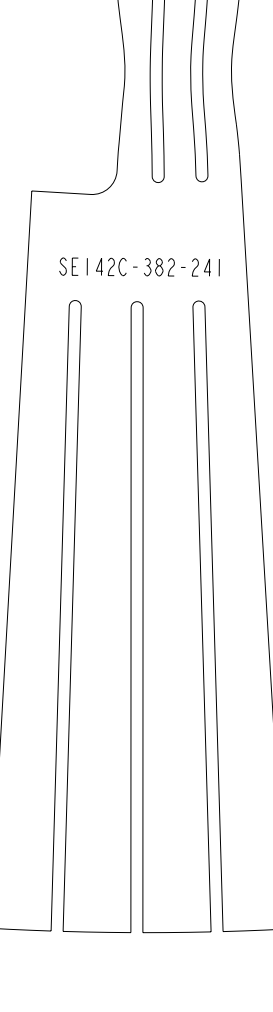

92

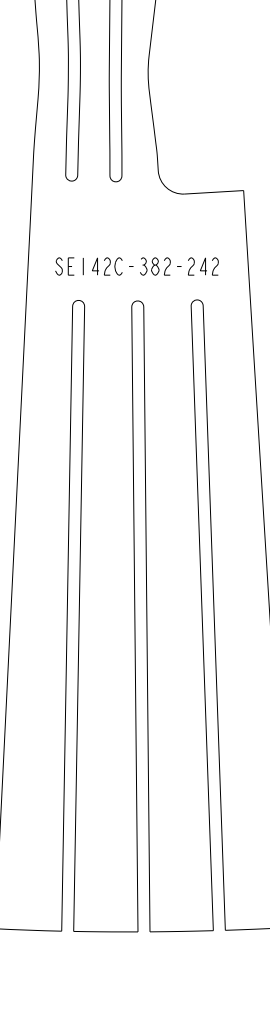

93

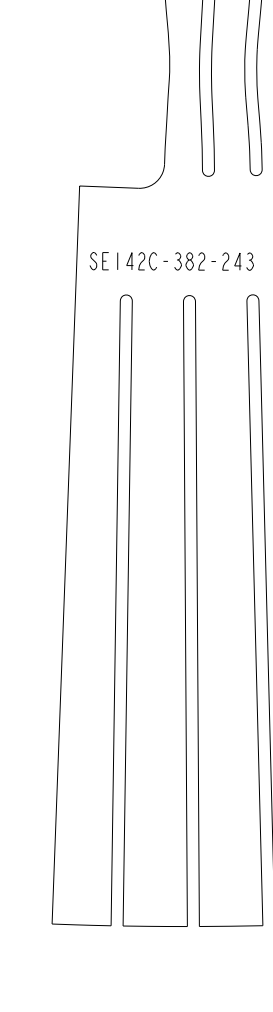

94

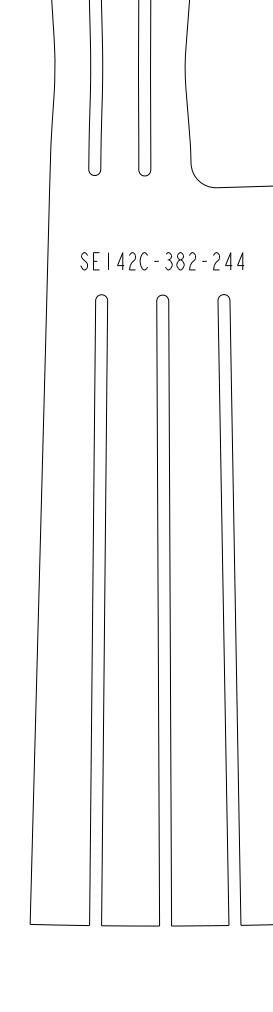

95

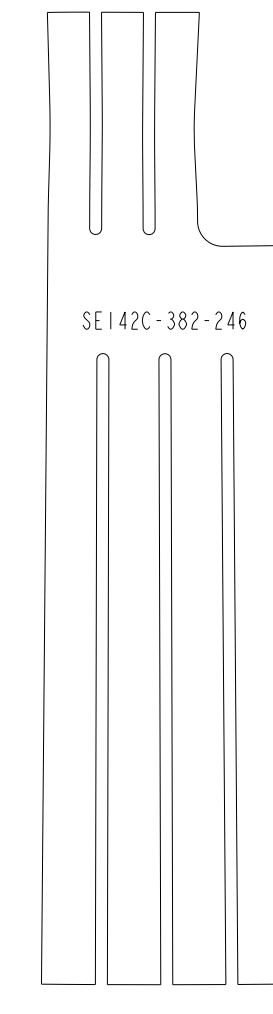
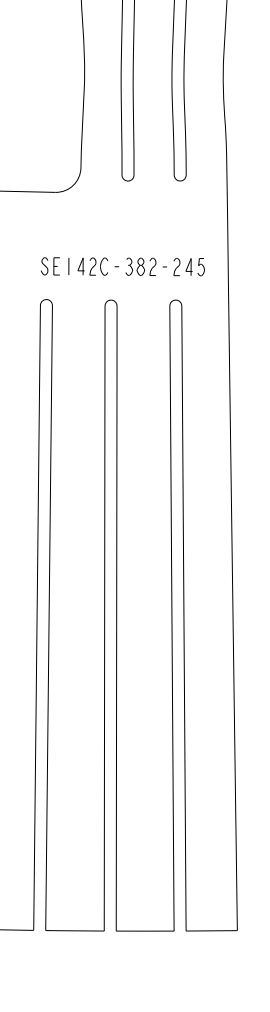

95

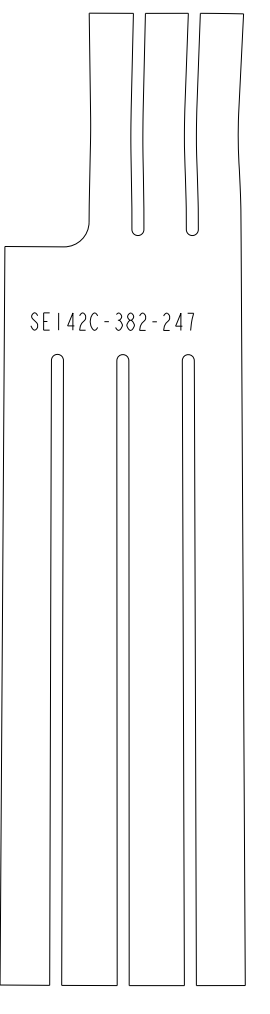

96

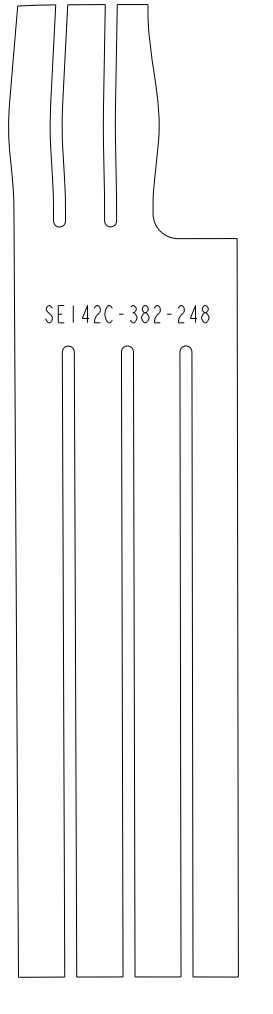

97

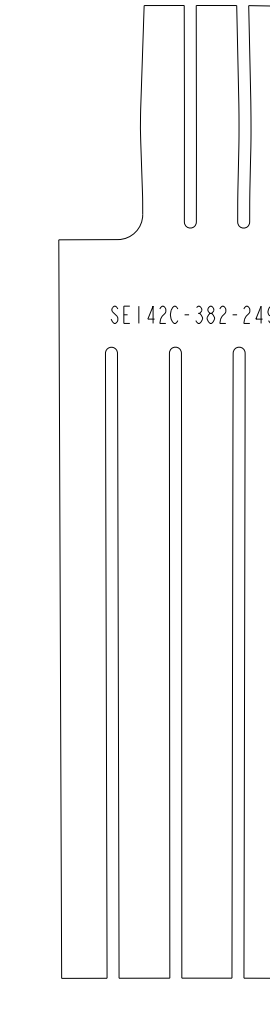

98

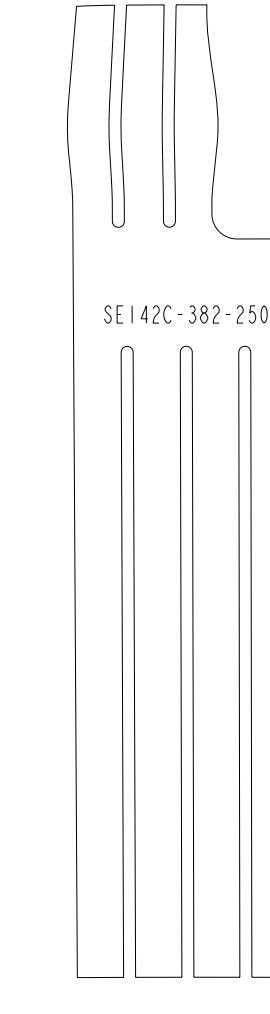

99

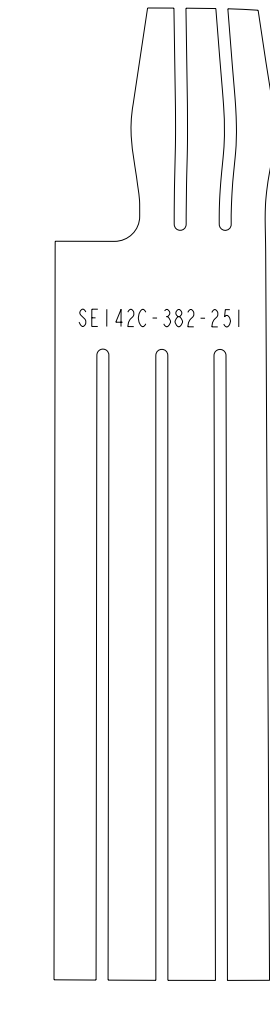

100

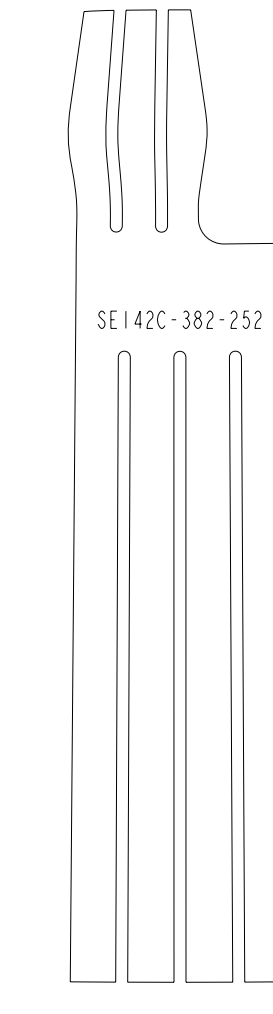

101

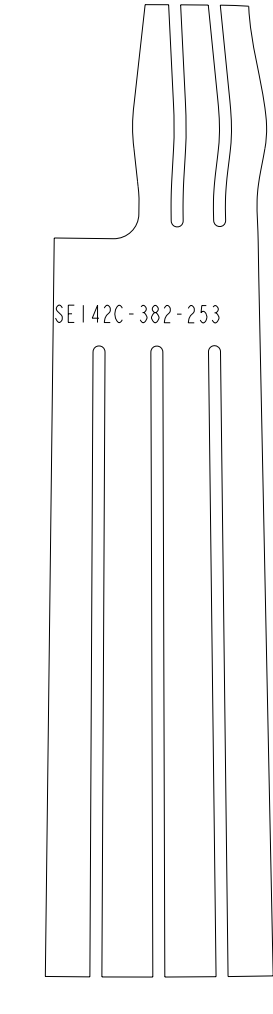

102

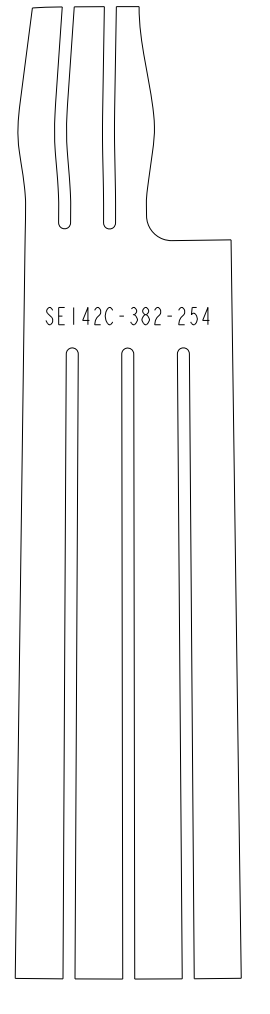

103

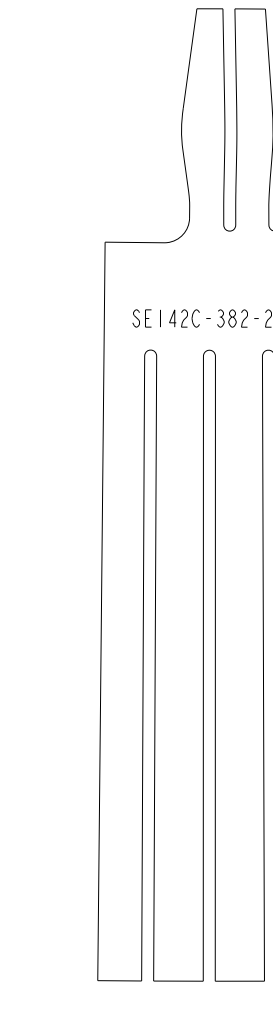

104

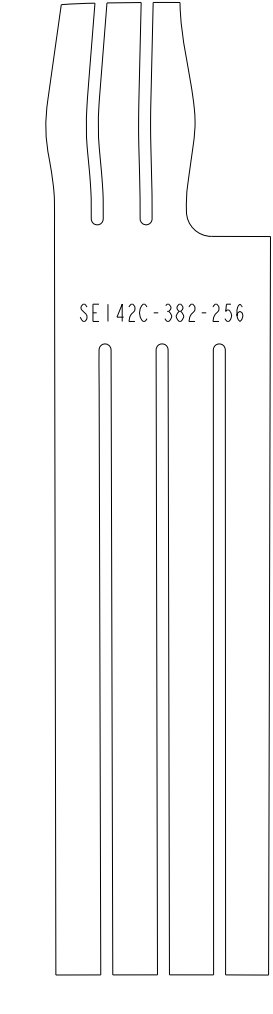

105

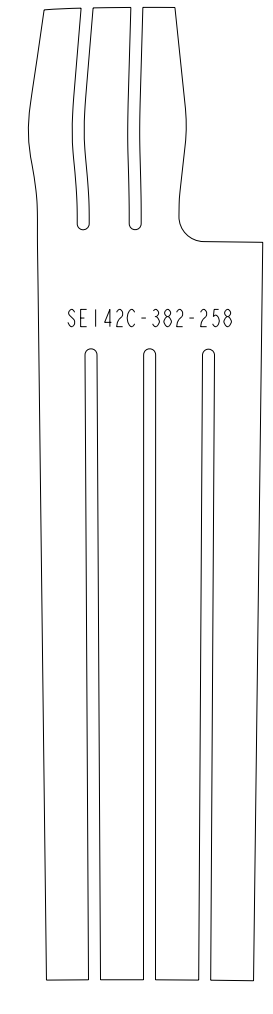
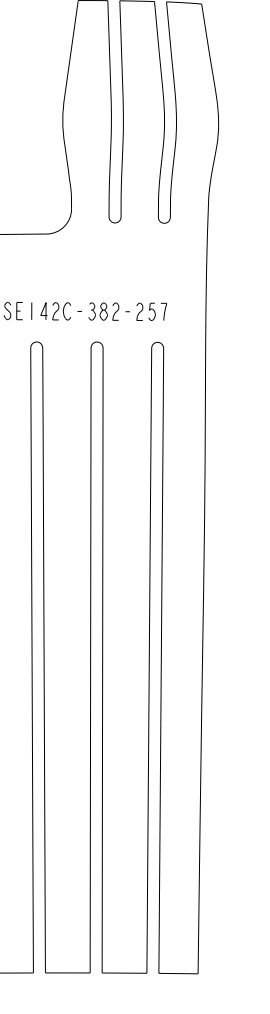

107

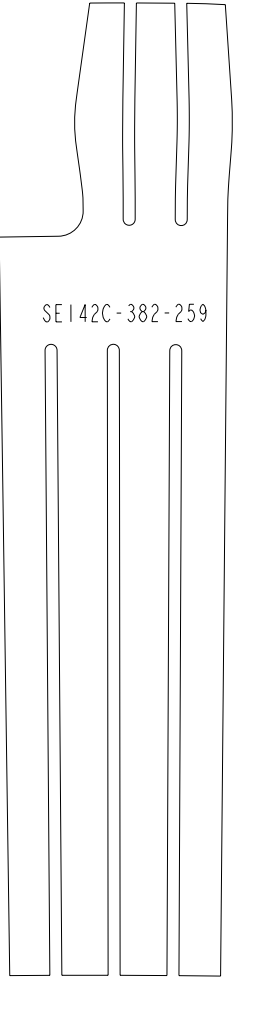

108

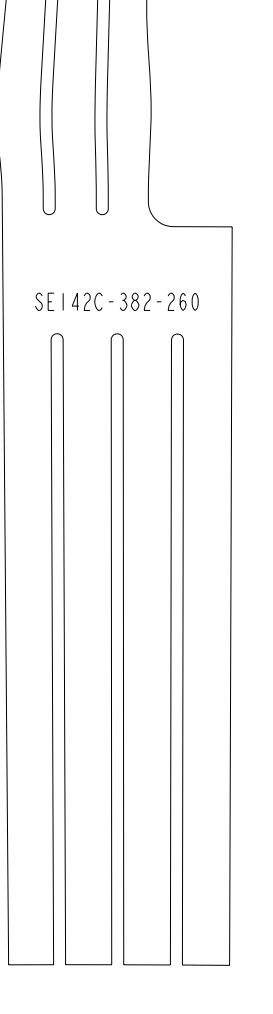

109

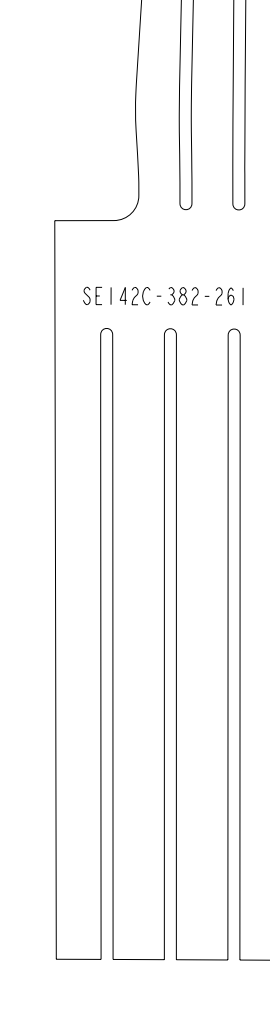

110

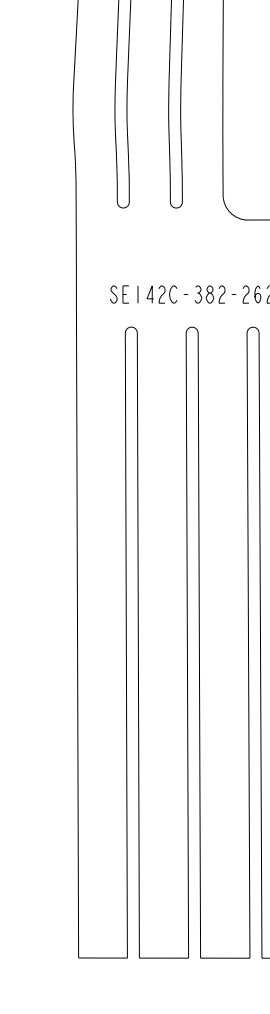

111

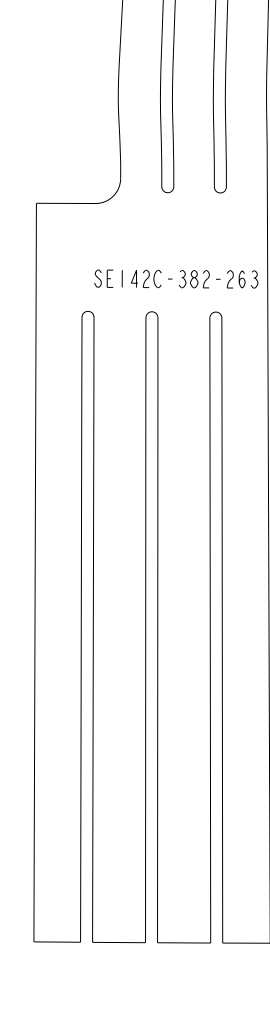

112

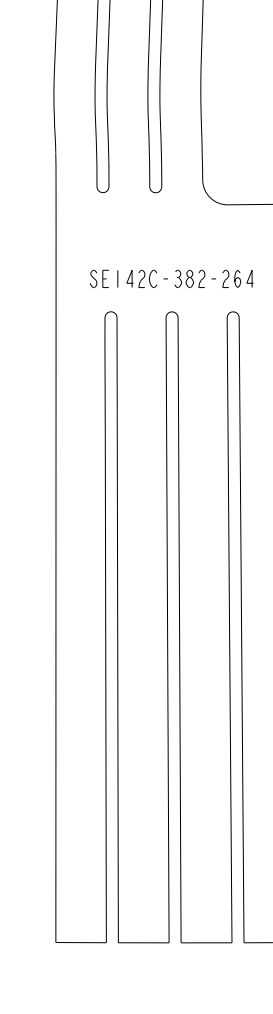

113

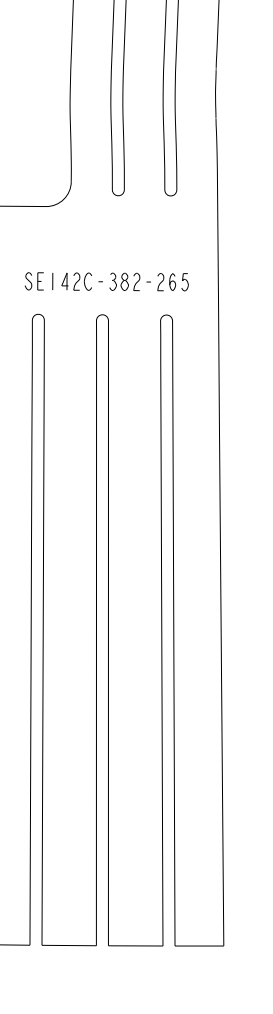

114

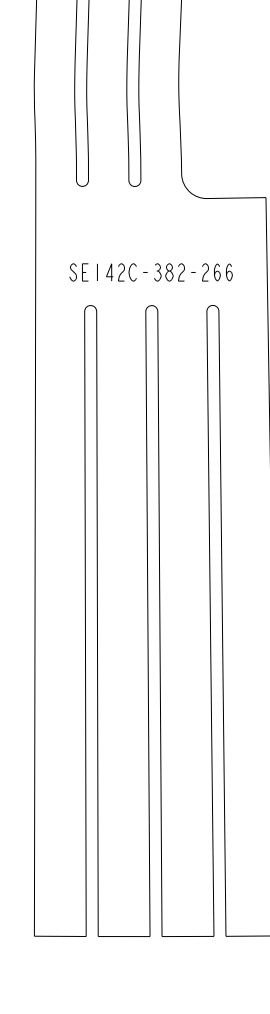

115

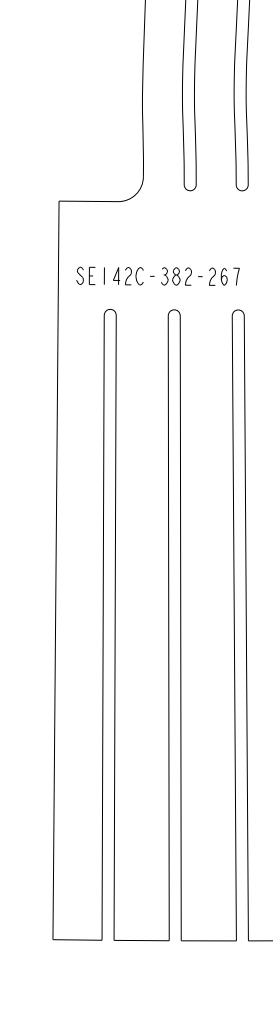

116

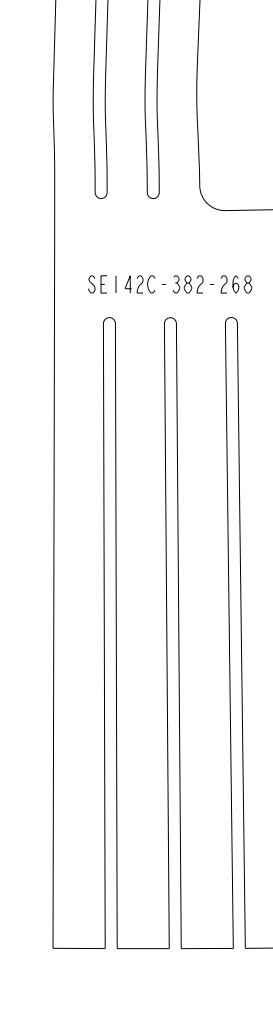

117

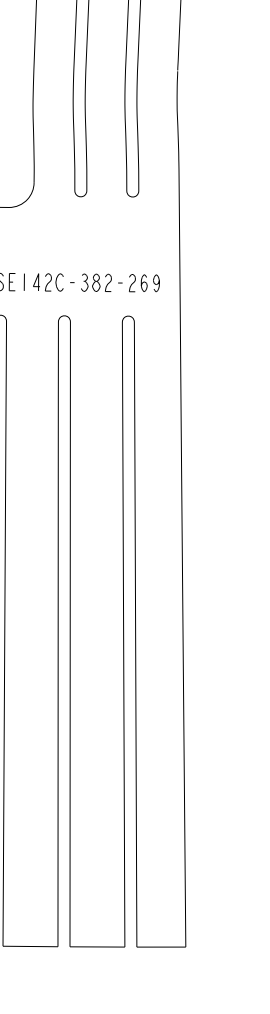

1

THESE PARTS NEMA GRADE GIICR MATERIAL

UT-BATTELLE		Oak Ridge National Laboratory managed for the DEPARTMENT OF ENERGY under U.S. GOVERNMENT contract DE-AC05-00OR22725 UT-BATTELLE, LLC, Oak Ridge, Tennessee					
PROJECT NAME		NATIONAL COMPACT STELLARATOR EXPERIMENT					
SUBPROJECT		MODULAR COIL TYPE-C SIDE-A UPPER CLADDING FLAT PATTERN LAYOUT					
VERSION NO.	PLANT	BLDG	FL	SHT	OF	TYPE	CLASS
4	X-10	5700	3	5	5	S	U
RELEASE LEVEL		SEI42C-382				REV	
WIP						I	