

INSTANCE NAME	HOLE	S-DIM	PART NAME
SEI42C-384-FLAT-270	1	0.885417	SEI42C-384-270
SEI42C-384-FLAT-271		0.890625	SEI42C-384-271
SEI42C-384-FLAT-272		0.895833	SEI42C-384-272
SEI42C-384-FLAT-273	2	0.901042	SEI42C-384-273
SEI42C-384-FLAT-274		0.906250	SEI42C-384-274
SEI42C-384-FLAT-275	3	0.911458	SEI42C-384-275
SEI42C-384-FLAT-276		0.916667	SEI42C-384-276
SEI42C-384-FLAT-277	4	0.921875	SEI42C-384-277
SEI42C-384-FLAT-278		0.927083	SEI42C-384-278
SEI42C-384-FLAT-279	5	0.932292	SEI42C-384-279
SEI42C-384-FLAT-280		0.937500	SEI42C-384-280
SEI42C-384-FLAT-281	6	0.942708	SEI42C-384-281
SEI42C-384-FLAT-282		0.947917	SEI42C-384-282
SEI42C-384-FLAT-283	7	0.953125	SEI42C-384-283
SEI42C-384-FLAT-284		0.958333	SEI42C-384-284
SEI42C-384-FLAT-285	8	0.963542	SEI42C-384-285
SEI42C-384-FLAT-286		0.968750	SEI42C-384-286
SEI42C-384-FLAT-287	9	0.973958	SEI42C-384-287
SEI42C-384-FLAT-288		0.979167	SEI42C-384-288
SEI42C-384-FLAT-289	10	0.984375	SEI42C-384-289
SEI42C-384-FLAT-290		0.989583	SEI42C-384-290
SEI42C-384-FLAT-291	11	0.994792	SEI42C-384-291
SEI42C-384-FLAT-290-NEW		0.000000	SEI42C-384-290
SEI42C-384-FLAT-101	12	0.005208	SEI42C-384-101
SEI42C-384-FLAT-102		0.010417	SEI42C-384-102
SEI42C-384-FLAT-103-NEW	13	0.015625	SEI42C-384-103
SEI42C-384-FLAT-NEW-104		0.019341	SEI42C-384-104
SEI42C-384-FLAT-105	14	0.024000	SEI42C-384-105
SEI42C-384-FLAT-NEW-106		0.024579	SEI42C-384-106
SEI42C-384-FLAT-NEW-107	15	0.036000	SEI42C-384-107
SEI42C-384-FLAT-107-108		0.041000	SEI42C-384-108
SEI42C-384-FLAT-109	16	0.046875	SEI42C-384-109
SEI42C-384-FLAT-110		0.052083	SEI42C-384-110
SEI42C-384-FLAT-111	17	0.057292	SEI42C-384-111
SEI42C-384-FLAT-112		0.062500	SEI42C-384-112
SEI42C-384-FLAT-113	18	0.067708	SEI42C-384-113
SEI42C-384-FLAT-114		0.072917	SEI42C-384-114
SEI42C-384-FLAT-115	19	0.078125	SEI42C-384-115
SEI42C-384-FLAT-116		0.083333	SEI42C-384-116
SEI42C-384-FLAT-117	20	0.088542	SEI42C-384-117
SEI42C-384-FLAT-118		0.093750	SEI42C-384-118
SEI42C-384-FLAT-119	21	0.098958	SEI42C-384-119
SEI42C-384-FLAT-120		0.104167	SEI42C-384-120
SEI42C-384-FLAT-121	22	0.109375	SEI42C-384-121
SEI42C-384-FLAT-122		0.114583	SEI42C-384-122
SEI42C-384-FLAT-123	23	0.119792	SEI42C-384-123
SEI42C-384-FLAT-124		0.125000	SEI42C-384-124
SEI42C-384-FLAT-125	24	0.130208	SEI42C-384-125
SEI42C-384-FLAT-126		0.135417	SEI42C-384-126
SEI42C-384-FLAT-127	25	0.140625	SEI42C-384-127
SEI42C-384-FLAT-128		0.145833	SEI42C-384-128
SEI42C-384-FLAT-129	26	0.151042	SEI42C-384-129
SEI42C-384-FLAT-130		0.156250	SEI42C-384-130
SEI42C-384-FLAT-131	27	0.161458	SEI42C-384-131
SEI42C-384-FLAT-132		0.166667	SEI42C-384-132
SEI42C-384-FLAT-133	28	0.171875	SEI42C-384-133
SEI42C-384-FLAT-134		0.177083	SEI42C-384-134
SEI42C-384-FLAT-135	29	0.182292	SEI42C-384-135
SEI42C-384-FLAT-136		0.187500	SEI42C-384-136
SEI42C-384-FLAT-137	30	0.192708	SEI42C-384-137
SEI42C-384-FLAT-138		0.197917	SEI42C-384-138
SEI42C-384-FLAT-139	31	0.203125	SEI42C-384-139
SEI42C-384-FLAT-140		0.208333	SEI42C-384-140
SEI42C-384-FLAT-141	32	0.213542	SEI42C-384-141
SEI42C-384-FLAT-142		0.218750	SEI42C-384-142
SEI42C-384-FLAT-143	33	0.223958	SEI42C-384-143
SEI42C-384-FLAT-144		0.229167	SEI42C-384-144
SEI42C-384-FLAT-145	34	0.234375	SEI42C-384-145
SEI42C-384-FLAT-146		0.239583	SEI42C-384-146
SEI42C-384-FLAT-147	35	0.244792	SEI42C-384-147
SEI42C-384-FLAT-148		0.250000	SEI42C-384-148
SEI42C-384-FLAT-149	36	0.255208	SEI42C-384-149
SEI42C-384-FLAT-150		0.260417	SEI42C-384-150
SEI42C-384-FLAT-151	37	0.265625	SEI42C-384-151
SEI42C-384-FLAT-152		0.270833	SEI42C-384-152
SEI42C-384-FLAT-153	38	0.276042	SEI42C-384-153
SEI42C-384-FLAT-154		0.281250	SEI42C-384-154
SEI42C-384-FLAT-155	39	0.286458	SEI42C-384-155
SEI42C-384-FLAT-156		0.291667	SEI42C-384-156
SEI42C-384-FLAT-157	40	0.296875	SEI42C-384-157
SEI42C-384-FLAT-158		0.302083	SEI42C-384-158
SEI42C-384-FLAT-159	41	0.307292	SEI42C-384-159
SEI42C-384-FLAT-160		0.312500	SEI42C-384-160
SEI42C-384-FLAT-161	42	0.317708	SEI42C-384-161
SEI42C-384-FLAT-162		0.322917	SEI42C-384-162
SEI42C-384-FLAT-163	43	0.328125	SEI42C-384-163
SEI42C-384-FLAT-164		0.333333	SEI42C-384-164
SEI42C-384-FLAT-165	44	0.338542	SEI42C-384-165
SEI42C-384-FLAT-166		0.343750	SEI42C-384-166
SEI42C-384-FLAT-167	45	0.348958	SEI42C-384-167
SEI42C-384-FLAT-168		0.354167	SEI42C-384-168
SEI42C-384-FLAT-169	46	0.359375	SEI42C-384-169
SEI42C-384-FLAT-170		0.364583	SEI42C-384-170
SEI42C-384-FLAT-171	47	0.369792	SEI42C-384-171
SEI42C-384-FLAT-172		0.375000	SEI42C-384-172
SEI42C-384-FLAT-173	48	0.380208	SEI42C-384-173

INSTANCE NAME	HOLE	S-DIM	PART NAME
SEI42C-384-FLAT-174		0.385417	SEI42C-384-174
SEI42C-384-FLAT-175	49	0.390625	SEI42C-384-175
SEI42C-384-FLAT-176		0.395833	SEI42C-384-176
SEI42C-384-FLAT-177	50	0.401042	SEI42C-384-177
SEI42C-384-FLAT-178		0.406250	SEI42C-384-178
SEI42C-384-FLAT-179	51	0.411458	SEI42C-384-179
SEI42C-384-FLAT-180		0.416667	SEI42C-384-180
SEI42C-384-FLAT-181	52	0.421875	SEI42C-384-181
SEI42C-384-FLAT-182		0.427083	SEI42C-384-182
SEI42C-384-FLAT-183	53	0.432292	SEI42C-384-183
SEI42C-384-FLAT-184		0.437500	SEI42C-384-184
SEI42C-384-FLAT-185	54	0.442708	SEI42C-384-185
SEI42C-384-FLAT-186		0.447917	SEI42C-384-186
SEI42C-384-FLAT-187	55	0.453125	SEI42C-384-187
SEI42C-384-FLAT-188		0.458333	SEI42C-384-188
SEI42C-384-FLAT-189	56	0.463542	SEI42C-384-189
SEI42C-384-FLAT-190		0.468750	SEI42C-384-190
SEI42C-384-FLAT-191	57	0.473958	SEI42C-384-191
SEI42C-384-FLAT-192		0.479167	SEI42C-384-192
SEI42C-384-FLAT-193	58	0.484375	SEI42C-384-193
SEI42C-384-FLAT-194		0.489583	SEI42C-384-194
SEI42C-384-FLAT-195-NEW	59	0.494792	SEI42C-384-195
SEI42C-384-FLAT-196		0.500000	SEI42C-384-196
SEI42C-384-FLAT-197	60	0.505208	SEI42C-384-197
SEI42C-384-FLAT-198		0.510417	SEI42C-384-198
SEI42C-384-FLAT-199	61	0.515625	SEI42C-384-199
SEI42C-384-FLAT-198		0.520833	SEI42C-384-200
SEI42C-384-FLAT-201	62	0.526042	SEI42C-384-201
SEI42C-384-FLAT-202		0.531250	SEI42C-384-202
SEI42C-384-FLAT-203	63	0.536458	SEI42C-384-203
SEI42C-384-FLAT-204		0.541667	SEI42C-384-204
SEI42C-384-FLAT-205	64	0.546875	SEI42C-384-205
SEI42C-384-FLAT-206		0.552083	SEI42C-384-206
SEI42C-384-FLAT-207	65	0.557292	SEI42C-384-207
SEI42C-384-FLAT-208		0.562500	SEI42C-384-208
SEI42C-384-FLAT-209	66	0.567708	SEI42C-384-209
SEI42C-384-FLAT-210		0.572917	SEI42C-384-210
SEI42C-384-FLAT-211	67	0.578125	SEI42C-384-211
SEI42C-384-FLAT-212		0.583333	SEI42C-384-212
SEI42C-384-FLAT-213	68	0.588542	SEI42C-384-213
SEI42C-384-FLAT-214		0.593750	SEI42C-384-214
SEI42C-384-FLAT-215	69	0.598958	SEI42C-384-215
SEI42C-384-FLAT-216		0.604167	SEI42C-384-216
SEI42C-384-FLAT-217	70	0.609375	SEI42C-384-217
SEI42C-384-FLAT-218		0.614584	SEI42C-384-218
SEI42C-384-FLAT-219	71	0.619792	SEI42C-384-219
SEI42C-384-FLAT-220		0.625000	SEI42C-384-220
SEI42C-384-FLAT-221	72	0.630209	SEI42C-384-221
SEI42C-384-FLAT-222		0.635417	SEI42C-384-222
SEI42C-384-FLAT-223	73	0.640625	SEI42C-384-223
SEI42C-384-FLAT-224		0.645834	SEI42C-384-224
SEI42C-384-FLAT-225	74	0.651042	SEI42C-384-225
SEI42C-384-FLAT-226		0.656250	SEI42C-384-226
SEI42C-384-FLAT-227	75	0.661458	SEI42C-384-227
SEI42C-384-FLAT-228		0.666667	SEI42C-384-228
SEI42C-384-FLAT-229	76	0.671875	SEI42C-384-229
SEI42C-384-FLAT-230		0.677083	SEI42C-384-230
SEI42C-384-FLAT-231	77	0.682292	SEI42C-384-231
SEI42C-384-FLAT-232		0.687500	SEI42C-384-232
SEI42C-384-FLAT-233	78	0.692708	SEI42C-384-233
SEI42C-384-FLAT-234		0.697917	SEI42C-384-234
SEI42C-384-FLAT-235	79	0.703125	SEI42C-384-235
SEI42C-384-FLAT-236		0.708333	SEI42C-384-236
SEI42C-384-FLAT-237	80	0.713542	SEI42C-384-237
SEI42C-384-FLAT-238		0.718750	SEI42C-384-238
SEI42C-384-FLAT-239	81	0.723958	SEI42C-384-239
SEI42C-384-FLAT-240		0.729167	SEI42C-384-240
SEI42C-384-FLAT-241	82	0.734375	SEI42C-384-241
SEI42C-384-FLAT-242		0.739583	SEI42C-384-242
SEI42C-384-FLAT-243	83	0.744792	SEI42C-384-243
SEI42C-384-FLAT-244		0.750000	SEI42C-384-244
SEI42C-384-FLAT-245	84	0.755208	SEI42C-384-245
SEI42C-384-FLAT-246		0.760417	SEI42C-384-246
SEI42C-384-FLAT-247	85	0.765625	SEI42C-384-247
SEI42C-384-FLAT-248		0.770833	SEI42C-384-248
SEI42C-384-FLAT-249	86	0.776042	SEI42C-384-249
SEI42C-384-FLAT-250		0.781250	SEI42C-384-250
SEI42C-384-FLAT-NEW-251	87	0.786458	SEI42C-384-251
SEI42C-384-FLAT-NEW-252		0.791667	SEI42C-384-252
SEI42C-384-FLAT-NEW-253	88	0.796875	SEI42C-384-253
SEI42C-384-FLAT-NEW-254		0.802083	SEI42C-384-254
SEI42C-384-FLAT-NEW-255	89	0.807292	SEI42C-384-255
SEI42C-384-FLAT-NEW-256		0.812500	SEI42C-384-256
SEI42C-384-FLAT-NEW-257	90	0.817708	SEI42C-384-257
SEI42C-384-FLAT-NEW-258		0.822917	SEI42C-384-258
SEI42C-384-FLAT-NEW-259	91	0.828125	SEI42C-384-259
SEI42C-384-FLAT-260		0.833333	SEI42C-384-260
SEI42C-384-FLAT-261	92	0.838542	SEI42C-384-261
SEI42C-384-FLAT-262		0.843750	SEI42C-384-262
SEI42C-384-FLAT-263	93	0.848958	SEI42C-384-263
SEI42C-384-FLAT-264		0.854167	SEI42C-384-264
SEI42C-384-FLAT-265	94	0.859375	SEI42C-384-265
SEI42C-384-FLAT-266		0.864583	SEI42C-384-266
SEI42C-384-FLAT-267	95	0.869792	SEI42C-384-267
SEI42C-384-FLAT-268		0.875000	SEI42C-384-268
SEI42C-384-FLAT-269	96	0.880208	SEI42C-384-269

- NOTES
- DRAWING PREPARED IN ACCORDANCE WITH ASME Y14.8M-1996.
  - INTERPRET DIMENSIONS AND TOLERANCES PER ANSI Y14.5M-1994.
  - DIMENSIONS ARE IN INCHES.
  - DRAWING DEPICTS FLAT PATTERN OF FORMED PARTS DEFINED BY PRO/ENGINEER FILES SEI42C-384-XXX-FORM.PRT.
  - PROFILE TOLERANCE OF FLAT PATTERN IS +/- .010 IN.</

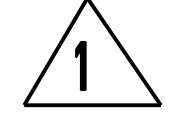

THESE PARTS TO BE NEMA GRADE GIICR MATERIAL

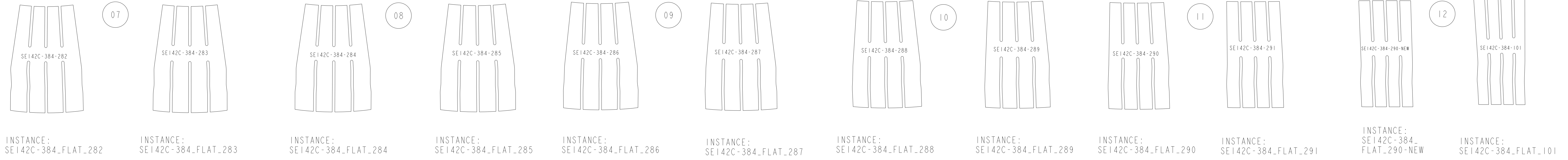
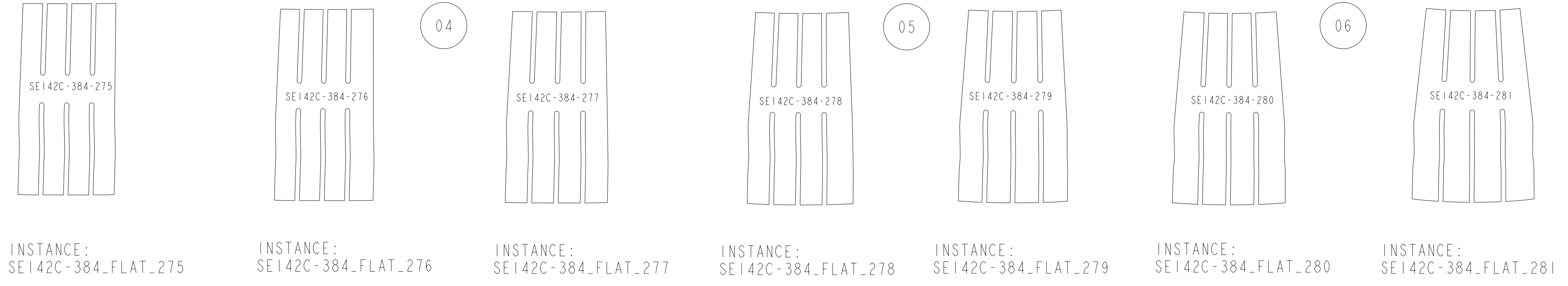
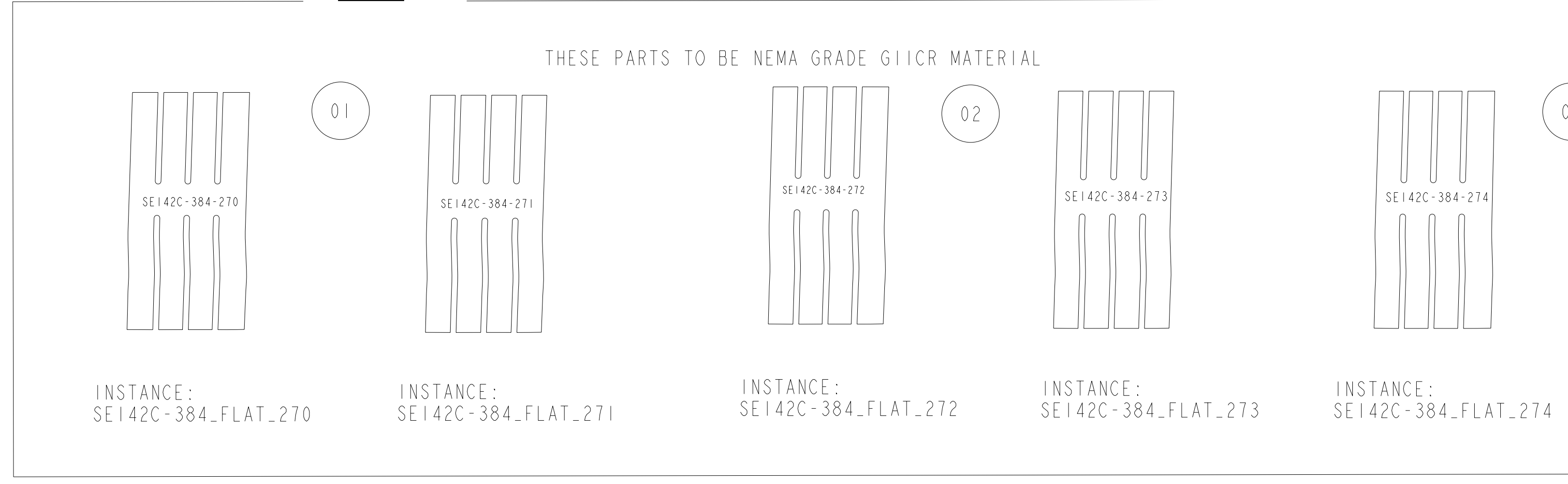

POLOIDAL BREAK

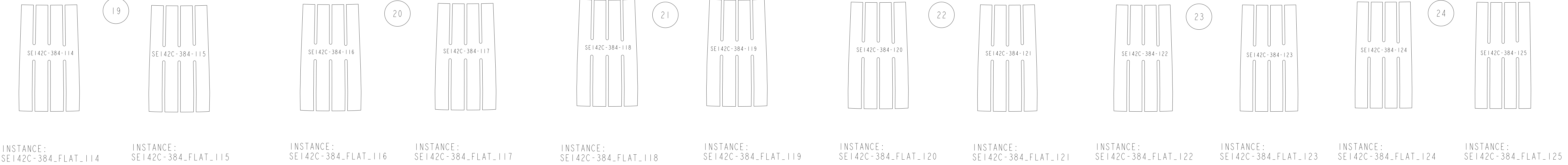
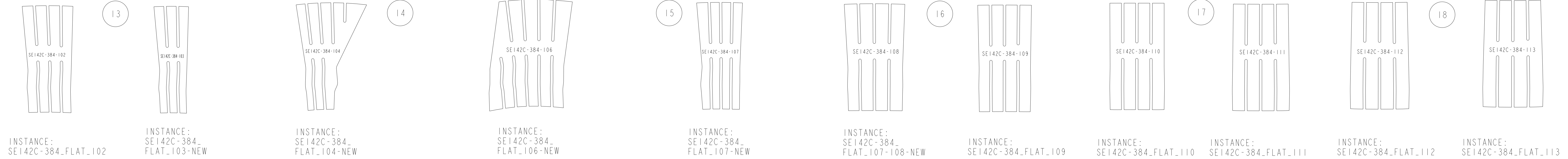

SCALE ALL VIEWS: 1.00

Oak Ridge National Laboratory  
managed for the DEPARTMENT OF ENERGY under  
U.S. GOVERNMENT contract DE-AC05-00OR22725  
UT-BATTELLE, LLC, Oak Ridge, Tennessee  
PROJECT NAME

**UT-BATTELLE**

**NATIONAL COMPACT STELLARATOR EXPERIMENT**  
MODULAR COIL TYPE - C  
SIDE - A LOWER CLADDING  
FLAT PATTERN LAYOUT

VERSION NO. 3+	PLANT X-10	BLDG 5700	FL 3	SHT 2	OF 5	TYPE S	CLASS U
RELEASE LEVEL Fabrication		SE142C-384			REV 1		

SE142C-384

8

7

6

5

4

3

2

1

NEXT ASS'Y:

FINAL ASS'Y:

H

H

G

G

F

F

E

E

D

D

C

C

B

B

A

A

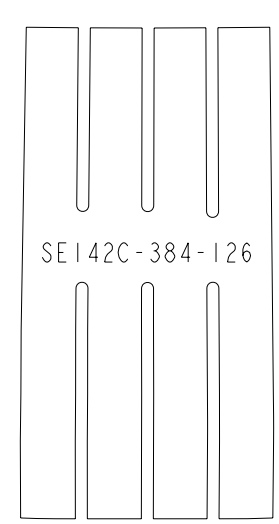

25

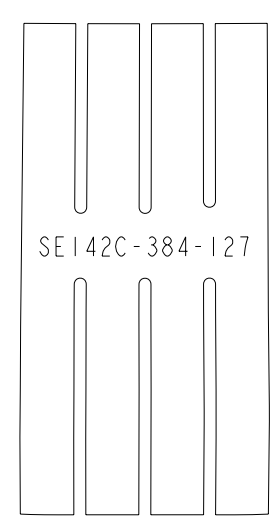

26

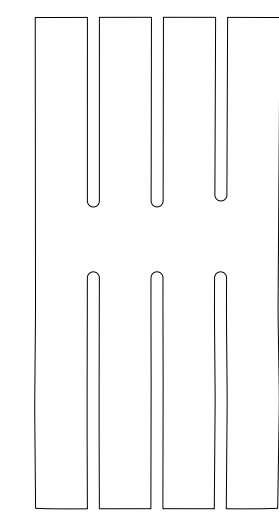
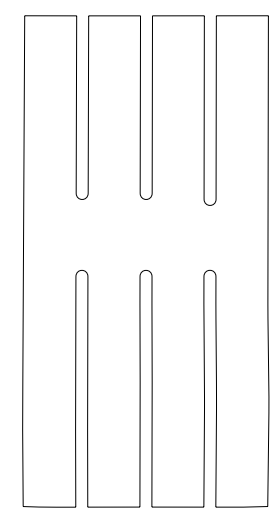

27

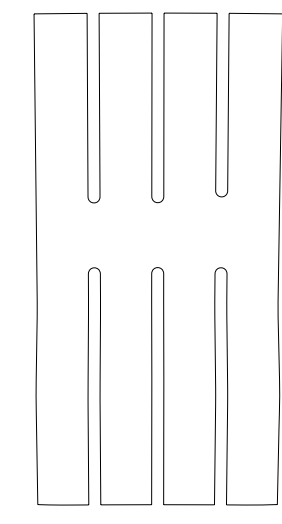
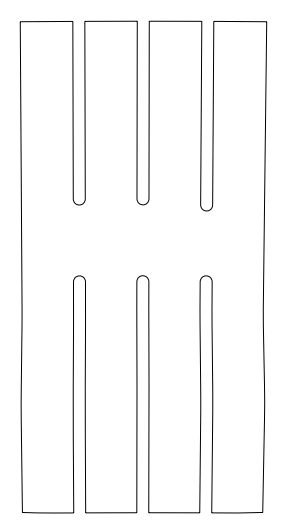

28

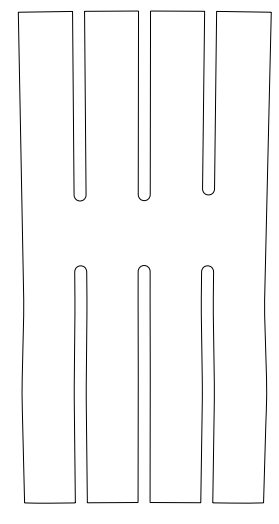
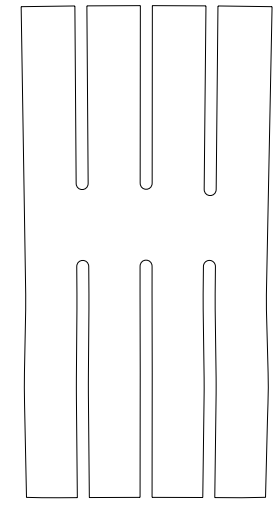

29

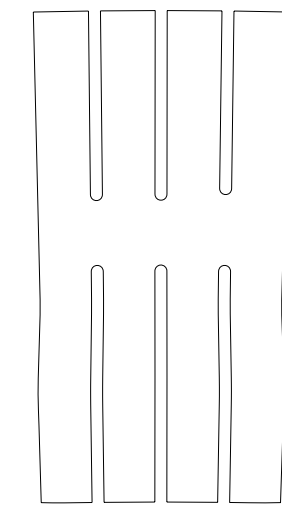
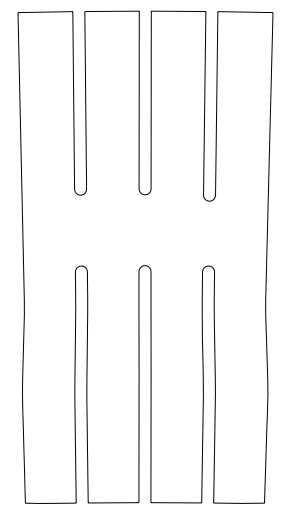

30

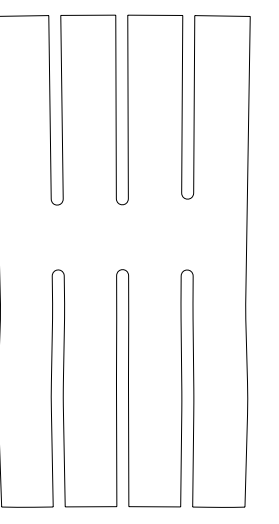
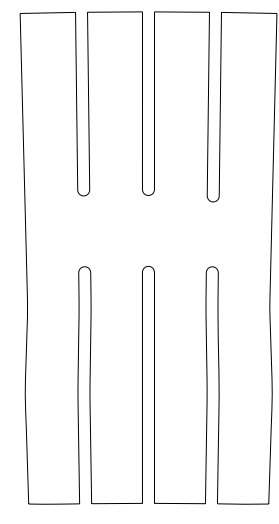

INSTANCE:  
SE142C-384\_FLAT\_126

INSTANCE:  
SE142C-384\_FLAT\_127

INSTANCE:  
SE142C-384\_FLAT\_128

INSTANCE:  
SE142C-384\_FLAT\_129

INSTANCE:  
SE142C-384\_FLAT\_130

INSTANCE:  
SE142C-384\_FLAT\_131

INSTANCE:  
SE142C-384\_FLAT\_132

INSTANCE:  
SE142C-384\_FLAT\_133

INSTANCE:  
SE142C-384\_FLAT\_134

INSTANCE:  
SE142C-384\_FLAT\_135

INSTANCE:  
SE142C-384\_FLAT\_136

INSTANCE:  
SE142C-384\_FLAT\_137

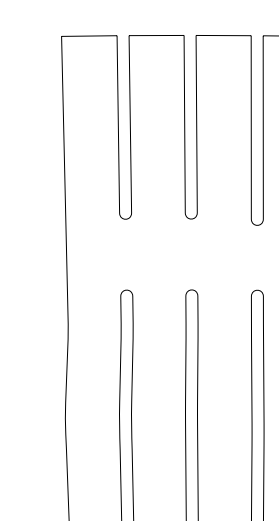

31

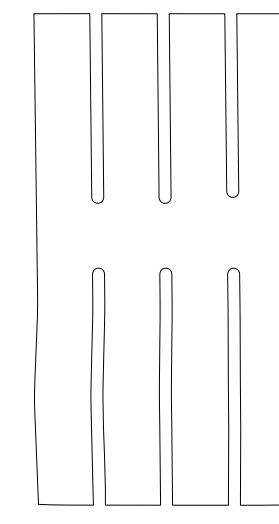

32

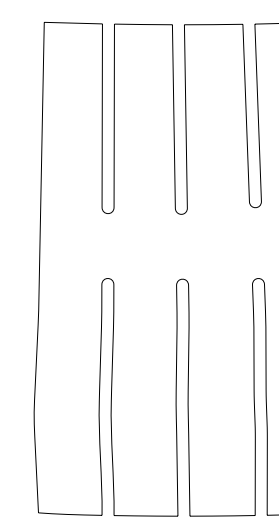
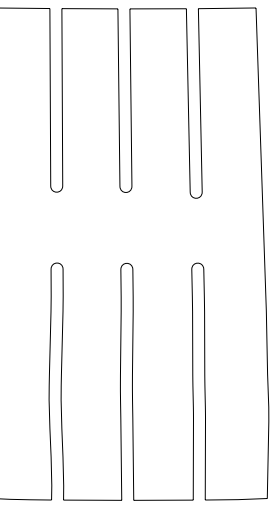

33

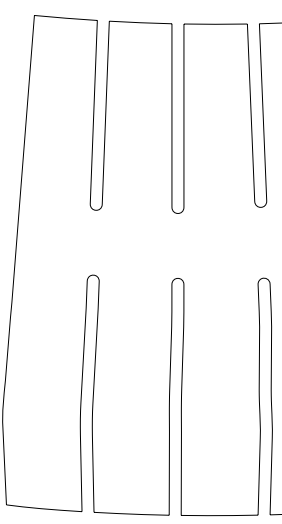
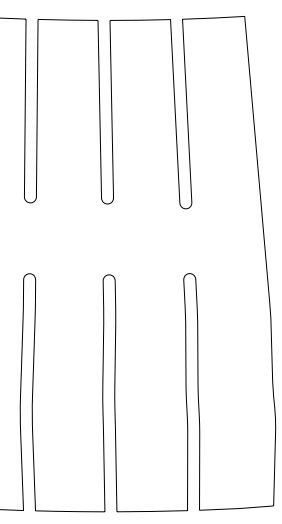

34

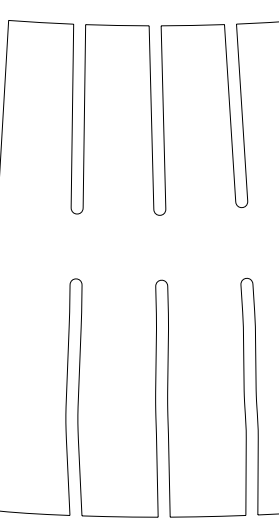
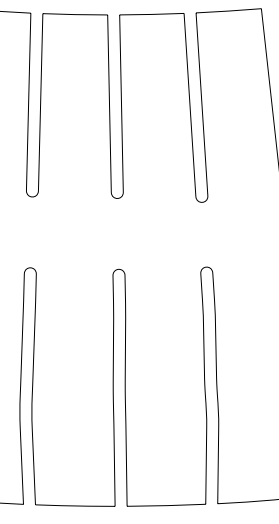

35

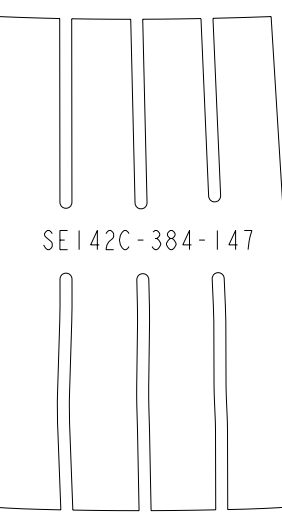
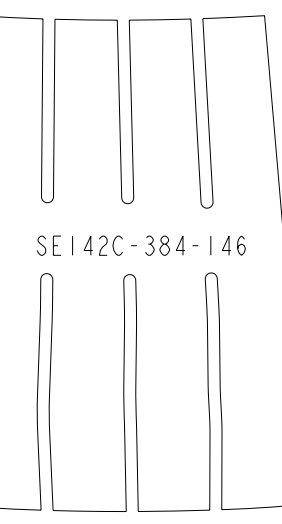

36

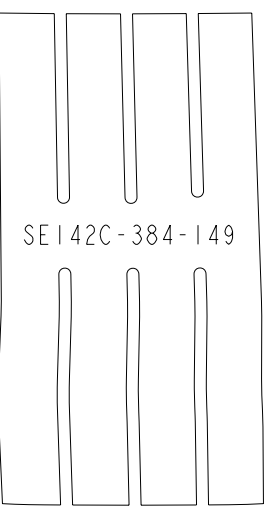
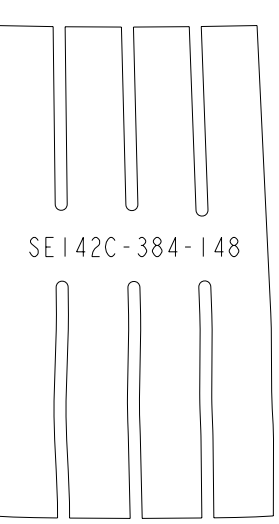

INSTANCE:  
SE142C-384\_FLAT\_138

INSTANCE:  
SE142C-384\_FLAT\_139

INSTANCE:  
SE142C-384\_FLAT\_140

INSTANCE:  
SE142C-384\_FLAT\_141

INSTANCE:  
SE142C-384\_FLAT\_142

INSTANCE:  
SE142C-384\_FLAT\_143

INSTANCE:  
SE142C-384\_FLAT\_144

INSTANCE:  
SE142C-384\_FLAT\_145

INSTANCE:  
SE142C-384\_FLAT\_146

INSTANCE:  
SE142C-384\_FLAT\_147

INSTANCE:  
SE142C-384\_FLAT\_148

INSTANCE:  
SE142C-384\_FLAT\_149

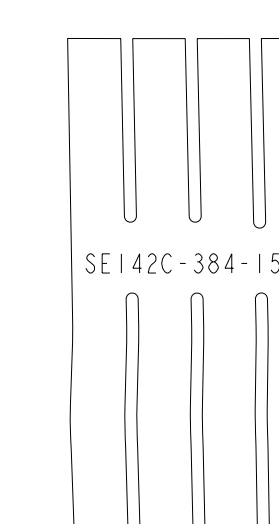

37

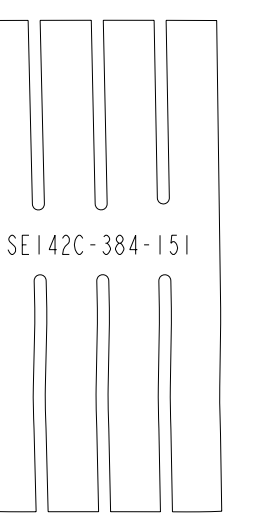

38

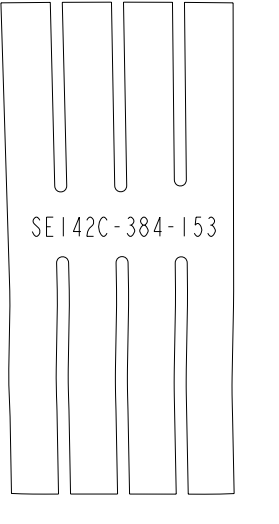
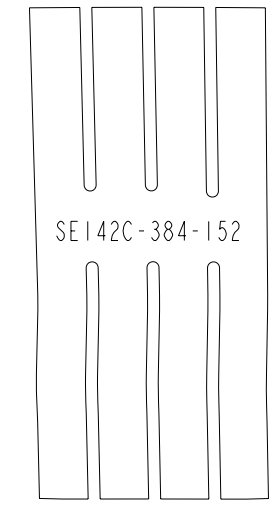

39

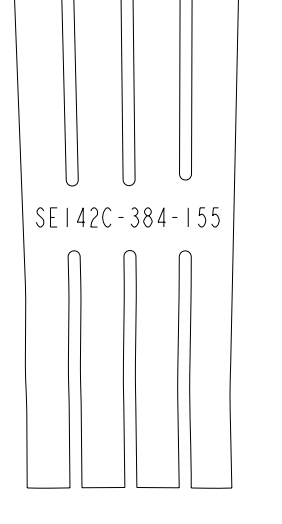
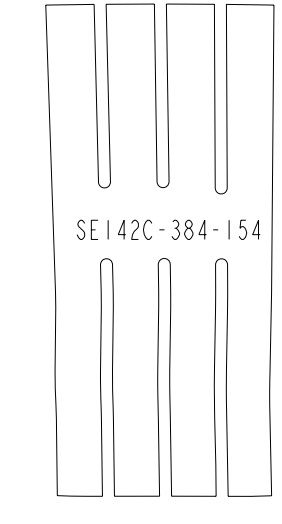

40

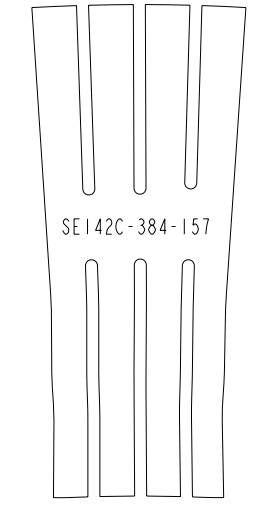
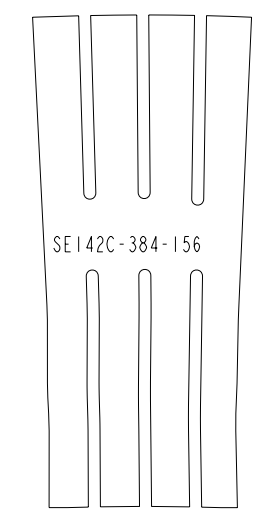

41

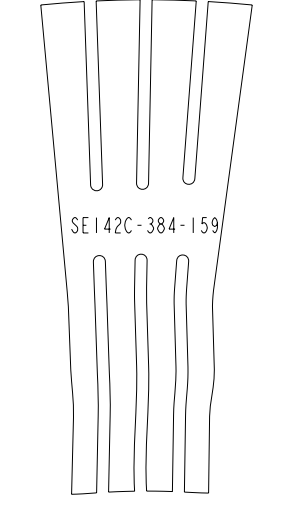
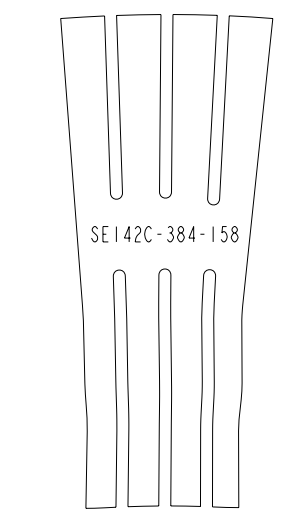

42

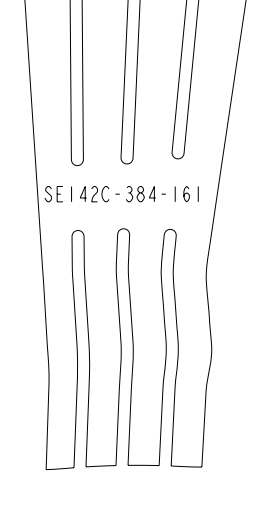
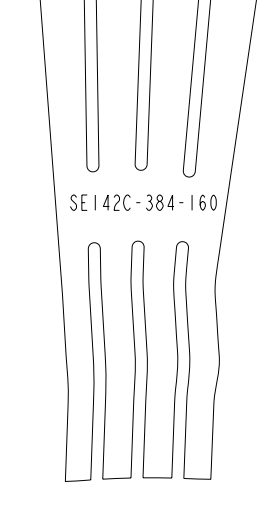

INSTANCE:  
SE142C-384\_FLAT\_150

INSTANCE:  
SE142C-384\_FLAT\_151

INSTANCE:  
SE142C-384\_FLAT\_152

INSTANCE:  
SE142C-384\_FLAT\_153

INSTANCE:  
SE142C-384\_FLAT\_154

INSTANCE:  
SE142C-384\_FLAT\_155

INSTANCE:  
SE142C-384\_FLAT\_156

INSTANCE:  
SE142C-384\_FLAT\_157

INSTANCE:  
SE142C-384\_FLAT\_158

INSTANCE:  
SE142C-384\_FLAT\_159

INSTANCE:  
SE142C-384\_FLAT\_160

INSTANCE:  
SE142C-384\_FLAT\_161

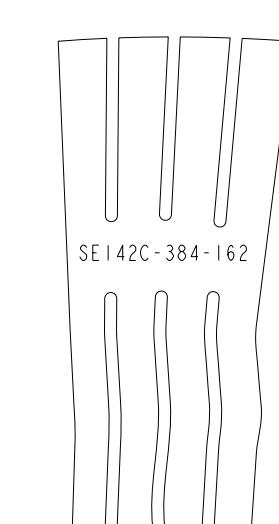

43

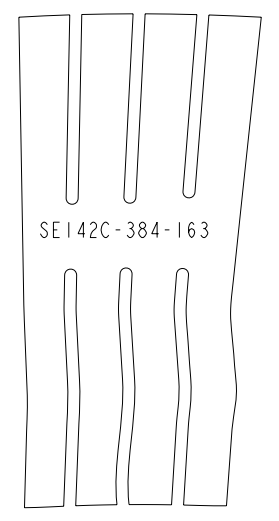

44

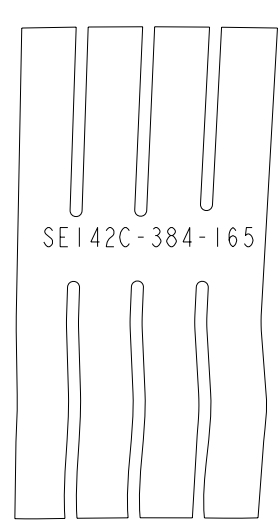
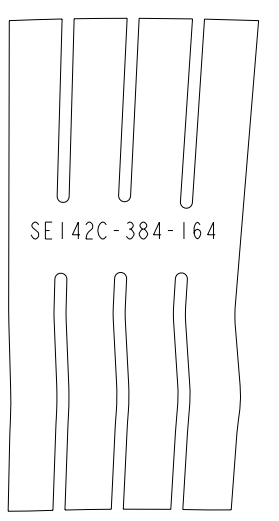

45

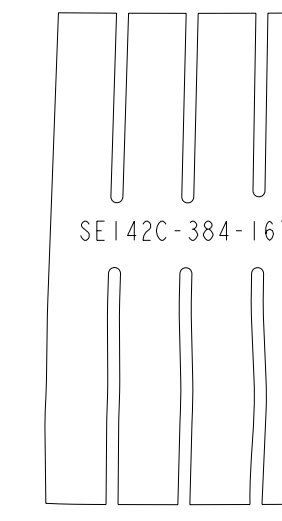
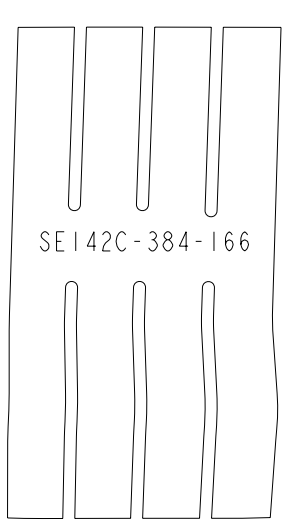

46

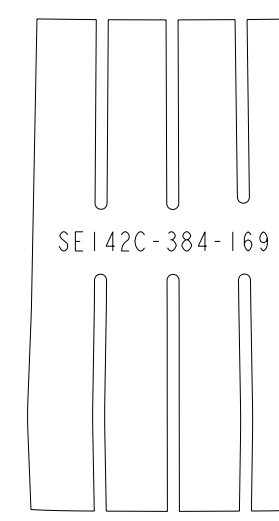
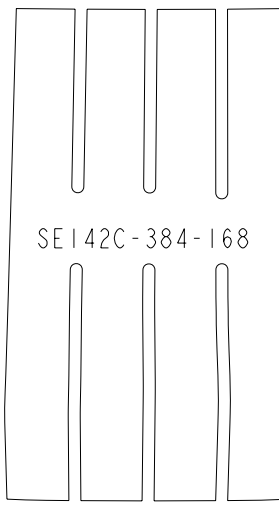

47

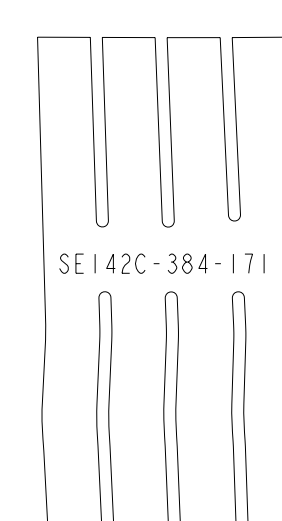
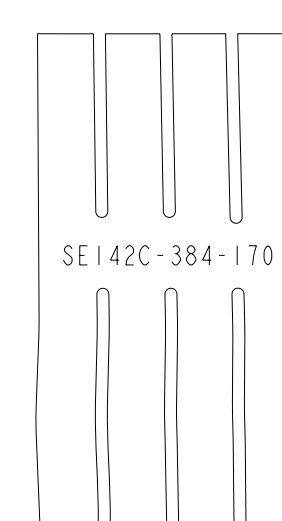

48

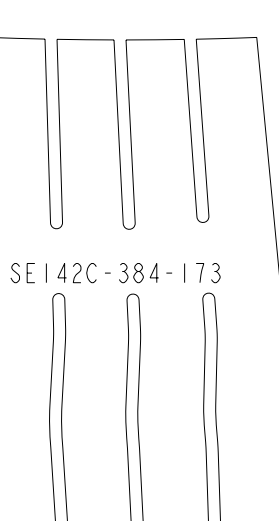
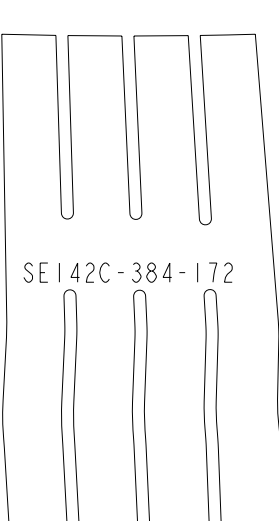

INSTANCE:  
SE142C-384\_FLAT\_162

INSTANCE:  
SE142C-384\_FLAT\_163

INSTANCE:  
SE142C-384\_FLAT\_164

INSTANCE:  
SE142C-384\_FLAT\_165

INSTANCE:  
SE142C-384\_FLAT\_166

INSTANCE:  
SE142C-384\_FLAT\_167

INSTANCE:  
SE142C-384\_FLAT\_168

INSTANCE:  
SE142C-384\_FLAT\_169

INSTANCE:  
SE142C-384\_FLAT\_170

INSTANCE:  
SE142C-384\_FLAT\_171

INSTANCE:  
SE142C-384\_FLAT\_172

INSTANCE:  
SE142C-384\_FLAT\_173

SCALE ALL VIEWS: 1.00

Oak Ridge National Laboratory  
managed for the DEPARTMENT OF ENERGY under  
U.S. GOVERNMENT CONTRACT DE-AC05-00OR22725  
UT-BATTELLE, LLC, Oak Ridge, Tennessee  
PROJECT NAME

**UT-BATTELLE**

**NATIONAL COMPACT STELLARATOR EXPERIMENT**

**MODULAR COIL TYPE - C**

**SIDE - A LOWER CLADDING**

**FLAT PATTERN LAYOUT**

VERSION NO. 3+	PLANT X-10	BLDG 5700	FL 3	SHT OF 3	TYPE S	CLASS U
RELEASE LEVEL Fabrication		SE142C-384			REV 1	

8

7

6

5

4

3

2

1

SE142C-384

8

7

6

5

4

3

2

1

NEXT ASS'Y:

FINAL ASS'Y:

H

H

G

G

F

F

E

E

D

D

C

C

B

B

A

A

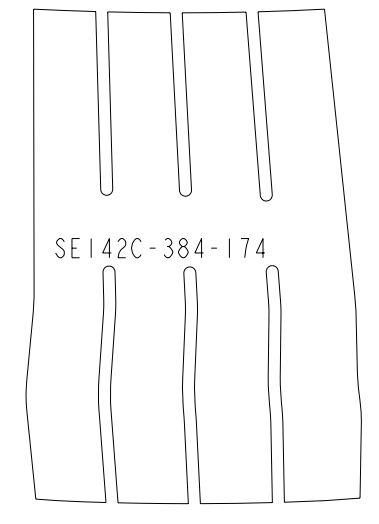

49

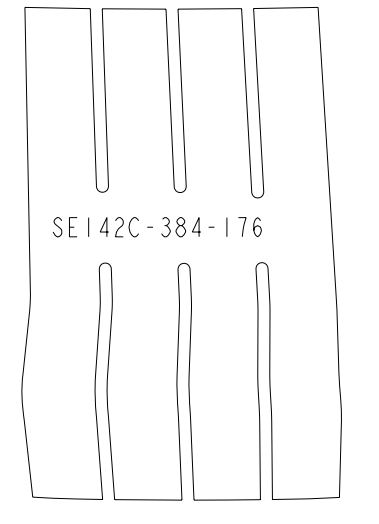
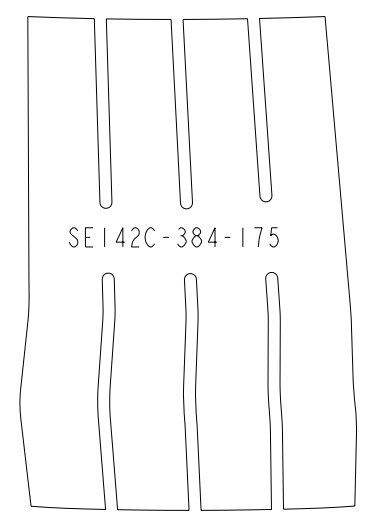

50

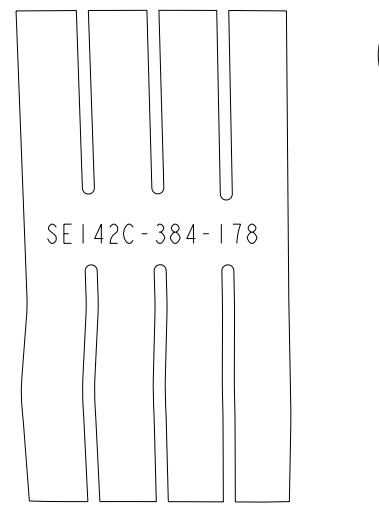
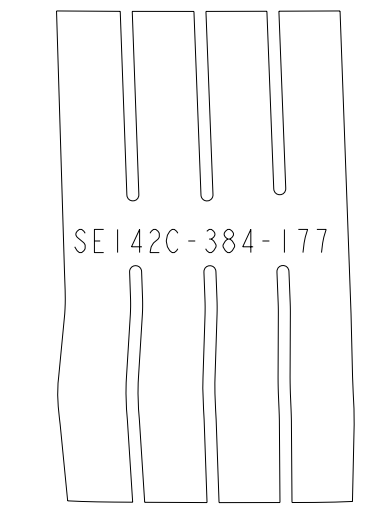

51

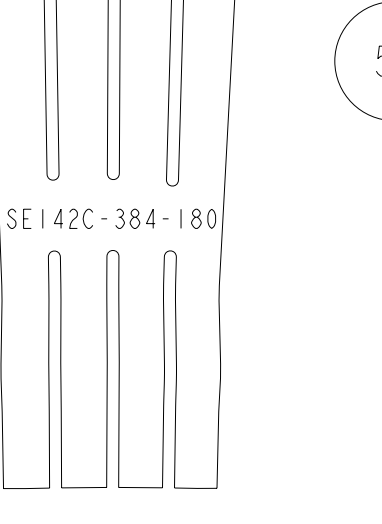
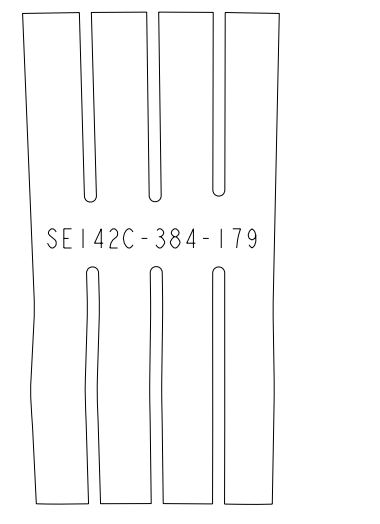

52

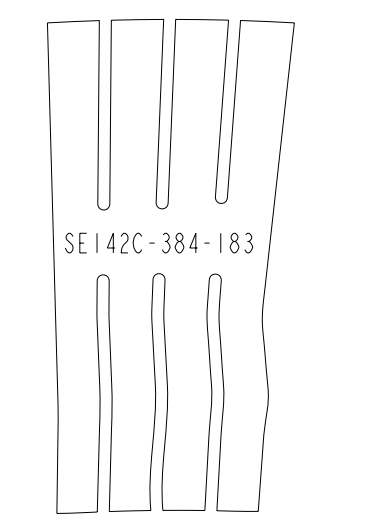
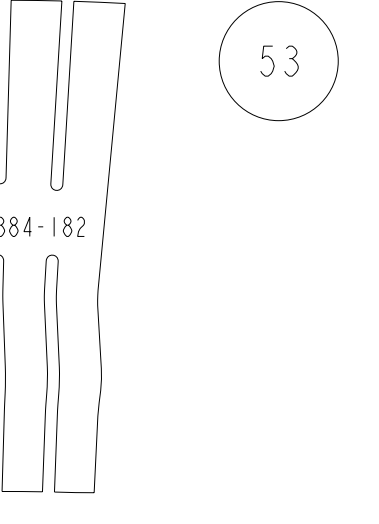
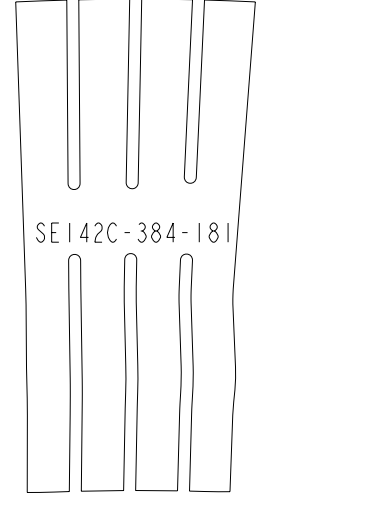

53

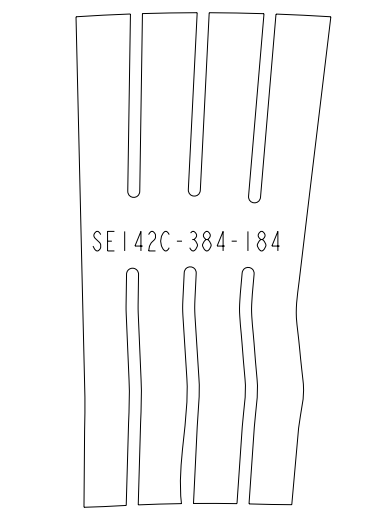

54

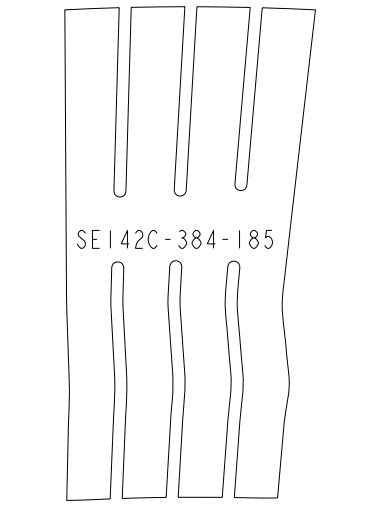

INSTANCE:  
SE142C-384\_FLAT\_174

INSTANCE:  
SE142C-384\_FLAT\_175

INSTANCE:  
SE142C-384\_FLAT\_176

INSTANCE:  
SE142C-384\_FLAT\_177

INSTANCE:  
SE142C-384\_FLAT\_178

INSTANCE:  
SE142C-384\_FLAT\_179

INSTANCE:  
SE142C-384\_FLAT\_180

INSTANCE:  
SE142C-384\_FLAT\_181

INSTANCE:  
SE142C-384\_FLAT\_182

INSTANCE:  
SE142C-384\_FLAT\_183

INSTANCE:  
SE142C-384\_FLAT\_184

INSTANCE:  
SE142C-384\_FLAT\_185

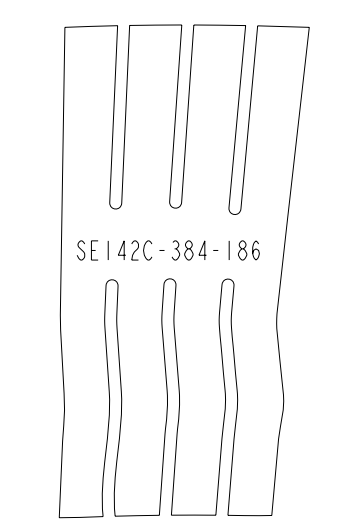

55

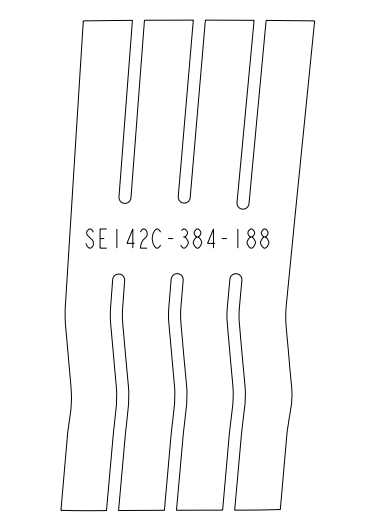
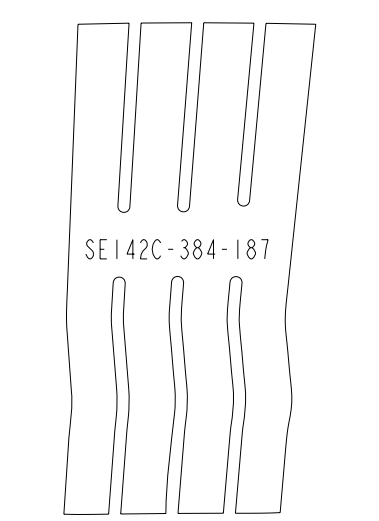

56

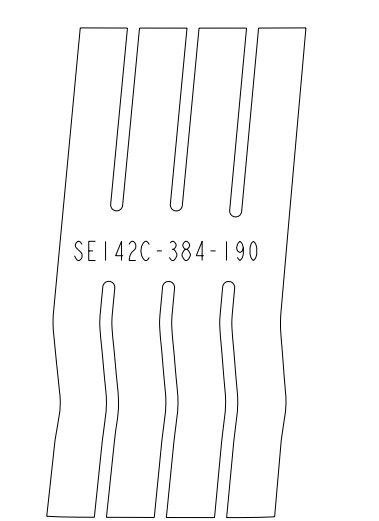
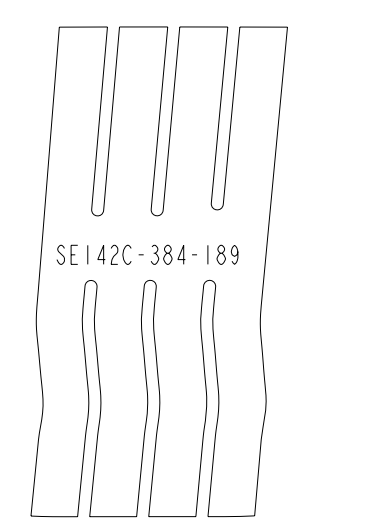

57

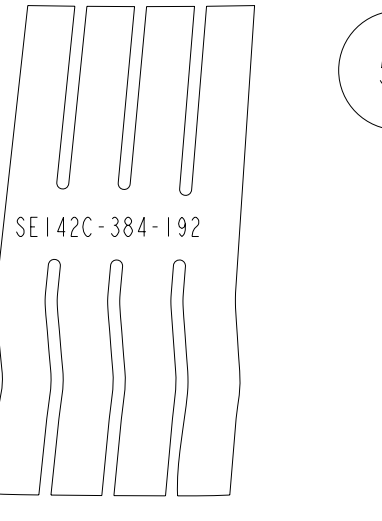
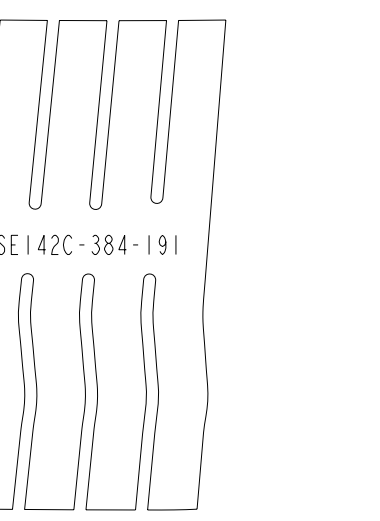

58

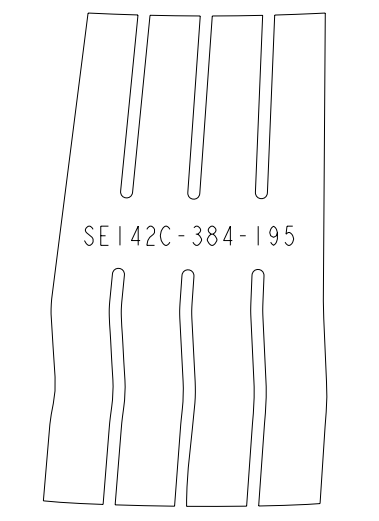
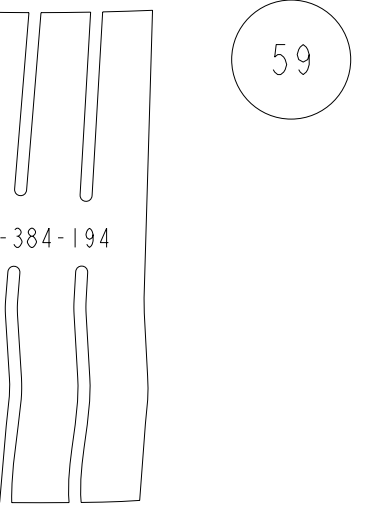
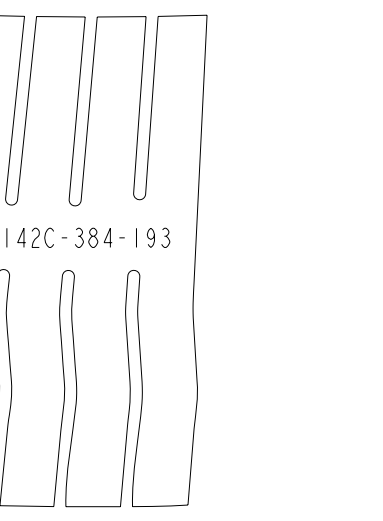

59

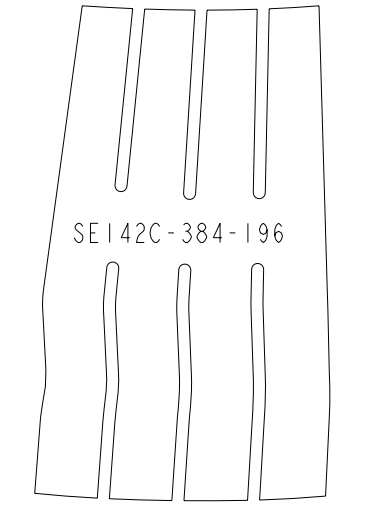

60

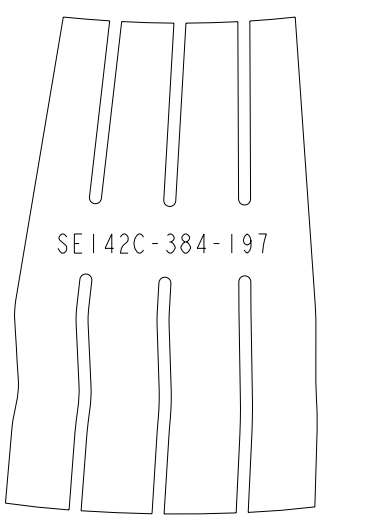

INSTANCE:  
SE142C-384\_FLAT\_186

INSTANCE:  
SE142C-384\_FLAT\_187

INSTANCE:  
SE142C-384\_FLAT\_188

INSTANCE:  
SE142C-384\_FLAT\_189

INSTANCE:  
SE142C-384\_FLAT\_190

INSTANCE:  
SE142C-384\_FLAT\_191

INSTANCE:  
SE142C-384\_FLAT\_192

INSTANCE:  
SE142C-384\_FLAT\_193

INSTANCE:  
SE142C-384\_FLAT\_194

INSTANCE:  
SE142C-384\_FLAT\_195\_NEW

INSTANCE:  
SE142C-384\_FLAT\_196

INSTANCE:  
SE142C-384\_FLAT\_197

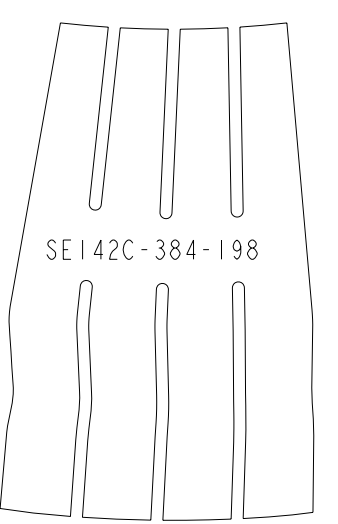

61

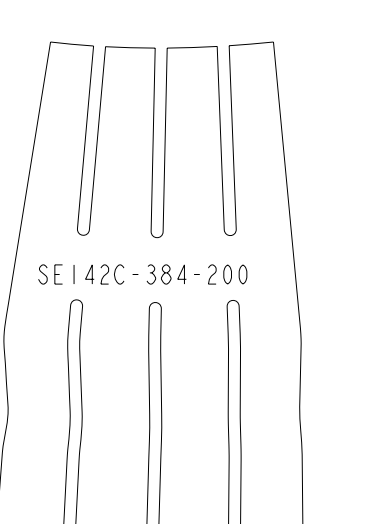
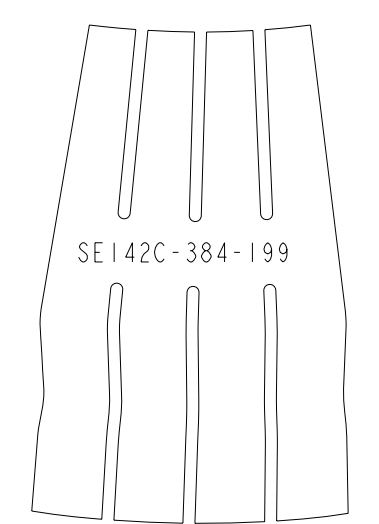

62

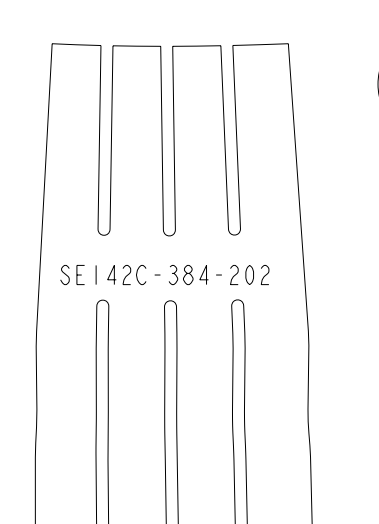
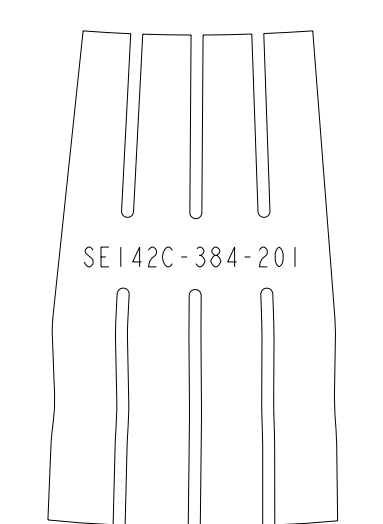

63

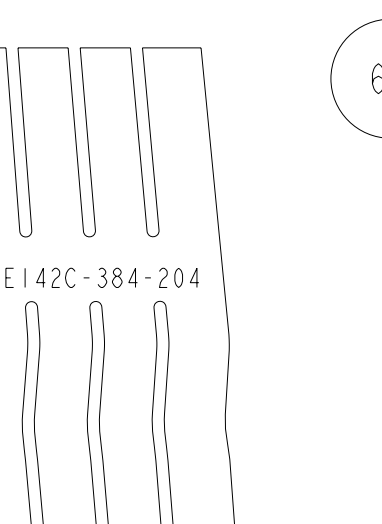
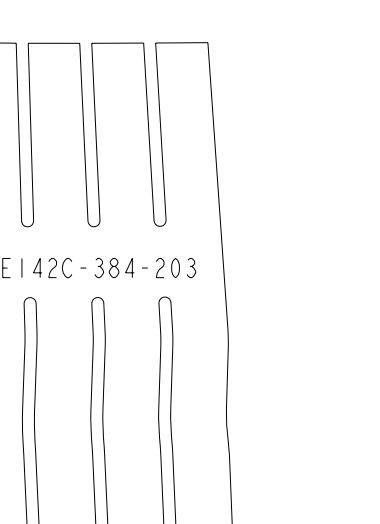

64

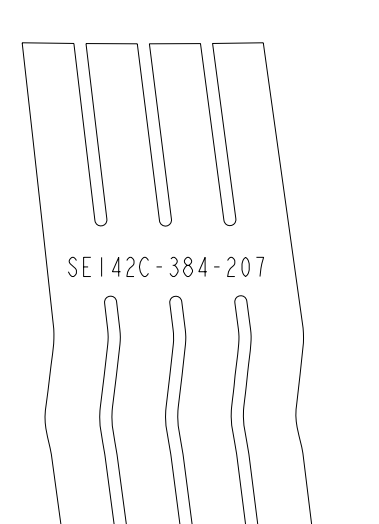
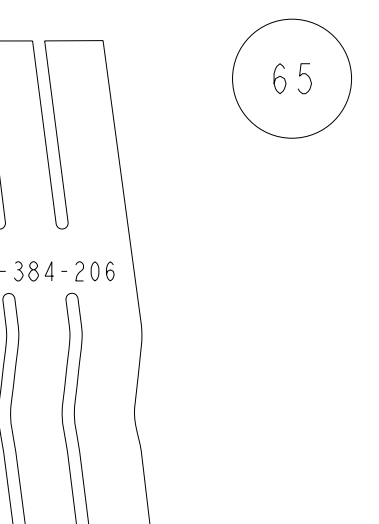
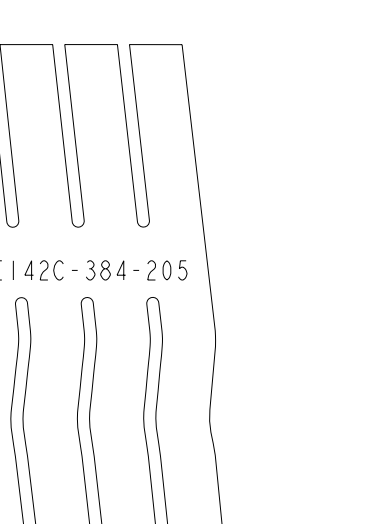

65

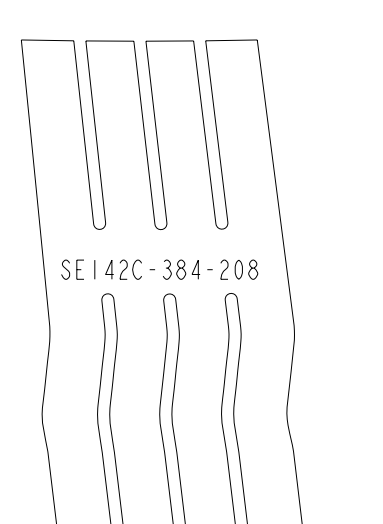

66

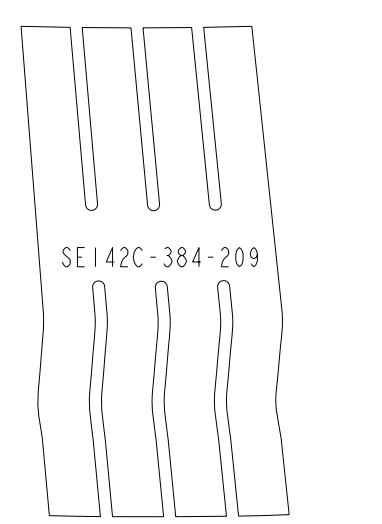

INSTANCE:  
SE142C-384\_FLAT\_198  
291\_NO\_CLAMP

INSTANCE:  
SE142C-384\_FLAT\_199  
292\_NO\_CLAMP

INSTANCE:  
SE142C-384\_FLAT\_200

INSTANCE:  
SE142C-384\_FLAT\_201

INSTANCE:  
SE142C-384\_FLAT\_202

INSTANCE:  
SE142C-384\_FLAT\_203

INSTANCE:  
SE142C-384\_FLAT\_204

INSTANCE:  
SE142C-384\_FLAT\_205

INSTANCE:  
SE142C-384\_FLAT\_206

INSTANCE:  
SE142C-384\_FLAT\_207

INSTANCE:  
SE142C-384\_FLAT\_208

INSTANCE:  
SE142C-384\_FLAT\_209

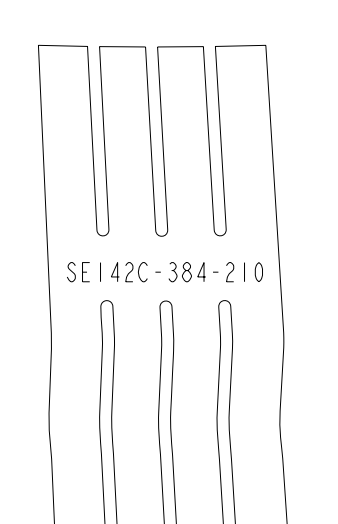

67

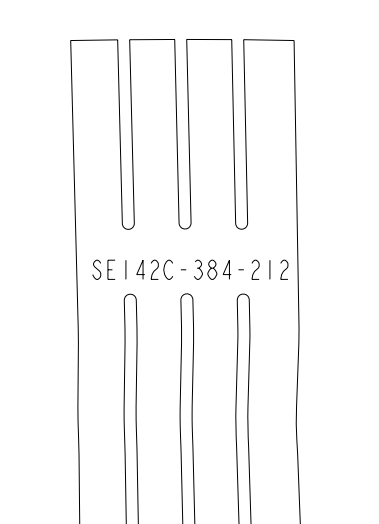
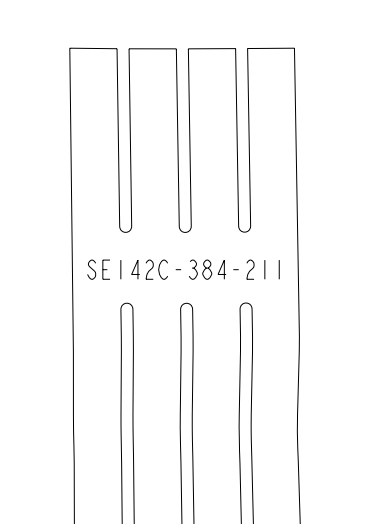

68

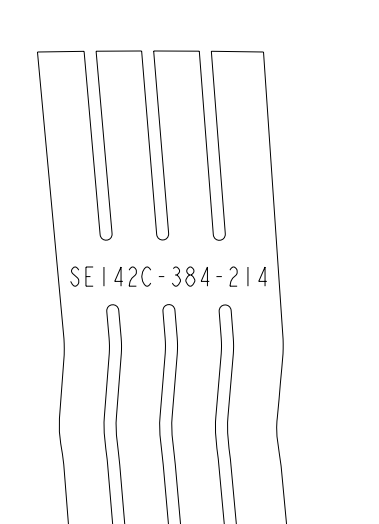
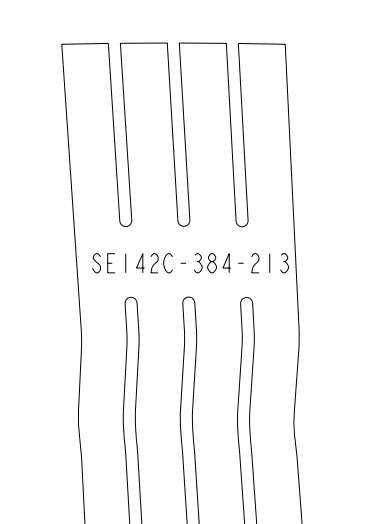

69

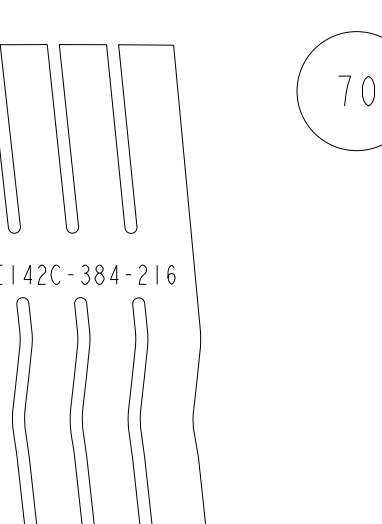
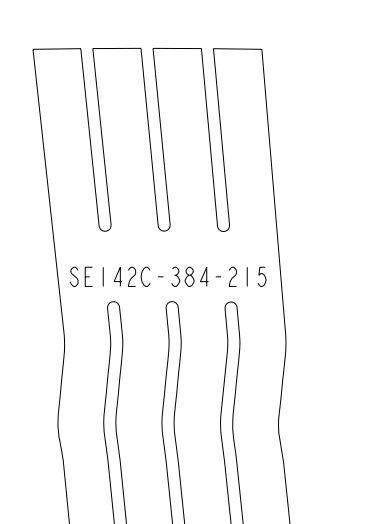

70

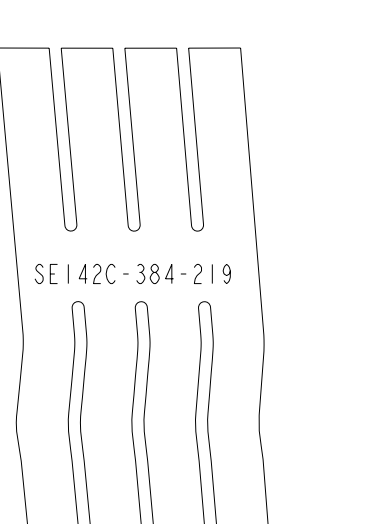
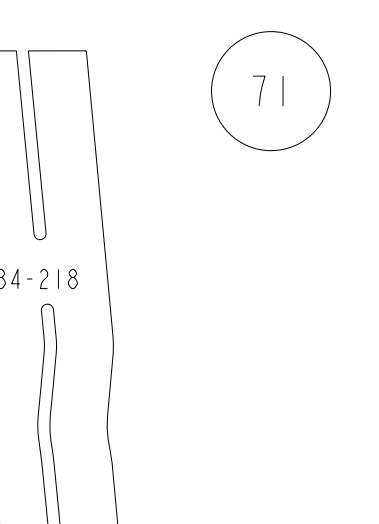
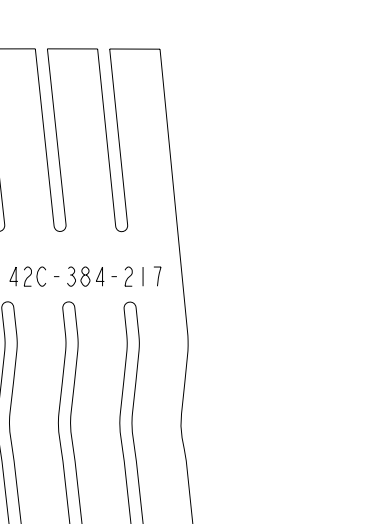

71

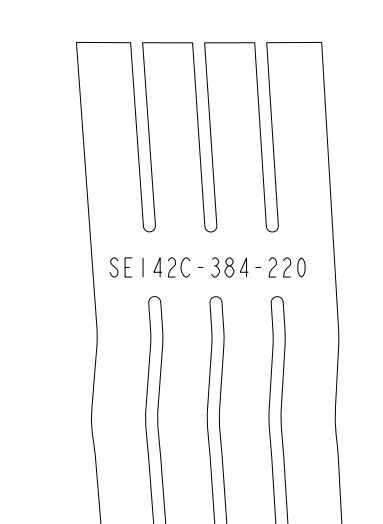

72

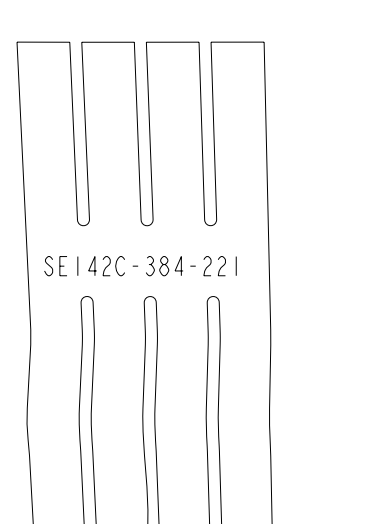

INSTANCE:  
SE142C-384\_FLAT\_210

INSTANCE:  
SE142C-384\_FLAT\_211

INSTANCE:  
SE142C-384\_FLAT\_212

INSTANCE:  
SE142C-384\_FLAT\_213

INSTANCE:  
SE142C-384\_FLAT\_214

INSTANCE:  
SE142C-384\_FLAT\_215

INSTANCE:  
SE142C-384\_FLAT\_216

INSTANCE:  
SE142C-384\_FLAT\_217

INSTANCE:  
SE142C-384\_FLAT\_218

INSTANCE:  
SE142C-384\_FLAT\_219

INSTANCE:  
SE142C-384\_FLAT\_220

INSTANCE:  
SE142C-384\_FLAT\_221

SCALE ALL VIEWS: 1.00

Oak Ridge National Laboratory  
managed for the DEPARTMENT OF ENERGY under  
U.S. GOVERNMENT CONTRACT DE-AC05-00OR22725  
UT-BATTELLE, LLC, Oak Ridge, Tennessee

**UT-BATTELLE**

**NATIONAL COMPACT STELLARATOR EXPERIMENT**

**MODULAR COIL TYPE - C**

**SIDE - A LOWER CLADDING**

**FLAT PATTERN LAYOUT**

VERSION NO.	PLANT	BLDG	FL	SHT	OF	TYPE	CLASS
3+	X-10	5700	3	4	5	S	U
RELEASE LEVEL		SE142C-384		REV			
Fabrication				I			

8

7

6

5

4

3

2

1

SE142C-384

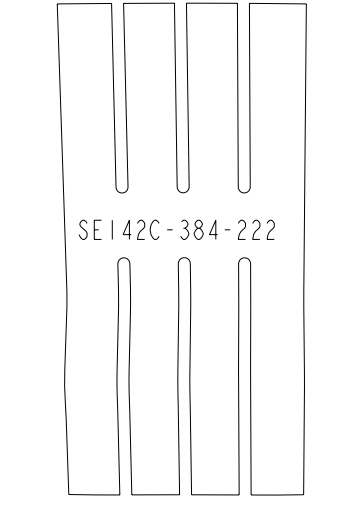
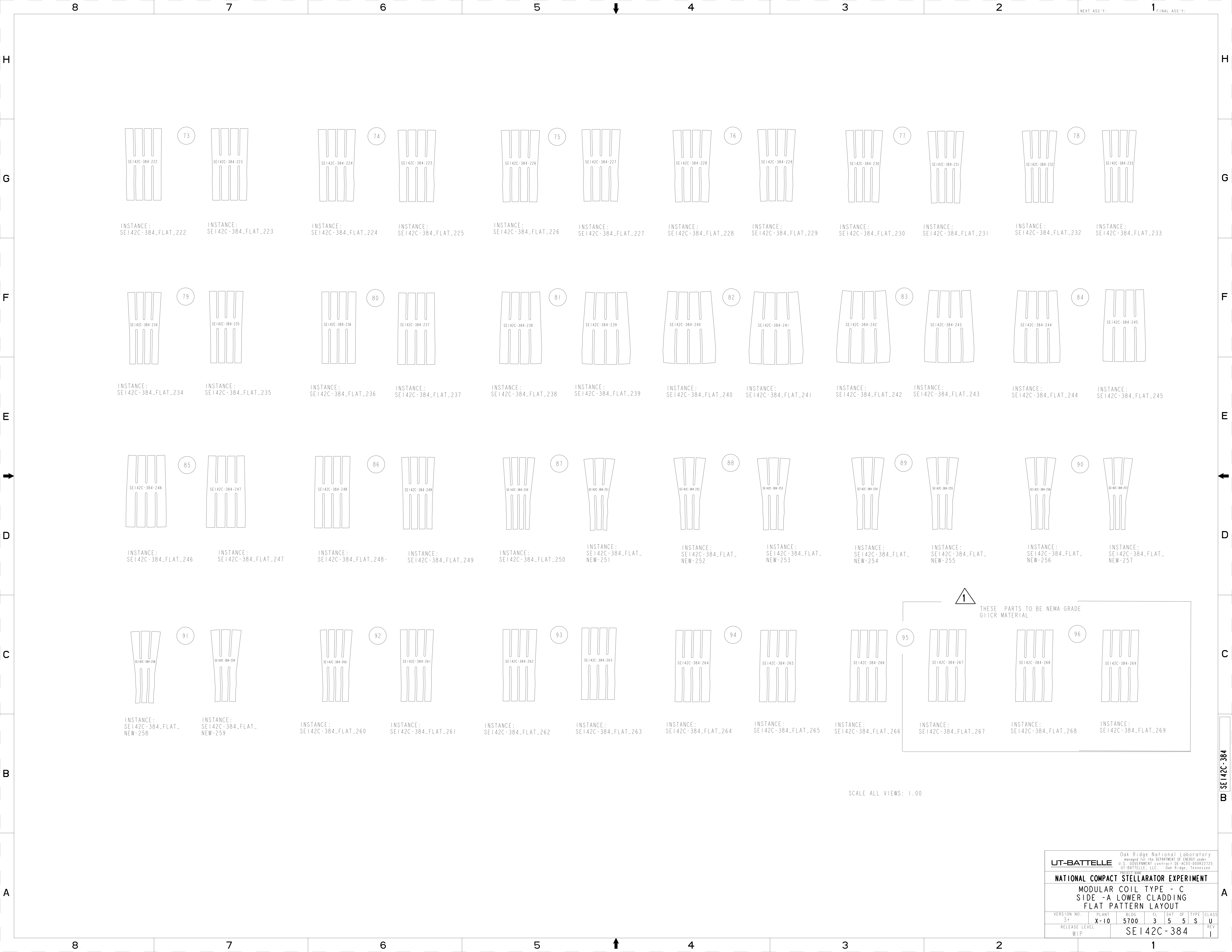

73

INSTANCE:  
SE142C-384\_FLAT\_222

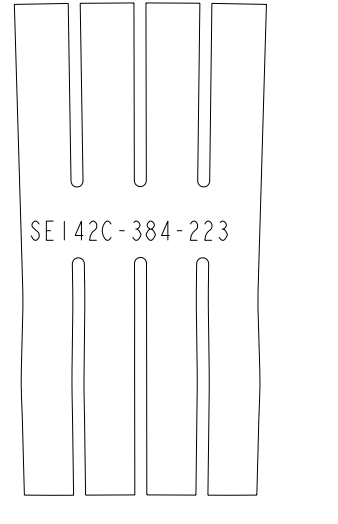

74

INSTANCE:  
SE142C-384\_FLAT\_223

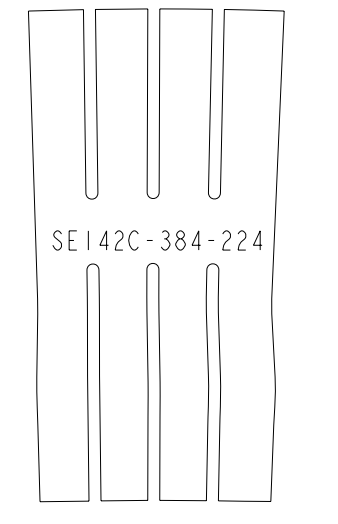

75

INSTANCE:  
SE142C-384\_FLAT\_224

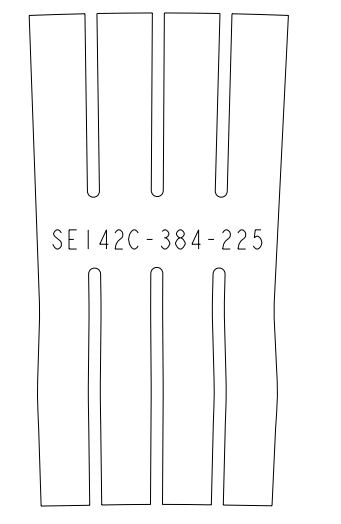

76

INSTANCE:  
SE142C-384\_FLAT\_225

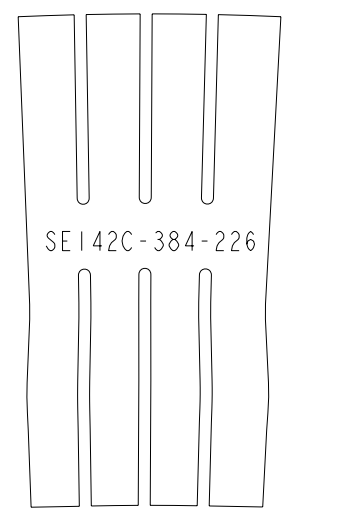

77

INSTANCE:  
SE142C-384\_FLAT\_226

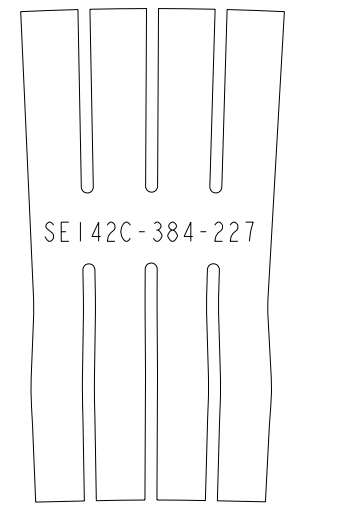

78

INSTANCE:  
SE142C-384\_FLAT\_227

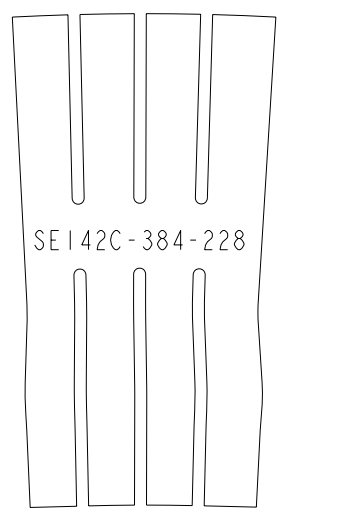

79

INSTANCE:  
SE142C-384\_FLAT\_228

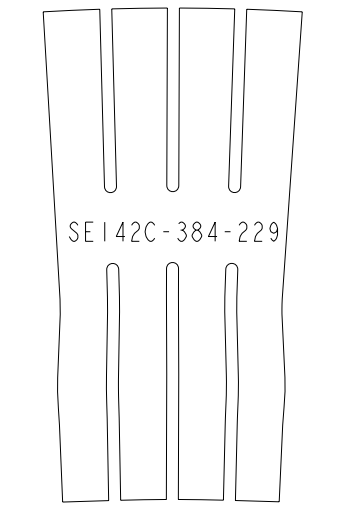

80

INSTANCE:  
SE142C-384\_FLAT\_229

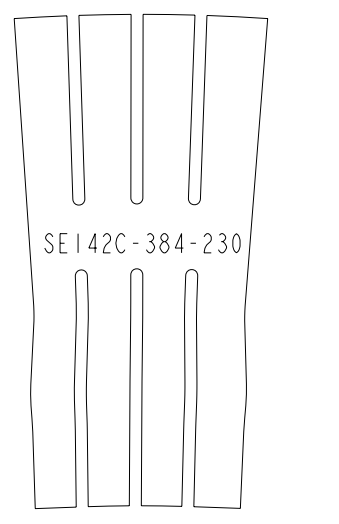

81

INSTANCE:  
SE142C-384\_FLAT\_230

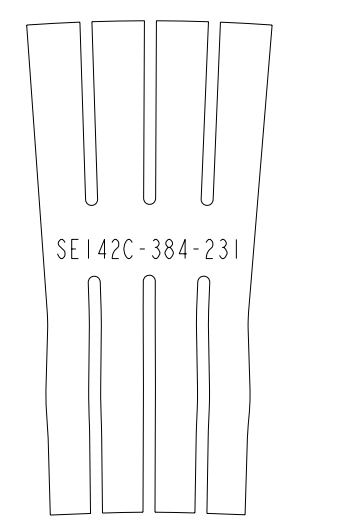

82

INSTANCE:  
SE142C-384\_FLAT\_231

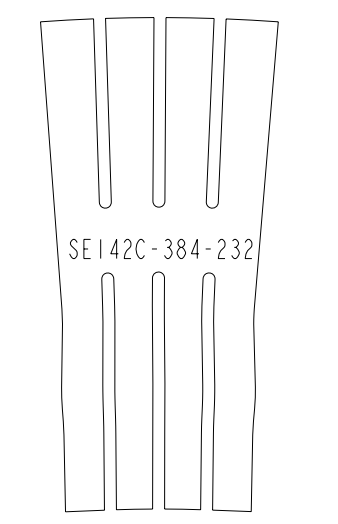

83

INSTANCE:  
SE142C-384\_FLAT\_232

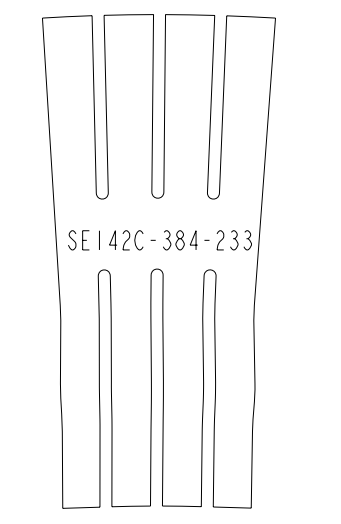

84

INSTANCE:  
SE142C-384\_FLAT\_233

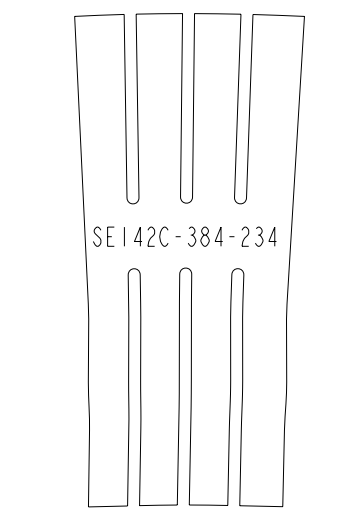

85

INSTANCE:  
SE142C-384\_FLAT\_234

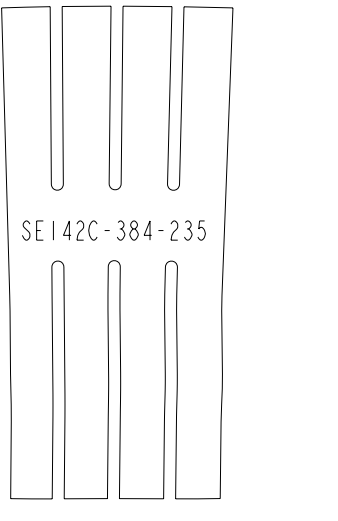

86

INSTANCE:  
SE142C-384\_FLAT\_235

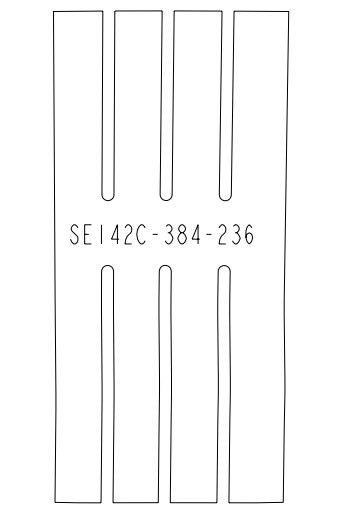

87

INSTANCE:  
SE142C-384\_FLAT\_236

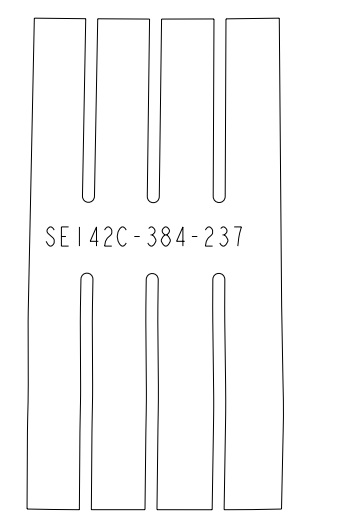

88

INSTANCE:  
SE142C-384\_FLAT\_237

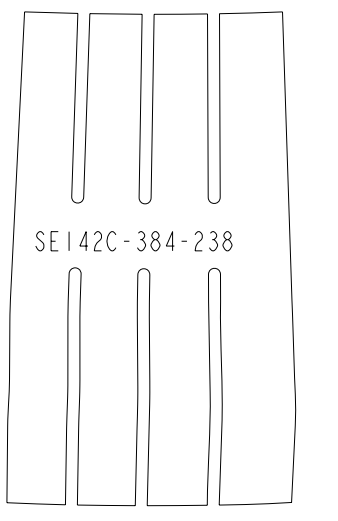

89

INSTANCE:  
SE142C-384\_FLAT\_238

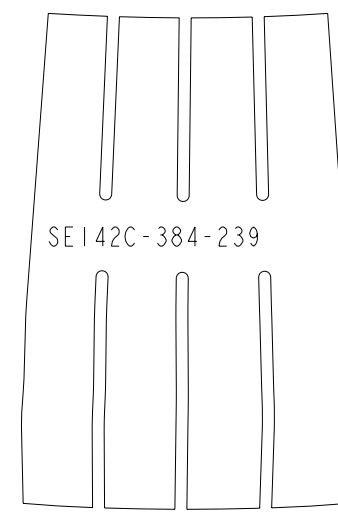

90

INSTANCE:  
SE142C-384\_FLAT\_239

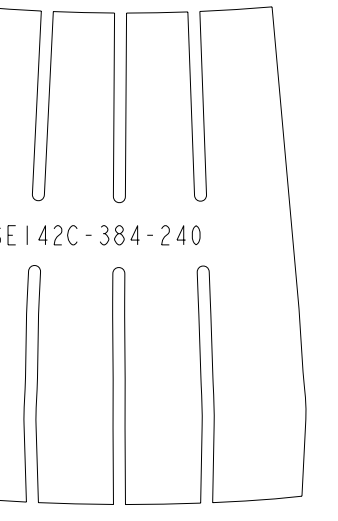

91

INSTANCE:  
SE142C-384\_FLAT\_240

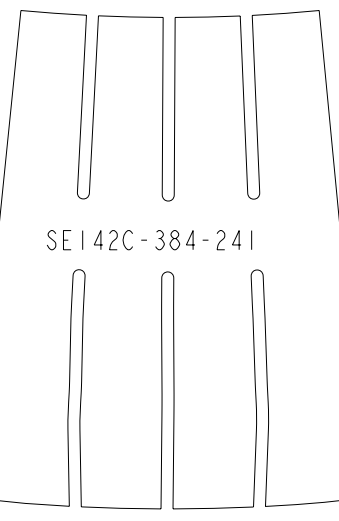

92

INSTANCE:  
SE142C-384\_FLAT\_241

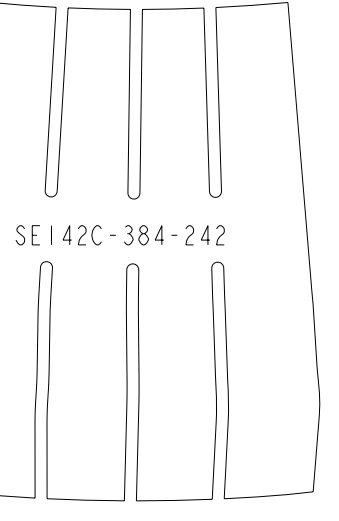

93

INSTANCE:  
SE142C-384\_FLAT\_242

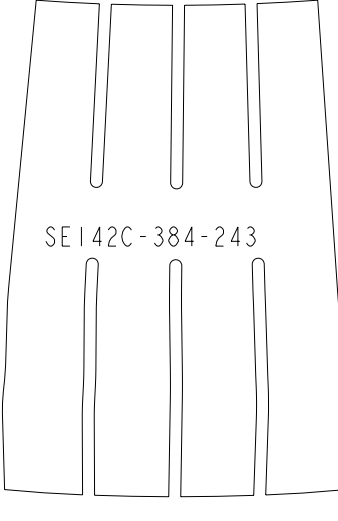

94

INSTANCE:  
SE142C-384\_FLAT\_243

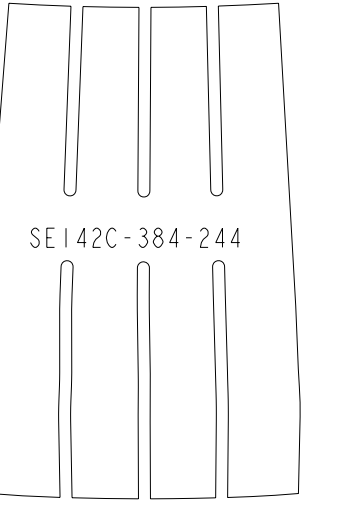

95

INSTANCE:  
SE142C-384\_FLAT\_244

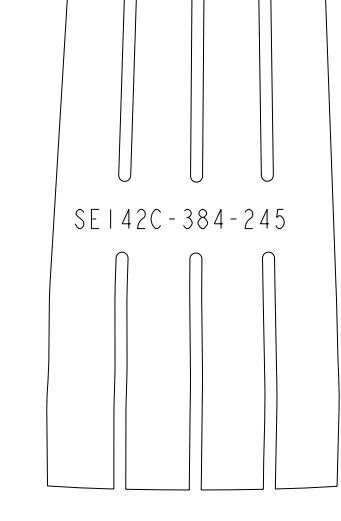

96

INSTANCE:  
SE142C-384\_FLAT\_245

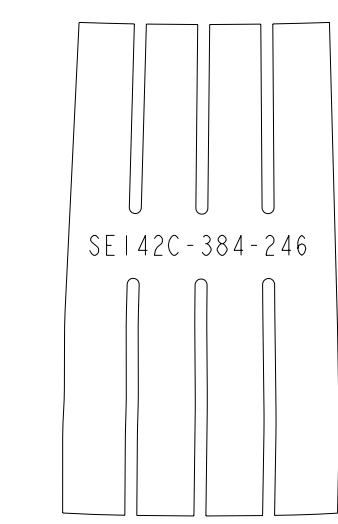

97

INSTANCE:  
SE142C-384\_FLAT\_246

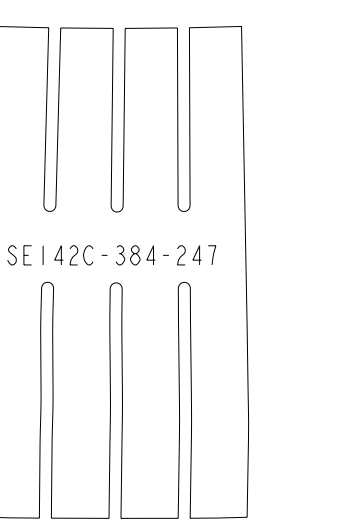

98

INSTANCE:  
SE142C-384\_FLAT\_247

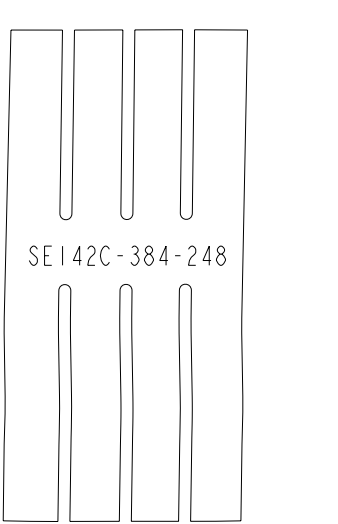

99

INSTANCE:  
SE142C-384\_FLAT\_248

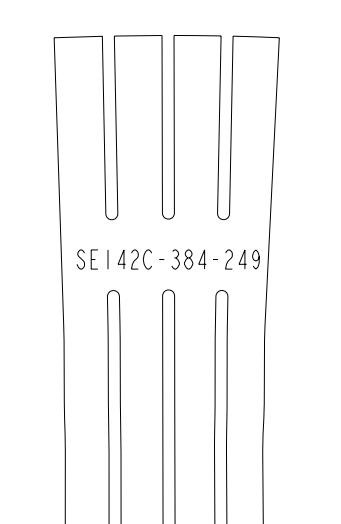

100

INSTANCE:  
SE142C-384\_FLAT\_249

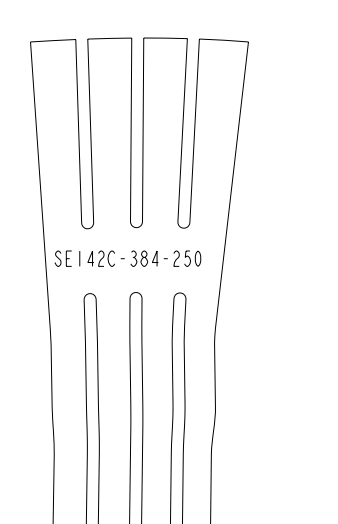

101

INSTANCE:  
SE142C-384\_FLAT\_250

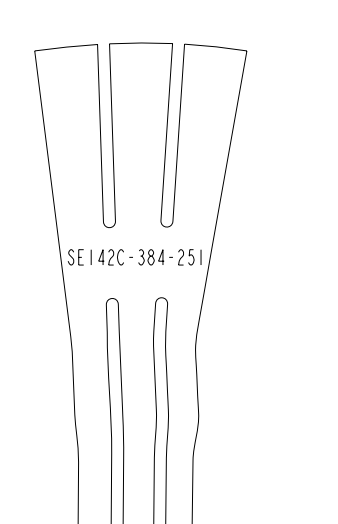

102

INSTANCE:  
SE142C-384\_FLAT\_NEW-251

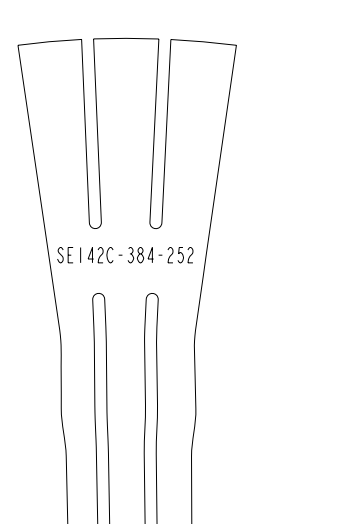

103

INSTANCE:  
SE142C-384\_FLAT\_NEW-252

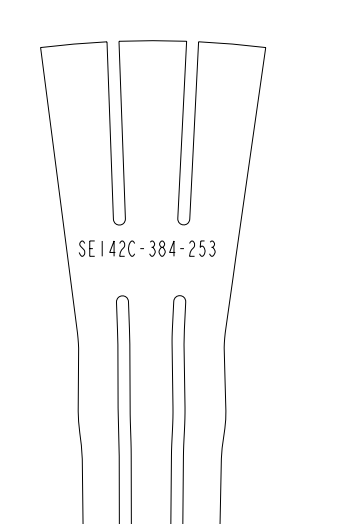

104

INSTANCE:  
SE142C-384\_FLAT\_NEW-253

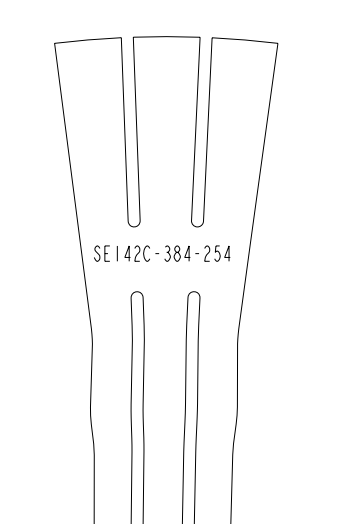

105

INSTANCE:  
SE142C-384\_FLAT\_NEW-254

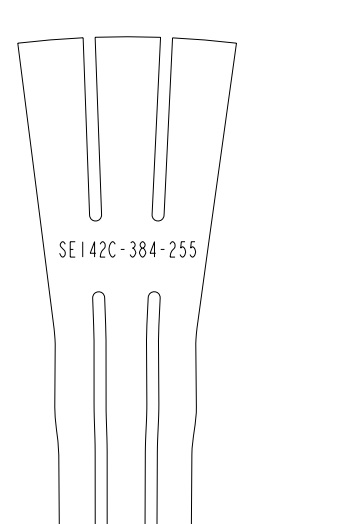

106

INSTANCE:  
SE142C-384\_FLAT\_NEW-255

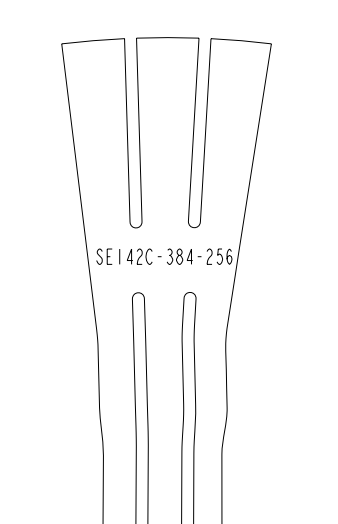

107

INSTANCE:  
SE142C-384\_FLAT\_NEW-256

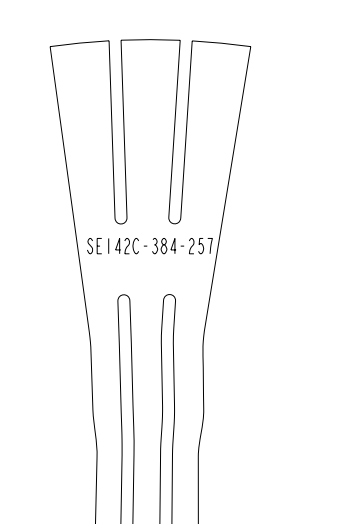

108

INSTANCE:  
SE142C-384\_FLAT\_NEW-257

⚠ THESE PARTS TO BE NEMA GRADE GIICR MATERIAL

SCALE ALL VIEWS: 1.00

UT-BATTELLE		Oak Ridge National Laboratory managed for the DEPARTMENT OF ENERGY under U.S. GOVERNMENT contract DE-AC05-00OR22725 UT-BATTELLE, LLC. Oak Ridge, Tennessee	
<b>NATIONAL COMPACT STELLARATOR EXPERIMENT</b>			
<b>MODULAR COIL TYPE - C</b>			
<b>SIDE - A LOWER CLADDING</b>			
<b>FLAT PATTERN LAYOUT</b>			
VERSION NO. 3+	PLANT X-10	BLDG 5700	FL SHT OF TYPE CLASS 3 5 5 S U
RELEASE LEVEL WIP		SE142C-384	