

- DRAWING PREPARED IN ACCORDANCE WITH ASME Y14.100-2000.
- INTERPRET DIMENSIONS AND TOLERANCES PER ANSI Y14.5M-1994.
- DIMENSIONS ARE IN INCHES.
- DRAWING DEPICTS FLAT PATTERN OF FORMED PARTS DEFINED BY PRO/ENGINEER FILES SEI42C-386-XXX.PRT.
- PROFILE TOLERANCE OF FLAT PATTERN IS +/- .010 IN.
- THICKNESS IS 0.040 +/- .006 IN. PER ASTM B248.
- REMOVE ALL BURRS AND SHARP EDGES.
- IDENTIFY PARTS WITH "PART NAME" BY ETCHING OR PERMANENT MARKER.
- PARTS INDICATED ARE TO BE NEMA GRADE GIICR MATERIAL.

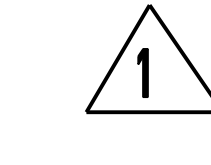

2

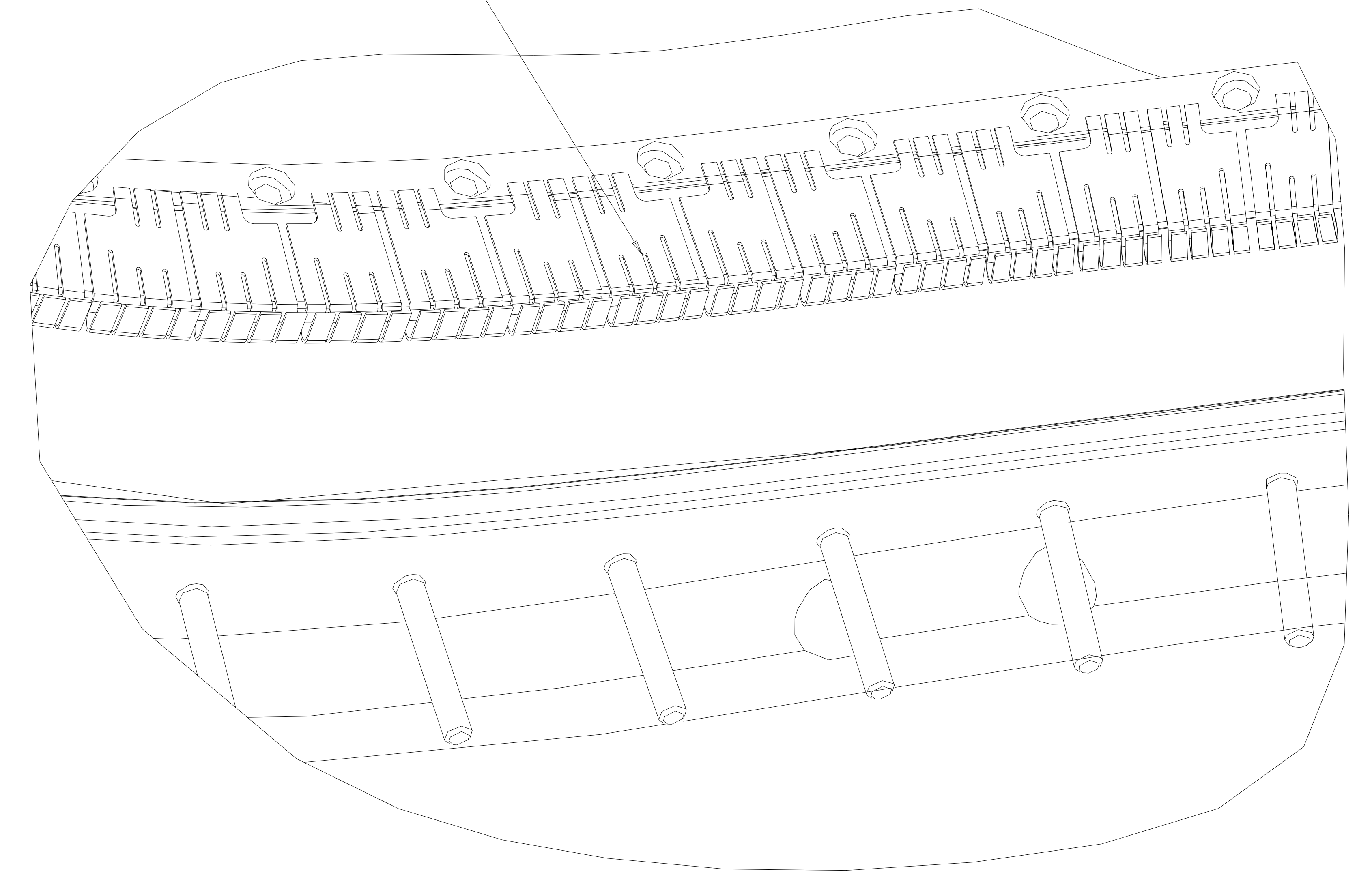

ISOMETRIC VIEW
SCALE 1:00

INSTANCE NAME	HOLE	S-DIM	PART NAME
SEI42C-386_FLAT_270		0.885417	SEI42C-386-270
SEI42C-386_FLAT_271	1	0.890625	SEI42C-386-271
SEI42C-386_FLAT_272		0.895833	SEI42C-386-272
SEI42C-386_FLAT_273	2	0.901042	SEI42C-386-273
SEI42C-386_FLAT_274		0.906250	SEI42C-386-274
SEI42C-386_FLAT_275	3	0.911458	SEI42C-386-275
SEI42C-386_FLAT_276		0.916667	SEI42C-386-276
SEI42C-386_FLAT_277	4	0.921875	SEI42C-386-277
SEI42C-386_FLAT_278		0.927083	SEI42C-386-278
SEI42C-386_FLAT_279	5	0.932292	SEI42C-386-279
SEI42C-386_FLAT_280		0.937500	SEI42C-386-280
SEI42C-386_FLAT_281	6	0.942708	SEI42C-386-281
SEI42C-386_FLAT_282		0.947917	SEI42C-386-282
SEI42C-386_FLAT_283	7	0.953125	SEI42C-386-283
SEI42C-386_FLAT_284		0.958333	SEI42C-386-284
SEI42C-386_FLAT_285	8	0.963542	SEI42C-386-285
SEI42C-386_FLAT_286		0.968750	SEI42C-386-286
SEI42C-386_FLAT_287	9	0.973958	SEI42C-386-287
SEI42C-386_FLAT_288		0.979167	SEI42C-386-288
SEI42C-386_FLAT_289	10	0.984375	SEI42C-386-289
SEI42C-386_FLAT_290-NEW		0.989583	SEI42C-386-290
SEI42C-386_FLAT_291	11	0.994792	SEI42C-386-291
SEI42C-386_FLAT_290		0.000000	SEI42C-386-292
SEI42C-386_FLAT_102	12	0.005208	SEI42C-386-101
SEI42C-386_FLAT_103		0.010417	SEI42C-386-102
SEI42C-386_FLAT_103-NEW	13	0.015625	SEI42C-386-103
SEI42C-386_FLAT_104-NEW		0.019341	SEI42C-386-104
SEI42C-386_FLAT_106-NEW	14	0.022505	SEI42C-386-106
SEI42C-386_FLAT_107-NEW		0.036000	SEI42C-486-107
SEI42C-386_FLAT_107-108	15	0.041000	SEI42C-386-108
SEI42C-386_FLAT_109		0.046875	SEI42C-386-109
SEI42C-386_FLAT_110	16	0.052083	SEI42C-386-110
SEI42C-386_FLAT_111		0.057292	SEI42C-386-111
SEI42C-386_FLAT_112	17	0.062500	SEI42C-386-112
SEI42C-386_FLAT_113		0.067708	SEI42C-386-113
SEI42C-386_FLAT_114	18	0.072917	SEI42C-386-114
SEI42C-386_FLAT_115		0.078125	SEI42C-386-115
SEI42C-386_FLAT_116	19	0.083333	SEI42C-386-116
SEI42C-386_FLAT_117		0.088542	SEI42C-386-117
SEI42C-386_FLAT_118	20	0.093750	SEI42C-386-118
SEI42C-386_FLAT_119		0.098958	SEI42C-386-119
SEI42C-386_FLAT_120	21	0.104167	SEI42C-386-120
SEI42C-386_FLAT_121		0.109375	SEI42C-386-121
SEI42C-386_FLAT_122	22	0.114583	SEI42C-386-122
SEI42C-386_FLAT_123		0.119792	SEI42C-386-123
SEI42C-386_FLAT_124	23	0.125000	SEI42C-386-124
SEI42C-386_FLAT_125		0.130208	SEI42C-386-125
SEI42C-386_FLAT_126	24	0.135417	SEI42C-386-126
SEI42C-386_FLAT_127		0.140625	SEI42C-386-127
SEI42C-386_FLAT_128	25	0.145833	SEI42C-386-128
SEI42C-386_FLAT_129		0.151042	SEI42C-386-129
SEI42C-386_FLAT_130	26	0.156250	SEI42C-386-130
SEI42C-386_FLAT_131		0.161458	SEI42C-386-131
SEI42C-386_FLAT_132	27	0.166667	SEI42C-386-132
SEI42C-386_FLAT_133		0.171875	SEI42C-386-133
SEI42C-386_FLAT_134	28	0.177083	SEI42C-386-134
SEI42C-386_FLAT_135		0.182292	SEI42C-386-135
SEI42C-386_FLAT_136	29	0.187500	SEI42C-386-136
SEI42C-386_FLAT_137		0.192708	SEI42C-386-137
SEI42C-386_FLAT_138	30	0.197917	SEI42C-386-138
SEI42C-386_FLAT_139		0.203125	SEI42C-386-139
SEI42C-386_FLAT_140	31	0.208333	SEI42C-386-140
SEI42C-386_FLAT_141		0.213542	SEI42C-386-141
SEI42C-386_FLAT_142	32	0.218750	SEI42C-386-142
SEI42C-386_FLAT_143		0.223958	SEI42C-386-143
SEI42C-386_FLAT_144	33	0.229167	SEI42C-386-144
SEI42C-386_FLAT_145		0.234375	SEI42C-386-145
SEI42C-386_FLAT_146	34	0.239583	SEI42C-386-146
SEI42C-386_FLAT_147		0.244792	SEI42C-386-147
SEI42C-386_FLAT_148	35	0.250000	SEI42C-386-148
SEI42C-386_FLAT_149		0.255208	SEI42C-386-149
SEI42C-386_FLAT_150	36	0.260417	SEI42C-386-150
SEI42C-386_FLAT_151		0.265625	SEI42C-386-151
SEI42C-386_FLAT_152	37	0.270833	SEI42C-386-152
SEI42C-386_FLAT_153		0.276042	SEI42C-386-153
SEI42C-386_FLAT_154	38	0.281250	SEI42C-386-154
SEI42C-386_FLAT_155		0.286458	SEI42C-386-155
SEI42C-386_FLAT_156	39	0.291667	SEI42C-386-156
SEI42C-386_FLAT_157		0.296875	SEI42C-386-157
SEI42C-386_FLAT_158	40	0.302083	SEI42C-386-158
SEI42C-386_FLAT_159		0.307292	SEI42C-386-159
SEI42C-386_FLAT_160	41	0.312500	SEI42C-386-160
SEI42C-386_FLAT_161		0.317708	SEI42C-386-161
SEI42C-386_FLAT_162	42	0.322917	SEI42C-386-162
SEI42C-386_FLAT_163		0.328125	SEI42C-386-163
SEI42C-386_FLAT_164	43	0.333333	SEI42C-386-164
SEI42C-386_FLAT_165		0.338542	SEI42C-386-165
SEI42C-386_FLAT_166	44	0.343750	SEI42C-386-166
SEI42C-386_FLAT_167		0.348958	SEI42C-386-167
SEI42C-386_FLAT_168	45	0.354167	SEI42C-386-168
SEI42C-386_FLAT_169		0.359375	SEI42C-386-169
SEI42C-386_FLAT_170	46	0.364583	SEI42C-386-170
SEI42C-386_FLAT_171		0.369792	SEI42C-386-171
SEI42C-386_FLAT_172	47	0.375000	SEI42C-386-172
SEI42C-386_FLAT_173		0.380208	SEI42C-386-173

INSTANCE NAME	HOLE	S-DIM	PART NAME
SEI42C-386_FLAT_174		0.385417	SEI42C-386-174
SEI42C-386_FLAT_175	49	0.390625	SEI42C-386-175
SEI42C-386_FLAT_176		0.395833	SEI42C-386-176
SEI42C-386_FLAT_177	50	0.401042	SEI42C-386-177
SEI42C-386_FLAT_178		0.406250	SEI42C-386-178
SEI42C-386_FLAT_179	51	0.411458	SEI42C-386-179
SEI42C-386_FLAT_180		0.416667	SEI42C-386-180
SEI42C-386_FLAT_181	52	0.421875	SEI42C-386-181
SEI42C-386_FLAT_182		0.427083	SEI42C-386-182
SEI42C-386_FLAT_183	53	0.432292	SEI42C-386-183
SEI42C-386_FLAT_184		0.437500	SEI42C-386-184
SEI42C-386_FLAT_185	54	0.442708	SEI42C-386-185
SEI42C-386_FLAT_186		0.447917	SEI42C-386-186
SEI42C-386_FLAT_187	55	0.453125	SEI42C-386-187
SEI42C-386_FLAT_188		0.458333	SEI42C-386-188
SEI42C-386_FLAT_189	56	0.463542	SEI42C-386-189
SEI42C-386_FLAT_190		0.468750	SEI42C-386-190
SEI42C-386_FLAT_191	57	0.473958	SEI42C-386-191
SEI42C-386_FLAT_192		0.479167	SEI42C-386-192
SEI42C-386_FLAT_193	58	0.484375	SEI42C-386-193
SEI42C-386_FLAT_194		0.489583	SEI42C-386-194
SEI42C-386_FLAT_195-NEW	59	0.494792	SEI42C-386-195
SEI42C-386_FLAT_196-NEW		0.500000	SEI42C-386-196
SEI42C-386_FLAT_197	60	0.505208	SEI42C-386-197
SEI42C-386_FLAT_198-NEW		0.510417	SEI42C-386-198
SEI42C-386_FLAT_199-NEW	61	0.515625	SEI42C-386-199
SEI42C-386_FLAT_198		0.520833	SEI42C-386-200
SEI42C-386_FLAT_201	62	0.526042	SEI42C-386-201
SEI42C-386_FLAT_202		0.531250	SEI42C-386-202
SEI42C-386_FLAT_203	63	0.536458	SEI42C-386-203
SEI42C-386_FLAT_204		0.541667	SEI42C-386-204
SEI42C-386_FLAT_205	64	0.546875	SEI42C-386-205
SEI42C-386_FLAT_206		0.552083	SEI42C-386-206
SEI42C-386_FLAT_207	65	0.557292	SEI42C-386-207
SEI42C-386_FLAT_208		0.562500	SEI42C-386-208
SEI42C-386_FLAT_209	66	0.567708	SEI42C-386-209
SEI42C-386_FLAT_210		0.572917	SEI42C-386-210
SEI42C-386_FLAT_211	67	0.578125	SEI42C-386-211
SEI42C-386_FLAT_212		0.583334	SEI42C-386-212
SEI42C-386_FLAT_213	68	0.588542	SEI42C-386-213
SEI42C-386_FLAT_214		0.593750	SEI42C-386-214
SEI42C-386_FLAT_215	69	0.598959	SEI42C-386-215
SEI42C-386_FLAT_216		0.604167	SEI42C-386-216
SEI42C-386_FLAT_217	70	0.609375	SEI42C-386-217
SEI42C-386_FLAT_218		0.614584	SEI42C-386-218
SEI42C-386_FLAT_219	71	0.619792	SEI42C-386-219
SEI42C-386_FLAT_220		0.625000	SEI42C-386-220
SEI42C-386_FLAT_221	72	0.630209	SEI42C-386-221
SEI42C-386_FLAT_222		0.635417	SEI42C-386-222
SEI42C-386_FLAT_223	73	0.640625	SEI42C-386-223
SEI42C-386_FLAT_224		0.645834	SEI42C-386-224
SEI42C-386_FLAT_225	74	0.651042	SEI42C-386-225
SEI42C-386_FLAT_226		0.656250	SEI42C-386-226
SEI42C-386_FLAT_227	75	0.661458	SEI42C-386-227
SEI42C-386_FLAT_228		0.666667	SEI42C-386-228
SEI42C-386_FLAT_229	76	0.671875	SEI42C-386-229
SEI42C-386_FLAT_230		0.677083	SEI42C-386-230
SEI42C-386_FLAT_231	77	0.682292	SEI42C-386-231
SEI42C-386_FLAT_232		0.687500	SEI42C-386-232
SEI42C-386_FLAT_233	78	0.692708	SEI42C-386-233
SEI42C-386_FLAT_234		0.697917	SEI42C-386-234
SEI42C-386_FLAT_235	79	0.703125	SEI42C-386-235
SEI42C-386_FLAT_236		0.708333	SEI42C-386-236
SEI42C-386_FLAT_237	80	0.713542	SEI42C-386-237
SEI42C-386_FLAT_238		0.718750	SEI42C-386-238
SEI42C-386_FLAT_239	81	0.723958	SEI42C-386-239
SEI42C-386_FLAT_240		0.729167	SEI42C-386-240
SEI42C-386_FLAT_241	82	0.734375	SEI42C-386-241
SEI42C-386_FLAT_242		0.739583	SEI42C-386-242
SEI42C-386_FLAT_243	83	0.744792	SEI42C-386-243
SEI42C-386_FLAT_244		0.750000	SEI42C-386-244
SEI42C-386_FLAT_245	84	0.755208	SEI42C-386-245
SEI42C-386_FLAT_246		0.760417	SEI42C-386-246
SEI42C-386_FLAT_247	85	0.765625	SEI42C-386-247
SEI42C-386_FLAT_248		0.770833	SEI42C-386-248
SEI42C-386_FLAT_249	86	0.776042	SEI42C-386-249
SEI42C-386_FLAT_250		0.781250	SEI42C-386-250
SEI42C-386_FLAT_251	87	0.786458	SEI42C-386-251
SEI42C-386_FLAT_252		0.791667	SEI42C-386-252
SEI42C-386_FLAT_253	88	0.796875	SEI42C-386-253
SEI42C-386_FLAT_254		0.802083	SEI42C-386-254
SEI42C-386_FLAT_255	89	0.807292	SEI42C-386-255
SEI42C-386_FLAT_256		0.812500	SEI42C-386-256
SEI42C-386_FLAT_257	90	0.817708	SEI42C-386-257
SEI42C-386_FLAT_258		0.822917	SEI42C-386-258
SEI42C-386_FLAT_259	91	0.828125	SEI42C-386-259
SEI42C-386_FLAT_260		0.833333	SEI42C-386-260
SEI42C-386_FLAT_261	92	0.838542	SEI42C-386-261
SEI42C-386_FLAT_262		0.843750	SEI42C-386-262
SEI42C-386_FLAT_263	93	0.848958	SEI42C-386-263
SEI42C-386_FLAT_264		0.854167	SEI42C-386-264
SEI42C-386_FLAT_265	94	0.859375	SEI42C-386-265
SEI42C-386_FLAT_266		0.864583	SEI42C-386-266
SEI42C-386_FLAT_267	95	0.869792	SEI42C-386-267
SEI42C-386_FLAT_268		0.875000	SEI42C-386-2



THESE PARTS TO BE NEMA GRADE GIICR MATERIAL

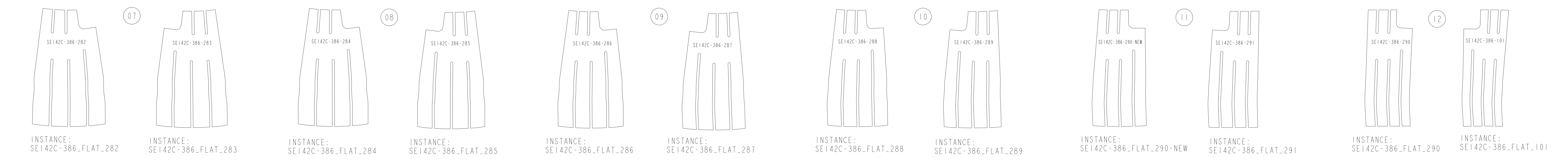
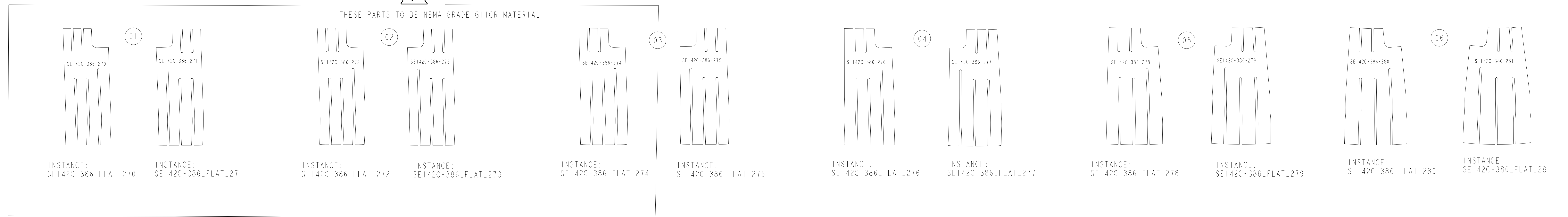

POLODIAL BREAK

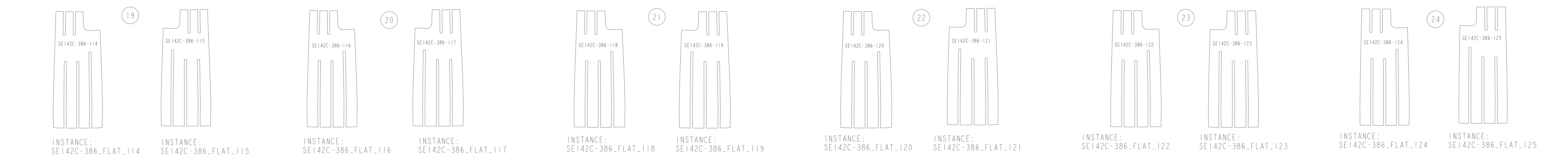
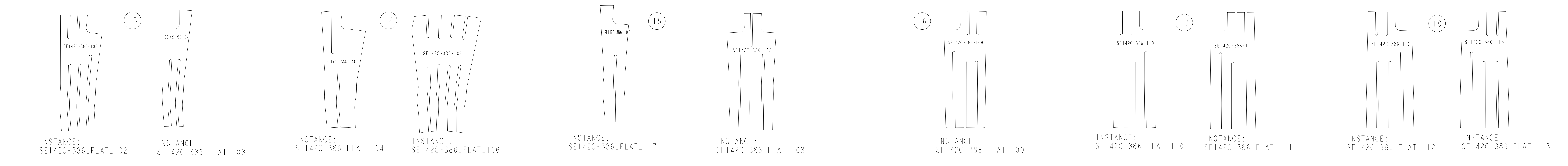

SCALE ALL VIEWS: 1.00

UT-BATTELLE		Oak Ridge National Laboratory managed for the DEPARTMENT OF ENERGY under U.S. GOVERNMENT contract DE-AC05-00OR22725 UT-BATTELLE, LLC. Oak Ridge, Tennessee	
PROJECT NAME			
NATIONAL COMPACT STELLARATOR EXPERIMENT			
MODULAR COIL TYPE - C			
SIDE -A UPPER (TOP) CHILL PLATES			
FLAT PATTERN LAYOUT			
VERSION NO.	PLANT	BLDG	FL SHT OF TYPE CLASS
***	X-10	5700	3 2 5 S U
RELEASE LEVEL		SEI42C-386	
U		REV I	

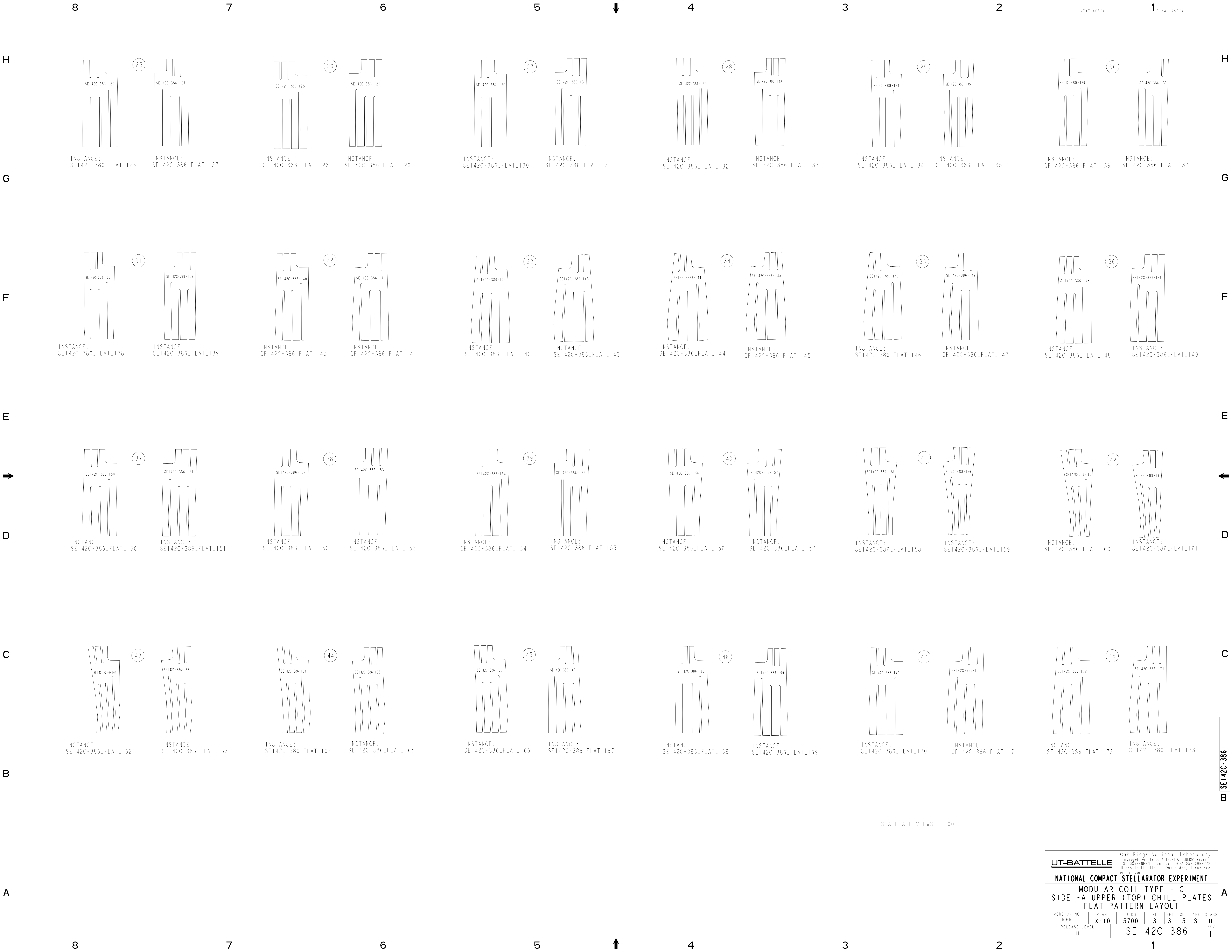

SCALE ALL VIEWS: 1.00

Oak Ridge National Laboratory managed for the DEPARTMENT OF ENERGY under U.S. GOVERNMENT CONTRACT DE-AC05-00OR22725 UT-BATTELLE, LLC., Oak Ridge, Tennessee PROJECT NAME							
NATIONAL COMPACT STELLARATOR EXPERIMENT							
MODULAR COIL TYPE - C							
SIDE -A UPPER (TOP) CHILL PLATES							
FLAT PATTERN LAYOUT							
VERSION NO.	PLANT	BLDG	FL	SHT	OF	TYPE	CLASS
***	X-10	5700	3	3	5	S	U
RELEASE LEVEL		SEI42C-386				REV	
U						I	

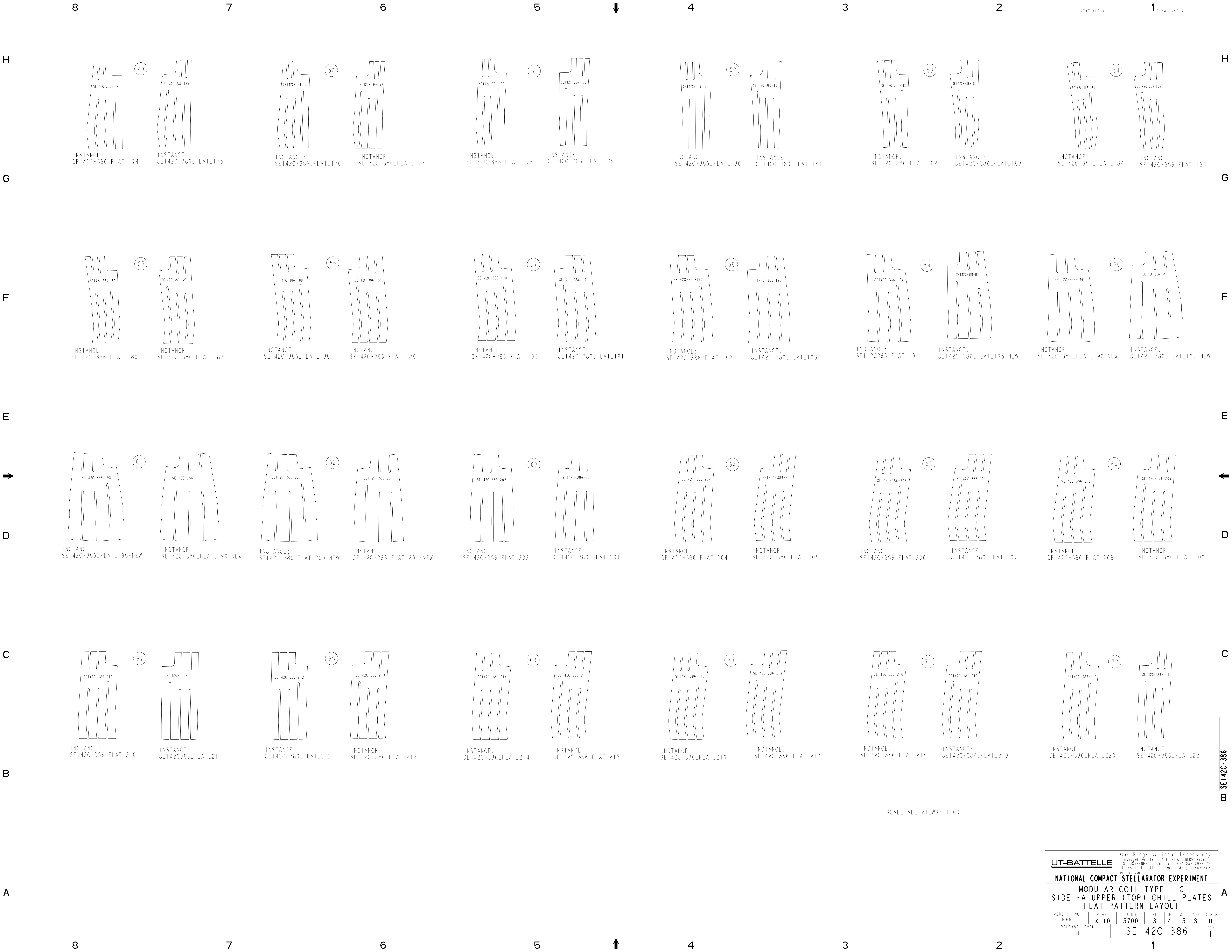

SCALE ALL VIEWS: 1.00

UT-BATTELLE		Oak Ridge National Laboratory managed for the DEPARTMENT OF ENERGY under U.S. GOVERNMENT CONTRACT DE-AC05-00OR22725 UT-BATTELLE, LLC, Oak Ridge, Tennessee	
PROJECT NAME			
NATIONAL COMPACT STELLARATOR EXPERIMENT			
MODULAR COIL TYPE - C			
SIDE -A UPPER (TOP) CHILL PLATES			
FLAT PATTERN LAYOUT			
VERSION NO.	PLANT	BLDG	FL SHT OF TYPE CLASS
***	X-10	5700	3 4 5 S U
RELEASE LEVEL		SEI42C-386	
U		REV I	

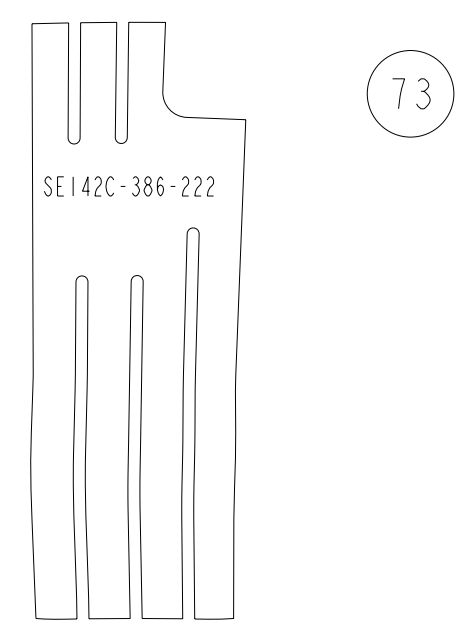

73

INSTANCE:
SE142C-386_FLAT_222

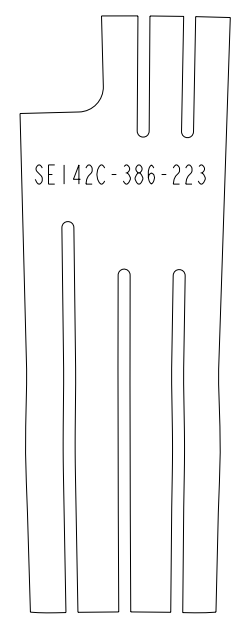

74

INSTANCE:
SE142C-386_FLAT_223

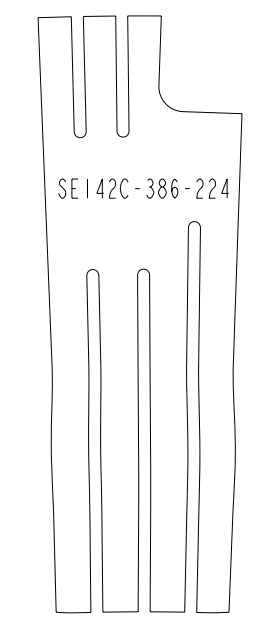

75

INSTANCE:
SE142C-386_FLAT_224

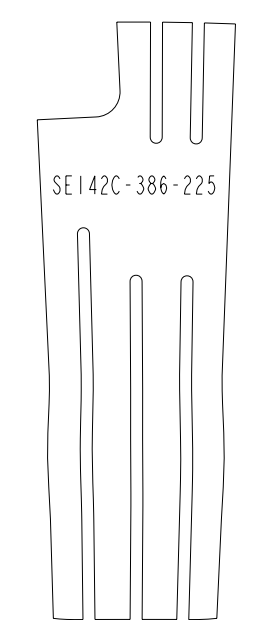

76

INSTANCE:
SE142C-386_FLAT_225

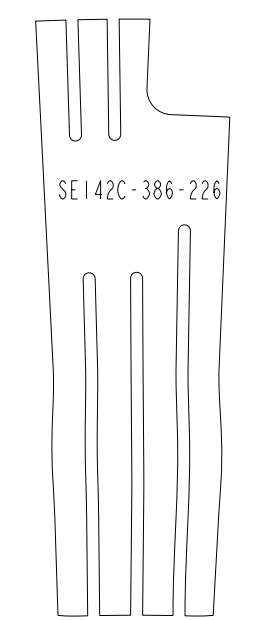

77

INSTANCE:
SE142C-386_FLAT_226

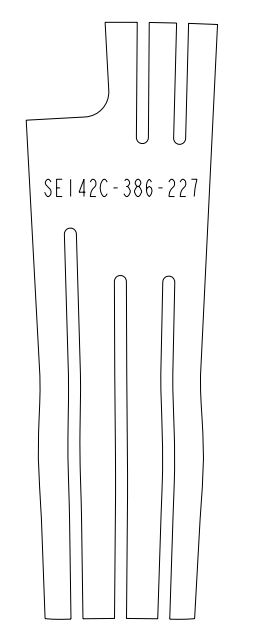

78

INSTANCE:
SE142C-386_FLAT_227

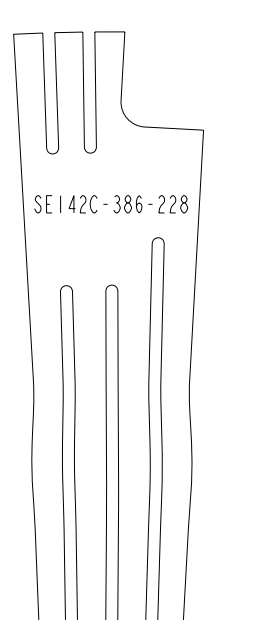

79

INSTANCE:
SE142C-386_FLAT_228

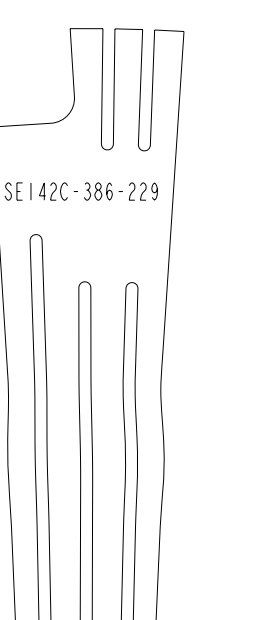

80

INSTANCE:
SE142C-386_FLAT_229

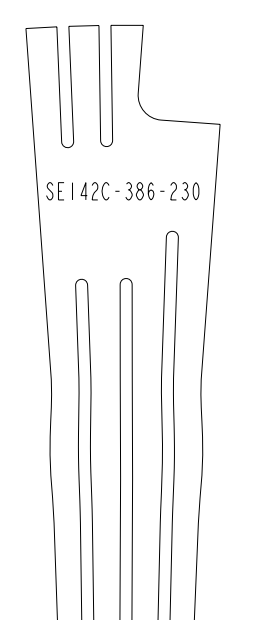

81

INSTANCE:
SE142C-386_FLAT_230

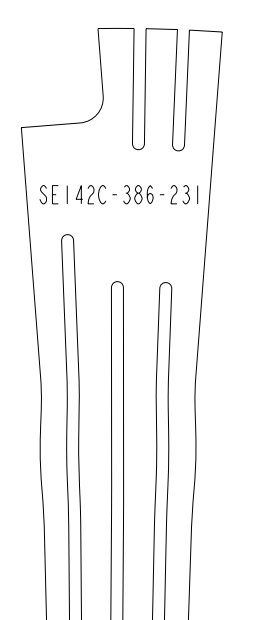

82

INSTANCE:
SE142C-386_FLAT_231

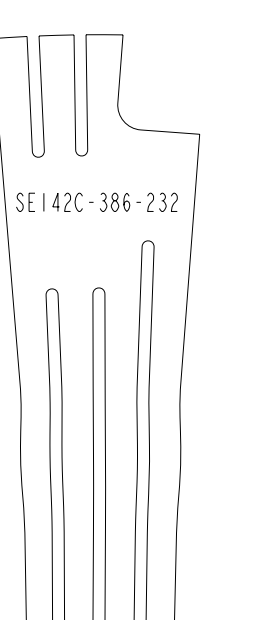

83

INSTANCE:
SE142C-386_FLAT_232

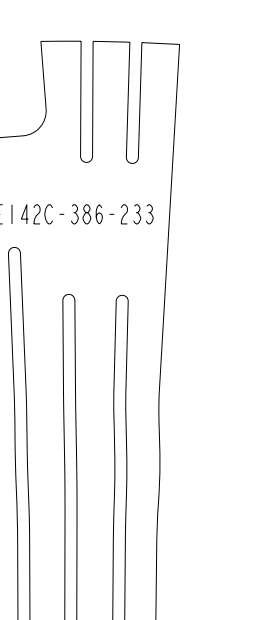

84

INSTANCE:
SE142C-386_FLAT_233

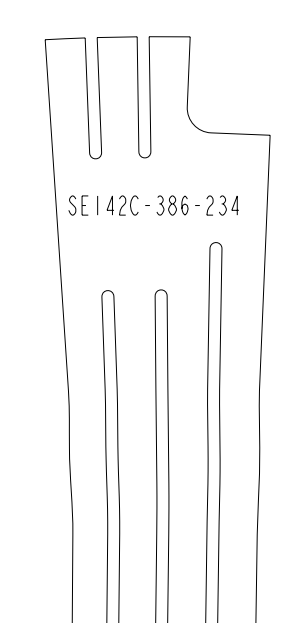

85

INSTANCE:
SE142C-386_FLAT_234

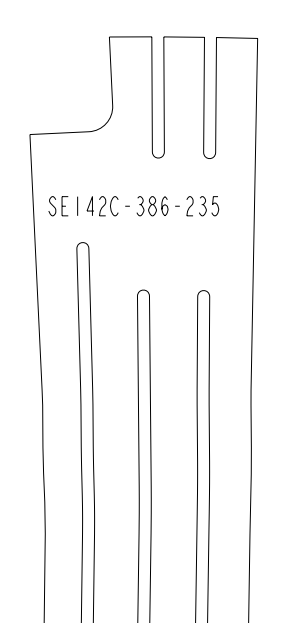

86

INSTANCE:
SE142C-386_FLAT_235

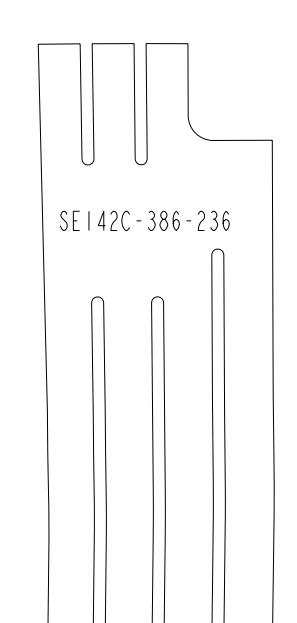

87

INSTANCE:
SE142C-386_FLAT_236

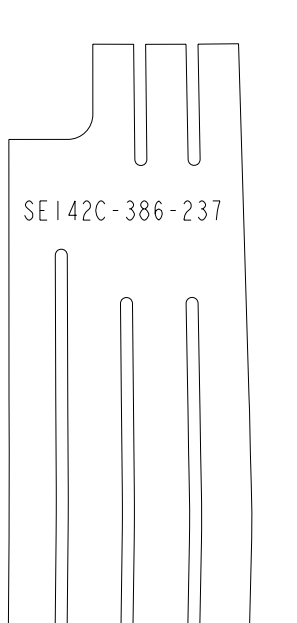

88

INSTANCE:
SE142C-386_FLAT_237

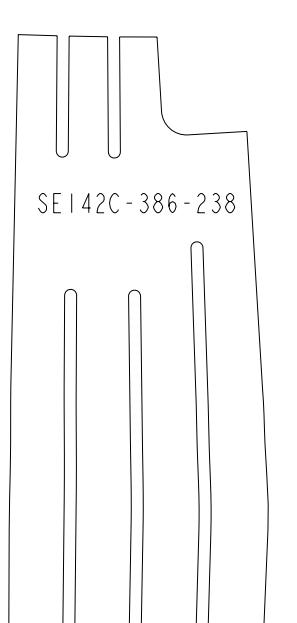

89

INSTANCE:
SE142C-386_FLAT_238

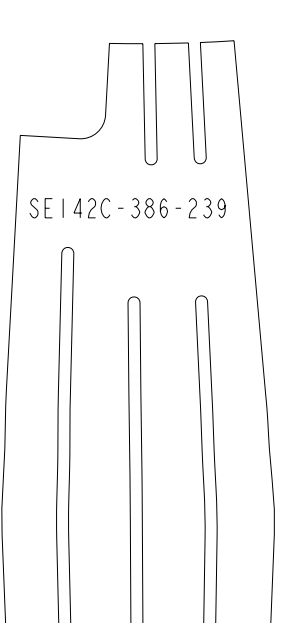

90

INSTANCE:
SE142C-386_FLAT_239

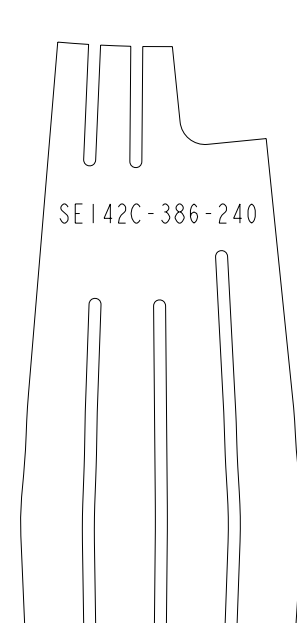

91

INSTANCE:
SE142C-386_FLAT_240

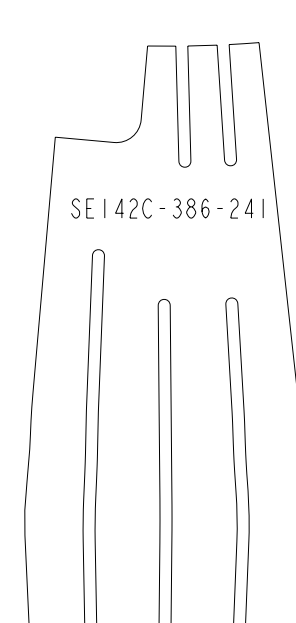

92

INSTANCE:
SE142C-386_FLAT_241

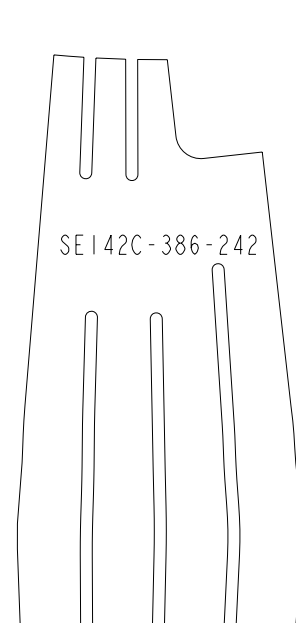

93

INSTANCE:
SE142C-386_FLAT_242

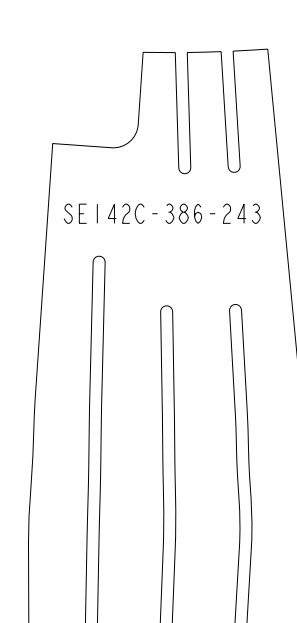

94

INSTANCE:
SE142C-386_FLAT_243

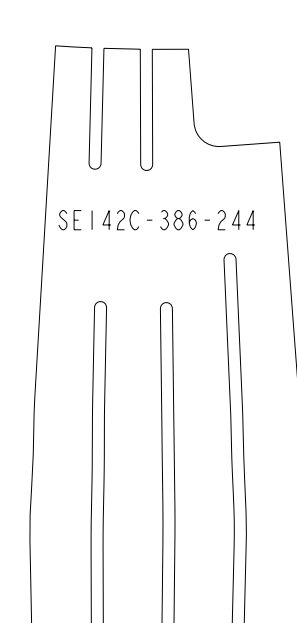

95

INSTANCE:
SE142C-386_FLAT_244

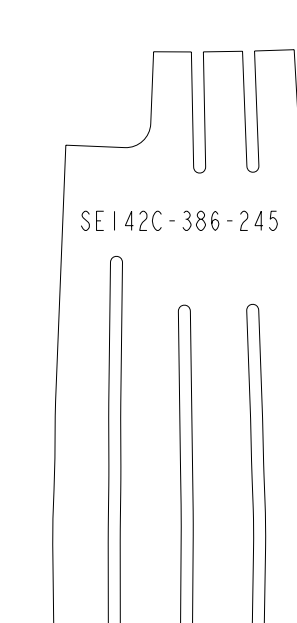

96

INSTANCE:
SE142C-386_FLAT_245

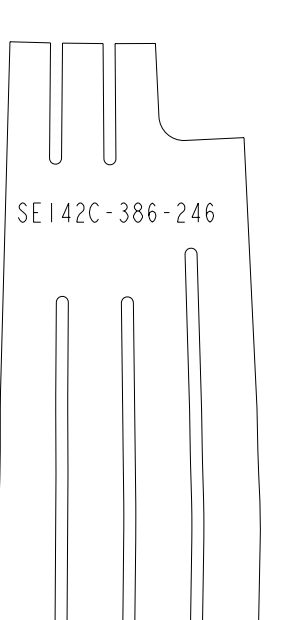

97

INSTANCE:
SE142C-386_FLAT_246

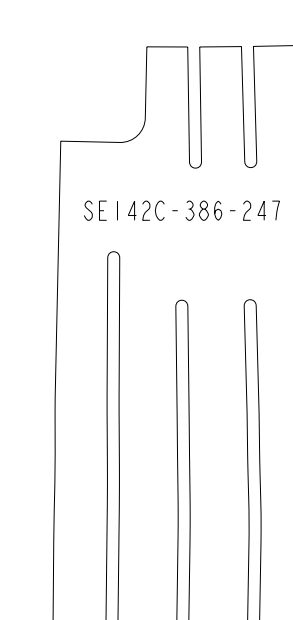

98

INSTANCE:
SE142C-386_FLAT_247

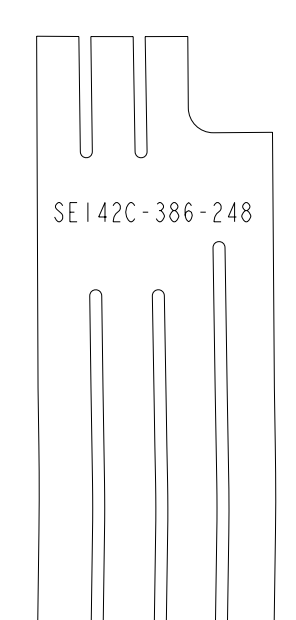

99

INSTANCE:
SE142C-386_FLAT_248

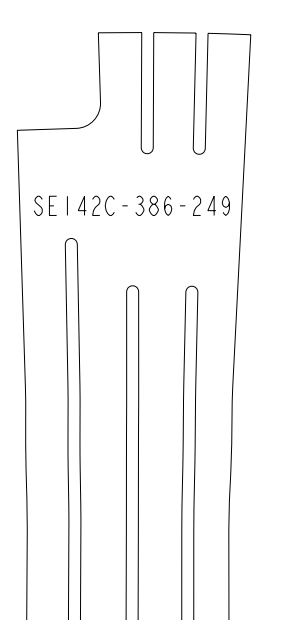

100

INSTANCE:
SE142C-386_FLAT_249

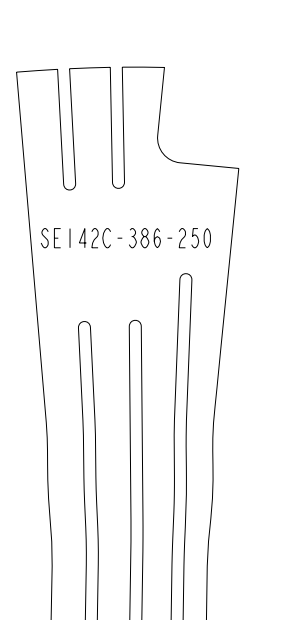

101

INSTANCE:
SE142C-386_FLAT_250

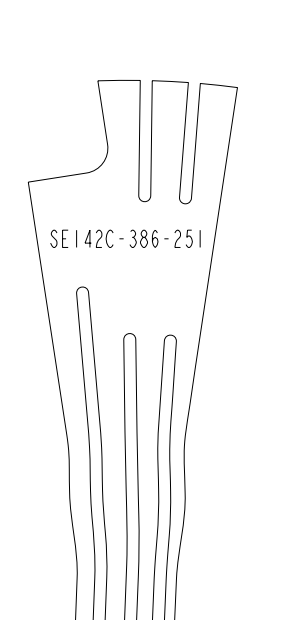

102

INSTANCE:
SE142C-386_FLAT_251

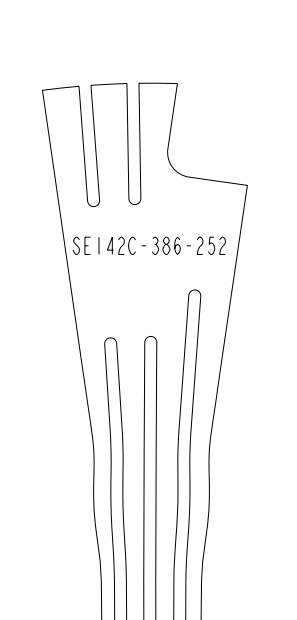

103

INSTANCE:
SE142C-386_FLAT_252

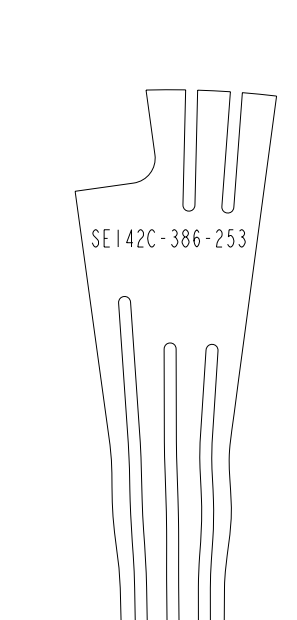

104

INSTANCE:
SE142C-386_FLAT_253

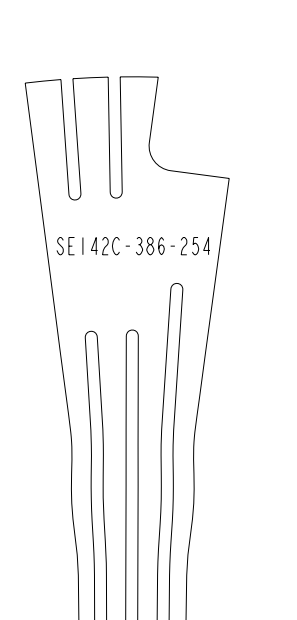

105

INSTANCE:
SE142C-386_FLAT_254

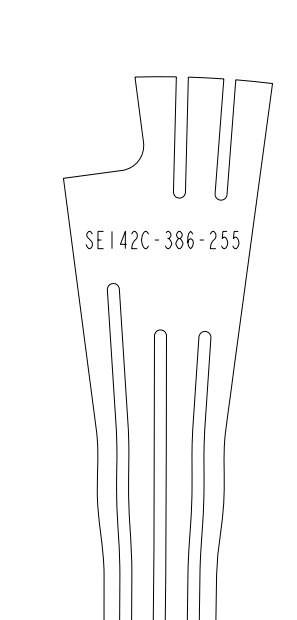

106

INSTANCE:
SE142C-386_FLAT_255

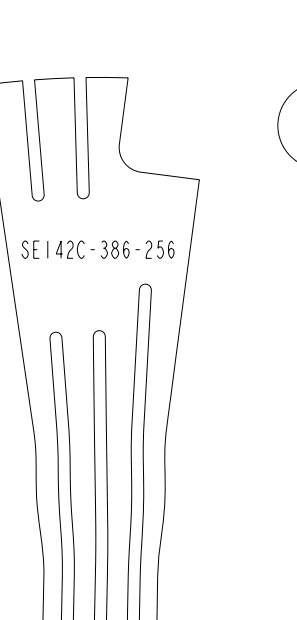

107

INSTANCE:
SE142C-386_FLAT_256



108

INSTANCE:
SE142C-386_FLAT_257

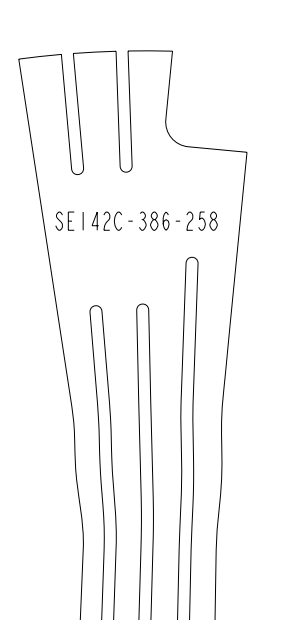

109

INSTANCE:
SE142C-386_FLAT_258

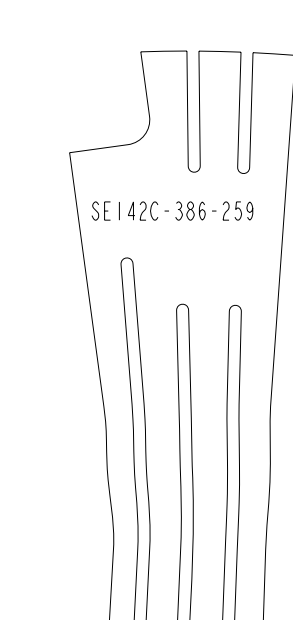

110

INSTANCE:
SE142C-386_FLAT_259

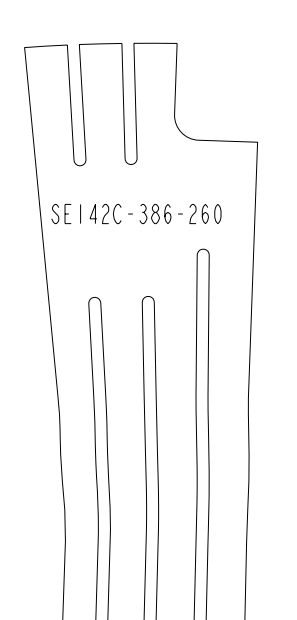

111

INSTANCE:
SE142C-386_FLAT_260

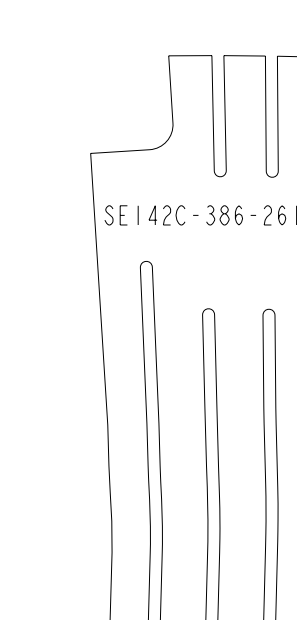

112

INSTANCE:
SE142C-386_FLAT_261

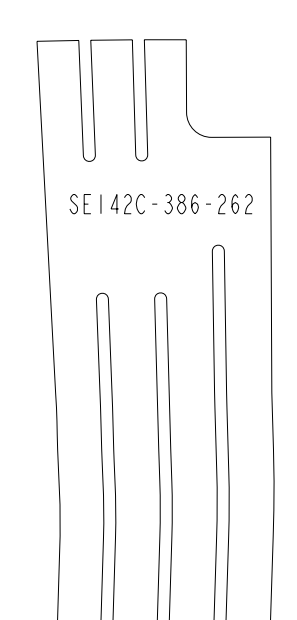

113

INSTANCE:
SE142C-386_FLAT_262

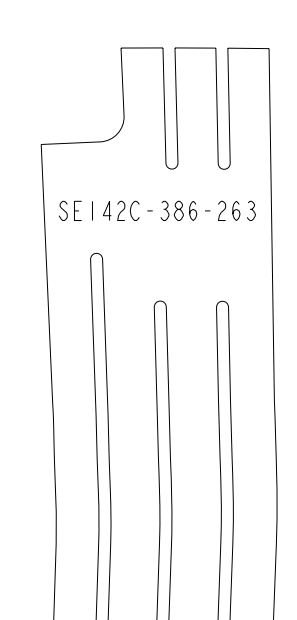

114

INSTANCE:
SE142C-386_FLAT_263

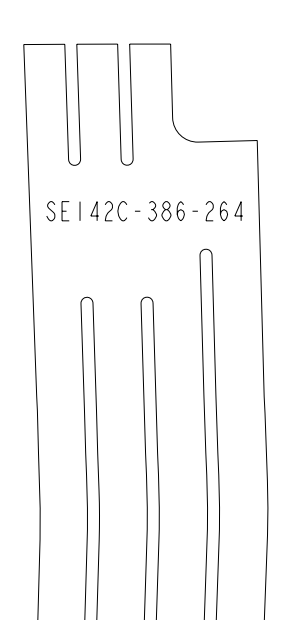

115

INSTANCE:
SE142C-386_FLAT_264

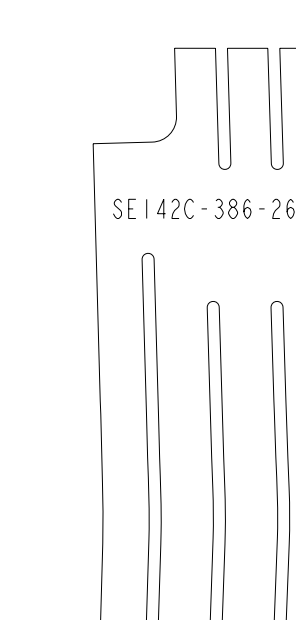

116

INSTANCE:
SE142C-386_FLAT_265

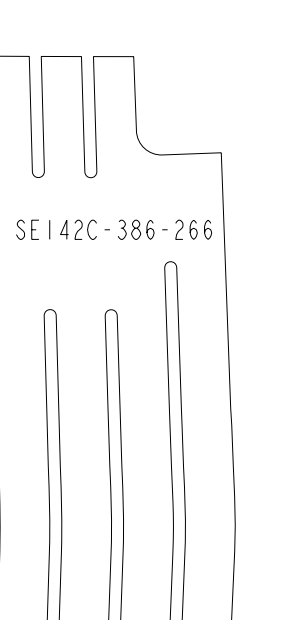

117

INSTANCE:
SE142C-386_FLAT_266

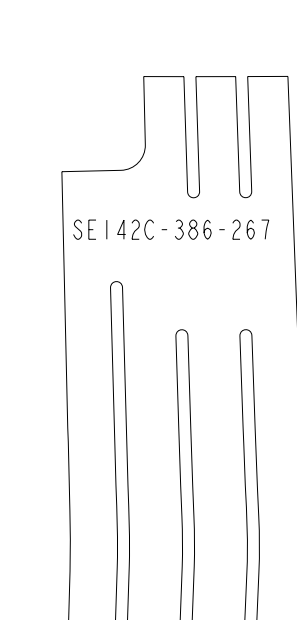

118

INSTANCE:
SE142C-386_FLAT_267

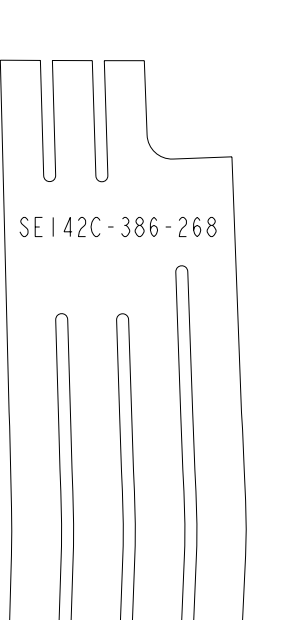

119

INSTANCE:
SE142C-386_FLAT_268

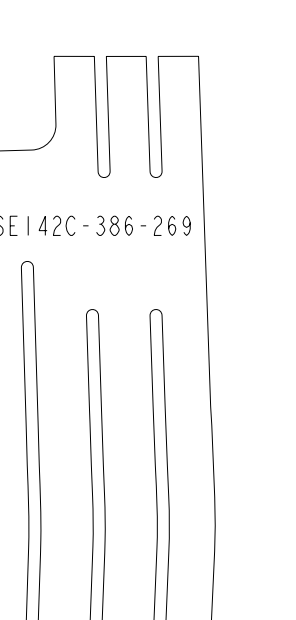

120

INSTANCE:
SE142C-386_FLAT_269

▲

THESE PARTS TO BE NEMA GRADE GIICR MATERIAL

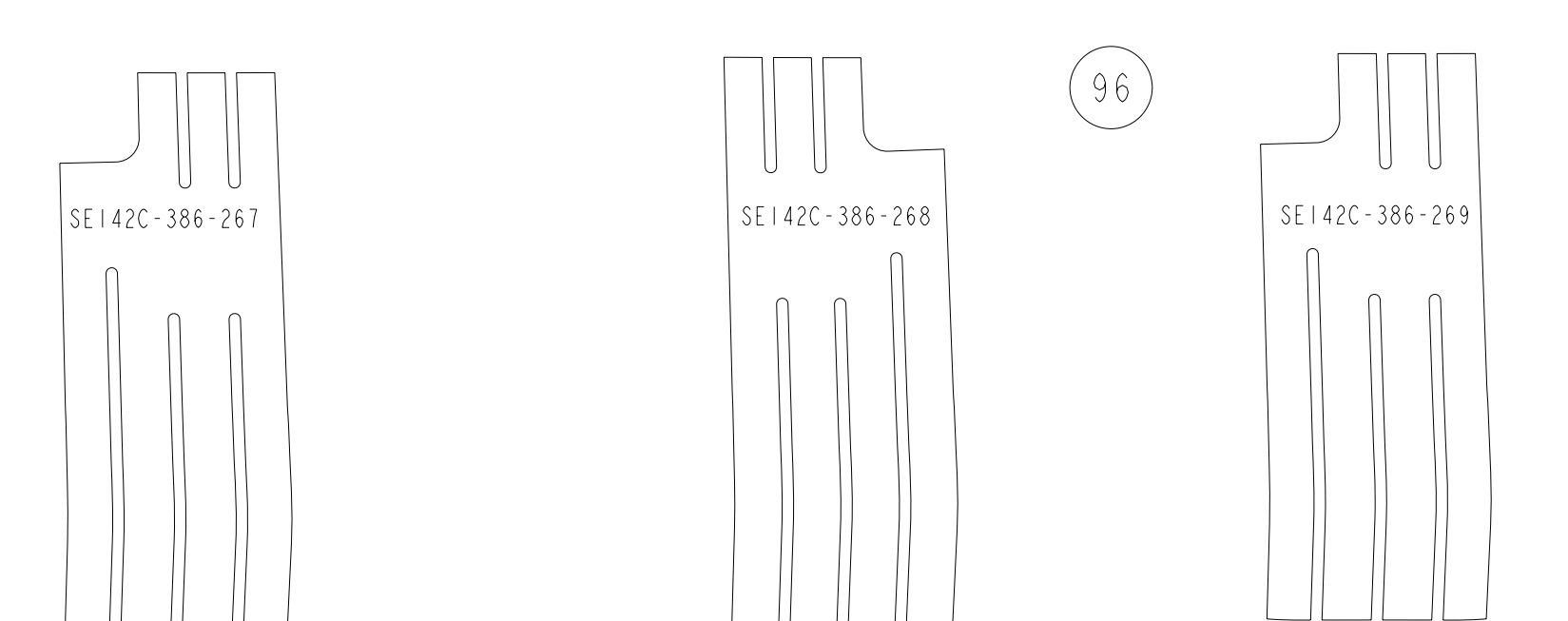

INSTANCE:
SE142C-386_FLAT_267

INSTANCE:
SE142C-386_FLAT_268

INSTANCE:
SE142C-386_FLAT_269

SCALE ALL VIEWS: 1.00

UT-BATTELLE		Oak Ridge National Laboratory managed for the DEPARTMENT OF ENERGY under U.S. GOVERNMENT CONTRACT DE-AC05-00OR22725 UT-BATTELLE, LLC, Oak Ridge, Tennessee	
PROJECT NAME			
NATIONAL COMPACT STELLARATOR EXPERIMENT			
MODULAR COIL TYPE - C			
SIDE -A UPPER (TOP) CHILL PLATES			
FLAT PATTERN LAYOUT			
VERSION NO. 3	PLANT X-10	BLDG 5700	FL SHT OF TYPE CLASS 3 5 5 S U
RELEASE LEVEL WIP		SE142C-386	