

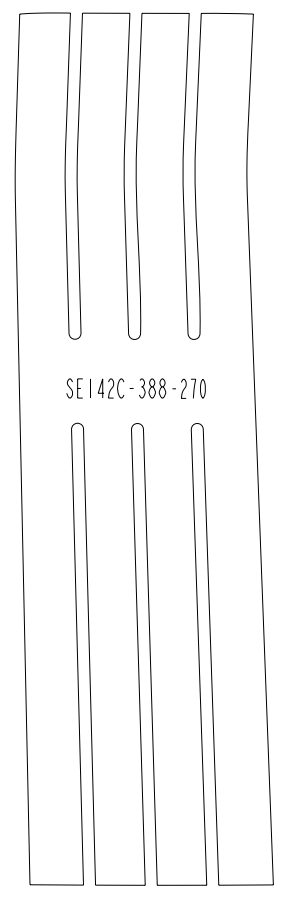

2

THESE PARTS TO BE NEMA GRADE G11CR MATERIAL

01



INSTANCE  
SE142C-388\_FLAT\_270

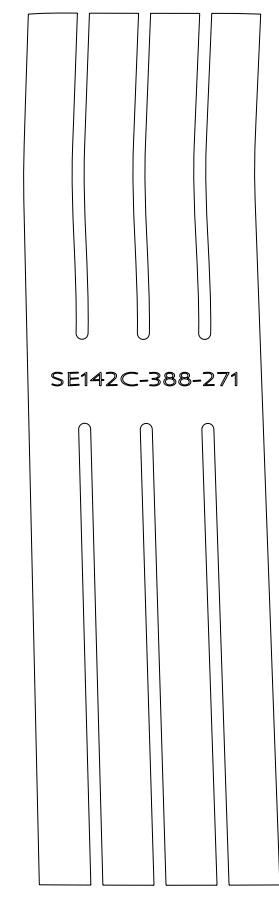

INSTANCE  
SE142C-388\_FLAT\_271

02

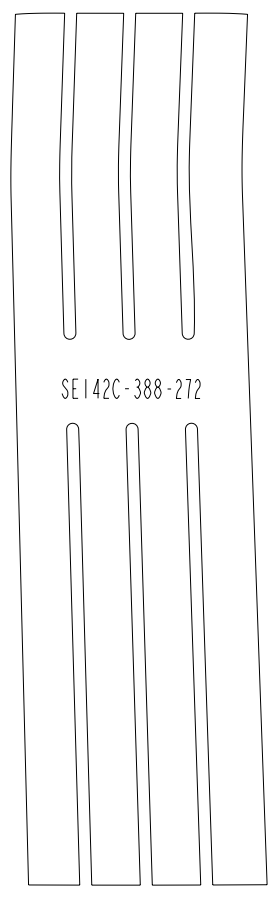

INSTANCE  
SE142C-388\_FLAT\_272

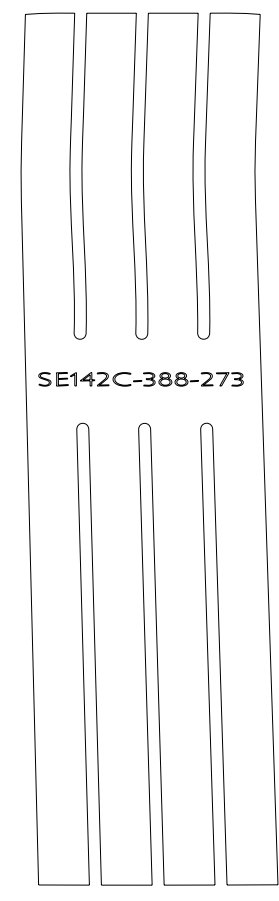

INSTANCE  
SE142C-388\_FLAT\_273

03

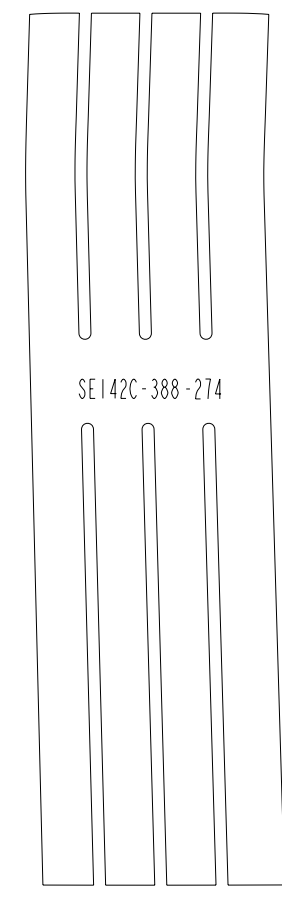

INSTANCE  
SE142C-388\_FLAT\_274

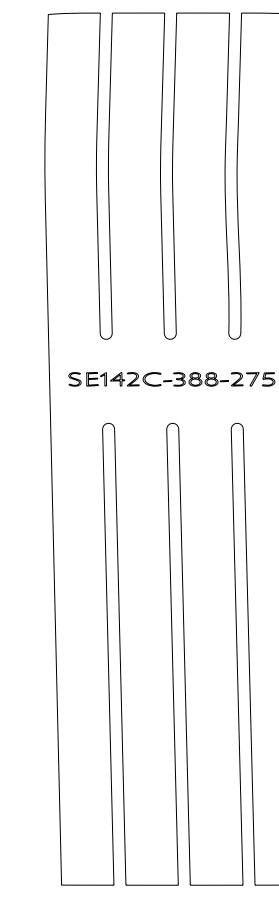

INSTANCE  
SE142C-388\_FLAT\_275

04

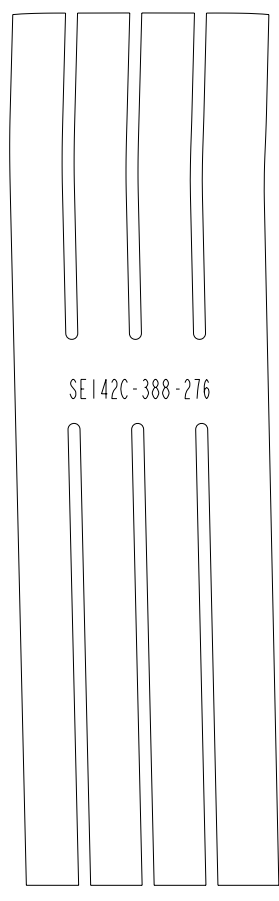

INSTANCE  
SE142C-388\_FLAT\_276



INSTANCE  
SE142C-388\_FLAT\_277

05

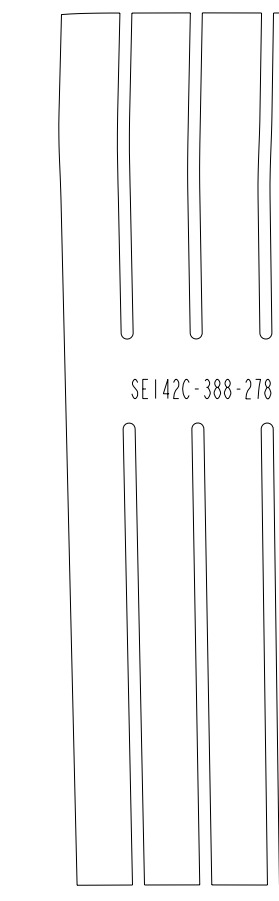

INSTANCE  
SE142C-388\_FLAT\_278

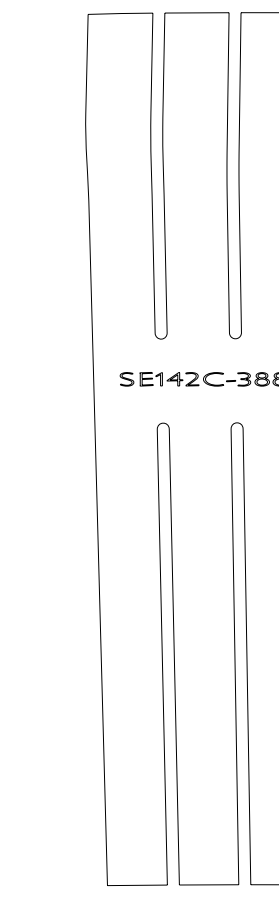

INSTANCE  
SE142C-388\_FLAT\_279

06

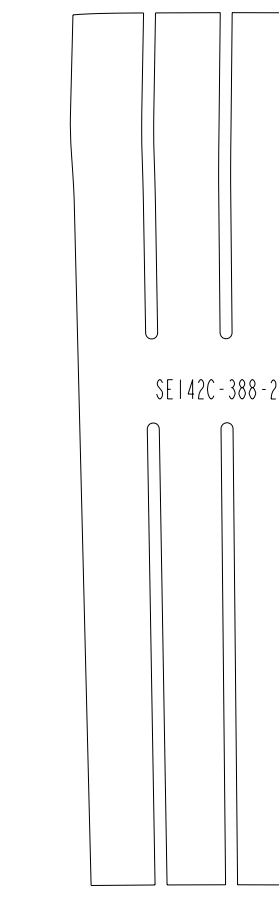

INSTANCE  
SE142C-388\_FLAT\_280

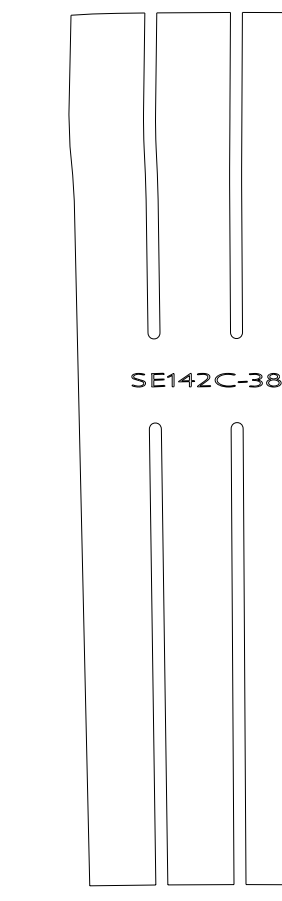

INSTANCE  
SE142C-388\_FLAT\_281

07

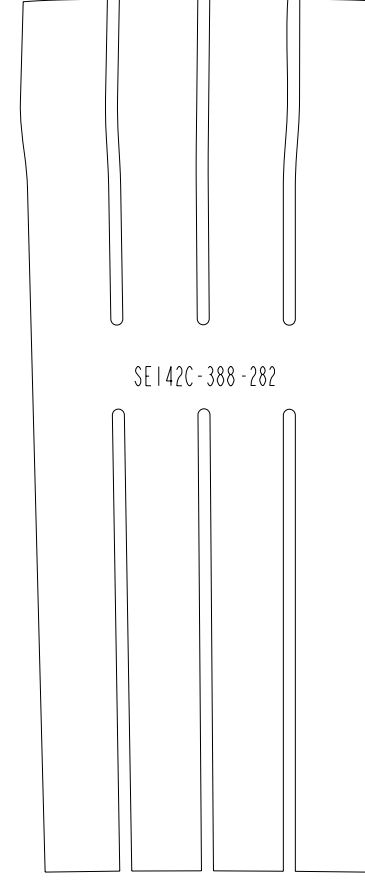

INSTANCE  
SE142C-388\_FLAT\_282

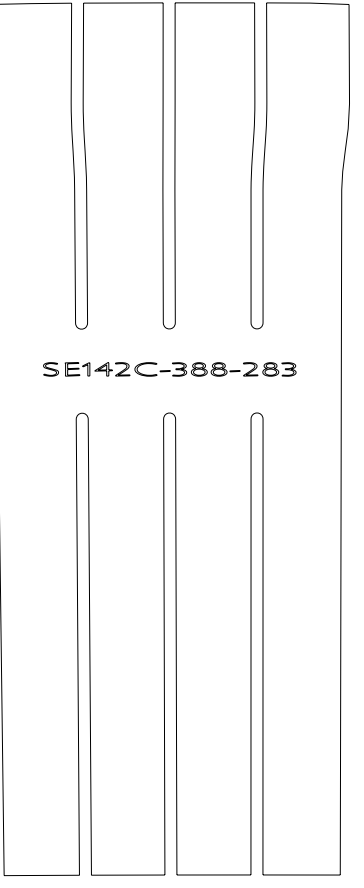

INSTANCE  
SE142C-388\_FLAT\_283

08

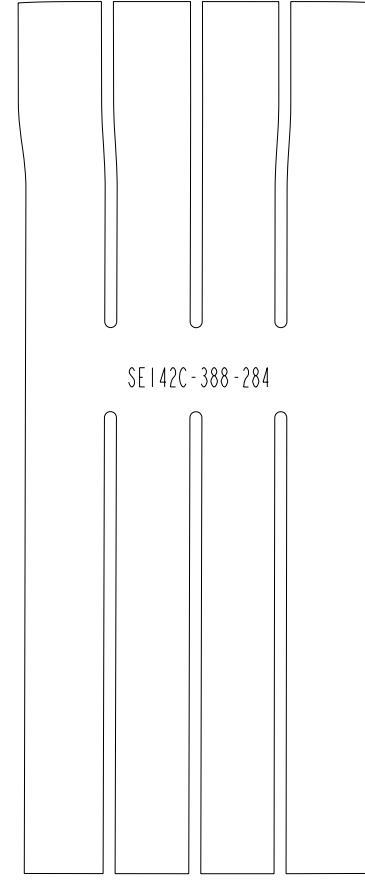

INSTANCE  
SE142C-388\_FLAT\_284

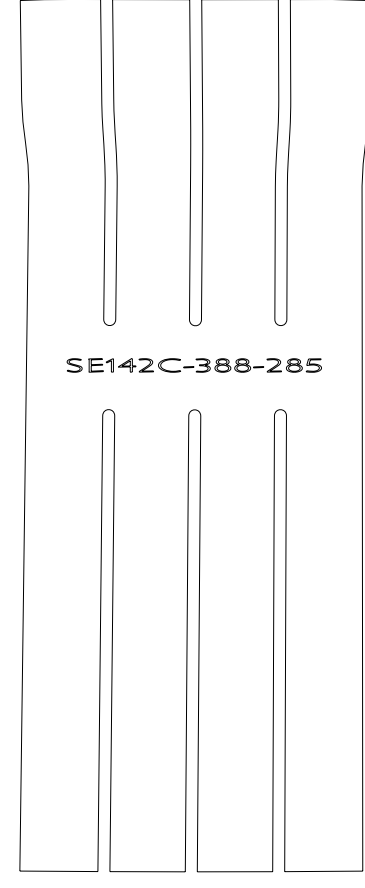

INSTANCE  
SE142C-388\_FLAT\_285

09

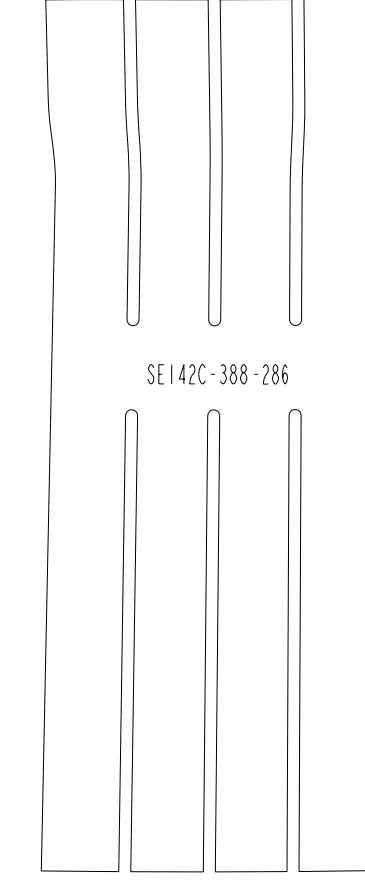

INSTANCE  
SE142C-388\_FLAT\_286

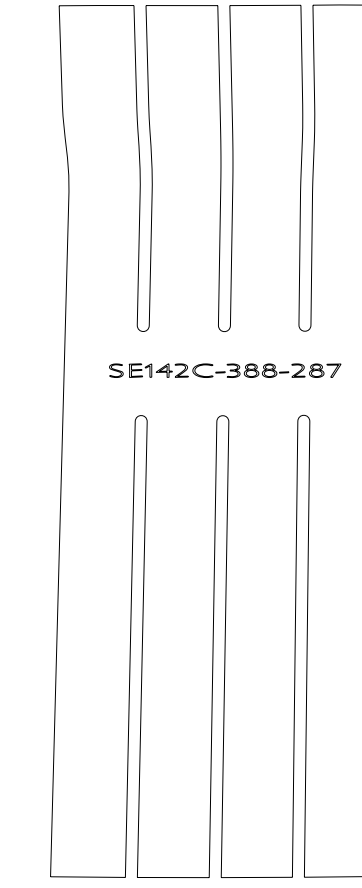

INSTANCE  
SE142C-388\_FLAT\_287

10

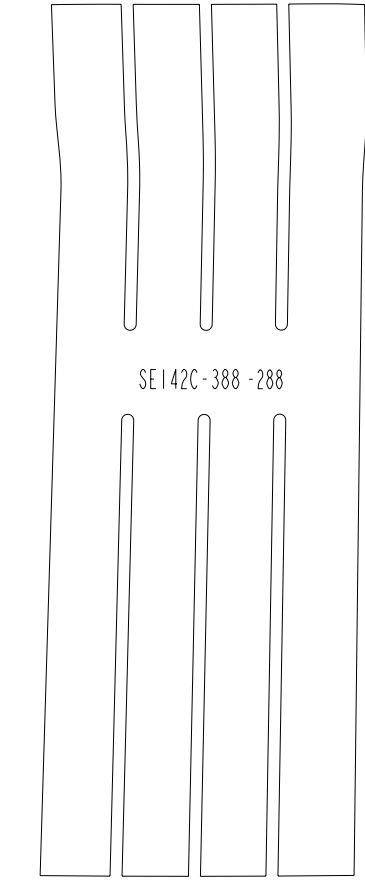

INSTANCE  
SE142C-388\_FLAT\_288

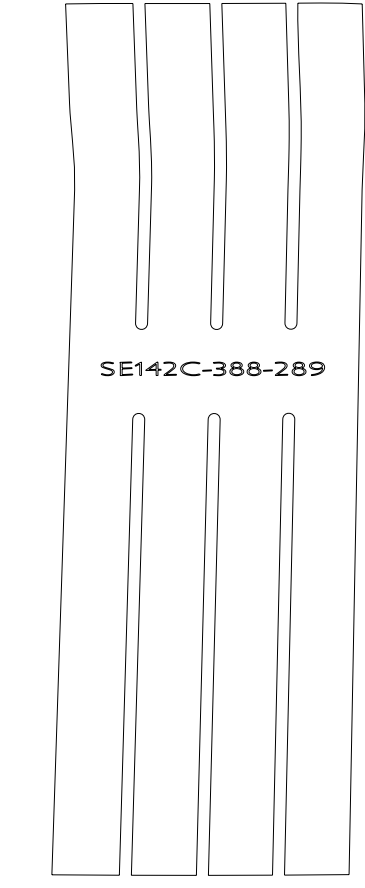

INSTANCE  
SE142C-388\_FLAT\_289

11

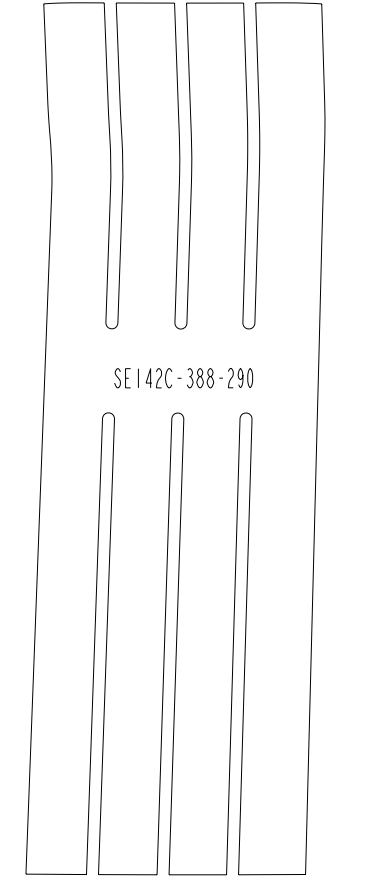

INSTANCE  
SE142C-388\_FLAT\_290

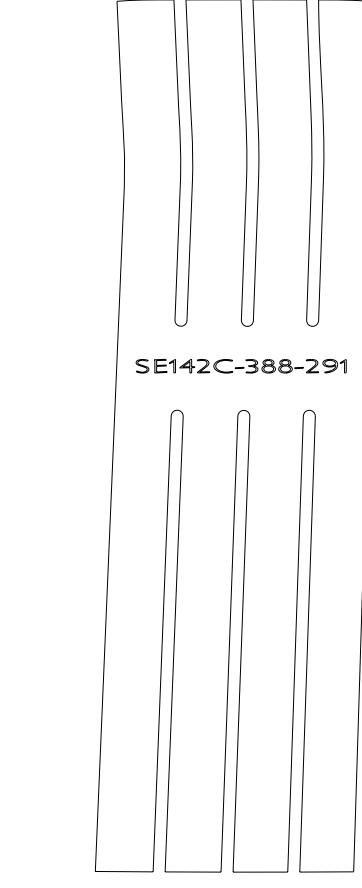

INSTANCE  
SE142C-388\_FLAT\_291

12

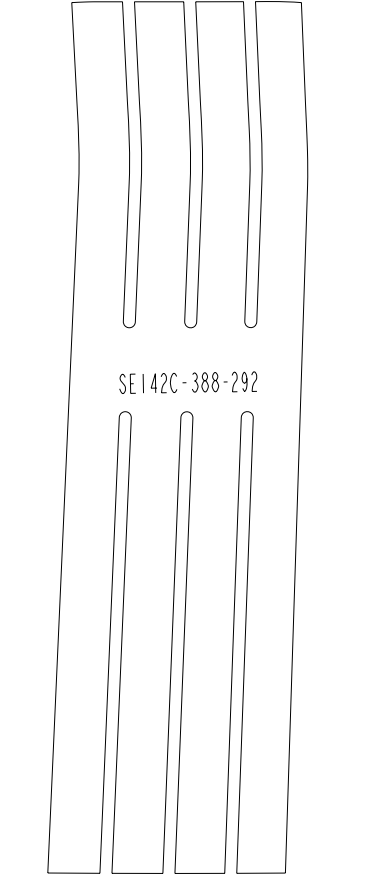

INSTANCE  
SE142C-388\_FLAT\_291\_NEW

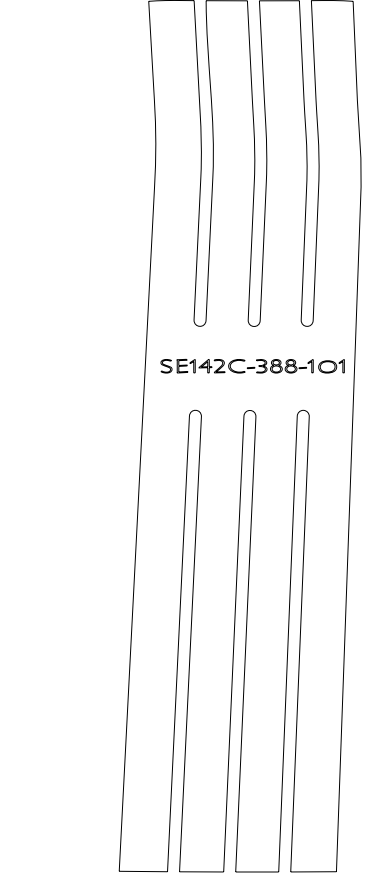

INSTANCE  
SE142C-388\_FLAT\_101

13

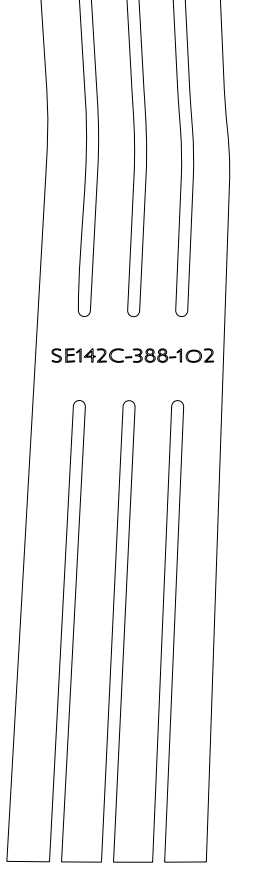

INSTANCE  
SE142C-388\_FLAT\_102

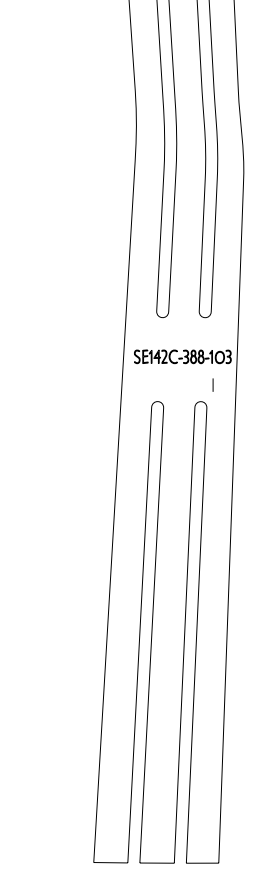

INSTANCE  
SE142C-388\_FLAT\_103-NEW

14

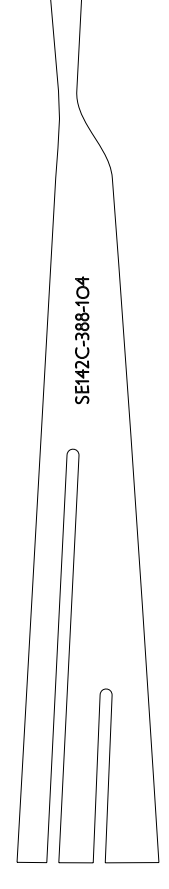

INSTANCE  
SE142C-388\_FLAT\_NEW\_104

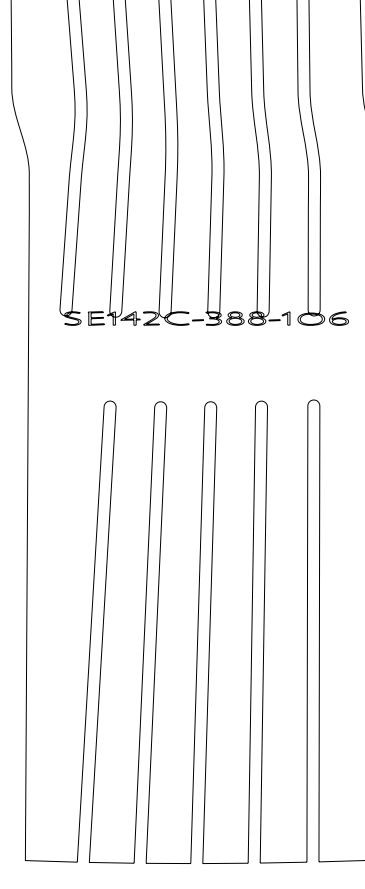

INSTANCE  
SE142C-388\_FLAT\_NEW\_106

15

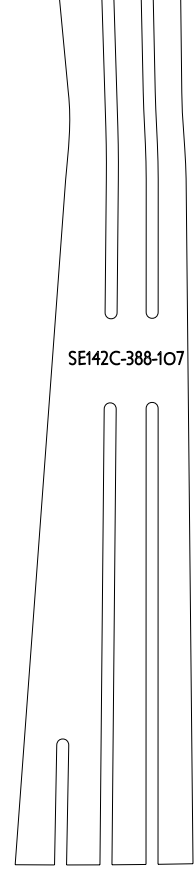

INSTANCE  
SE142C-388\_FLAT\_NEW\_107

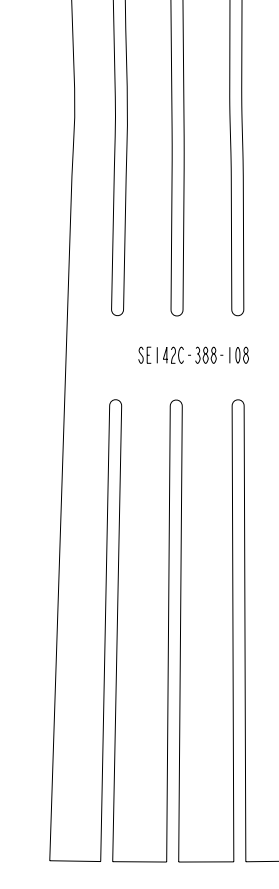

INSTANCE  
SE142C-388\_FLAT\_107-108

16

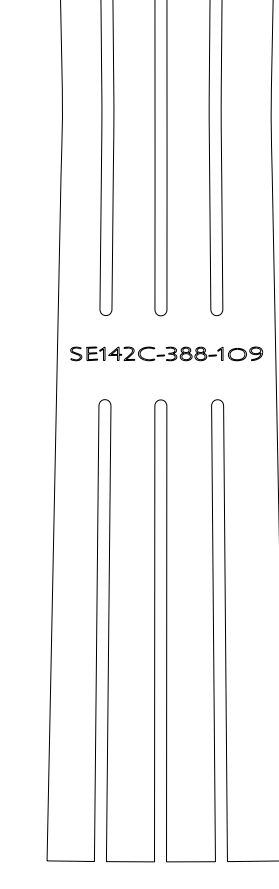

INSTANCE  
SE142C-388\_FLAT\_109

17

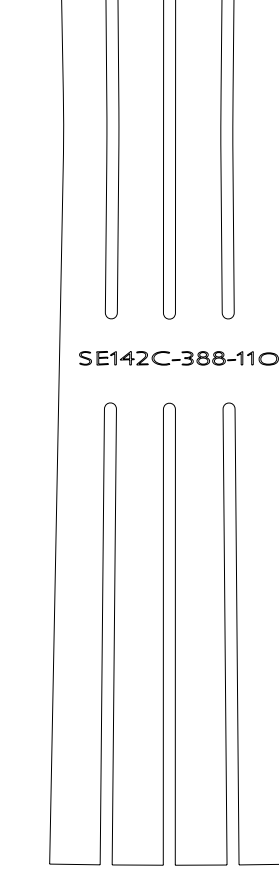

INSTANCE  
SE142C-388\_FLAT\_110

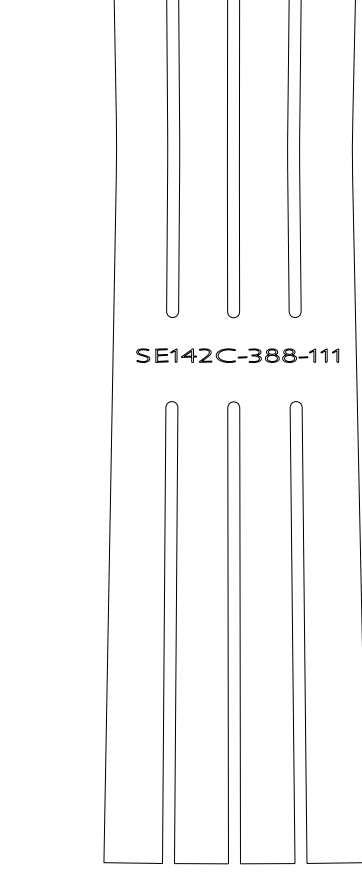

INSTANCE  
SE142C-388\_FLAT\_111

18

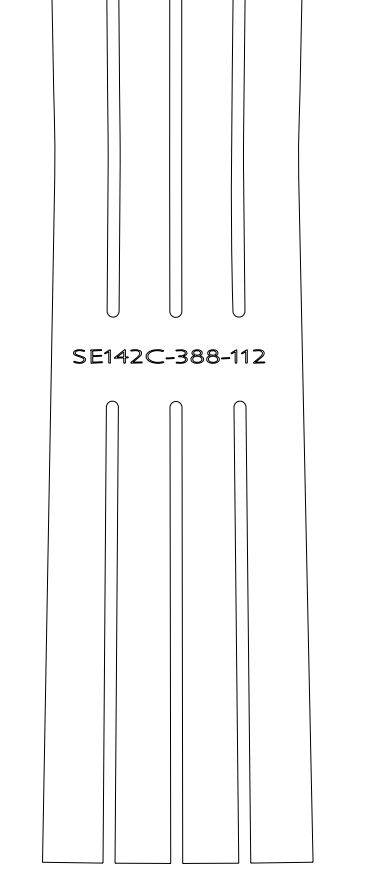

INSTANCE  
SE142C-388\_FLAT\_112

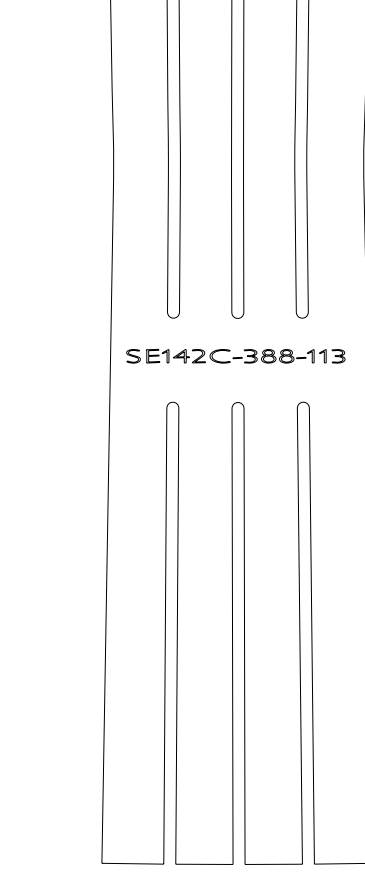

INSTANCE  
SE142C-388\_FLAT\_113

19

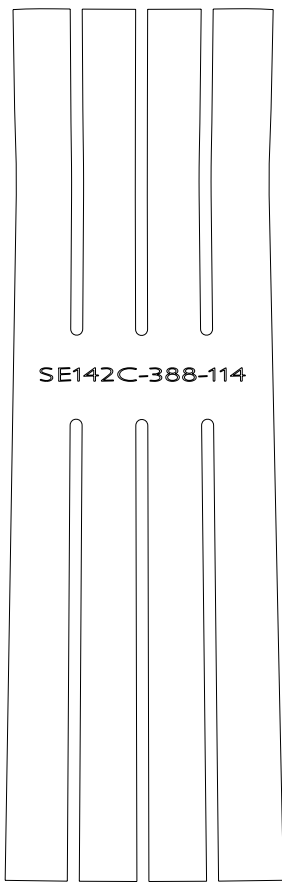

INSTANCE  
SE142C-388\_FLAT\_114

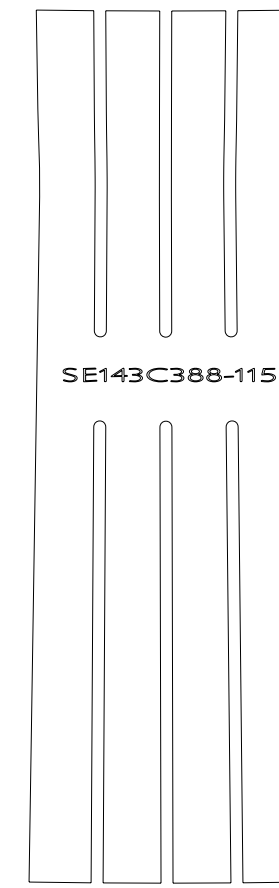

INSTANCE  
SE142C-388\_FLAT\_115

20

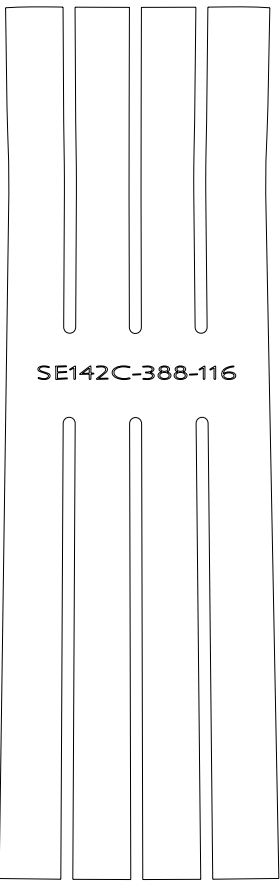

INSTANCE  
SE142C-388\_FLAT\_116

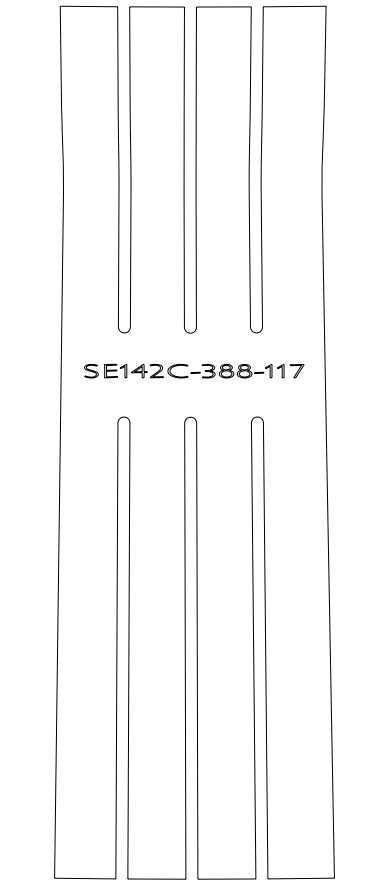

INSTANCE  
SE142C-388\_FLAT\_117

21

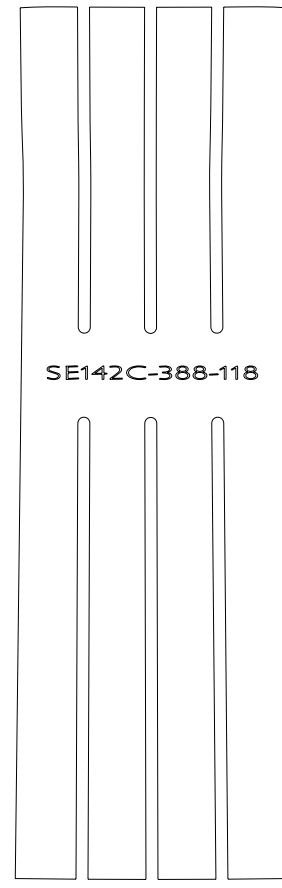

INSTANCE  
SE142C-388\_FLAT\_118

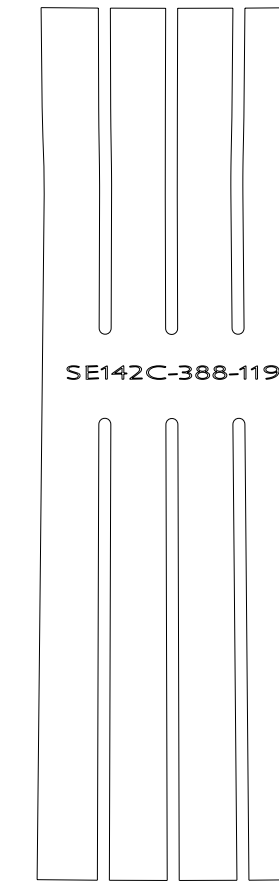

INSTANCE  
SE142C-388\_FLAT\_119

22

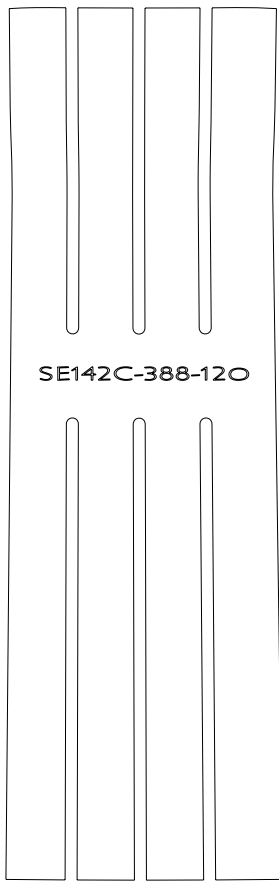

INSTANCE  
SE142C-388\_FLAT\_120

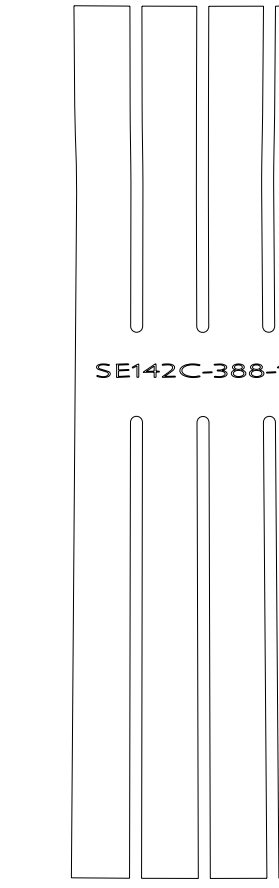

INSTANCE  
SE142C-388\_FLAT\_121

23

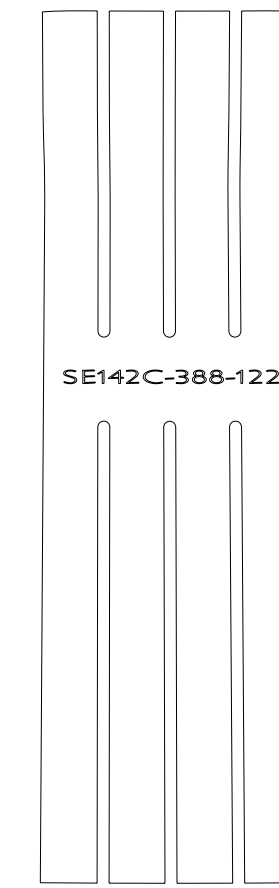

INSTANCE  
SE142C-388\_FLAT\_122

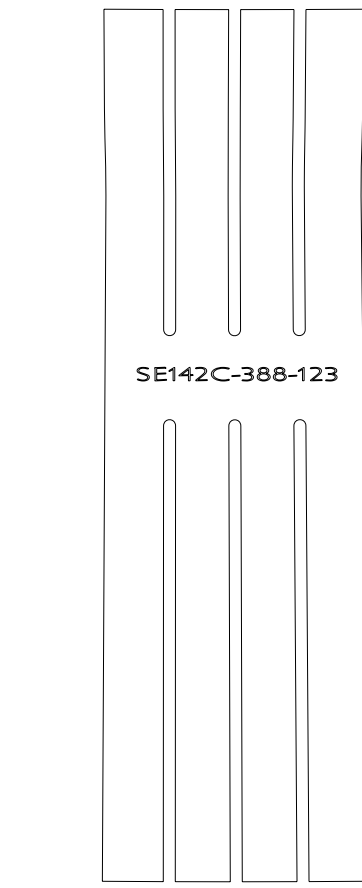

INSTANCE  
SE142C-388\_FLAT\_123

24

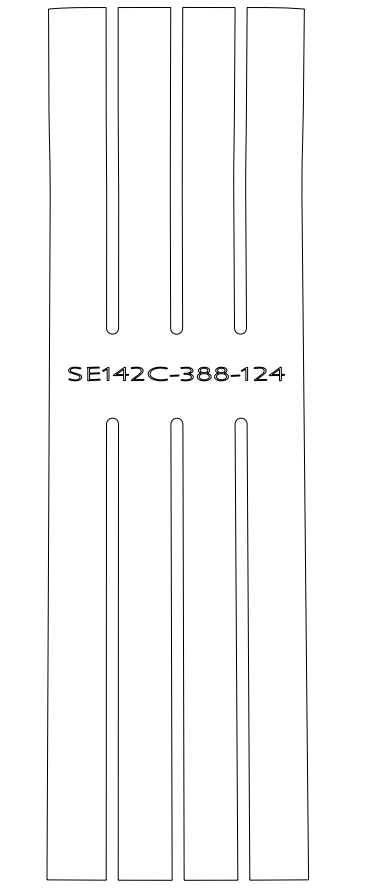

INSTANCE  
SE142C-388\_FLAT\_124

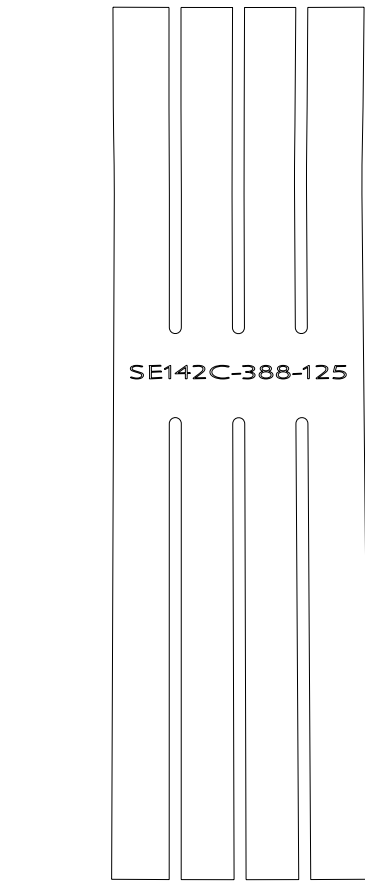

INSTANCE  
SE142C-388\_FLAT\_125

Oak Ridge National Laboratory  
managed for the DEPARTMENT OF ENERGY under  
U.S. GOVERNMENT CONTRACT DE-AC05-00OR22725  
UT-BATTELLE, LLC. Oak Ridge, Tennessee  
PROJECT NAME

**UT-BATTELLE**

**NATIONAL COMPACT STELLARATOR EXPERIMENT**  
MODULAR COIL TYPE - C  
SIDE "A" LOWER BOTTOM CHILL PLATE  
FLAT PATTERN LAYOUT

VERSION NO.	PLANT	BLDG	FL	SHT	OF	TYPE	CLASS
2	X-10	5700	3	2	5	S	U
RELEASE LEVEL		Fabrication		SE142C-388		REV 2	





Oak Ridge National Laboratory  
 managed for the DEPARTMENT OF ENERGY under  
 U.S. GOVERNMENT CONTRACT DE-AC05-00OR22725  
 UT-BATTELLE, LLC. Oak Ridge, Tennessee  
 PROJECT NAME

**UT-BATTELLE**

**NATIONAL COMPACT STELLARATOR EXPERIMENT**

MODULAR COIL TYPE - C  
 SIDE "A" LOWER BOTTOM CHILL PLATE  
 FLAT PATTERN LAYOUT

VERSION NO.	PLANT	BLDG	FL	SHT	OF	TYPE	CLASS
3+	X-10	5700	3	3	5	S	U
RELEASE LEVEL	SE142C-388						REV
WIP							2

SE142C-388

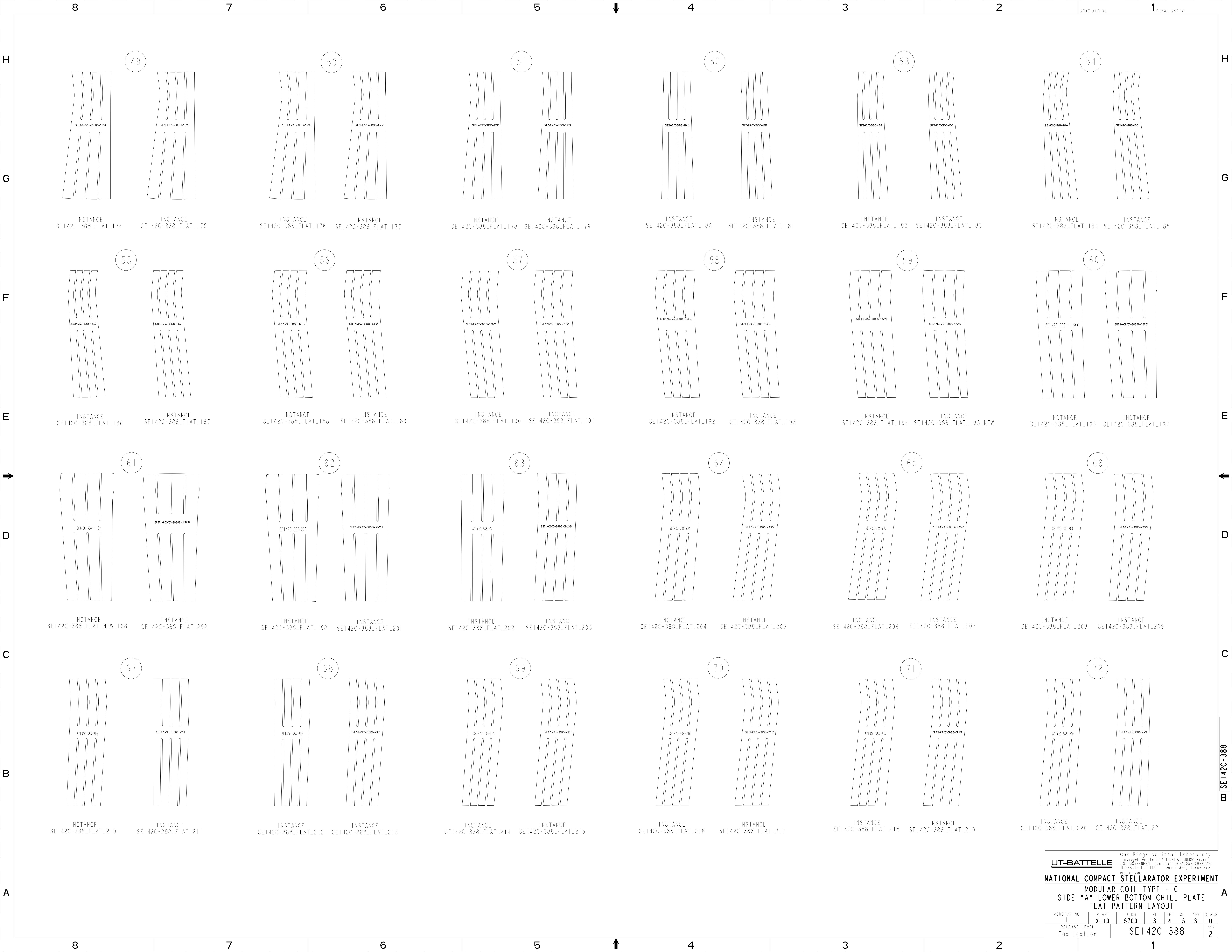

Oak Ridge National Laboratory managed for the DEPARTMENT OF ENERGY under U.S. GOVERNMENT CONTRACT DE-AC05-00OR22725 UT-BATTELLE, LLC. Oak Ridge, Tennessee PROJECT NAME									
<b>NATIONAL COMPACT STELLARATOR EXPERIMENT</b> MODULAR COIL TYPE - C SIDE "A" LOWER BOTTOM CHILL PLATE FLAT PATTERN LAYOUT									
VERSION NO.	PLANT	BLDG	FL	SHT	OF	TYPE	CLASS		
1	X-10	5700	3	4	5	S	U		
RELEASE LEVEL		SE142C-388						REV	
Fabrication								2	

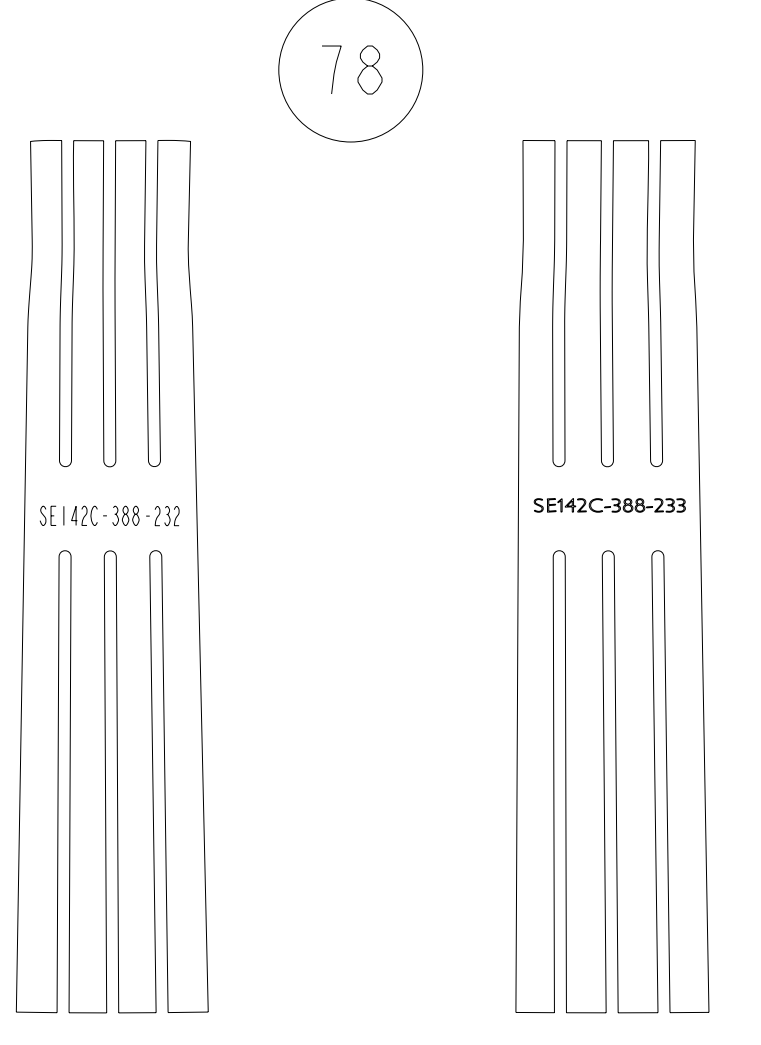

INSTANCE SE142C-388\_FLAT\_232 INSTANCE SE142C-388\_FLAT\_233

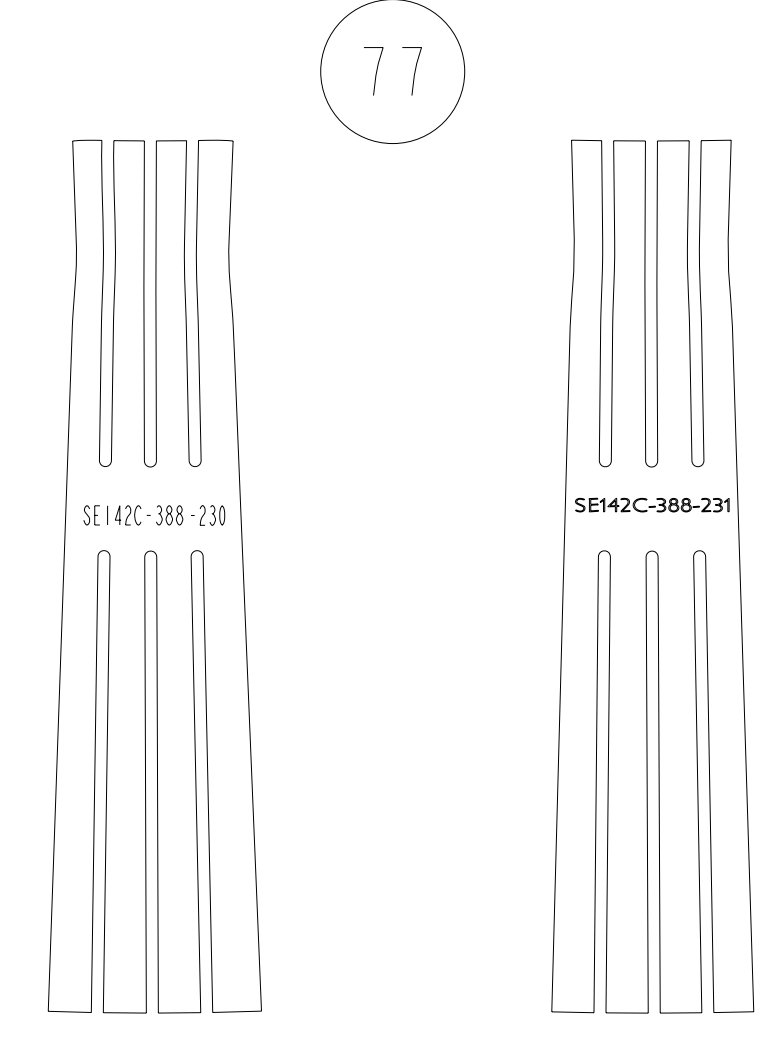

INSTANCE SE142C-388\_FLAT\_230 INSTANCE SE142C-388\_FLAT\_231

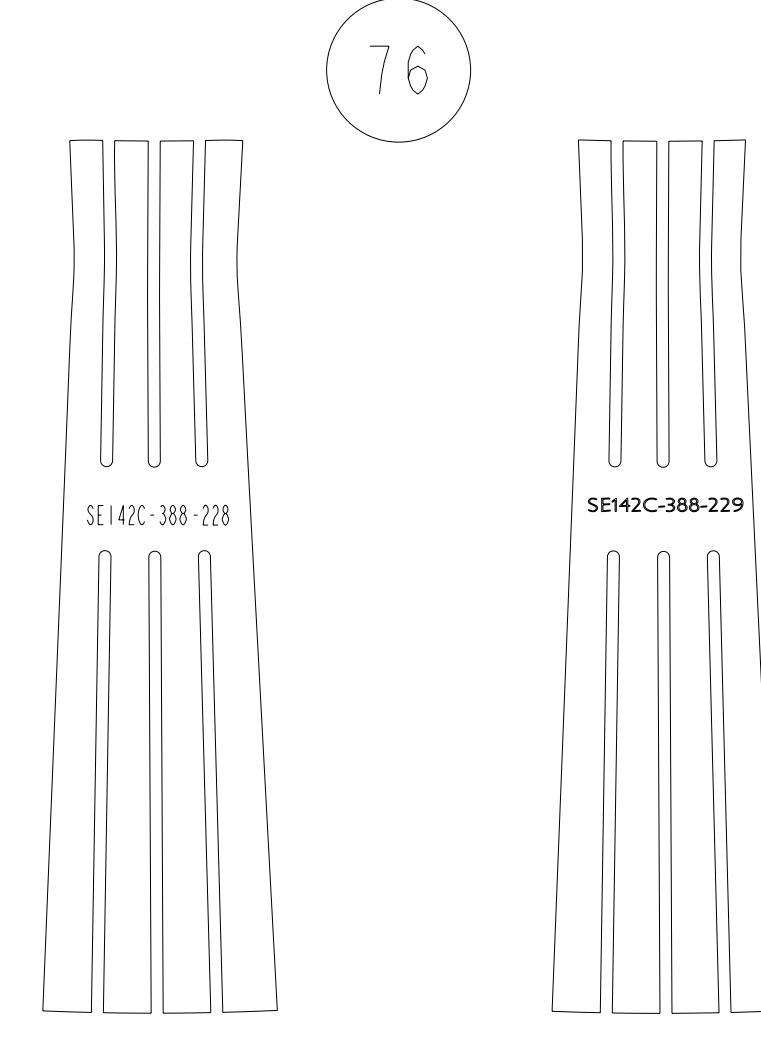

INSTANCE SE142C-388\_FLAT\_228 INSTANCE SE142C-388\_FLAT\_229

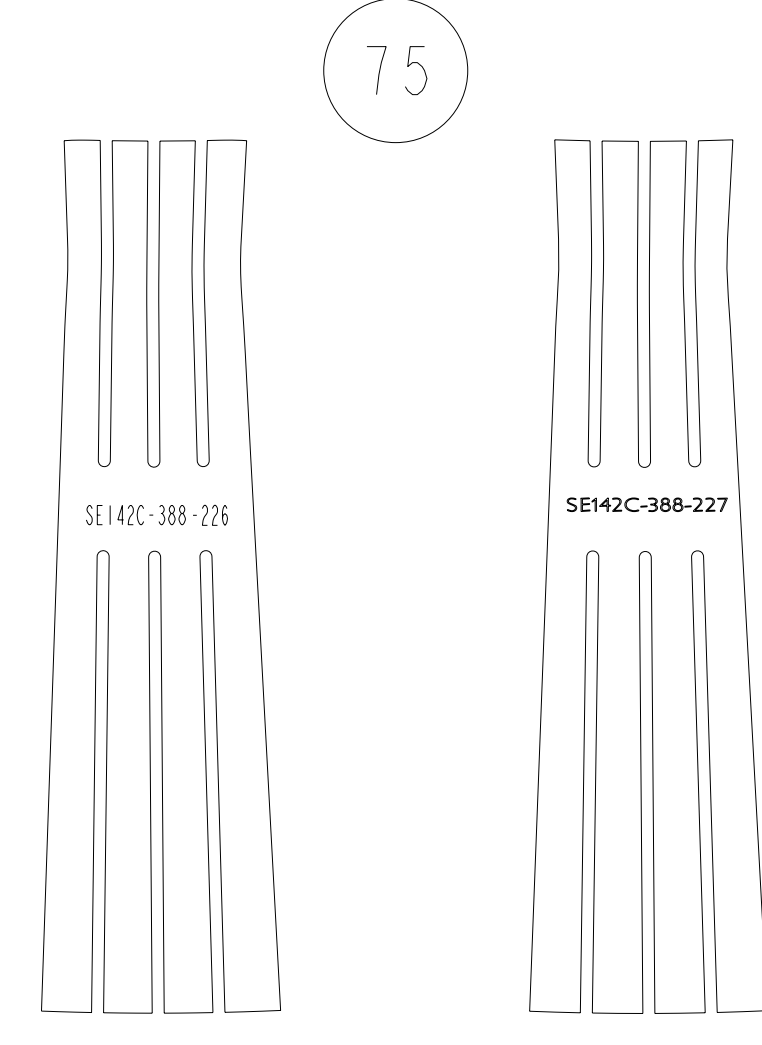

INSTANCE SE142C-388\_FLAT\_226 INSTANCE SE142C-388\_FLAT\_227

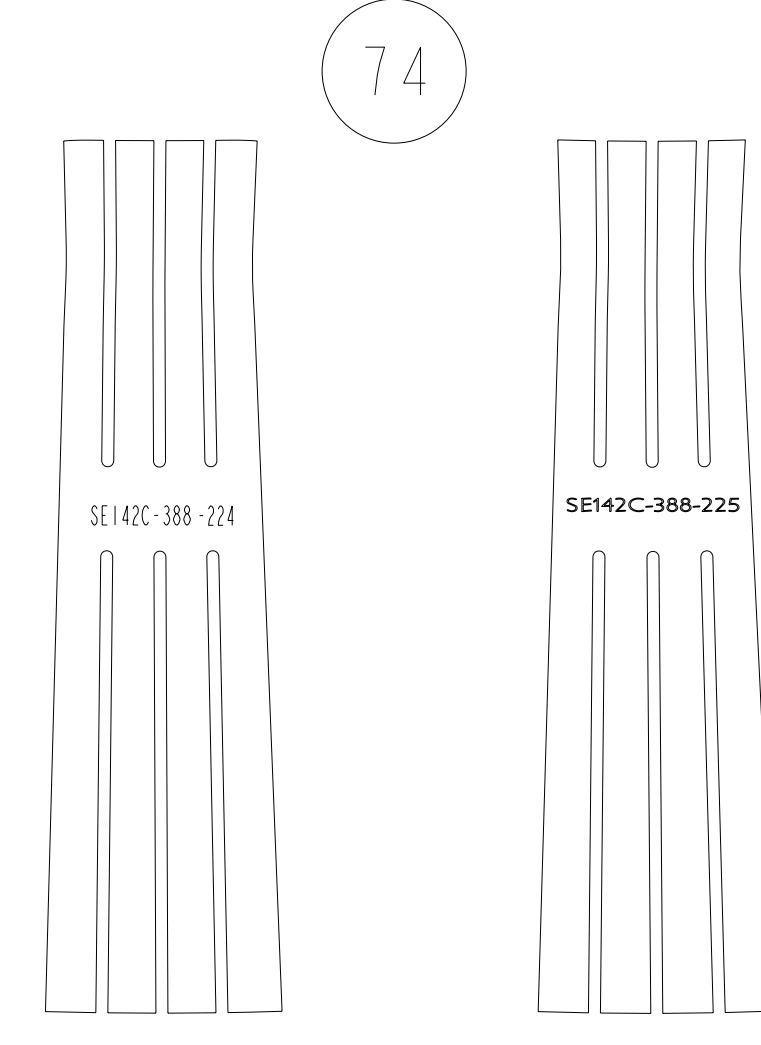

INSTANCE SE142C-388\_FLAT\_224 INSTANCE SE142C-388\_FLAT\_225

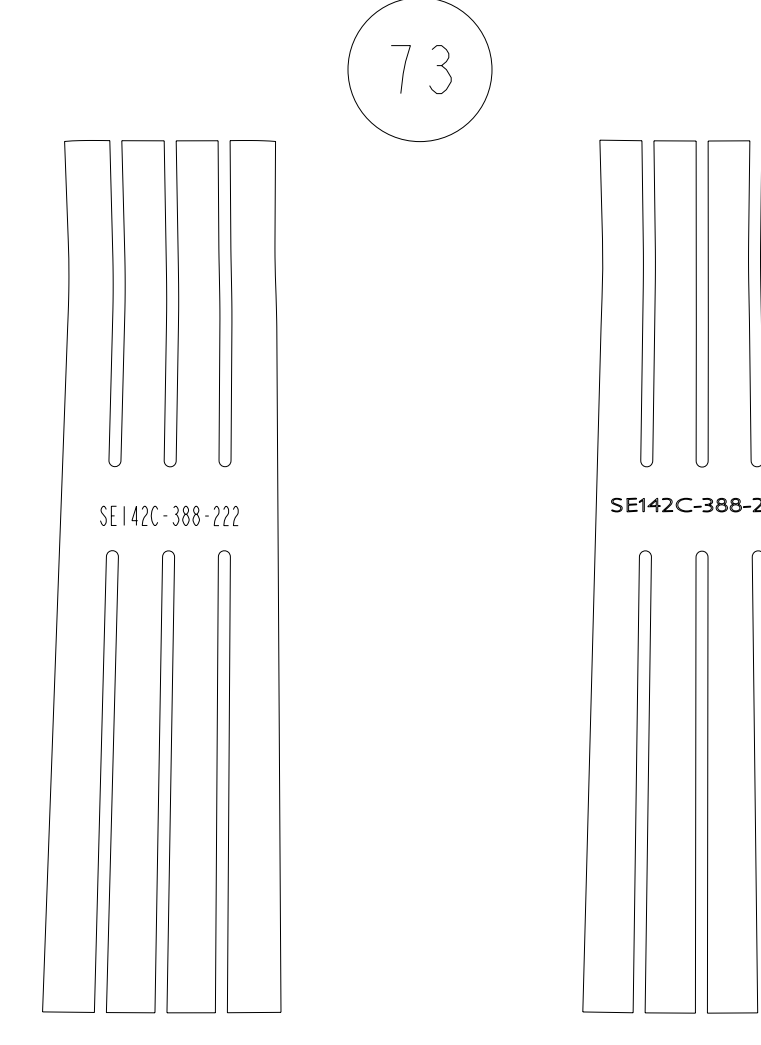

INSTANCE SE142C-388\_FLAT\_222 INSTANCE SE142C-388\_FLAT\_223

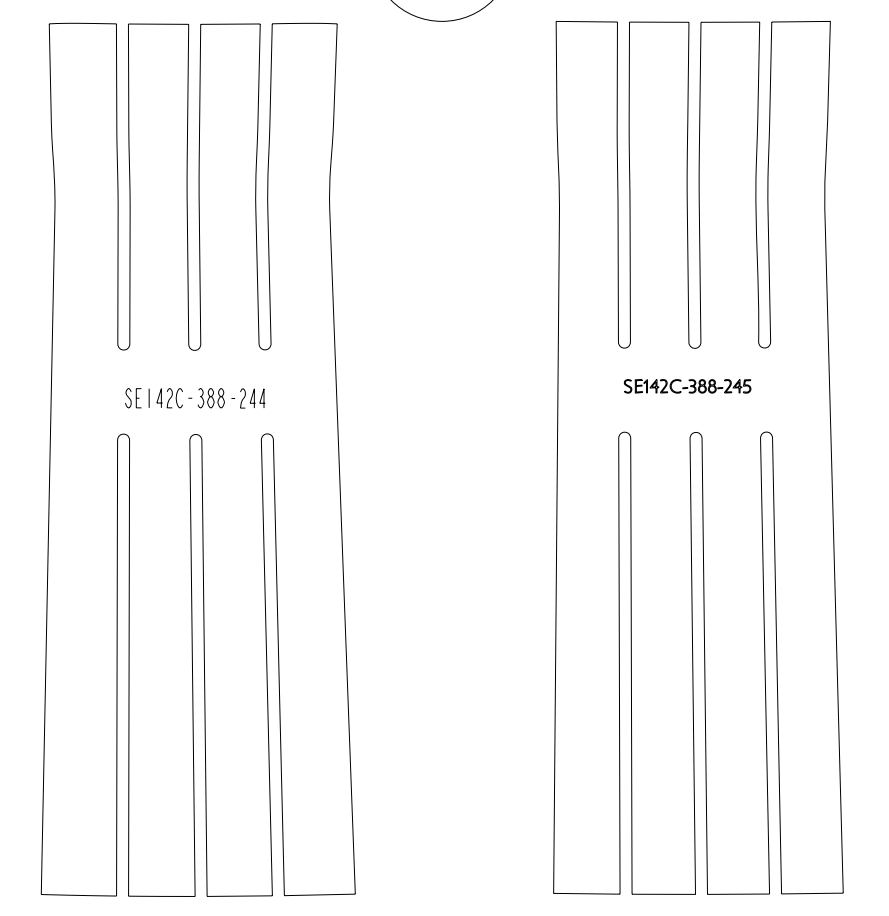

INSTANCE SE142C-388\_FLAT\_244 INSTANCE SE142C-388\_FLAT\_245

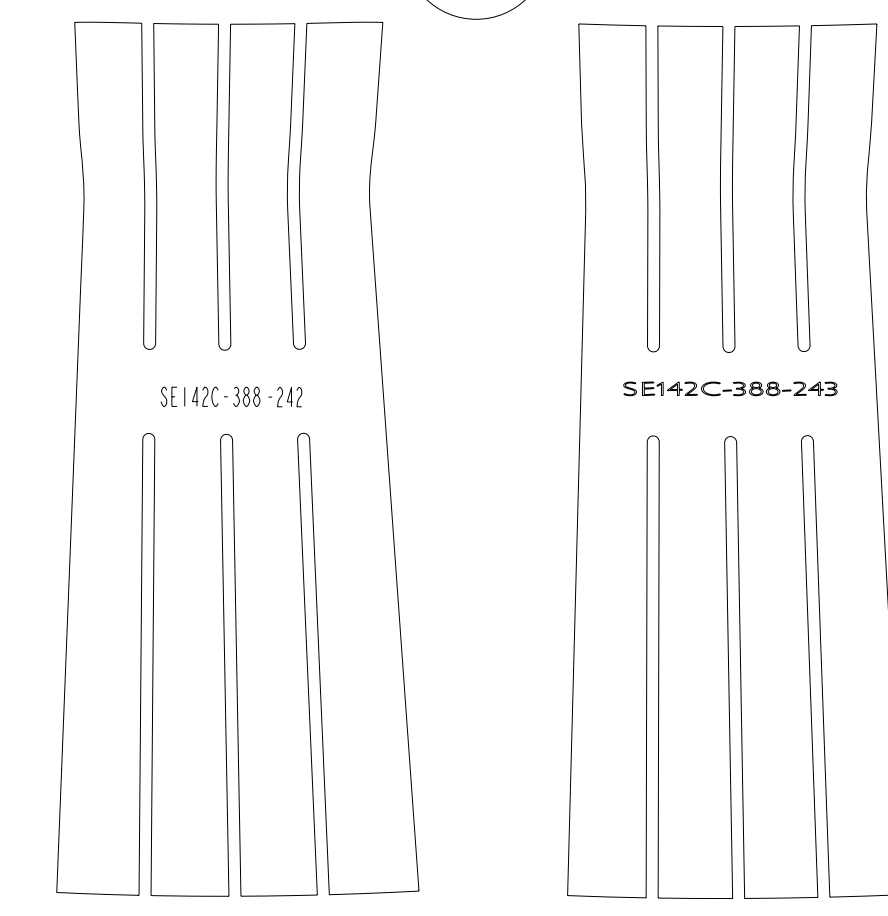

INSTANCE SE142C-388\_FLAT\_242 INSTANCE SE142C-388\_FLAT\_243

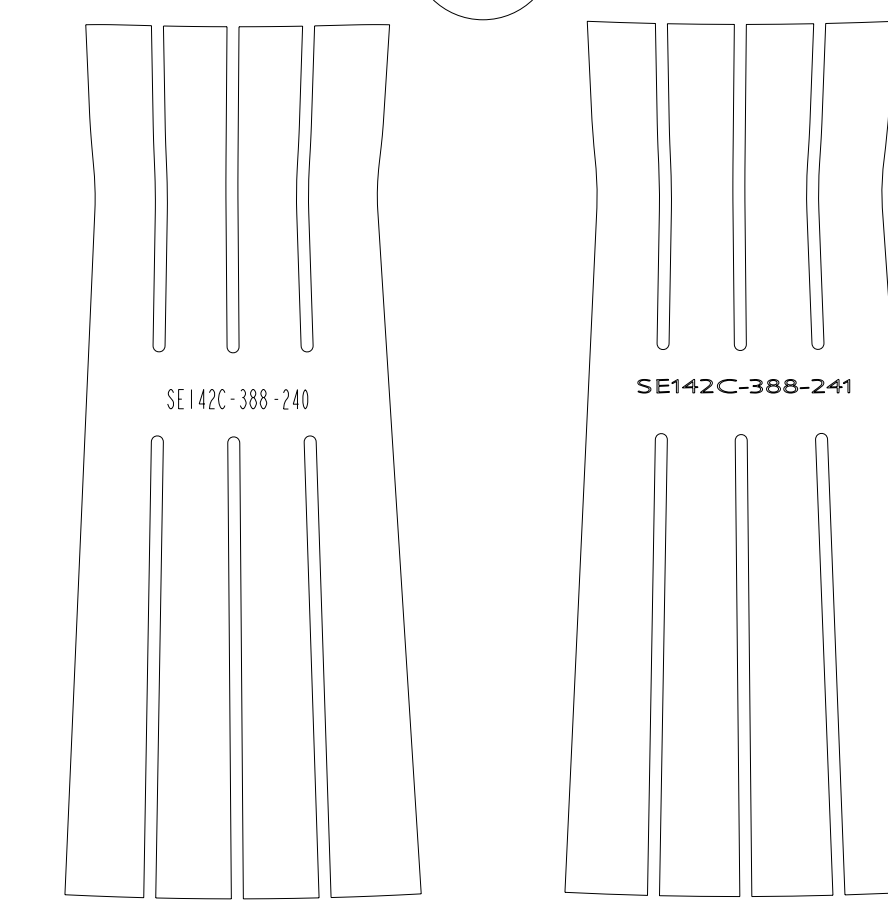

INSTANCE SE142C-388\_FLAT\_240 INSTANCE SE142C-388\_FLAT\_241

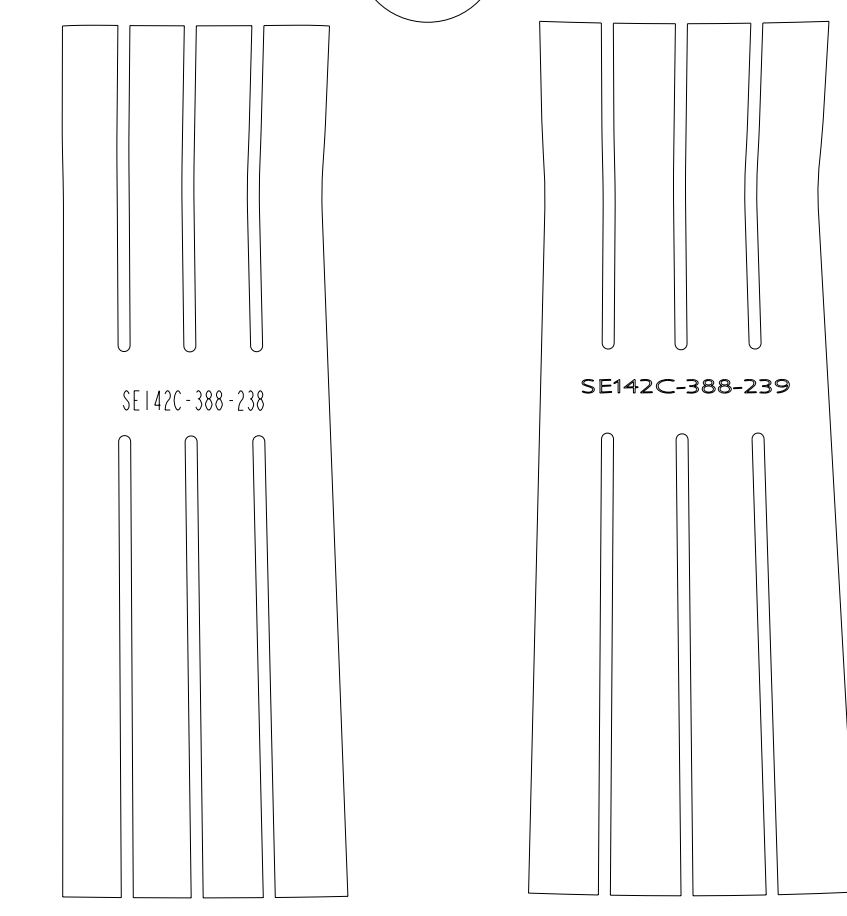

INSTANCE SE142C-388\_FLAT\_238 INSTANCE SE142C-388\_FLAT\_239

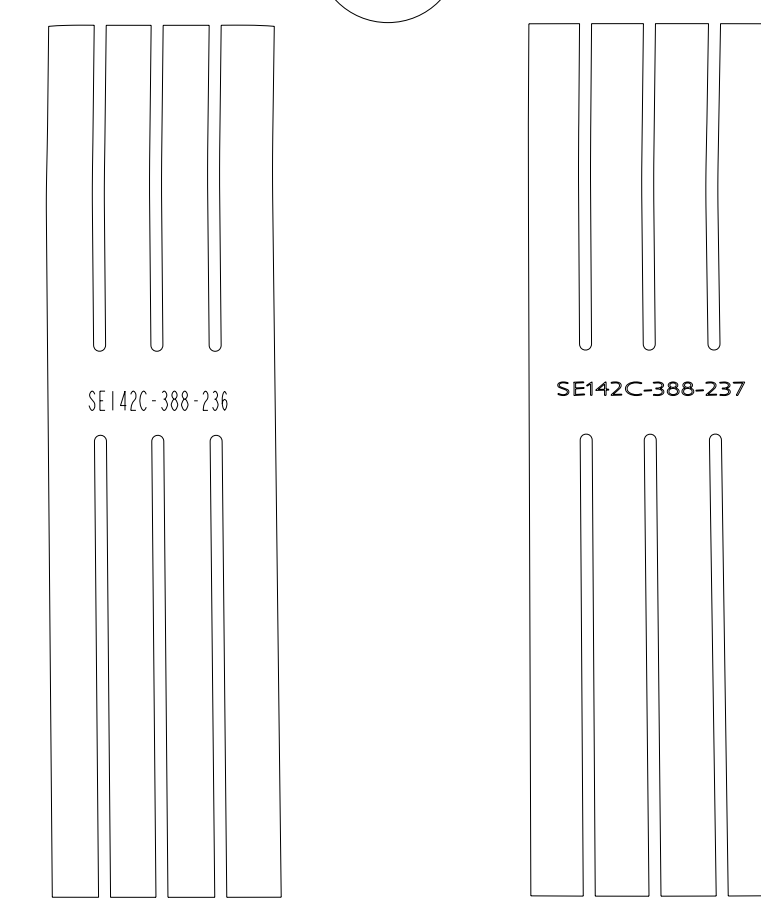

INSTANCE SE142C-388\_FLAT\_236 INSTANCE SE142C-388\_FLAT\_237

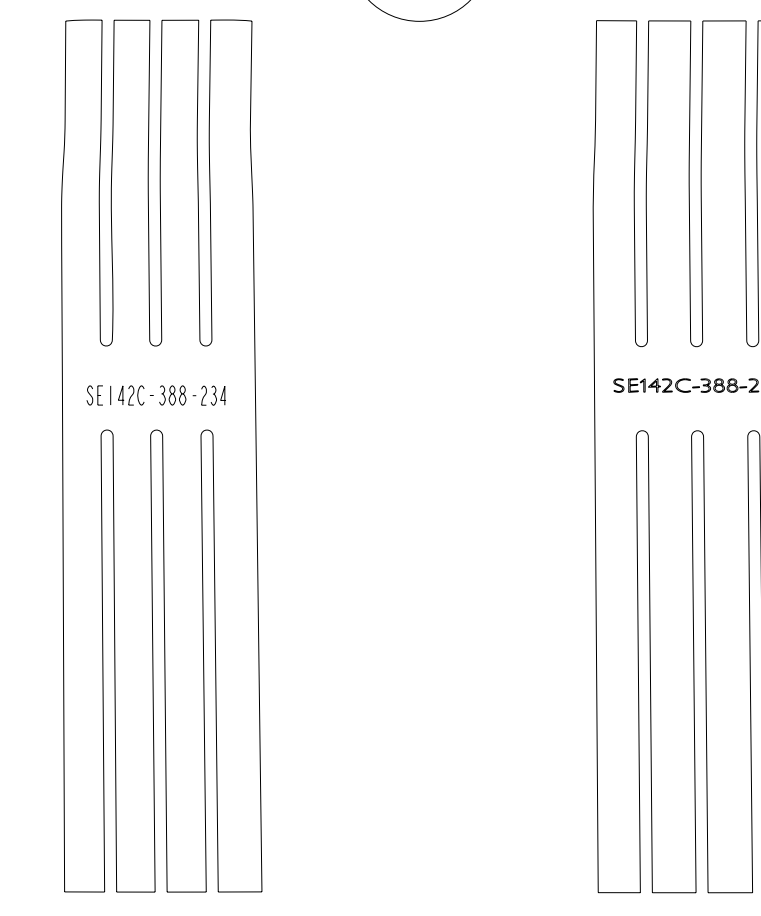

INSTANCE SE142C-388\_FLAT\_234 INSTANCE SE142C-388\_FLAT\_235

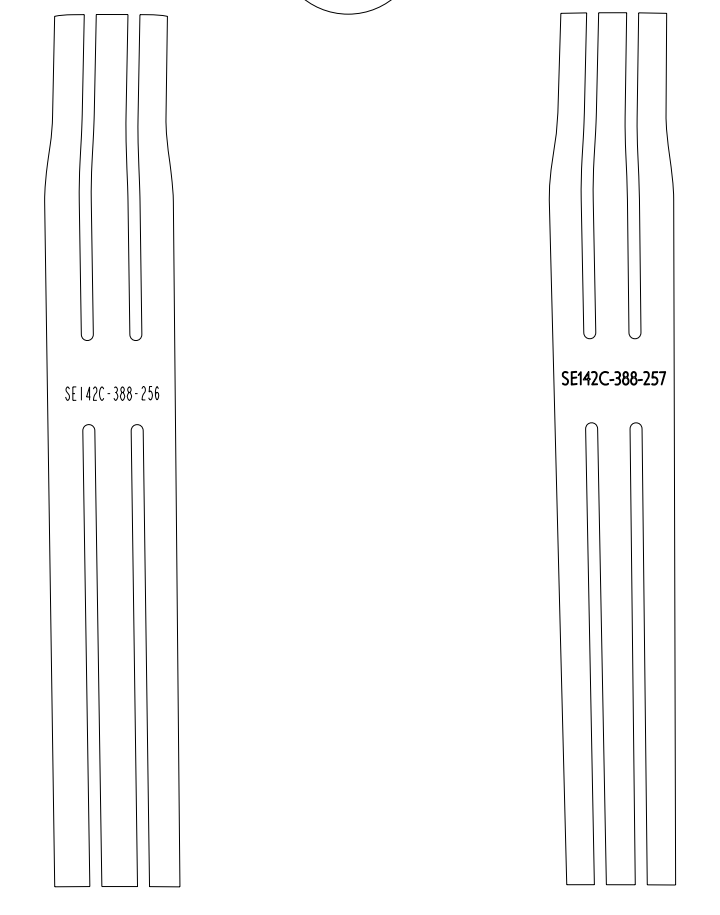

INSTANCE SE142C-388\_FLAT\_NEW\_256 INSTANCE SE142C-388\_FLAT\_NEW\_257

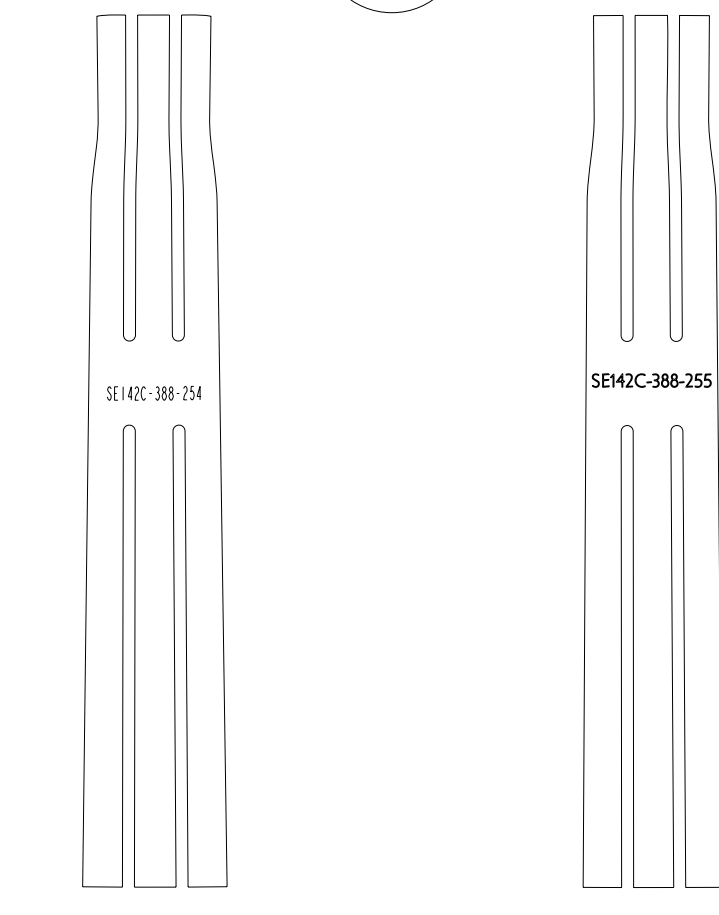

INSTANCE SE142C-388\_FLAT\_NEW\_254 INSTANCE SE142C-388\_FLAT\_NEW\_255

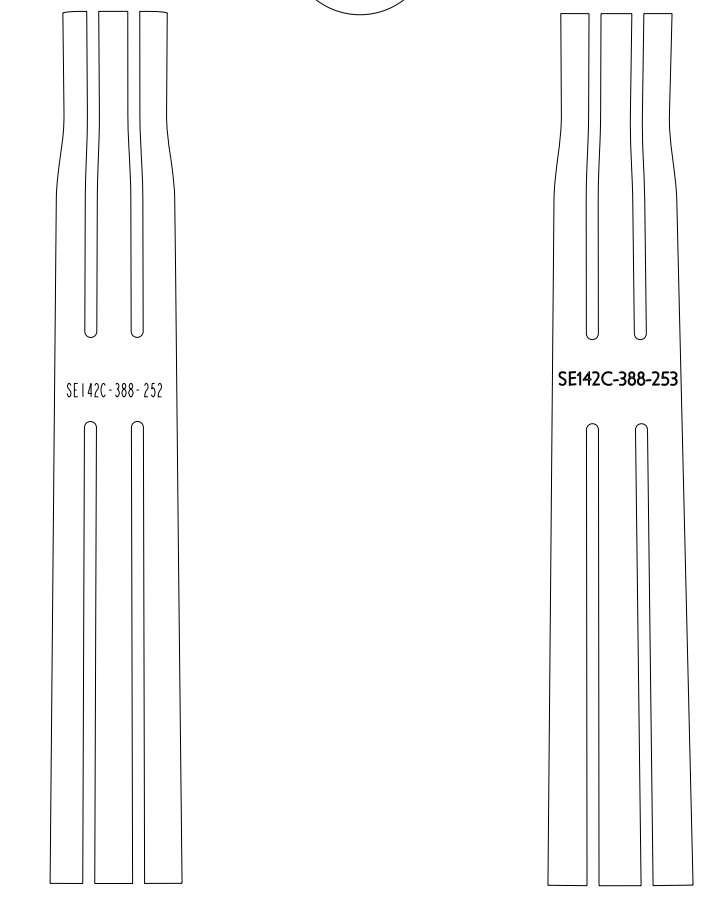

INSTANCE SE142C-388\_FLAT\_NEW\_252 INSTANCE SE142C-388\_FLAT\_NEW\_253

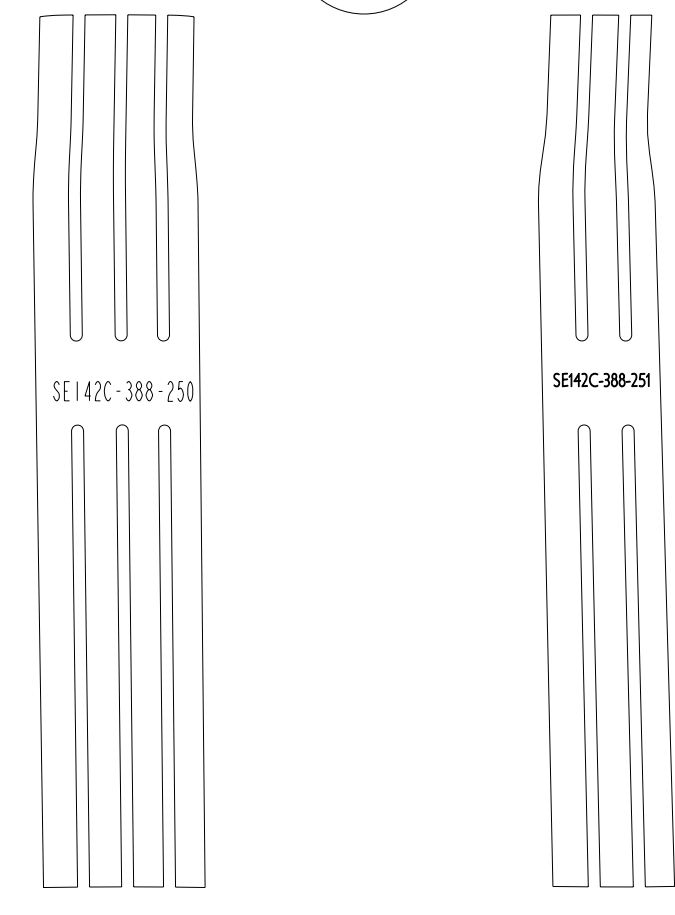

INSTANCE SE142C-388\_FLAT\_250 INSTANCE SE142C-388\_FLAT\_NEW\_251

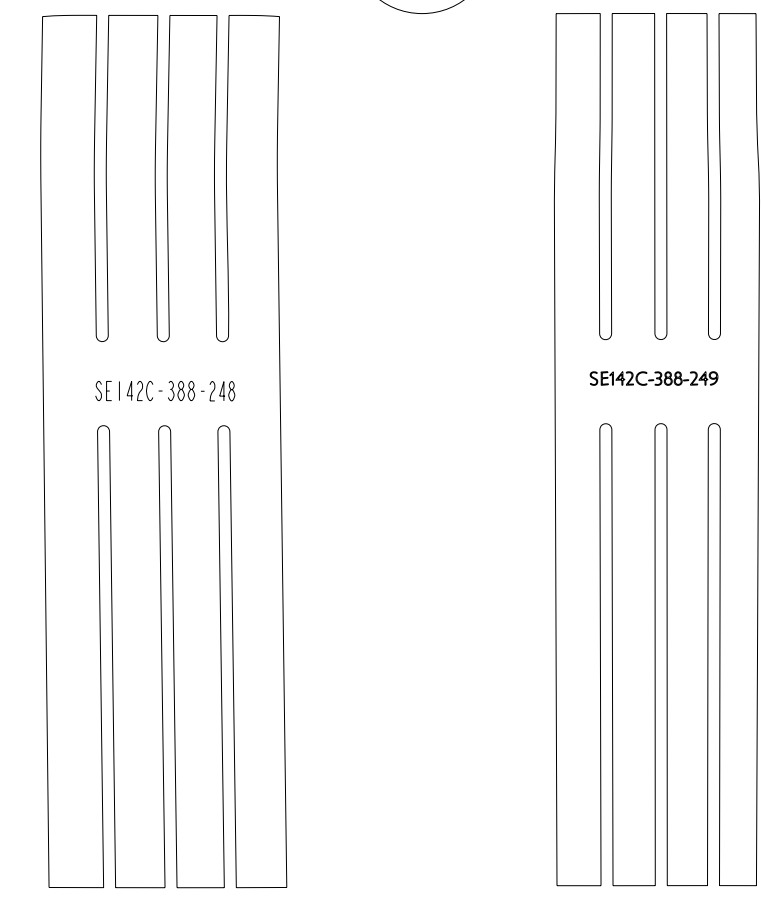

INSTANCE SE142C-388\_FLAT\_248 INSTANCE SE142C-388\_FLAT\_249

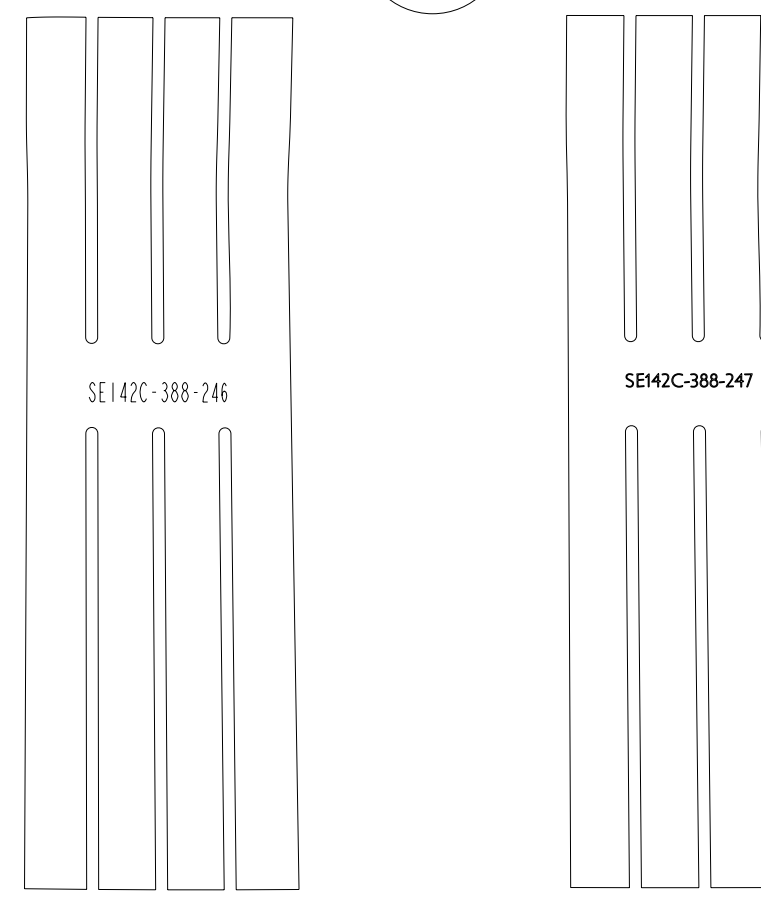

INSTANCE SE142C-388\_FLAT\_246 INSTANCE SE142C-388\_FLAT\_247

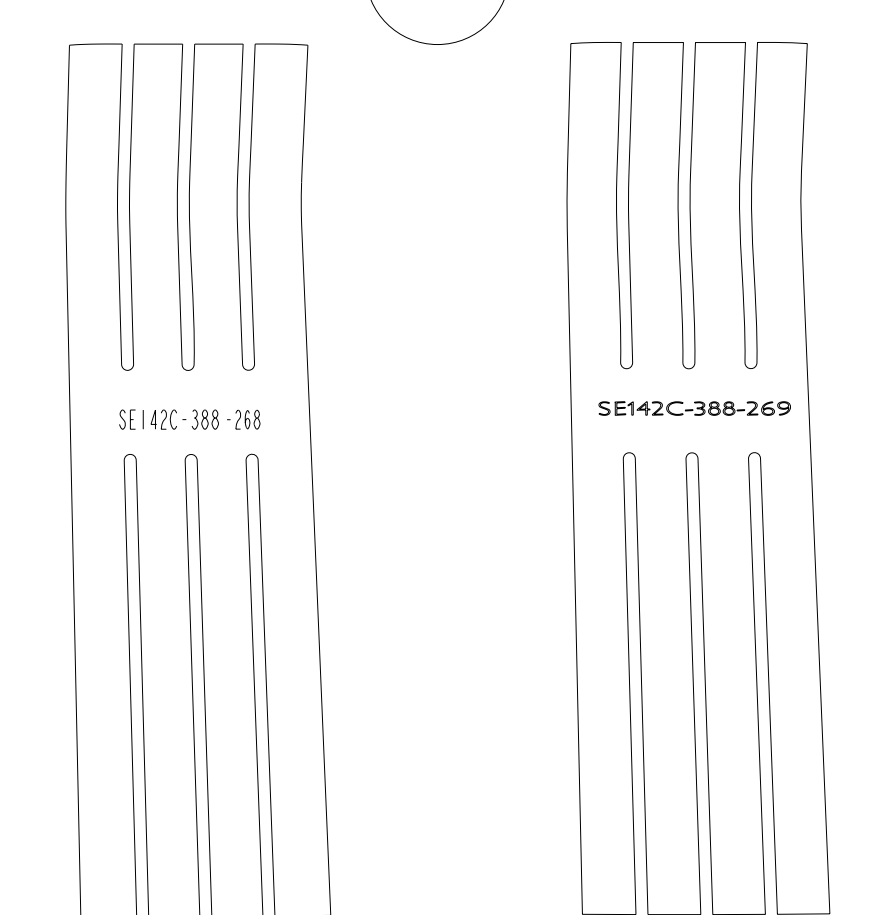

INSTANCE SE142C-388\_FLAT\_268 INSTANCE SE142C-388\_FLAT\_269

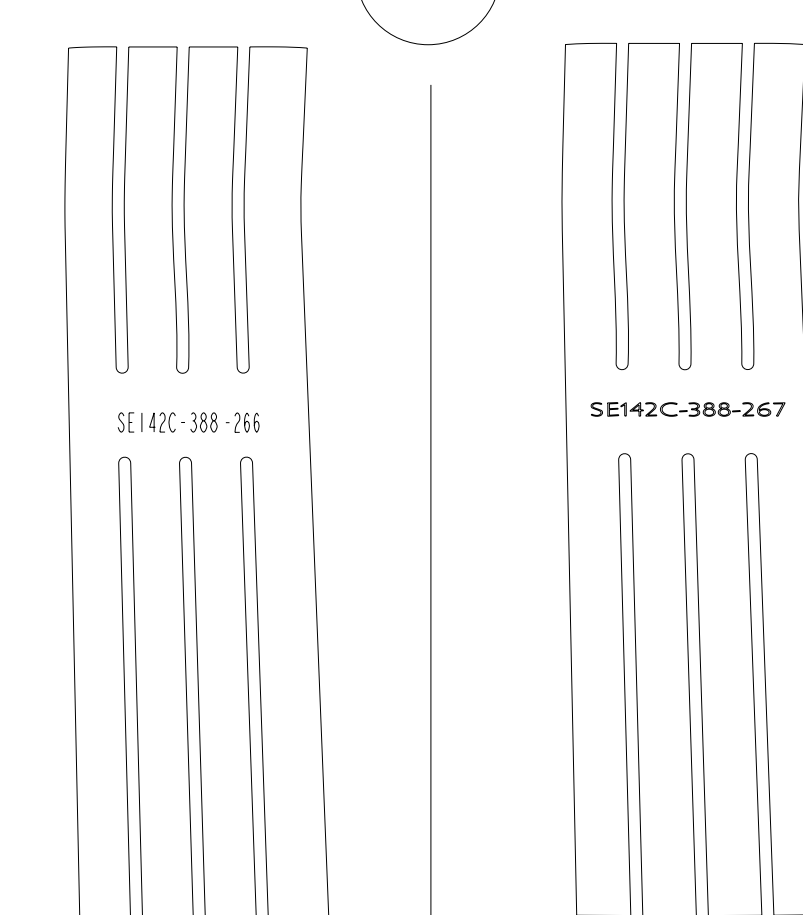

INSTANCE SE142C-388\_FLAT\_266 INSTANCE SE142C-388\_FLAT\_267

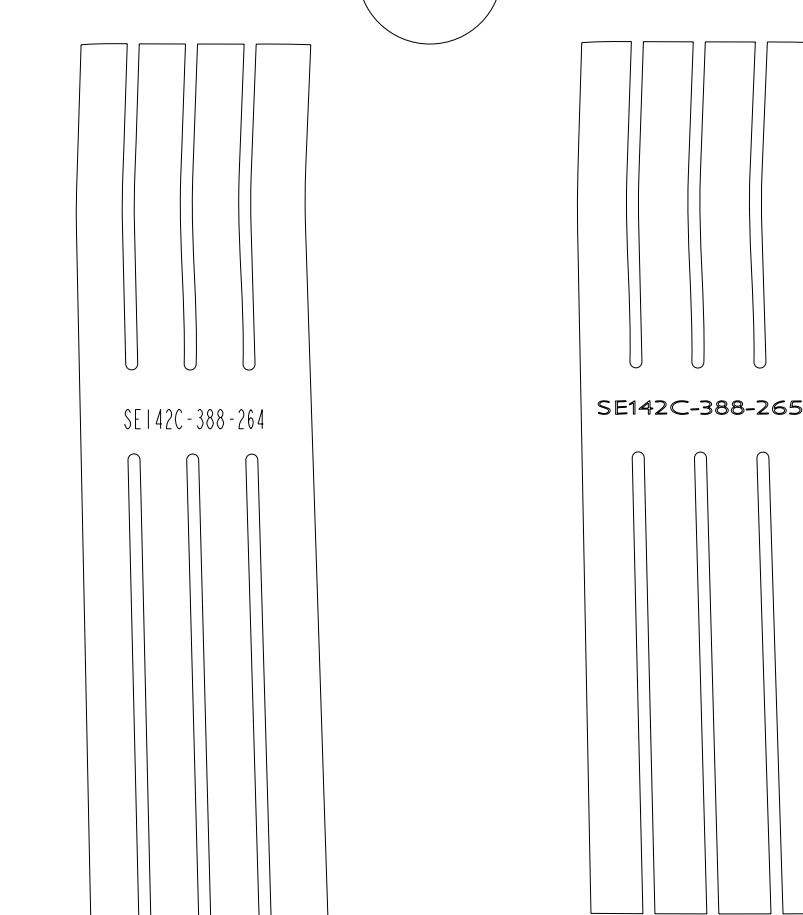

INSTANCE SE142C-388\_FLAT\_264 INSTANCE SE142C-388\_FLAT\_265

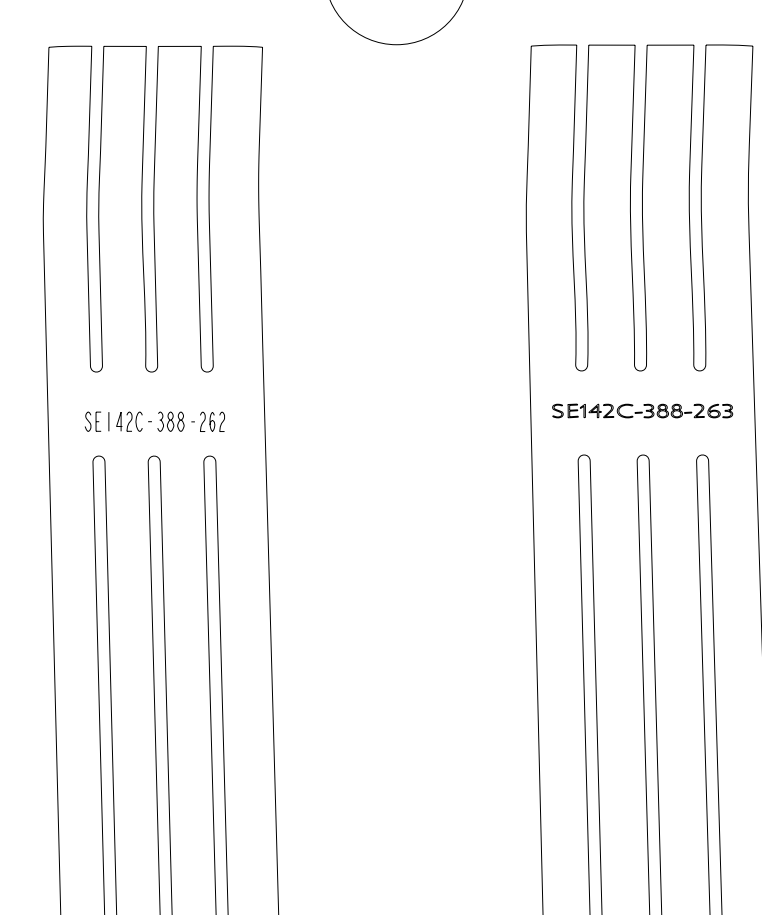

INSTANCE SE142C-388\_FLAT\_262 INSTANCE SE142C-388\_FLAT\_263

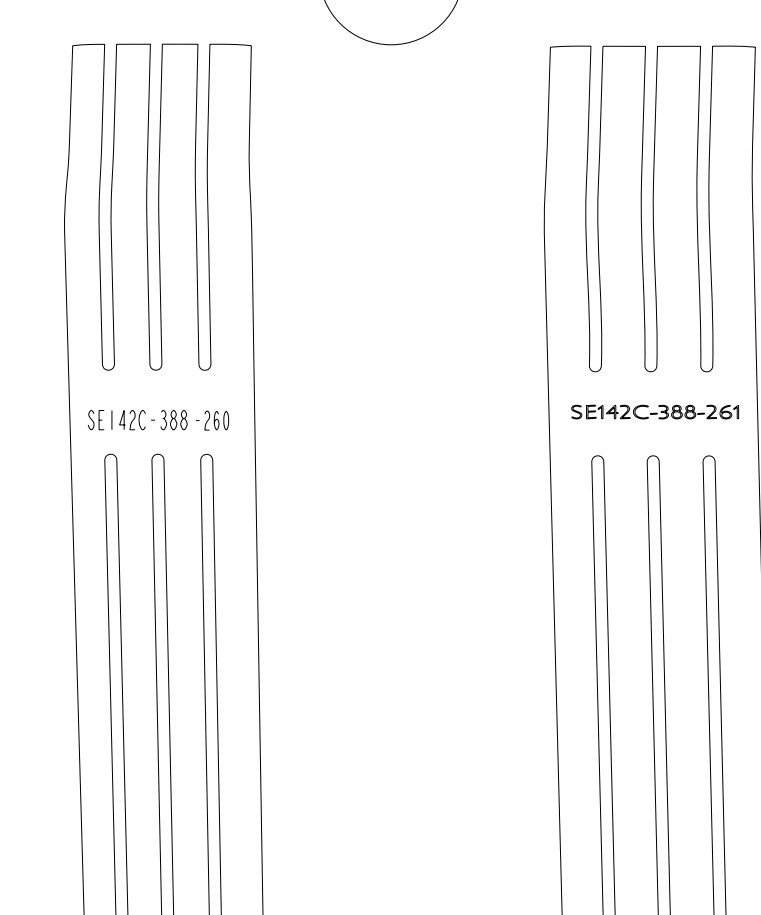

INSTANCE SE142C-388\_FLAT\_260 INSTANCE SE142C-388\_FLAT\_261

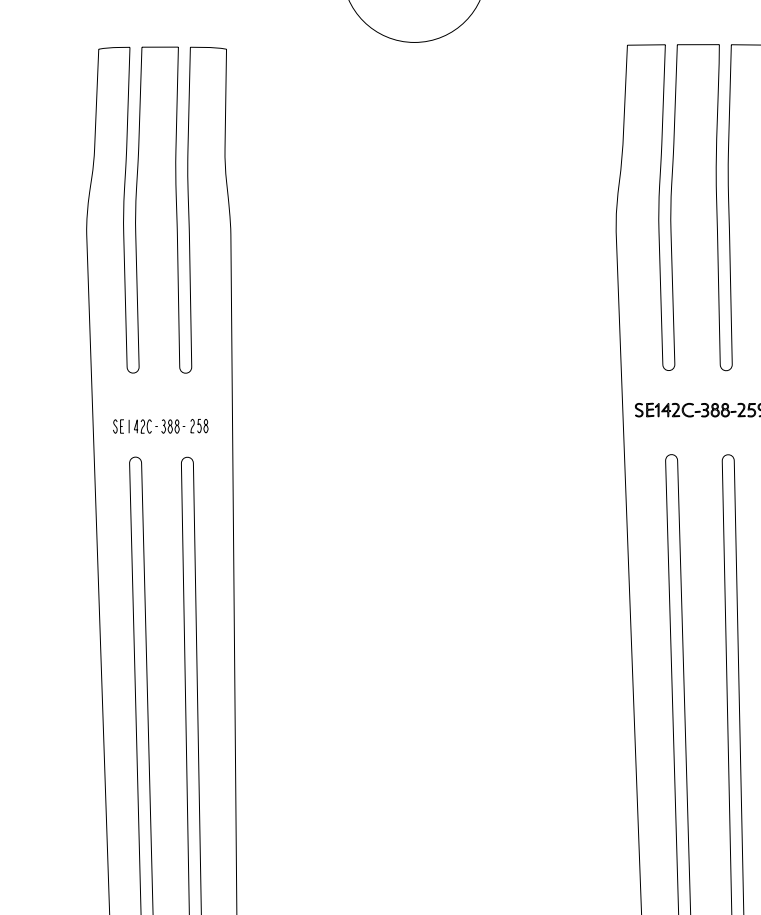

INSTANCE SE142C-388\_FLAT\_NEW\_258 INSTANCE SE142C-388\_FLAT\_NEW\_259

2 THESE PARTS TO BE NEMA GRADE G11CR MATERIAL

Oak Ridge National Laboratory managed for the DEPARTMENT OF ENERGY under U.S. GOVERNMENT CONTRACT DE-AC05-00OR22725 UT-BATTELLE, LLC. Oak Ridge, Tennessee

PROJECT NAME: NATIONAL COMPACT STELLARATOR EXPERIMENT

MODULAR COIL TYPE - C  
SIDE "A" LOWER BOTTOM CHILL PLATE  
FLAT PATTERN LAYOUT

VERSION NO.	PLANT	BLDG	FL	SHT	OF	TYPE	CLASS
3+	X-10	5700	3	5	5	S	U
RELEASE LEVEL		SE142C-388		REV		2	
WIP							

