

➤ **Type E Mil-Spec Plug**

■ **Weldable, Single-Ended**

**IN THIS SECTION ➤**  
**Type E T/C Screw-On**

- Multipin screw-on connectors
- Available in 2, 3, 5, and 10 pair
- Positive wires are made of Chromel™ and the negative wires are made of constantan
- Temperature range of -200° C to +900° C

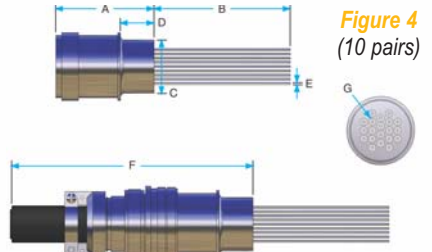
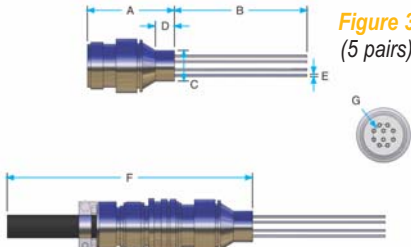
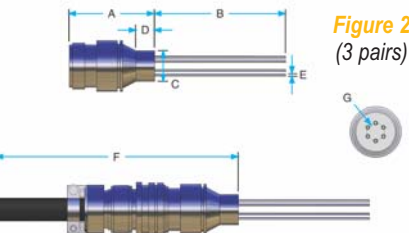
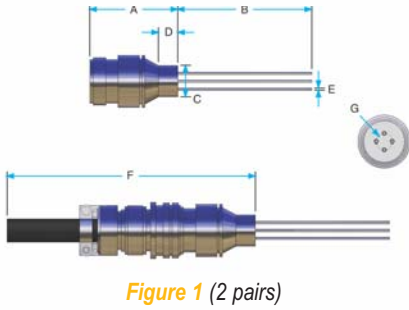

Figure	Air Side	Vac. Side	T/C Pairs	Dimensions (in.)							Part No.	Price
				A	B	C	D	E	F	G		
1	Mil-Spec Plug	Pins	2	2.35	3.2	0.747	0.46	0.056	4.03	0.38	TFT2EA00001	
2	Mil-Spec Plug	Pins	3	2.35	3.2	0.747	0.46	0.056	4.03	0.44	TFT3EA00001	
3	Mil-Spec Plug	Pins	5	2.35	3.2	0.747	0.46	0.056	4.03	0.51	TFT5EA00001	
4	Mil-Spec Plug	Pins	10	2.53	3.5	1.372	0.76	0.056	4.78	1.03	TFTVEA00001	

Refer to Connectors & Cabling, starting on page 3-114, for mil-spec connectors, crimp/solder connectors, t/c wire, wire beads, and ceramic wire discs.

■ **CF Flange, Single-Ended**

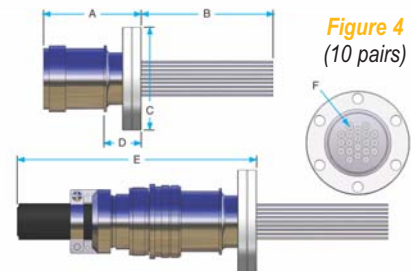
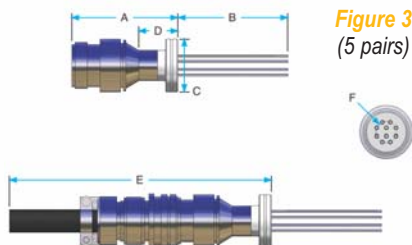
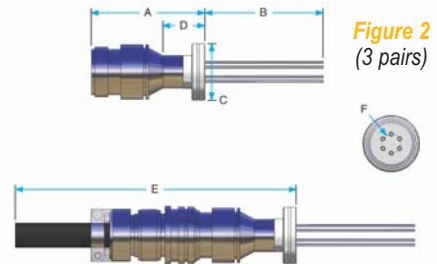
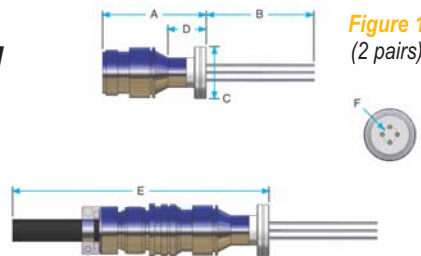

Figure	Air Side	Vac. Side	Flange Size	T/C Pairs	Dimensions (in.)							Part No.	Price
					A	B	C	D	E	F			
1	Mil-Spec Plug	Pins	1.33"CF	2	2.85	2.7	1.33	0.96	4.53	0.38	TFT2EA00002		
1	Mil-Spec Plug	Pins	2.75"CF	2	2.35	3.2	2.75	0.46	4.03	0.38	TFT2EA00003		
2	Mil-Spec Plug	Pins	1.33"CF	3	2.85	2.7	1.33	0.96	4.53	0.44	TFT3EA00002		
2	Mil-Spec Plug	Pins	2.75"CF	3	2.35	3.2	2.75	0.46	4.03	0.44	TFT3EA00003		
3	Mil-Spec Plug	Pins	1.33"CF	5	2.85	2.7	1.33	0.96	4.53	0.51	TFT5EA00002		
3	Mil-Spec Plug	Pins	2.75"CF	5	2.35	3.2	2.75	0.46	4.03	0.51	TFT5EA00003		
4	Mil-Spec Plug	Pins	2.75"CF	10	2.53	3.5	2.75	0.76	4.78	1.03	TFTVEA00003		

Refer to Connectors & Cabling, starting on page 3-114, for mil-spec connectors, crimp/solder connectors, t/c wire, wire beads, and ceramic wire discs.