

Annex to
Design Requirements and Guidelines Level 1 (DRG1)
Structural Material Database
Article 3. Non-Metallic Materials Database &
Specifications – Electrical Insulation Materials

Annex to
Design Requirements and Guidelines Level 1 (DRG1)
Structural Material Database
Article 3. Non-Metallic Materials Database & Specification
- Electrical Insulation Materials

Table of Contents

1	Introduction	1
2	Composition, Structure and Processing	1
2.1	Vacuum Pressure Impregnation (VPI)	5
2.2	Pre-Impregnation (prepreg)	5
3	Mechanical properties	7
3.1	Compressive Strength and Compressive Modulus	7
3.2	Interlaminare Shear Strength	8
3.3	Shear/Compression Strength	10
3.4	Fatigue Shear/Compression Strength	12
4	Electrical properties	29
4.1	Dielectric Strength	29
5	Thermal properties	31
5.1	Thermal Expansion	31
5.2	Thermal Conductivity	40
5.3	Density and Fiber volume	49
6	Recommended Design Values	49
6.1	Recommended Mechanical Properties	49
6.1.1	Compression strength (Through thickness direction)	49
6.1.2	Compression Modulus, Shear Modulus & Poisson's ratio	50
6.1.3	Interlaminare Shear Strength	52
6.1.4	Shear/Compression Strength	53
6.2	Electrical Properties	56
6.2.1	Dielectric Strength	56
6.2.2	Dielectric Strength for Inorganic Insulation Systems	56
6.3	Thermal Properties	56
6.3.1	Thermal Expansions	56
6.3.2	Thermal Conductivity	57
6.3.3	Density and Fibre Volume	58
7	References	58

1 Introduction

This annex contains the molecular composition and structure, Mechanical, Electrical and Thermal properties for the selected insulation materials to be used in the ITER coil system.

Most of the data has been provided by the ITER participating Home Teams (EU, JA, RF, US) through a series of Task Agreements as shown in Table 1-1. Insulation properties handbooks and journal publication have also been used to compile the database.

The selection of the resin systems was based on task agreements placed with each Home Team to survey, screen, sample fabricate and test, current resin systems and evaluate their suitability for the ITER coils. Upon completion of the task agreements the Home teams submitted to JCT the resin system or (s) which met the needs of the ITER Coils. It is these resin system that are shown in this annex.

Table 1-1 Task Agreement related to insulation R&D Program

EUHT ⁽¹⁾	JAHT ⁽²⁾	RFHT ⁽³⁾	USHT ⁽⁴⁾
N11TT07 94-02-15 FE	N11TT08 94-02-15 FJ	N11TT09 94-02-15 FR	N11TT10 94-02-15 FU
N11TT11 94-05-20 FE	N 11 TT 60 FJ		N11TT14 94-05-10 FU
N14TT23 06-06-10 FE	N 11 TT 73 FJ		N11TT39 FU
	N14TT23 96-06-10 FJ		N11TT52 94-12-15 FU 01
			N11TT74 FU

- 1) European Union Home Team
- 2) Japanese Home Team
- 3) Russian Federation Home Team
- 4) United States Home Team

2 Composition, Structure and Processing

Table 2-1 illustrates the composition of vacuum pressure impregnation (VPI) resin systems tested by the EU and US HTs.

Table 2-1 Vacuum Pressure Impregnation resin systems

Resin System designation	Resin Type	Hardener	Accelerator	Mass g	Degas Temp C	Gel Temp C	Cure C/hrs
EUHT (1)							
DGEBA/ Acid anhydride/ Tertiary Amine	CY1300			100			
		HY917		85	60	80	120/15
			DY073	1.0			
DGEBA/ Liquid Aromatic Amine	GY282			100			
		HY5200		26	40	80	130/20
			0.0	0			
TGPAP/ Liquid Aromatic Amine	MY0510			100			
		HY5200		42	40	80	130/20
			0.0	0			
USHT(2)							
flex DGEBA/ anhydride (CTD 101K)	na			na			
		na		na	na	na	135/1.5
			na	na			
DGEBA/ anhydride (shell 826)	na			na			
		na		na	na	na	150/4
			na	na			

na - not available, 1- ref. [1], 2- ref. [2]

Table 2-1 illustrates the composition of the pre-impregnation resin systems tested by the EU and US THs.

Table 2-2 Pre-impregnation resin systems

Resin System Designation	Cure Temperature (C)	Cure Duration (hours)	Cure Pressure (Bars)
Epoxy Novolak ¹	130	3	2
TGDM /amine ²	177	2	na

1 - ref [1], 2 - ref [2]

Figure 2-1 illustrates a series of viscosity tests performed by the EUHT on the resin systems which the home team has selected as potentially feasible for the ITER Coils. Per its investigation, 1000 mPa.s (dashed line on Figure 2-1) was selected as the viscosity limit for vacuum pressure impregnation of the ITER Coils. No other home team presented viscosity data. However as part of the R&D program (TAs) the Home teams were to select resin systems which were applicable to the ITER Coils.

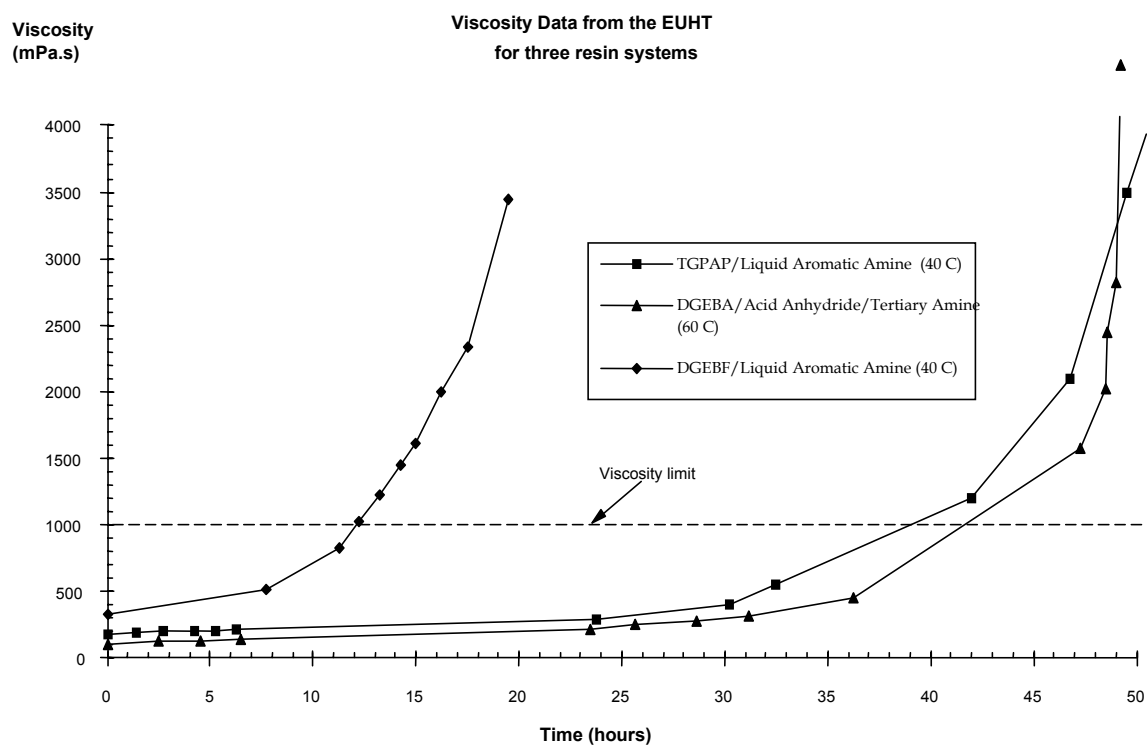

Figure 2-1 Illustrates viscosity data from the EUHT resin systems. The dashed horizontal line indicates the viscosity acceptance level. Ref. [1]

The molecular chain structure for the principle resin and hardeners systems evaluated by the EU and US HTs are illustrated in the following Figures 2-2, to 8.

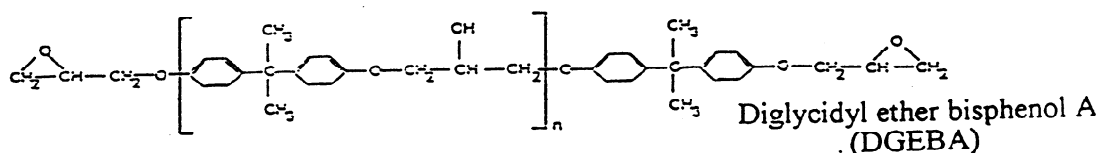

Figure 2-2 Compositional structure of Diglycidyl ether bisphenol A (DGEBA) epoxy resin. (ref. [3])

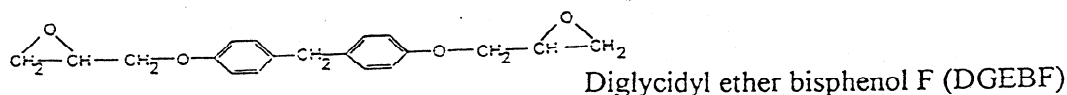
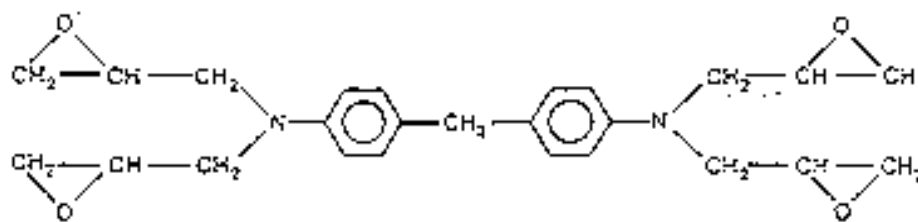
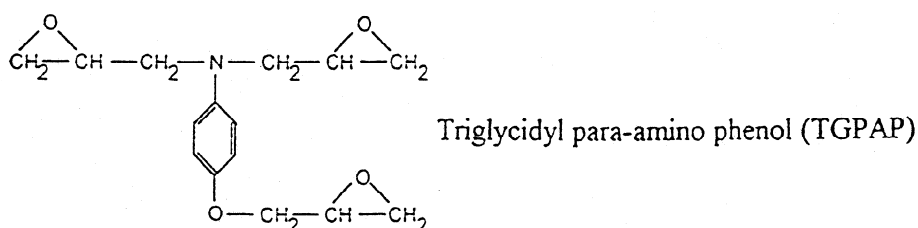

Figure 2-3 Compositional structure of Diglycidyl ether bisphenol F (DGEBF) epoxy resin. (ref. [3])



Tetraglycidyl Diaminodiphenyl Methane (TGDM)

Figure 2-4 Compositional structure of Tetraglycidyl Diaminodiphenyl Methane (TGDM) epoxy resin. (Ref. [3])



Triglycidyl para-amino phenol (TGPAP)

Figure 2.-5 Compositional structure of Triglycidyl para-amino phenol (TGPAP) epoxy resin. (ref. [3])

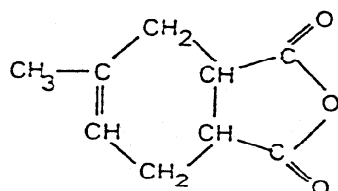

METHYL TETRAHYDROPHTHALIC ANHYDRIDE

Figure 2-6 Compositional structure of Methyl Tetrahydrophthalic Anhydride hardener. (ref. [3])

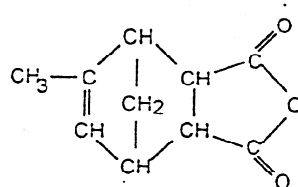

1,4-ENDO METHYLENE,5-METHYL CYCLOHEXANOIC ANHYDRIDE
(METHYL 'NADIC' ANHYDRIDE (MNA))

Figure 2-7 Compositional structure of 1,4 Endo Methylene, 5, Methyl Cyclohexanoic Anhydride (Methyl 'Nadic' Anhydride (MNA)) hardener. (ref. [3])

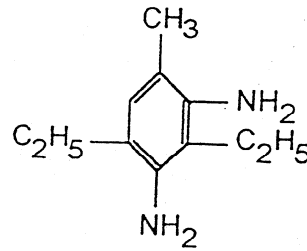

DIAMINO DIETHYL TOLUENE

Figure 2-8 Compositional structure of Diamino Diethyl Toluene hardener. (ref. [3])

Vacuum pressure impregnation (VPI) and pre-impregnation (prepreg) processes were used in the manufacture of the insulation composite samples.

Figure 2-9 illustrates the vacuum pressure impregnation apparatus used by the EUHT in its manufacturing of the VPI samples. The process typically consists of the following steps:

2.1 Vacuum Pressure Impregnation (VPI)

- 1) Sample mold preparation. This process differs depending on the type of samples to be manufactured and Home Team. The EUHT chose to manufacture large discs and then to cut them into the appropriate sample size (see Annex IV). The USHT chose to manufacture individual samples of the desired size and eliminate the machining process. In either case the results were consistent and within the expected data scatter.
- 2) The resin system is placed in the potting bucket and the required tubing to guide the resin is connected to the prepared mold. The potting bucket is then sealed.
- 3) The potting bucket, and the mold evacuation tubes are evacuated simultaneously, in order to minimize any pressure differential between the sample mold and potting bucket.
- 4) The resin is heated and degassed at a controlled pressure and temperature, based on the manufacture specifications.
- 5) A small positive pressure differential is then created between the potting bucket and the mold, to develop resin flow into the mold. When resin is visible in the mold evacuation port (tube) the valve is closed and higher pressure, typically in the order of two atmospheres, is applied in the potting bucket. With this process little or no distortion is developed in the mold, since there is no pressure difference between the potting bucket and inside the mold. This pressure is held throughout the curing temperature.
- 6) The mold is then heated (electrical heaters) to the curing temperature until the cycle is complete.

2.2 Pre-Impregnation (prepreg)

Figure 2-10 illustrates a typical manufacturing process of the prepreg cloth (fabric). The resin system is partially cured in the reinforcement cloth (fibre glass). The samples are manufactured from pieces of these larger sheets.

The manufacturing of prepreg sample consists of the following steps:

- 1) Cut the prepreg cloth to the desired diameter or shape and apply the appropriate prepreg lay-up into the specimen mold, and degas the mold. The degassing steps are dependent on the recommendation of the resin manufacture, and it is not always necessary.
- 2) The mold is pre-heated, sealed, and placed in a vacuum bag. The temperature and pressure are then raised and held at a specified rate based on resin manufacture specifications. Alternatively, prepreg systems can be manufacture without the use of an autoclave, but simply by using a vacuum bag (vac-bag) and an oven for curing. Weights are sometimes used to increase the applied pressure on the sample.

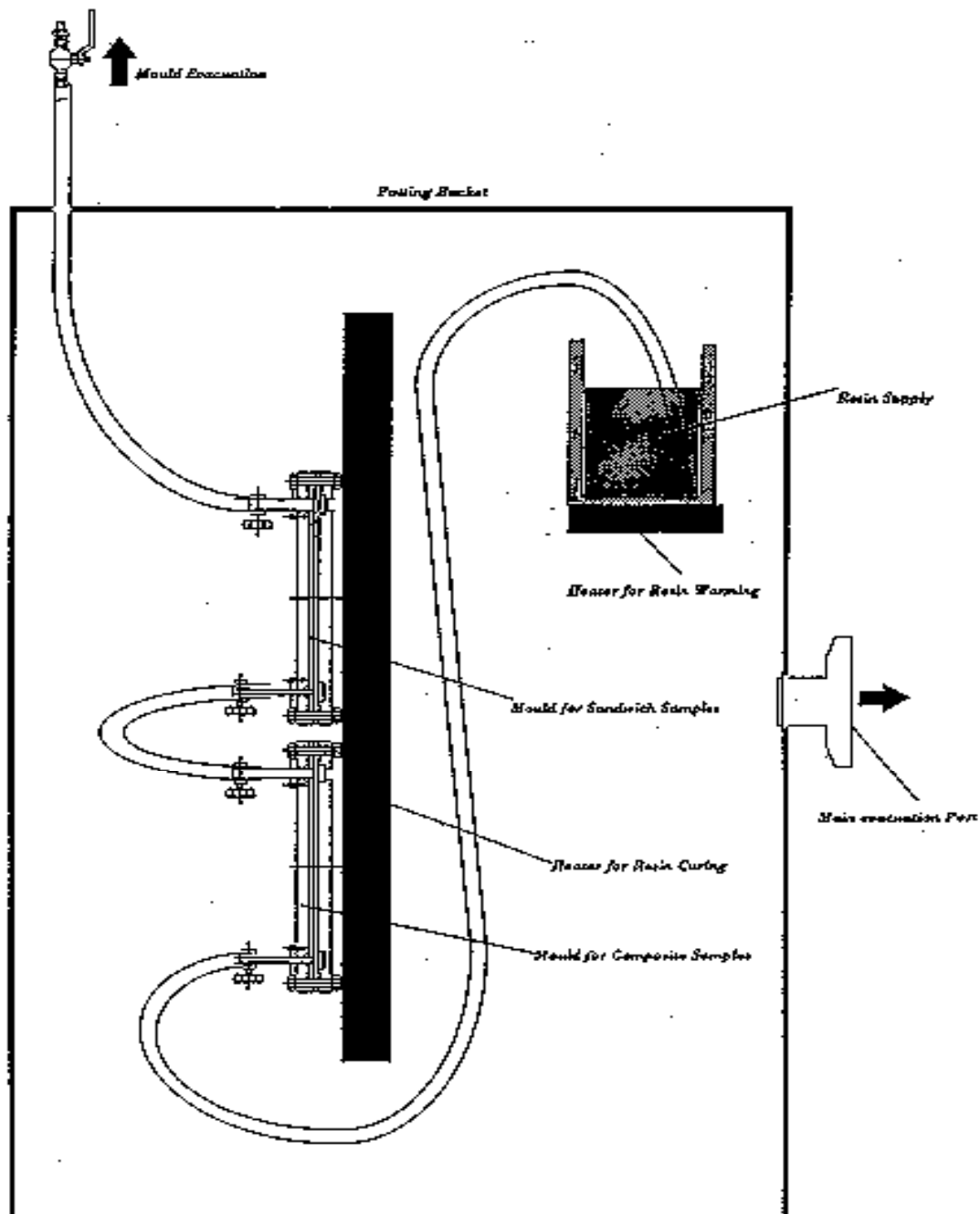

Figure 2-9 Illustrates a typical vacuum pressure impregnation apparatus. This particular system was used to fabricate the EUHT test samples. Ref. [1].

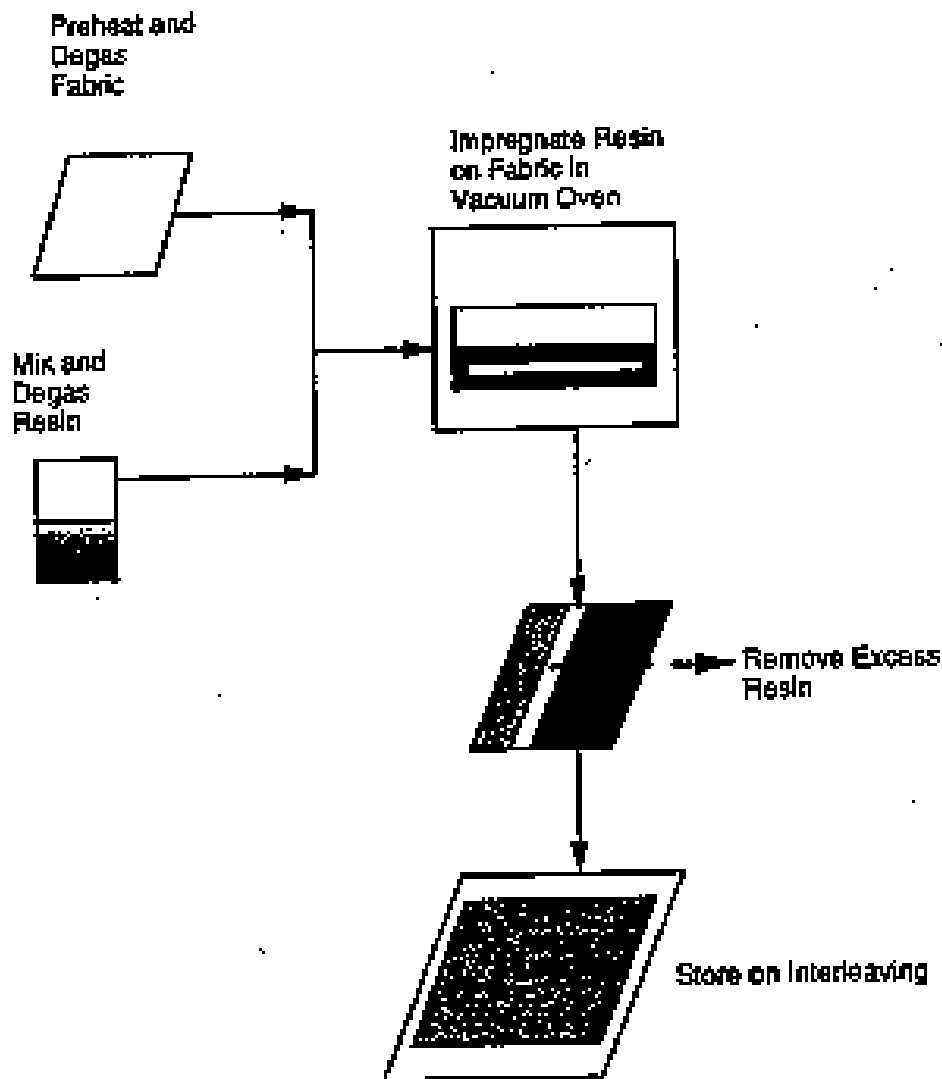

Figure 2-10 Illustrates a typical manufacturing process of the prepreg cloth (fabric). (ref. [2])

3 Mechanical properties

3.1 Compressive Strength and Compressive Modulus

Compressive Test Definition: Test procedure corresponds to ASTM 695 [Reference 2]. Specimen aspect ratios, h/d (where h is height and d is diameter) should ideally be between 2 and 4. Tests were invalid when the slope of the load-deflection curve begins to increase, which would indicate a dominating hydrostatic stress component within the specimen or meshing of the monolithic stress field of the opposing load platens. Loads were applied in the through thickness direction of the composite. Crosshead rates were limited to (< 1 mm/min) to preclude adiabatic heating effects.

Compressive Strength Definition: The highest load point in the load/deflection curve divided by the original cross-sectional area of the specimen.

Compressive Modulus Definition: The slope of the linear section of the load/deflection curve starting from the origin of the plot.

The compressive strength and compressive moduli of the tests performed by the EU and US HTs of their proposed insulation systems for ITER coils is shown in Table 3.1-1.

Table 3.1-1 Compression strength and Compressive Modulus of Insulation systems tested at 77 & 4.2K

Insulation systems	Compressive strength (MPa)	Compressive Modulus (GPa)	Temperature (K)	Resin Process
CTD-101K/S-2 glass ¹ (DGEBA)	1300	16.7	77	VPI
	1360	19.7	4.2	
shell 826/S-2 glass ¹ (DGEBA)	1310	17.9	77	VPI
	1290	19.4	4.2	
VPI 1 ² (DGEBA/Aromatic Amine)	1295	16.2	77	VPI
	1291	19.1	4.2	
VPI 5 ² (DGEBF/Liquid Aromatic amine)	1319	18.7	77	VPI
	1305	20.2	4.2	
VPI 6 ² (TGPAP/Aromatic amine)	1310	17.5	77	VPI
	1396	20.9	4.2	
VPI 12 ² (TGPAP/Aromatic amine & Ceramic coating)	1065	17.5	77	VPI
	1190	20.9	4.2	
CTD-112/S-2 glass ¹ (TGDM)	1220	18.6	77	Prepreg
	1260	23.7	4.2	
CTD 112/S-2 Glass with Kapton HA ¹ (TGDM)	1190	17.5	77	Prepreg
	1220	20.6	4.2	
P4 ² (Epoxy Novolak Prepreg)	1059.8	15.3	77	Prepreg
	1109	17.3	4.2	
P6 ² (Epoxy Novolak with Kapton)	931.2	13	77	Prepreg
	974	13.7	4.2	

1- ref. [2], 2- ref. [1]

3.2 Interlaminar Shear Strength

Table 3.2-1 illustrates the interlaminar shear strength of short beam shear tests performed at 77 and 4.2K on VPI and Prepreg insulation systems by the EU and US HTs.

Interlaminar shear test Definition: Short-beam shear tests were used to measure the interlaminar shear strength of insulating composite systems. The test used a three-point loading fixture, shown in Figure 3.2-1. Specimens were placed on the lower two loading pins (~ 6 mm diameter, hardened-steel pins with Rc~62), and the force was applied to the top of the specimen from a servo hydraulic actuator through a ~12 mm diameter hardened steel pin. A constant actuator deflection rate no greater than 0.2 mm/sec was used.

The Maximum shear stress (τ_{max}) was calculated as follows (ref. [2]):

$$\tau_{max} = 0.75 P/wt, P = \text{Max. applied load}, w = \text{Specimen width}, t = \text{Specimen thickness}$$

Note: The shear stresses are a maximum in the center of the specimen.

Interlaminare shear Strength Definition: The maximum applied load divided by the product of the specimen width times thickness, all multiplied by a constant of 0.75. The maximum applied load is defined as the highest load point along the load/deflection curve.

Flexure Modulus Definition: The slope of the linear portion of the short beam three point bend shear test load/deflection curve.

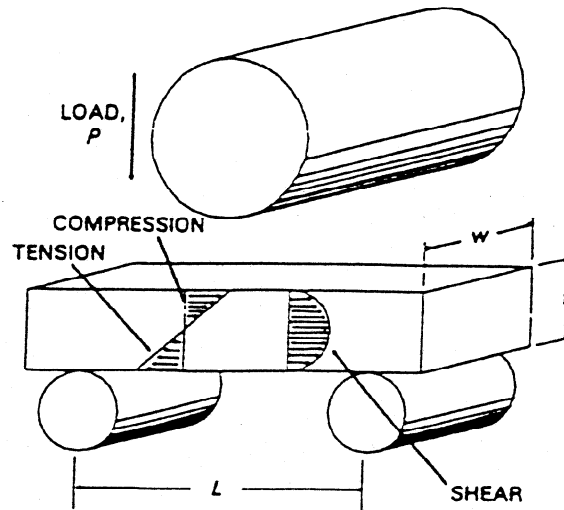

Figure 3.2-1 Three point bending Short beam shear test fixtures. (ref. [2])

Table 3.2-1 Short-Beam Shear test Results at 77 & 4.2 K

Insulation systems	Shear strength (MPa)	Flexural Modulus (GPa)	Temperature (K)	Resin Progress
CTD-101K/S-2 glass ¹ (DGEBA)	108	27.9	77	VPI(1)
	120	34.1	4.2	
shell 826/S-2 glass ¹ (DGEBA)	125	21.8	77	VPI(1)
	114	31.6	4.2	
VPI 1 ² DGEBA/Aromatic Amine	na	na	77	VPI(1)
			4.2	
VPI 5 ² (DGEBA/Liquid Aromatic amine)	na	na	77	VPI(1)
			4.2	
VPI 6 ² (TGPAP/Aromatic amine)	na	na	77	VPI(1)
			4.2	
VPI 12 ² (TGPAP/Aromatic amine & Ceramic coating)	na	na	77	VPI(1)
			4.2	
CTD-112/S-2 glass ¹ (TGDM)	67	29.5	77	Prepreg(2)
	69	27.9	4.2	
CTD 112/S-2 Glass with Kapton HA ¹ (TGDM)	92	21.8	77	Prepreg(2)
	65	20.2	4.2	
p4 ² (Epoxy Novolak Prepreg)	na	na	77	Prepreg(2)
			4.2	
p6 ² (Epoxy Novolak prepreg with Kapton)	na	na	77	Prepreg(2)
			4.2	

(1) - see section 2 for definition, (2) - see section 2 for definition, na = not available

1- ref. [2], 2- ref. [1]

Short beam measurements do not provide a pure interlaminar shear state which account for its higher strength value when compared to the intercept value with the y axis for Shear/compression strength curves (see Figure 6.1.3-1).

3.3 Shear/Compression Strength

The shear/compression test were performed in the test fixture illustrated in Figure 3.3-1. Tables 3.3-1 and 3.3-2 illustrate the shear/compression test results of VPI and prepreg insulation systems at 77K and 4K by the EU, JA and US HTs.

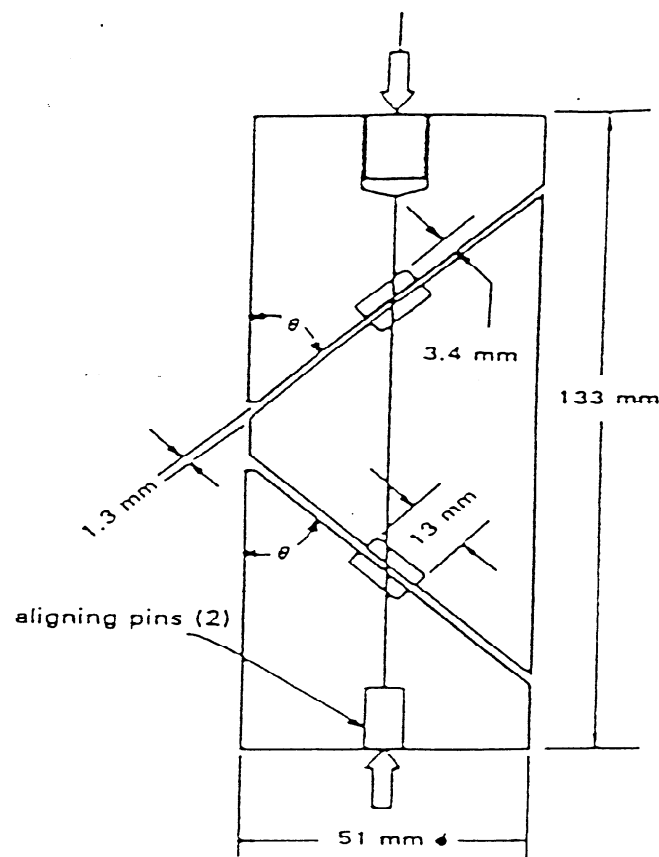

Figure 3.3-1 Shear/compression test fixture composed of three steel pieces. The central piece is not restraint. (ref. [2])

Shear/compression test: The fixture is composed of three separate pieces of high strength steel, which are aligned vertically by the two shear/compression specimens (circular or square) placed in recesses within the three pieces. The load is applied axially to the test fixture. Note that the center piece of the test fixture is free to move, therefore indeterminate shear strain does not accumulate in the specimen before failure. The shear and compressive loads are calculated as follows (ref. [2]):

$$\tau = (P \cos \theta)/A, \sigma = (P \sin \theta)/A$$

where:

τ = shear stress, σ = compressive stress, P = applied axial load

θ = fixture angle, measured from the vertical, A = cross-sectional area

Shear/compression Strength Definition: The maximum load reached in the load/deflection curve multiplied by the cosine of the angle of the test fixture, all divided by the original cross-sectional area of the specimen. For most insulation composite systems in this report the maximum load equal the fracture load.

Fracture Definition: When the specimen can no longer support shear and compressive loads.

Table 3.3-1 Static Shear/Compression Test Results at 77 K

Insulation systems		Sample angle (degrees)						
		15	20	30	45	60	70	75
Vacuum Pressure Impregnation resin systems								
CTD-101K/S-2 glass ¹ (DGEBA)	Comp Shear	29.6	na	na	175.8	na	na	933.2
		110.5			175.8			247.5
Shell 826/S-2 glass ¹ (DGEBA)	Comp Shear	25.4	na	na	176.7	na	na	956.2
		94.7			176.7			256.3
VPI 1 ² (DGEBA/Aromatic Amine)	Comp Shear	na	31.8	64.7	128.7	329.4	635.7	na
			87.3	112	128.7	190.2	231.4	
VPI 5 ² (DGEBA/Liquid Aromatic amine)	Comp Shear	na	35.3	75.4	181.7	367.5	709	na
			97.1	130.7	181.7	212.2	258.1	
VPI 6 ² (TGPAP/Aromatic amine)	Comp Shear	na	31.3	67.3	164.3	376	707.4	na
			86	116.5	164.3	217	257.5	
VPI 12 ² (TGPAP/Aromatic amine & Ceramic coating)	Comp Shear	na	22.3	56.9	134.7	392	652.4	na
			66	81.3	134.7	226.3	237.5	
Pre-impregnated resin systems								
Insulation Systems		Sample angle (degrees)						
		15	20	30	45	60	70	75
CTD-112/S-2 glass ¹ (TGDM)	Comp Shear	14.1	na	na	140.9	na	na	701.6
		52.6			140.9			188.1
CTD 112/S-2 Glass with Kapton HA ¹ (TGDM)	Comp Shear	12.4	na	na	108.8	na	na	458
		46.4			108.8			122.8
P4 ² (Epoxy Novolak Prepreg)	Comp Shear	na	27.5	55.6	144.5	357.4	654.4	na
			75.5	96	144.5	206.3	238.2	
P6 ² (Epoxy Novolak with Kapton)	Comp Shear	na	24.7	52.5	102.3	203.2	323.9	na
			67.7	90.9	102.3	117.3	117.9	
(DGEBA/Glass/etched kapton)	Comp Shear	na	30	60	118	240	460	na
			92	109	118	138	125	

na = not available, Stress Unit – Mpa, 1 - Ref. [2], 2 - Ref. [1]

Table 3.3-2 Static Shear/Compression Test Results at 4 K

Insulation systems		Sample angle (degrees)						
		15	20	30	45	60	70	75
Vacuum Pressure Impregnation resin systems (VPI)								
CTD-101K/S-2 glass ¹ (DGEBA)	Comp	27.9	na	na	178.3	na	na	1034.
	Shear	104.1			178.3			3 277.2
Shell 826/S-2 glass ¹ (DGEBA)	Comp	26.4	na	na	176.9	na	na	950.2
	Shear	99.8			176.9			254.7
Pre-impregnation resin systems (prepreg)								
CTD-112/S-2 glass ¹ (TGDM)	Comp	16	na	na	150.1	na	na	819.5
	Shear	59.5			150.1			219.7
CTD 112/S-2 Glass with Kapton HA ¹ (TGDM)	Comp	15.8	na	na	135.5	na	na	395.6
	Shear	58.9			135.5			106

na = not available, Stress Units – Mpa, 1 - Ref. [2]

3.4 Fatigue Shear/Compression Strength

The fatigue tests were performed with the same test fixtures used to evaluate the static shear/compression strength.

The USHT performed its tests at a frequency between 15 and 20 Hz depending on the placement of the test fixture. All Tests were performed with an load ratio (R) of 0.1. The applied load for fatigue testing was determined base on the static ultimate strength of the specimens tested at 77 K. The test were conducted at 90%, 80%, 70%, ... of the ultimate strength until 10^6 cycles were achieved. Note that the Shear/compression fatigue data illustrate a clear linear dependence of cycles to failure on applied stress.

The EUHT performed its fatigue tests with a modified test fixture, which tested six samples simultaneously Figure 3.4-1. The tests were performed at a frequency between 10 to 12 Hz depending on the displacement of the test fixture. When one sample failed the test fixture was removed and a steel dummy specimen was installed. The test was then continued, as each sample failed the cycles were recorded. The data of the six samples is plotted as the mean, and mean plus and minus one standard deviation for the number of cycles. The data was combined with the static mean and straight line interpolation was then used to interpolate or extrapolate the 10^5 cycles. This approach was only taken after the USHT had demonstrated that the data illustrated a clear linear dependence of cycles to failure.

The JAHT data was not presented in S-N plots but in Shear versus compression strength plots for 1×10^5 cycles. Please see section 6.0 for the JAHT fatigue data.

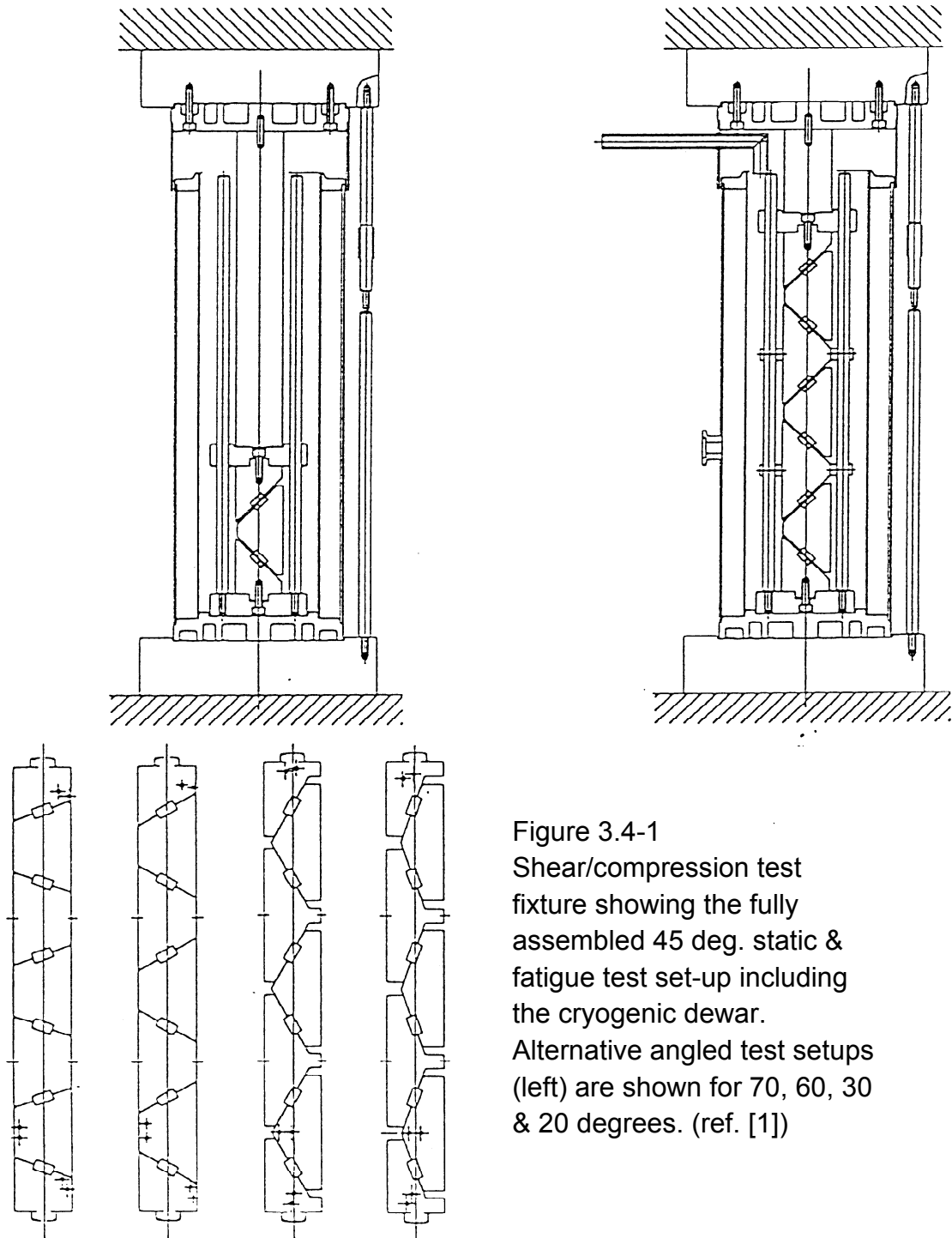

Figure 3.4-1
Shear/compression test
fixture showing the fully
assembled 45 deg. static &
fatigue test set-up including
the cryogenic dewar.
Alternative angled test setups
(left) are shown for 70, 60,
30 & 20 degrees. (ref. [1])

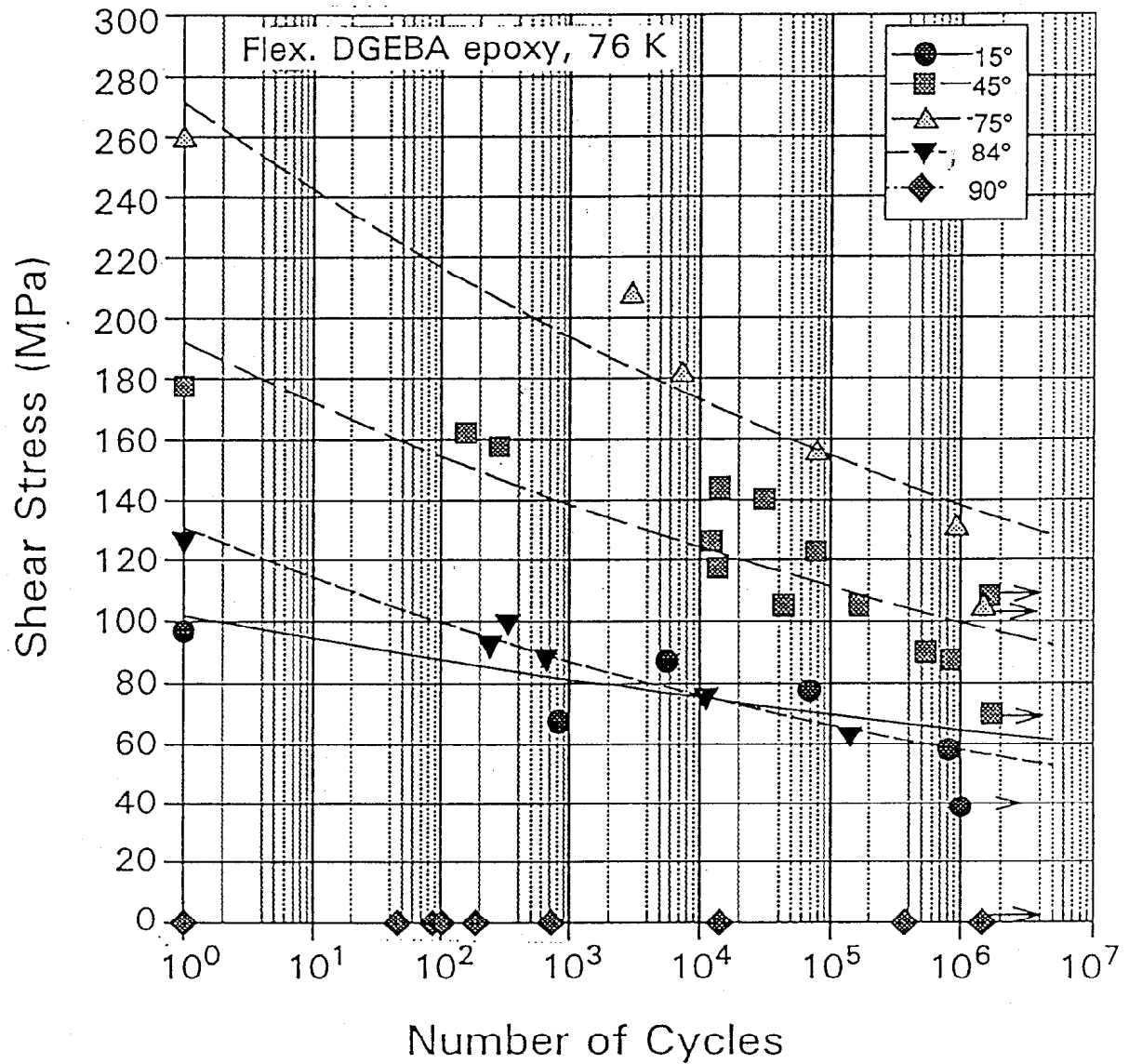

Figure 3.4-2 Fatigue tests performed by the USHT on the flexibilized DGEBA epoxy systems at 77K, load control, R=0.1 for combined shear/compression tests at four different test fixture angles (15°, 45°, 75°, & 84°), plotted versus the shear stress (Ref. [6]).

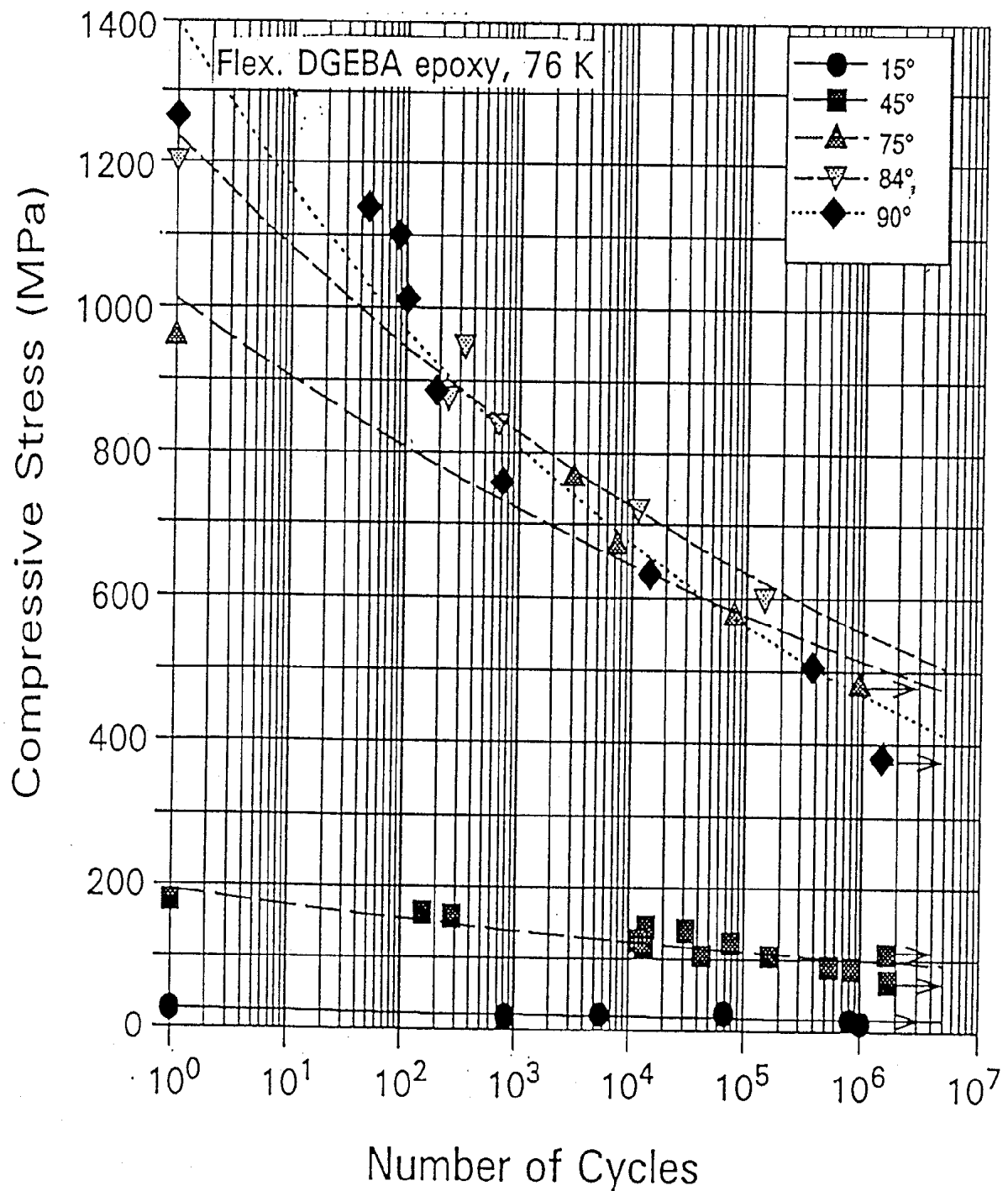

Figure 3.4-3 Fatigue tests performed by the USHT on the flexibilized DGEBA epoxy systems at 77K, load control, R=0.1 for combined shear/compression tests at four different test fixture angles (15°, 45°, 75°, & 84°), plotted versus the compression stress (Ref. [6]).

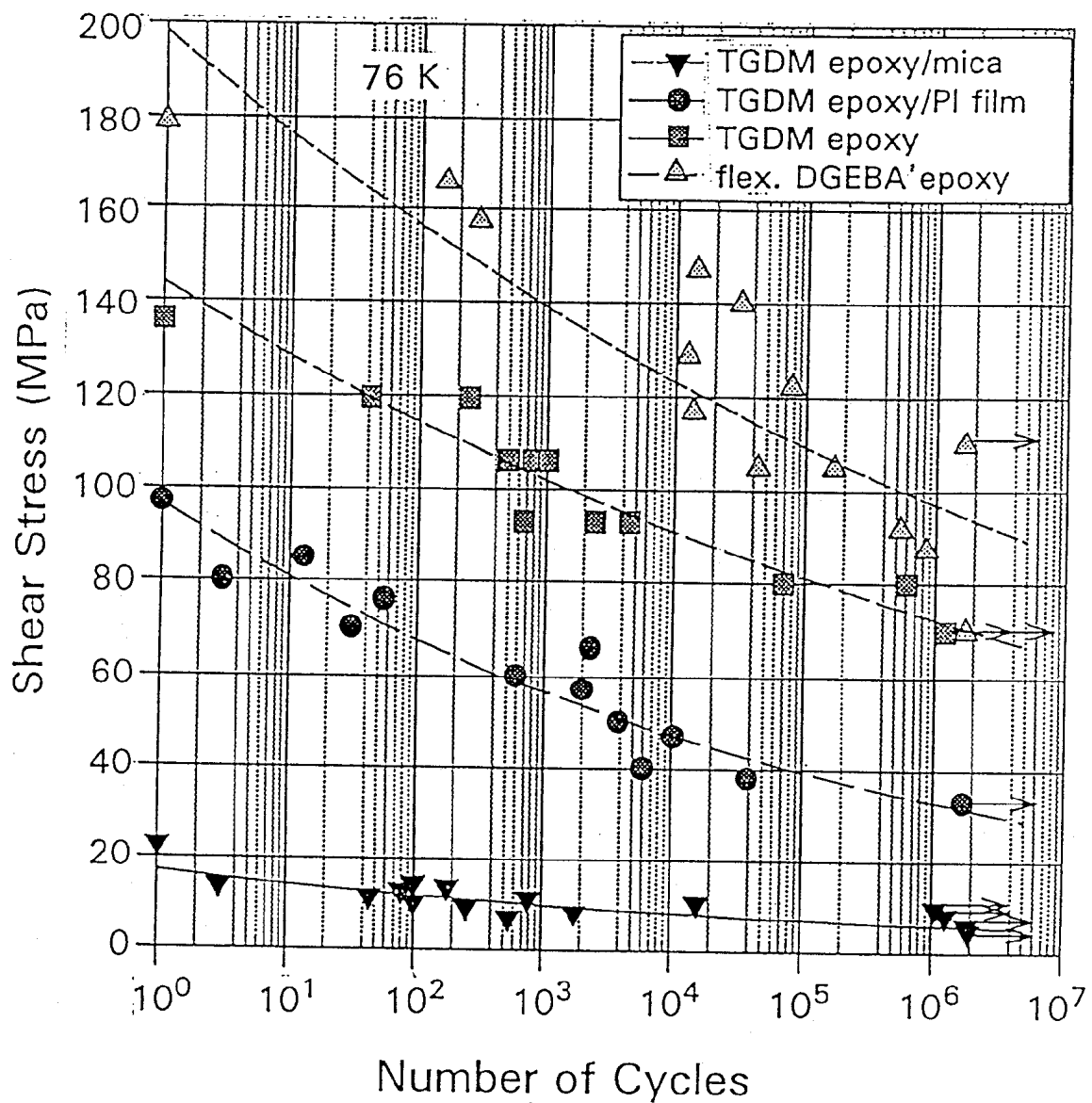

Figure 3.4-4 Fatigue S-N curves tested at 76K, load control, R=0.1, of four insulation systems tested at a test fixture angle of 45° (shear equals compressive stresses), plotted versus shear stress (Ref. [6]).

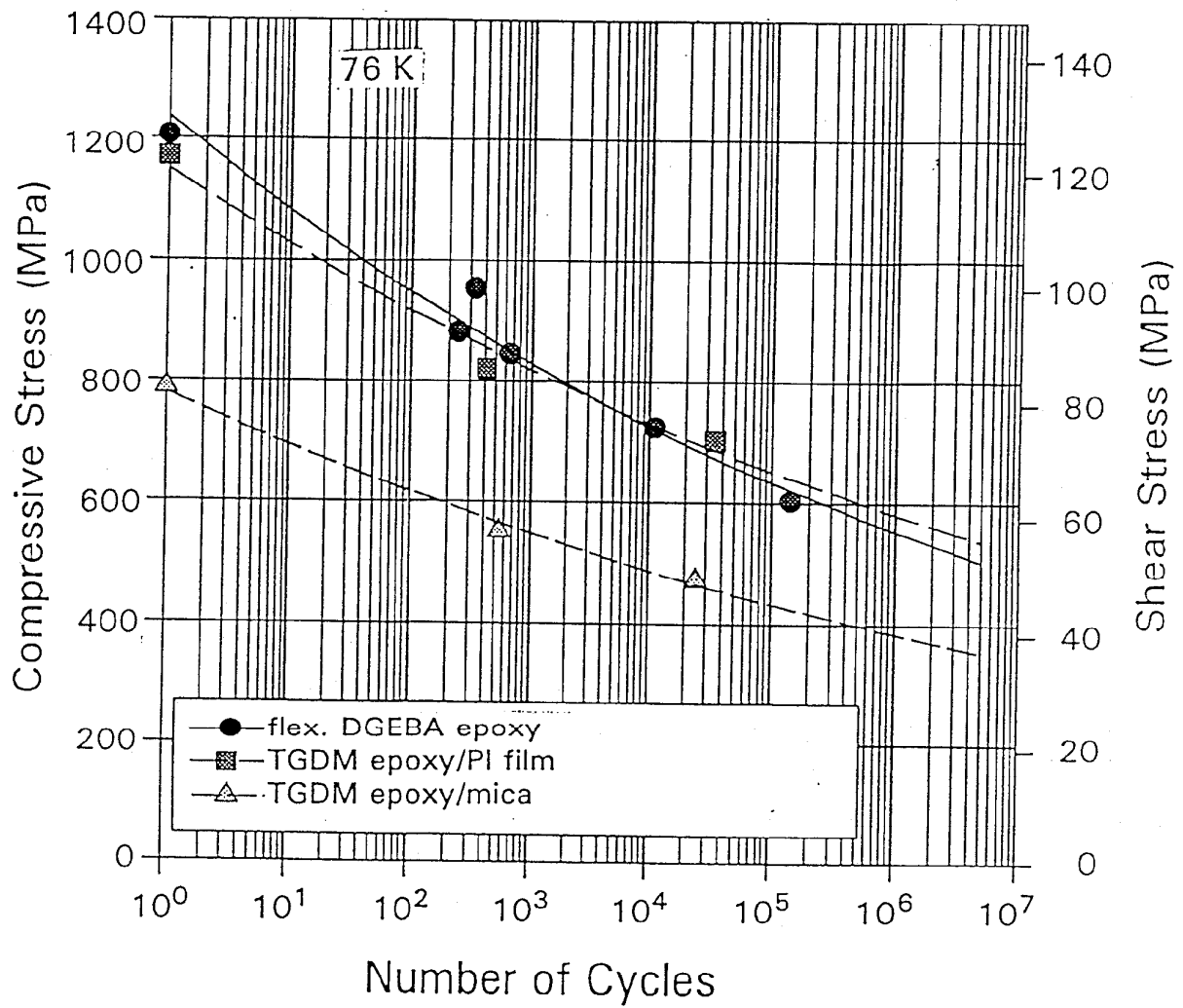

Figure 3.4-5 Fatigue S-N curves tested at 76K , load control, R=0.1, of three insulation systems tested at a test fixture angle of 84°, plotted versus compression stress (Ref. [6]).

Shear / Compression Static & Fatigue Data (77 K)

VPI 1 : DGEBA / Aromatic Amine / Tertiary Amine

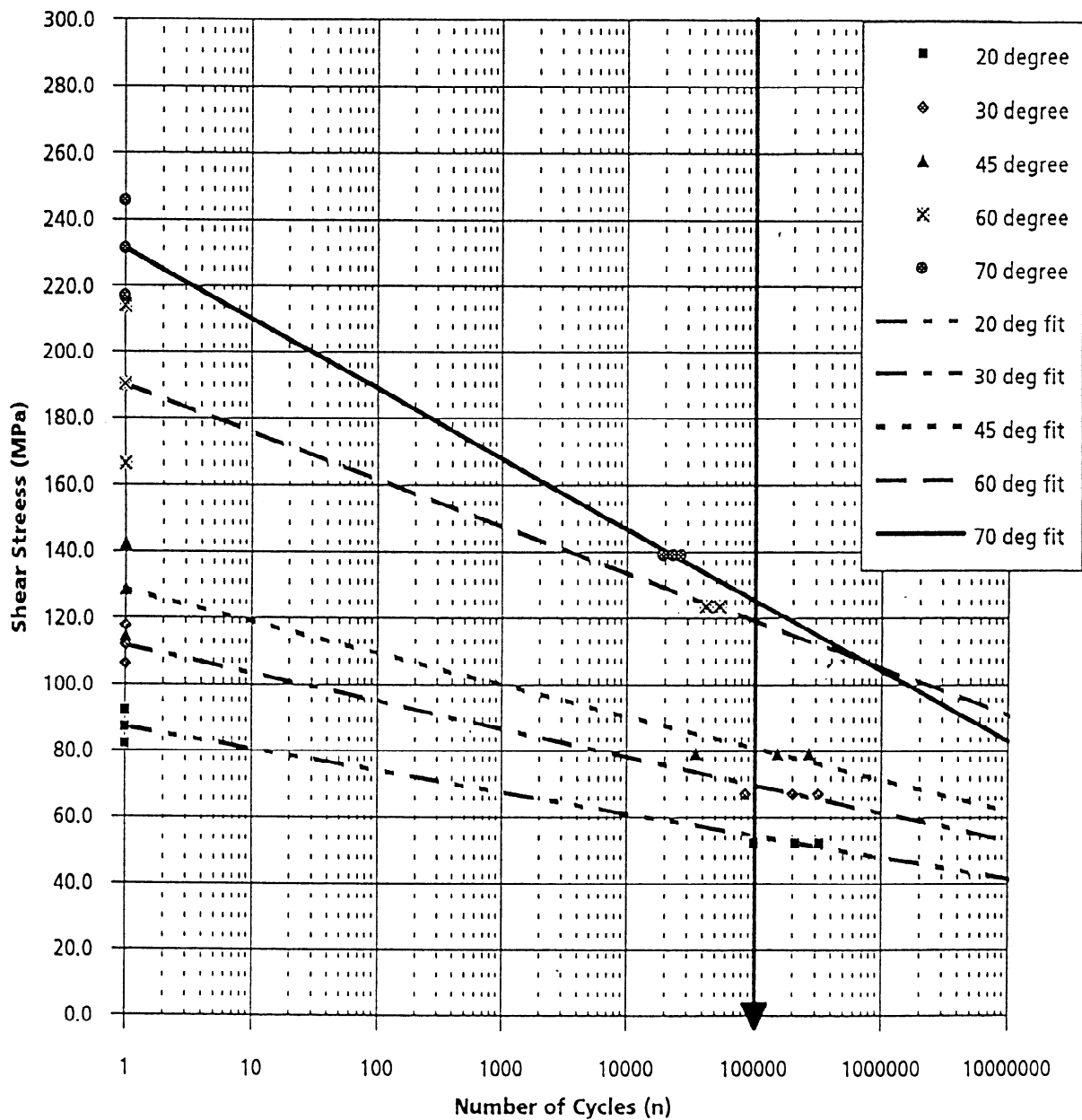

Figure 3.4-6 S-N curve at 77K load control, R=0.1 for VPI 1 insulation system tested at five test fixture angles plotted versus the shear stress (Ref. [1]).

Shear / Compression Static & Fatigue Data (77 K)
VPI 1 : DGEBA / Aromatic Amine / Tertiary Amine

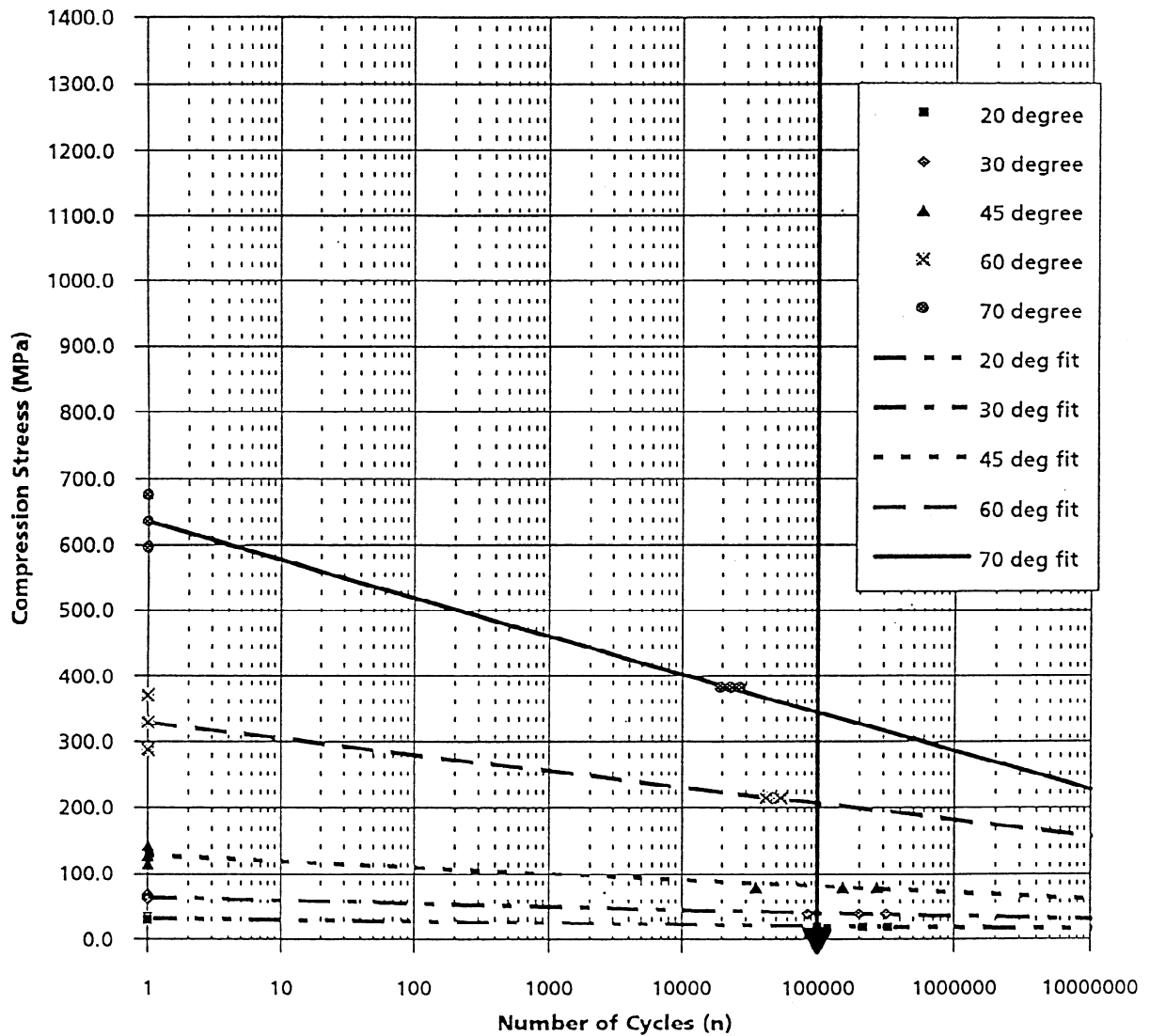

Figure 3.4-7 S-N curve at 77K, load control, R=0.1 for VPI 1 insulation system tested at five test fixture angles plotted versus the compression stress (Ref. [1]).

Shear / Compression Static & Fatigue Data (77 K)

VPI 5 : DGEBF / Aromatic Amine

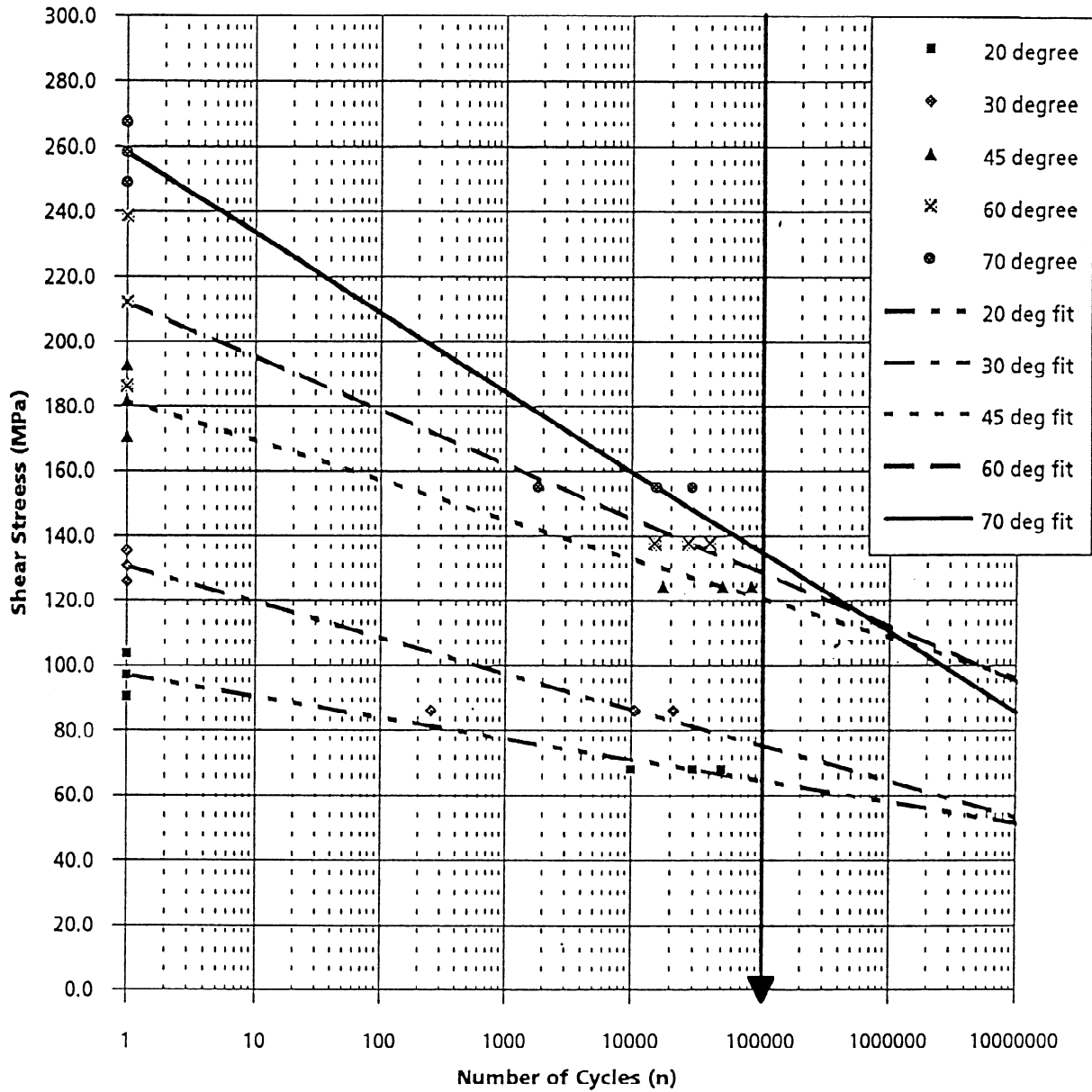

Figure 3.4-8 S-N curve at 77K, load control, R=0.1 for VPI 5 insulation system tested at five test fixture angles plotted versus the shear stress (Ref. [1]).

Shear / Compression Static & Fatigue Data (77 K)

VPI 5 : DGEBF / Aromatic Amine

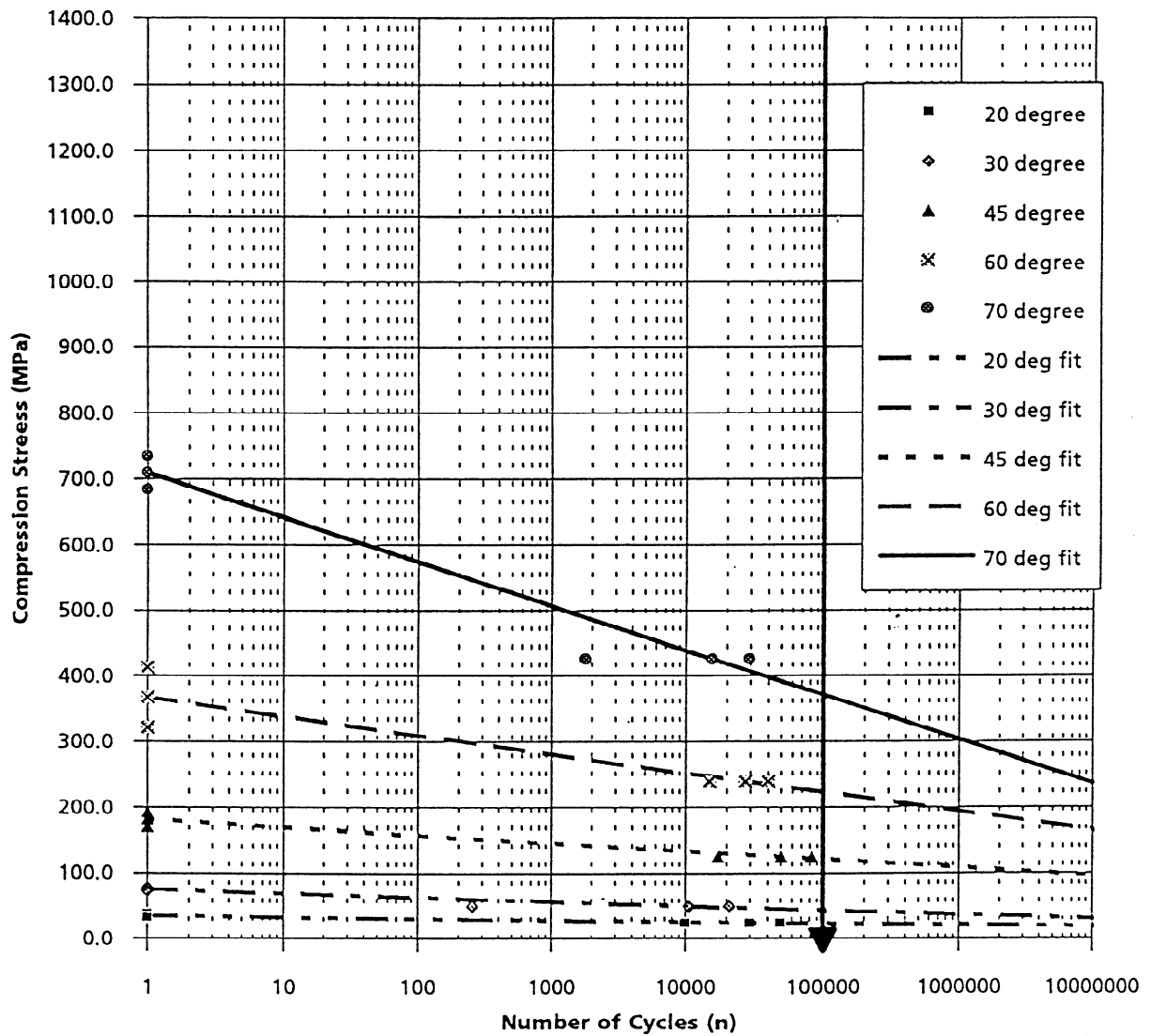

Figure 3.4-9 S-N curve at 77 K, load control, R=0.1 for VPI 5 insulation system tested at five test fixture angles plotted versus the compression stress (Ref. [1]).

Shear / Compression Static & Fatigue Data (77 K)

VPI 6 : TGPAP / Aromatic Amine

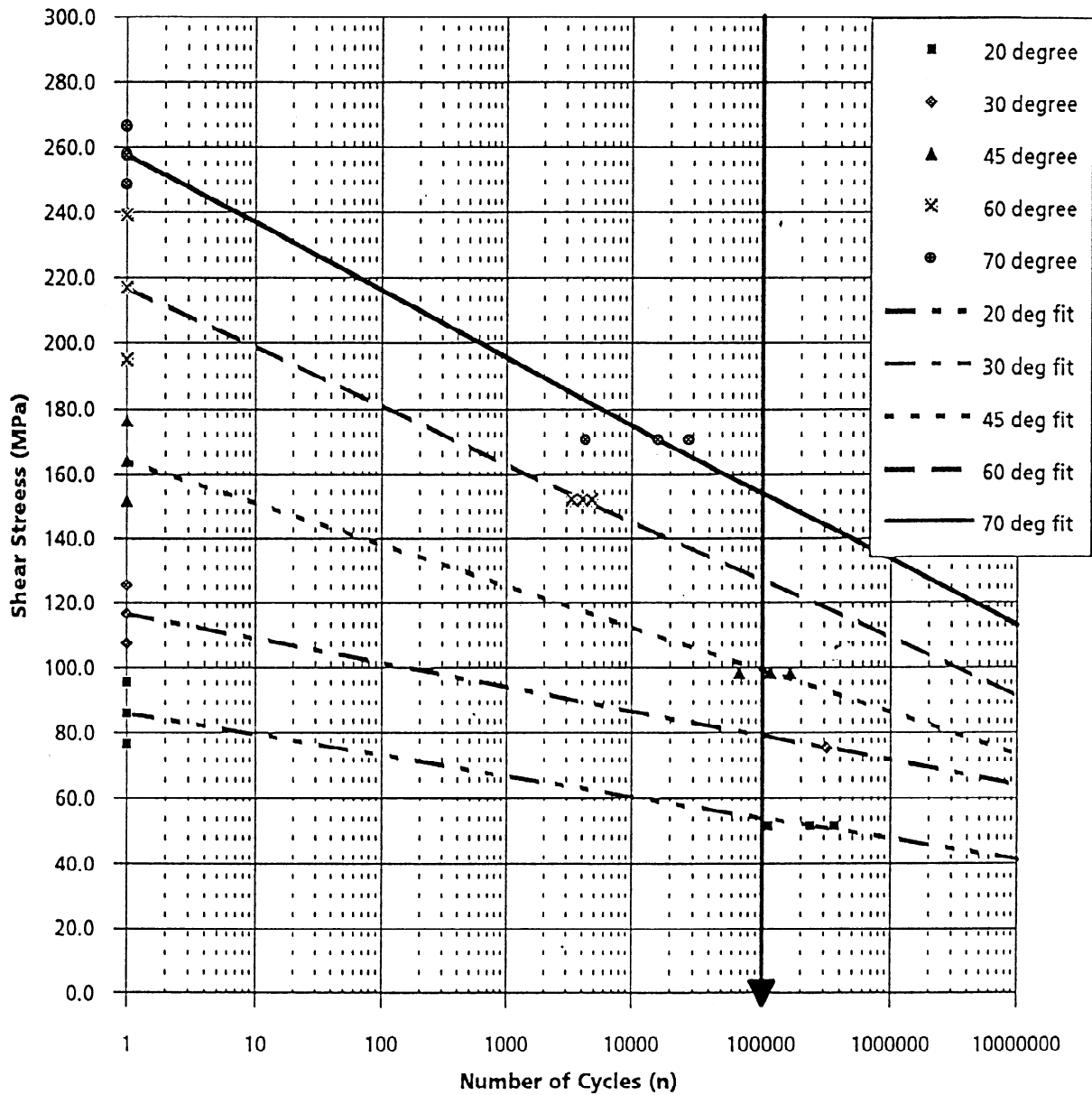

Figure 3.4-10 S-N curve at 77K, load control, R=0.1 for VPI 6 insulation system tested at five test fixture angles plotted versus the shear stress (Ref. [1]).

Shear / Compression Static & Fatigue Data (77 K)

VPI 6 : TGPAP / Aromatic Amine

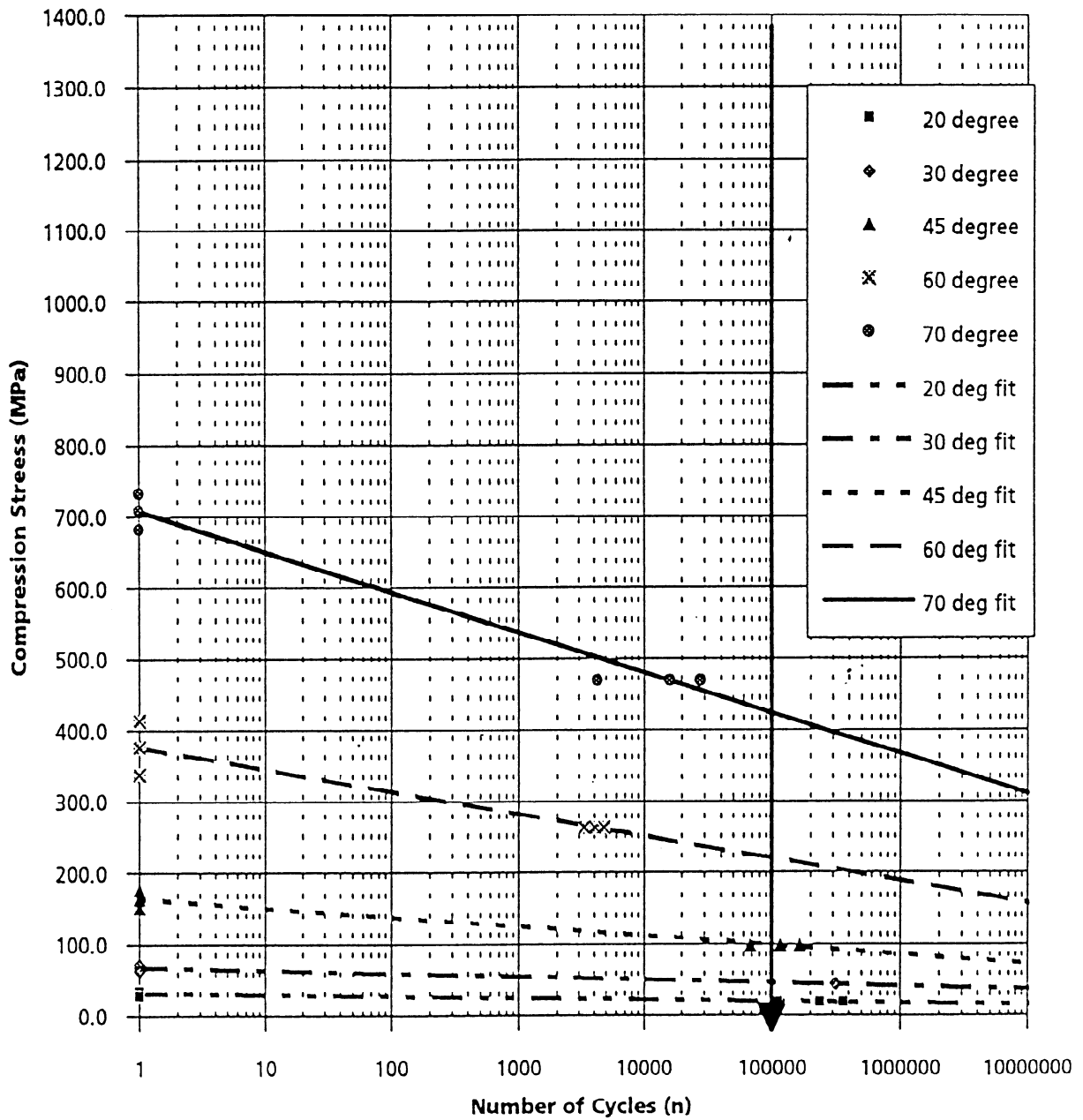

Figure 3.4-11 S-N curve at 77K, load control, R=0.1 for VPI 6 insulation system tested at five test fixture angles plotted versus the compression stress (Ref. [1]).

Shear / Compression Static & Fatigue Data (77 K)
VPI 12 : TGPAP / Aromatic Amine and Ceramic Coating

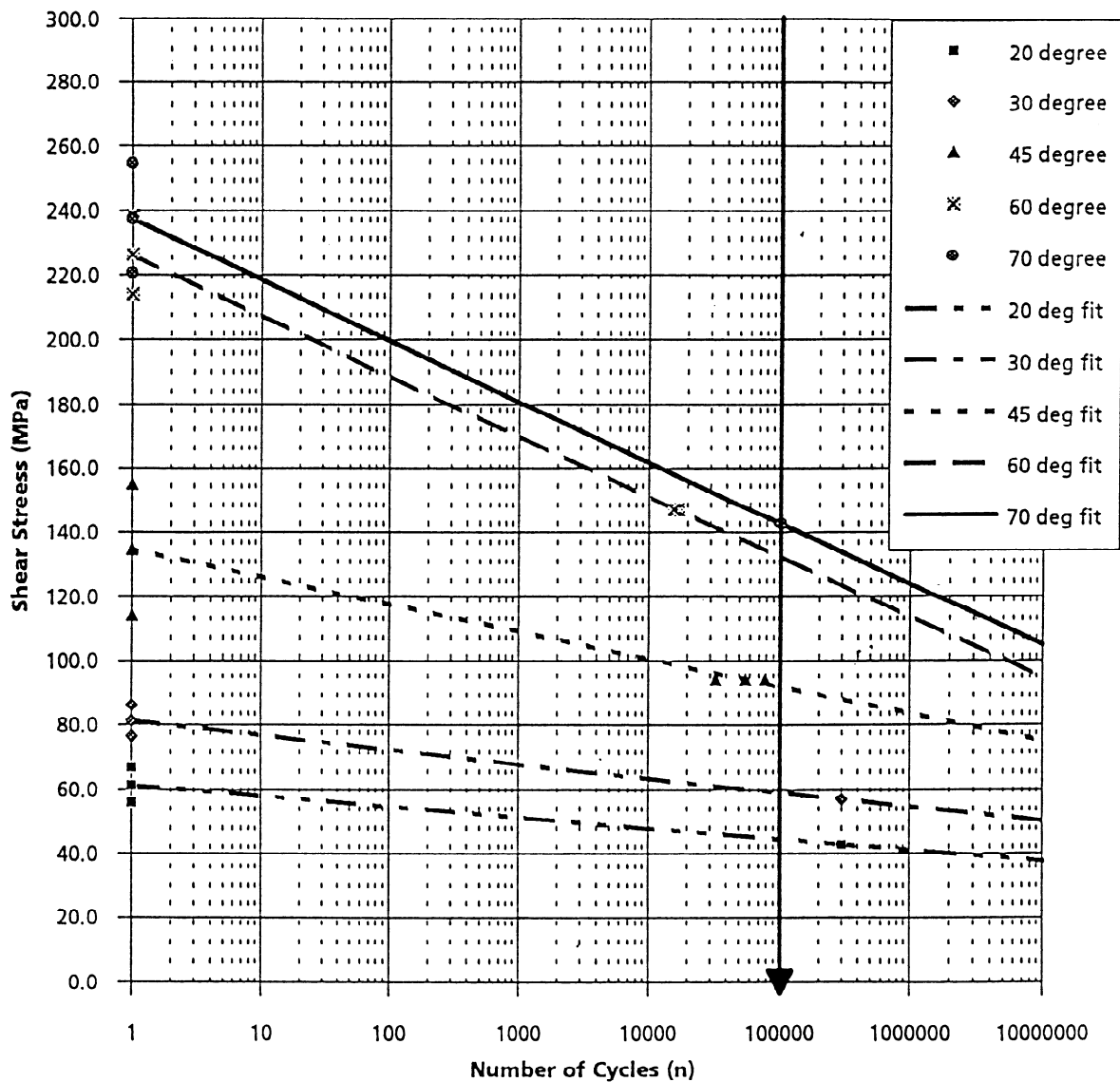

Figure 3.4-12 S-N curve at 77K, load control, R=0.1 for VPI 12 insulation system tested at five test fixture angles plotted versus the shear stress (Ref. [1]).

Shear / Compression Static & Fatigue Data (77 K)

VPI 12 : TGPAP / Aromatic Amine and Ceramic Coating

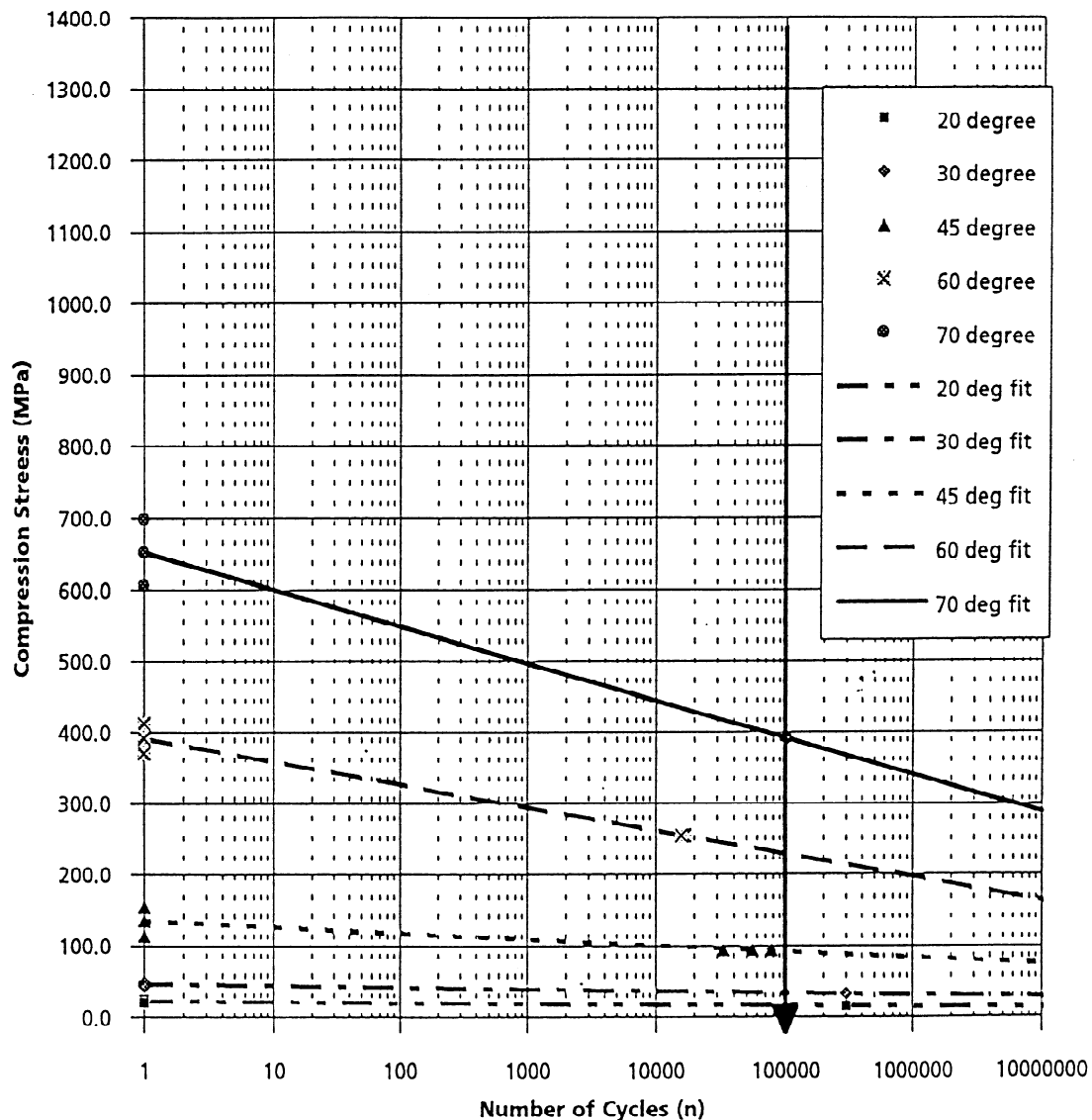

Figure 3.4-13 S-N curve at 77K, load control, R=0.1 for VPI 12 insulation system tested at five test fixture angles plotted versus the compression stress (Ref. [1]).

Shear / Compression Static & Fatigue Data (77 K)

P4 : Epoxy Novolak Prepreg

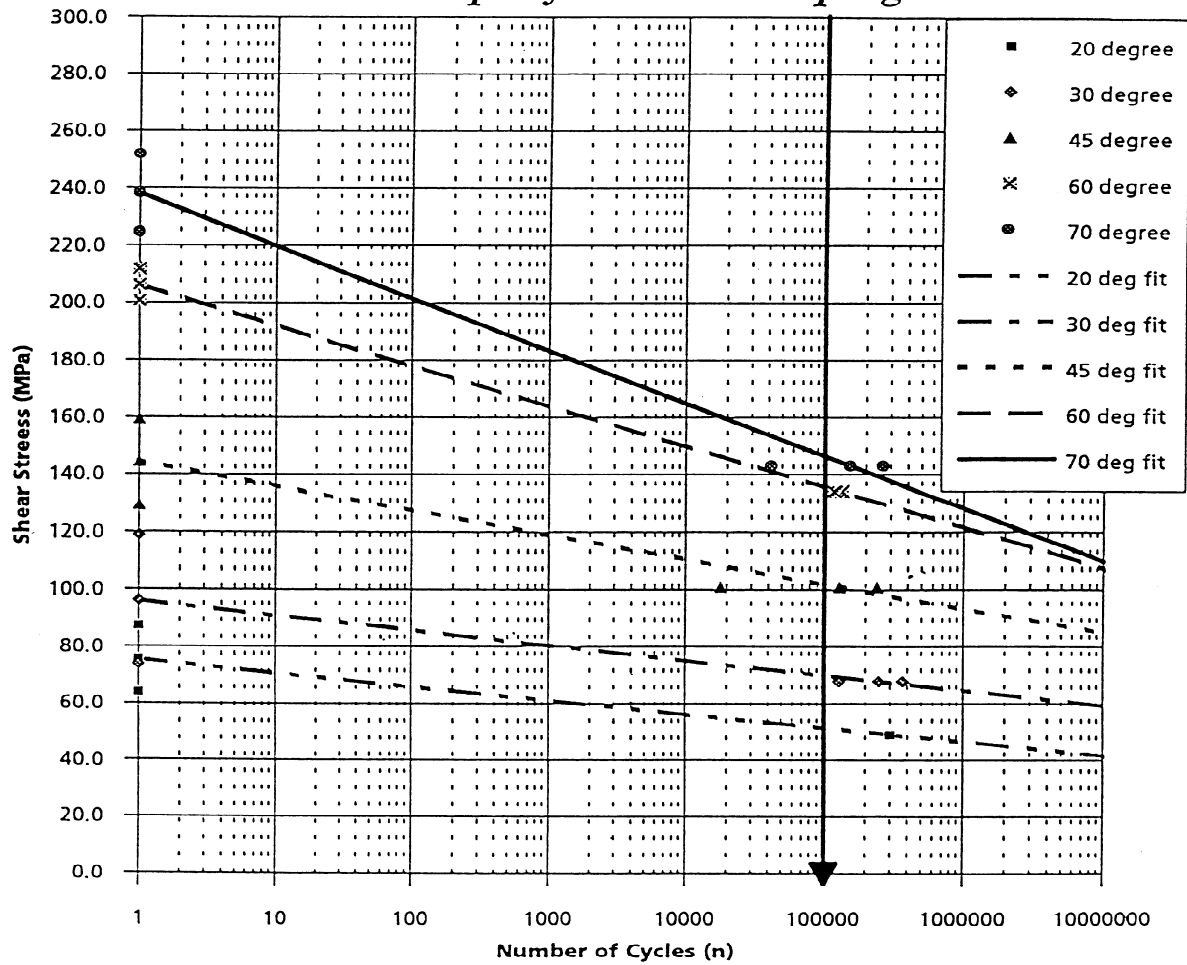

Figure 3.4-14 S-N curve at 77K, load control, R=0.1 for P4 insulation system tested at five test fixture angles plotted versus the shear stress (Ref. [1]).

Shear / Compression Static & Fatigue Data (77 K)

P4 : Epoxy Novolak Prepreg

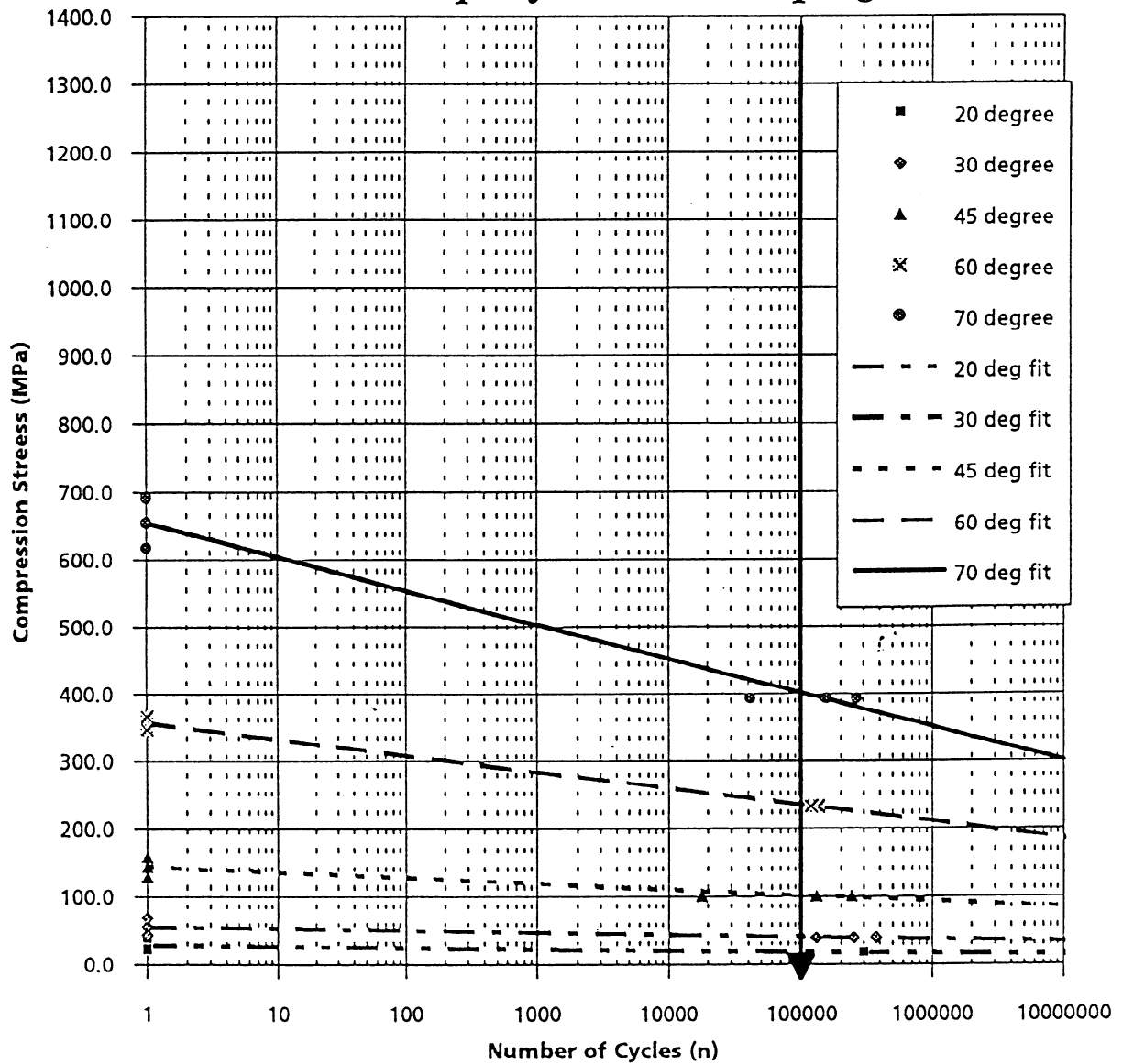

Figure 3.4-15 S-N curve at 77 K load control, R=0.1, for P4 insulation system tested at five test fixture angles plotted versus the compression stress (Ref. [1]).

Shear / Compression Static & Fatigue Data (77 K)

P6 : Epoxy Novolak / Kapton Prepreg

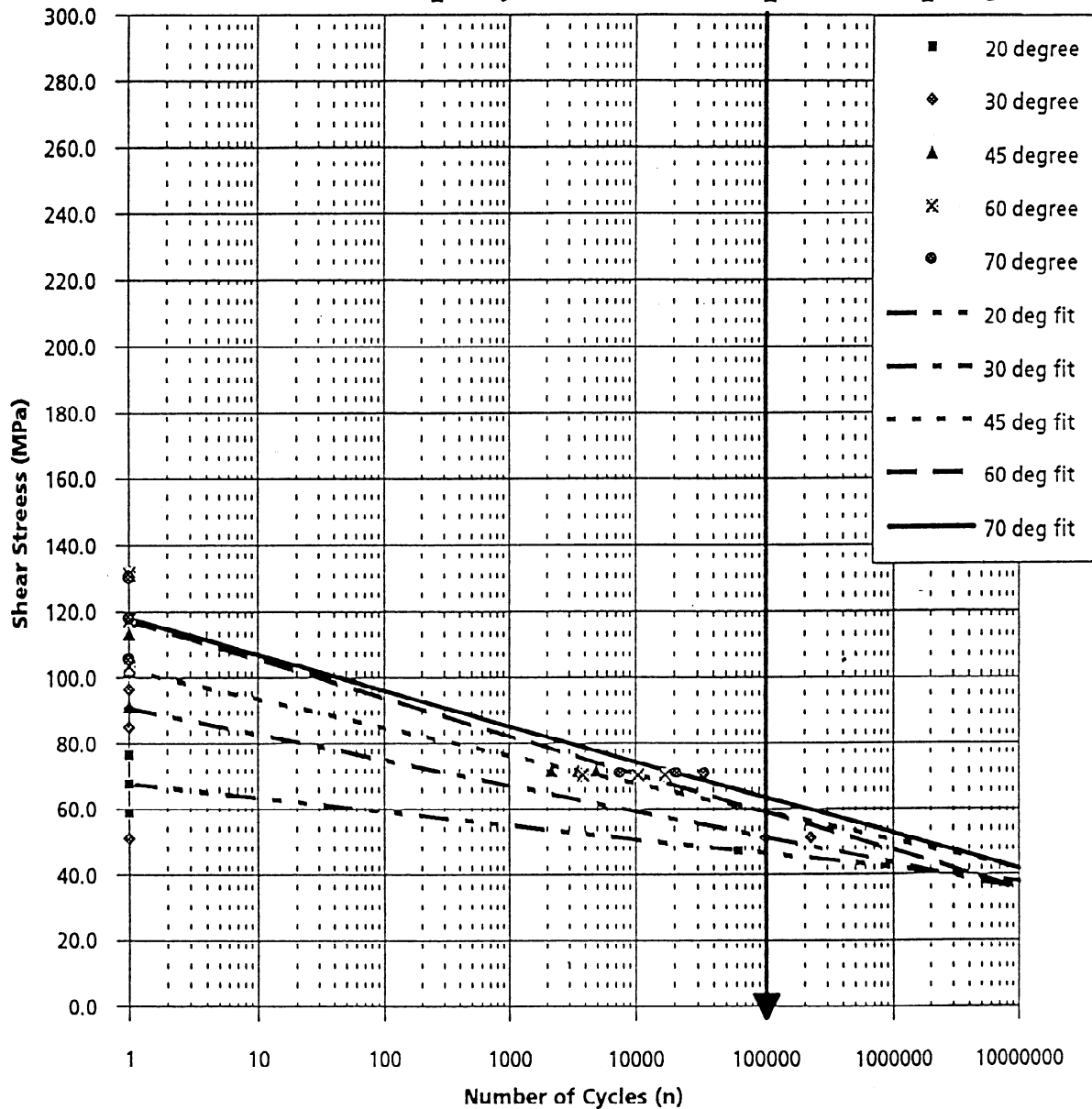

Figure 3.4-16 S-N curve at 77K, load control, R=0.1 for P6 insulation system tested at five test fixture angles plotted versus the shear stress (Ref. [1]).

Shear / Compression Static & Fatigue Data (77 K)

P6 : Epoxy Novolak / Kapton Prepreg

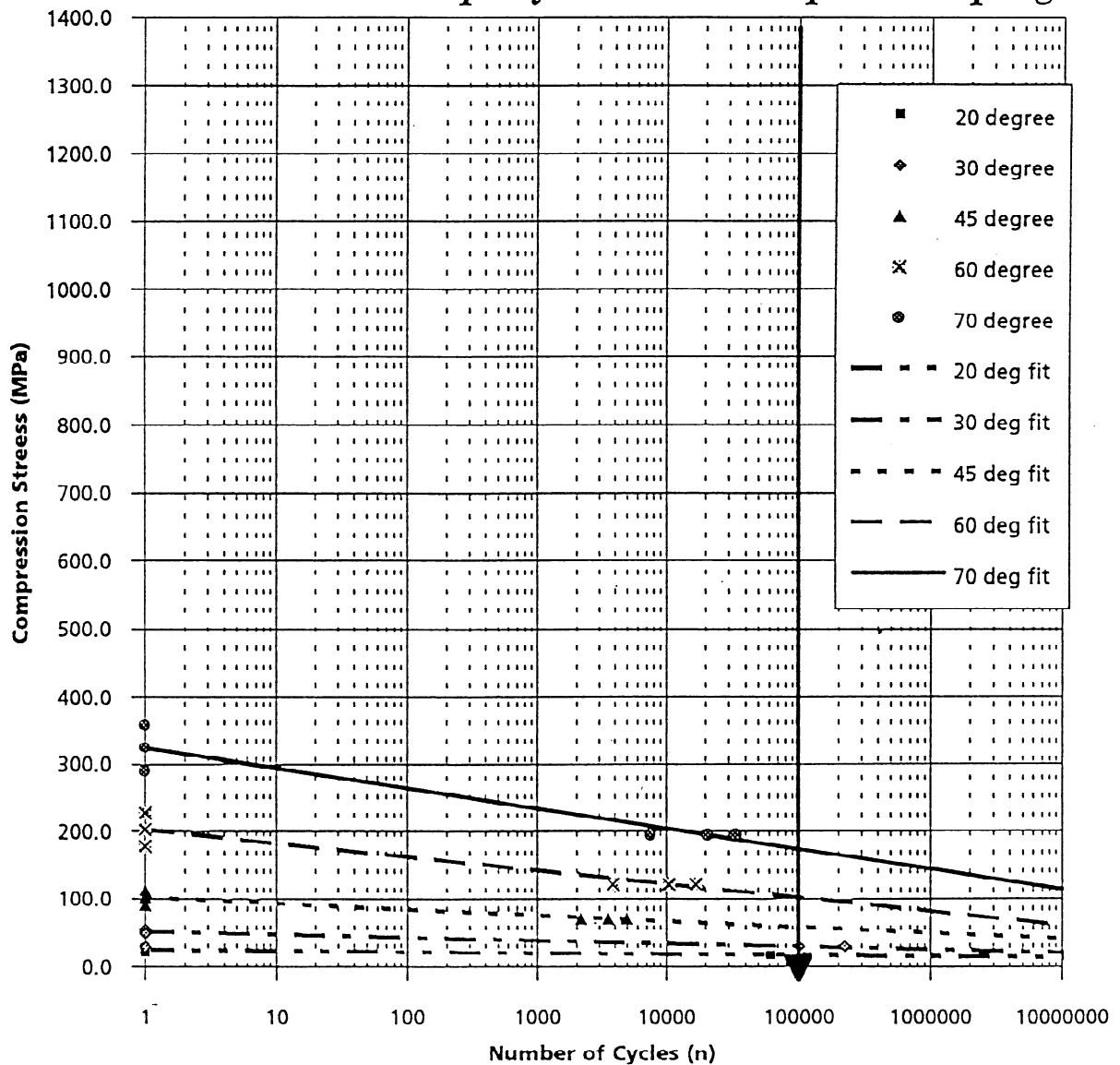

Figure 3.4-17 S-N curve at 77K, load control, R=0.1 for P6 insulation system tested at five test fixture angles plotted versus the compression stress (Ref. [1]).

4 Electrical properties

4.1 Dielectric Strength

The Dielectric strength test method is adapted from ASTM Standard Test Methods D 149-81 and D 3755-79. Limitation in the cryogenic test chamber necessitated the use of smaller

specimens and electrodes. For testing thin laminates, 12.7 mm-diameter electrodes were used with 6.4 mm diameter flats.

All tests were performed at 77K with the specimen fully immersed in liquid nitrogen. Liquid nitrogen is an adequate dielectric fluid and was used to minimize flashover.

Dielectric Strength Definition: The Max. breakdown voltage divided by the specimen thickness.

Note: *Since the dielectric strength of a material does not scale with the material thickness it is necessary to report the specimens thickness.*

Breakdown Definition: An abrupt drop in the applied voltage, which trips the current-sensing circuit of the equipment. It is usually evident by a rupture through the thickness of the specimens. Breakdown is generally confirmed when reapplying the voltage results in a significantly lower breakdown voltage.

Table 4.1-1 illustrates the dielectric strength of Insulation systems for the ITER coils. The samples were tested fully immersed in liquid nitrogen.

Table 4.1-1 Dielectric Strength measured in Liquid Nitrogen

Insulation system	Dielectric Strength (kV/mm)	Specimen thickness (mm)
Vacuum pressure Impregnation resin systems(VPI)		
CTD-101K/S-2 glass (DGEBA) ¹	76.3	0.53
Shell 826/S-2 glass (DGEBA) ¹	83.4	0.652
VPI 1 ² (DGEBA/Aromatic Amine)	58.7	1.43
VPI 5 ² (DGEBF/Liquid Aromatic amine)	36.8	1.42
VPI 6 ² (TGPAP/Aromatic amine)	67.9	1.48
VPI 12 ² (TGPAP/Aromatic amine & Ceramic coating)	45.8	1.9

Pre-impregnated resin systems (prepreg)		
CTD-112/S-2 glass ¹ (TGDM)	79.7	0.552
CTD 112/S-2 Glass with Kapton HA ¹ (TGDM)	81.9	0.596
P4 ² (Epoxy Novolak Prepreg)	55.8	1.12
P6 ² Epoxy Novolak with Kapton	91.6	1.37

1 - Ref. [2], 2 - Ref. [1]

The Dielectric strength of inorganic ceramic coatings is shown in Table 4.1-2. The same testing procedures were used in the inorganic coating tests.

Table 4.1-2 Dielectric Strength of inorganic coating tests in Liquid Nitrogen (Ref. [2])

Insulation system	Dielectric Strength (kV/mm)	Specimen thickness (mm)
Alumina ¹	48.2	0.343
Zirconia ¹	20.7	0.597
Miles enamel ¹	32.6	0.229
Spinel ¹	37.9	0.292

5 Thermal properties

5.1 Thermal Expansion

The Coefficient of Thermal expansion (contraction) was measured in the warp, fill and through thickness directions. The following figures illustrate the EU and US measurements. Note that the data is plotted versus the coefficient of thermal expansion as well as the percent thermal expansion (L_T-L_{295}/L_{295}).

The EUHT measurements were made using a “Quartz Tube Dilatometer”. The Quartz tube transmitted the contraction of the sample at low temperature to a Linear Variable Differential Transformer (LVDT) operating at ambient temperature. Figure 5.1-1 illustrate the test apparatus. The test method was as follows:

- 1) Sample loaded into copper frame and dilatometer assembly.
- 2) Liquid Helium was introduced into the cryostat until the sample temperature was stable at 4.2K.
- 3) The sample was allowed to warm-up over a period of 24 hours while the temperature and LVDT voltage was recorded.

NOTE: The through thickness measurement were made from a stack of 10 samples (~15 mm in length) held together with vacuum grease. The in-plane measurements were made across the parallel edges of the samples (~ 13 x13 mm samples).

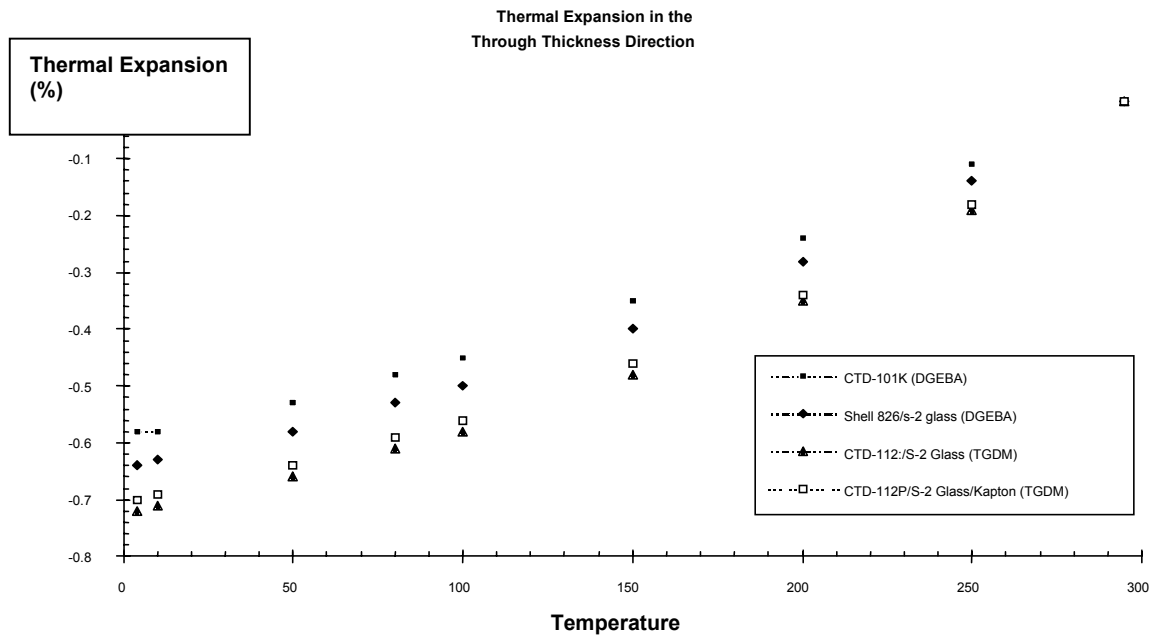

Figure 5.1-2 Thermal expansion % vs Temperature in the Through Thickness direction of the CTD-101K/S-2 glass (DGEBA), Shell 826/S-2 glass, CTD-112P/S-2 glass and CTD-112P/S-2 glass with kapton, from 300 to 4 K (Ref. [2]).

Table 5.1-2 Thermal Expansion in the Through Thickness Direction For VPI and Prepreg insulation systems (Ref. [2]).

Temperature K	Thermal Expansion (Through Thickness Direction)			
	VPI		Prepreg	
	CTD-101K/S-2 glass	Shell 826/S-2 glass	CTD-112P/S- 2 glass	CTD-112P/S- 2 glass/kapton
4	-0.58	-0.64	-0.72	-0.70
10	-0.58	-0.63	-0.71	-0.69
50	-0.53	-0.58	-0.66	-0.64
80	-0.48	-0.53	-0.61	-0.59
100	-0.45	-0.50	-0.58	-0.56
150	-0.35	-0.40	-0.48	-0.46
200	-0.24	-0.28	-0.35	-0.34
250	-0.11	-0.14	-0.19	-0.18
295	0.00	0.00	0.00	0.00

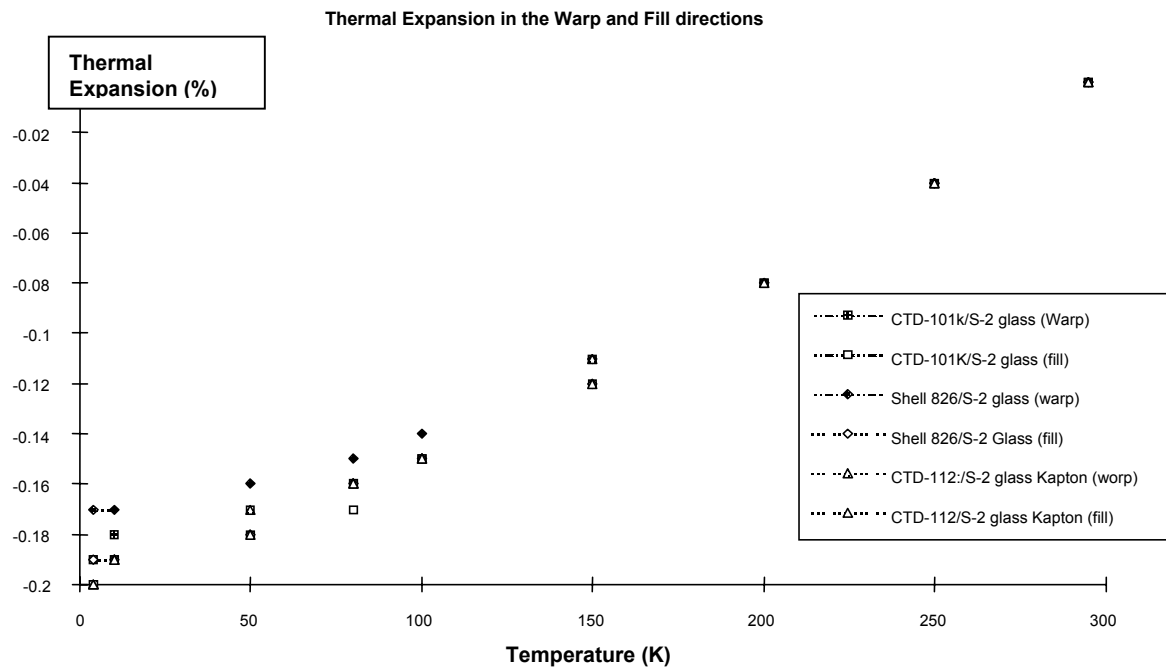

Figure 5.1-3 Thermal expansion (contraction) in the Warp and Fill directions of the CTD-101K/S-2 glass (DGEBA), Shell 826/S-2 glass, and CTD-112P/S-2 glass, from 300 to 4 K

Table 5.1-3 Thermal expansion in the warp and fill directions for VPI and Prepreg insulation systems (Ref. [2])

Temp K	Thermal Expansion							
	VPI				Prepreg			
	CTD-101K/S-2 glass		Shell 826/S-2 glass		CTD-112P/S-2 glass		CTD-112P/S-2 glass/kapton	
	Warp	Fill	Warp	Fill	Warp	Fill	Warp	Fill
4	-0.19	-0.20	-0.17	-0.19	-0.20	-0.20	na	na
10	-0.18	-0.19	-0.17	-0.19	-0.19	-0.19	na	na
50	-0.17	-0.18	-0.16	-0.18	-0.17	-0.18	na	na
80	-0.16	-0.17	-0.15	-0.16	-0.16	-0.16	na	na
100	-0.15	-0.15	-0.14	-0.15	-0.15	-0.15	na	na
150	-0.11	-0.12	-0.11	-0.12	-0.11	-0.12	na	na
200	-0.08	-0.08	-0.08	-0.08	-0.08	-0.08	na	na
250	-0.04	-0.04	-0.04	-0.04	-0.04	-0.04	na	na
295	0.00	0.00	0.00	0.00	0.00	0.00	na	na

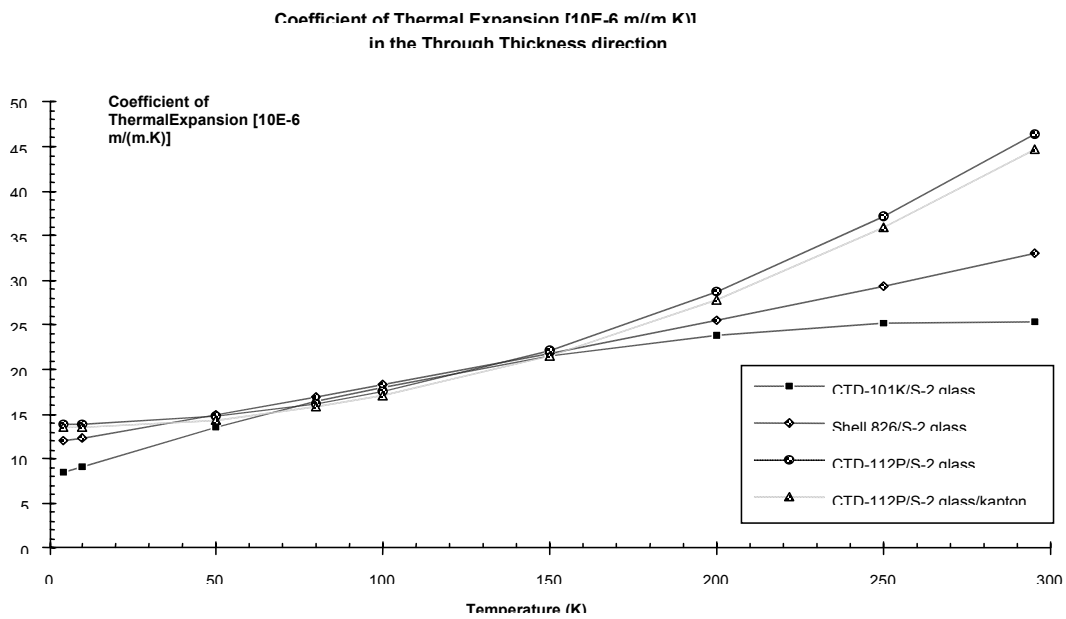

Figure 5.1-4 The Coefficient of thermal expansion (contraction) in the Through Thickness direction of the CTD-101K/S-2 glass (DGEBA), Shell 826/S-2 glass, CTD-112P/S-2 glass and CTD-112P/S-2 glass with kapton, from 300 to 4 K (Ref. [2]).

Table 5.1-4 Coefficient of Thermal Expansion in the through thickness direction for VPI and Prepreg insulation systems (Ref. [2])

Temp K	Thermal Expansion (Through Thickness Direction)			
	VPI		Prepreg	
	CTD-101K/S-2 glass	Shell 826/S-2 glass	CTD-112P/S-2 glass	CTD-112P/S-2 glass/kapton
4	-0.58	-0.64	-0.72	-0.70
10	-0.58	-0.63	-0.71	-0.69
50	-0.53	-0.58	-0.66	-0.64
80	-0.48	-0.53	-0.61	-0.59
100	-0.45	-0.50	-0.58	-0.56
150	-0.35	-0.40	-0.48	-0.46
200	-0.24	-0.28	-0.35	-0.34
250	-0.11	-0.14	-0.19	-0.18
295	0.00	0.00	0.00	0.00

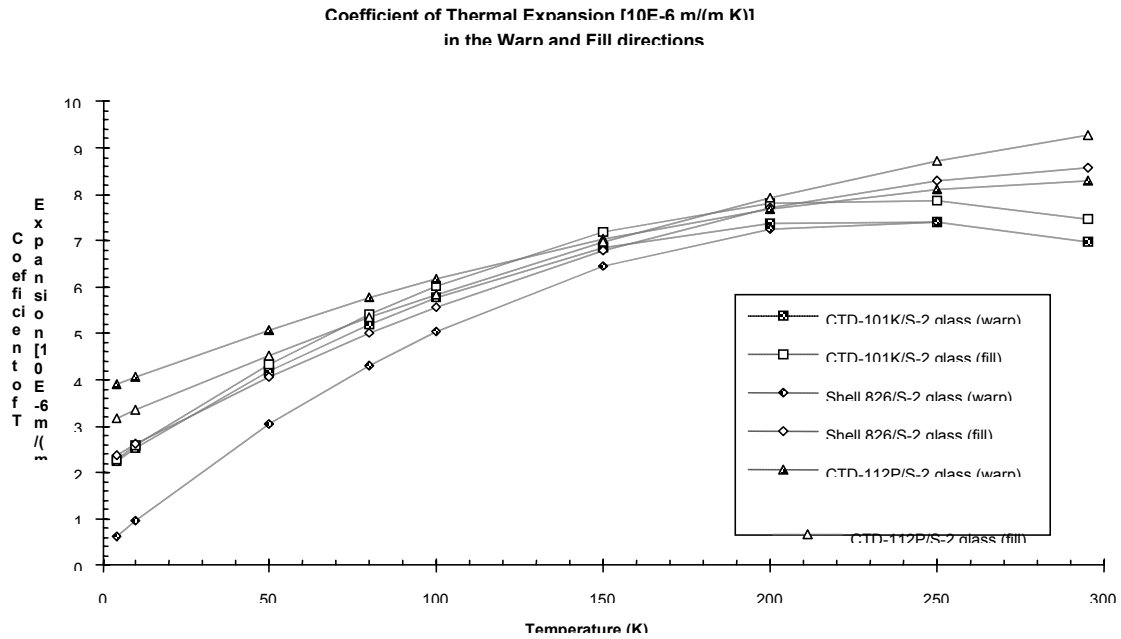

Figure 5.1-5 Coefficient of thermal expansion (contraction) in the Warp and Fill directions of CTD-101K/S-2 glass (DGEBA), Shell 826/S-2 glass, and CTD-112P/S-2 glass, from 300 to 4 K (Ref. [2]).

Table 5.1-5 Coefficient of Thermal Expansion in the Warp and Fill Directions for VPI and Prepreg insulation systems (Ref. [2])

Temp K	Thermal Expansion							
	VPI				Prepreg			
	CTD-101K/S-2 glass		Shell 826/S-2 glass		CTD-112P/S-2 glass		CTD-112P/S-2 glass/kapton	
	Warp	Fill	Warp	Fill	Warp	Fill	Warp	Fill
4	2.25	2.29	0.64	2.38	3.90	3.16	na	na
10	2.53	2.59	0.98	2.61	4.06	3.35	na	na
50	4.18	4.34	3.04	4.05	5.09	4.53	na	na
80	5.20	5.42	4.32	5.01	5.77	5.34	na	na
100	5.77	6.04	5.05	5.58	6.18	5.85	na	na
150	6.84	7.19	6.45	6.80	7.04	6.98	na	na
200	7.38	7.80	7.24	7.70	7.69	7.94	na	na
250	7.40	7.87	7.42	8.30	8.11	8.72	na	na
295	6.97	7.46	7.06	8.58	8.30	9.27	na	na

THROUGH-THICKNESS THERMAL CONTRACTION VPI 1

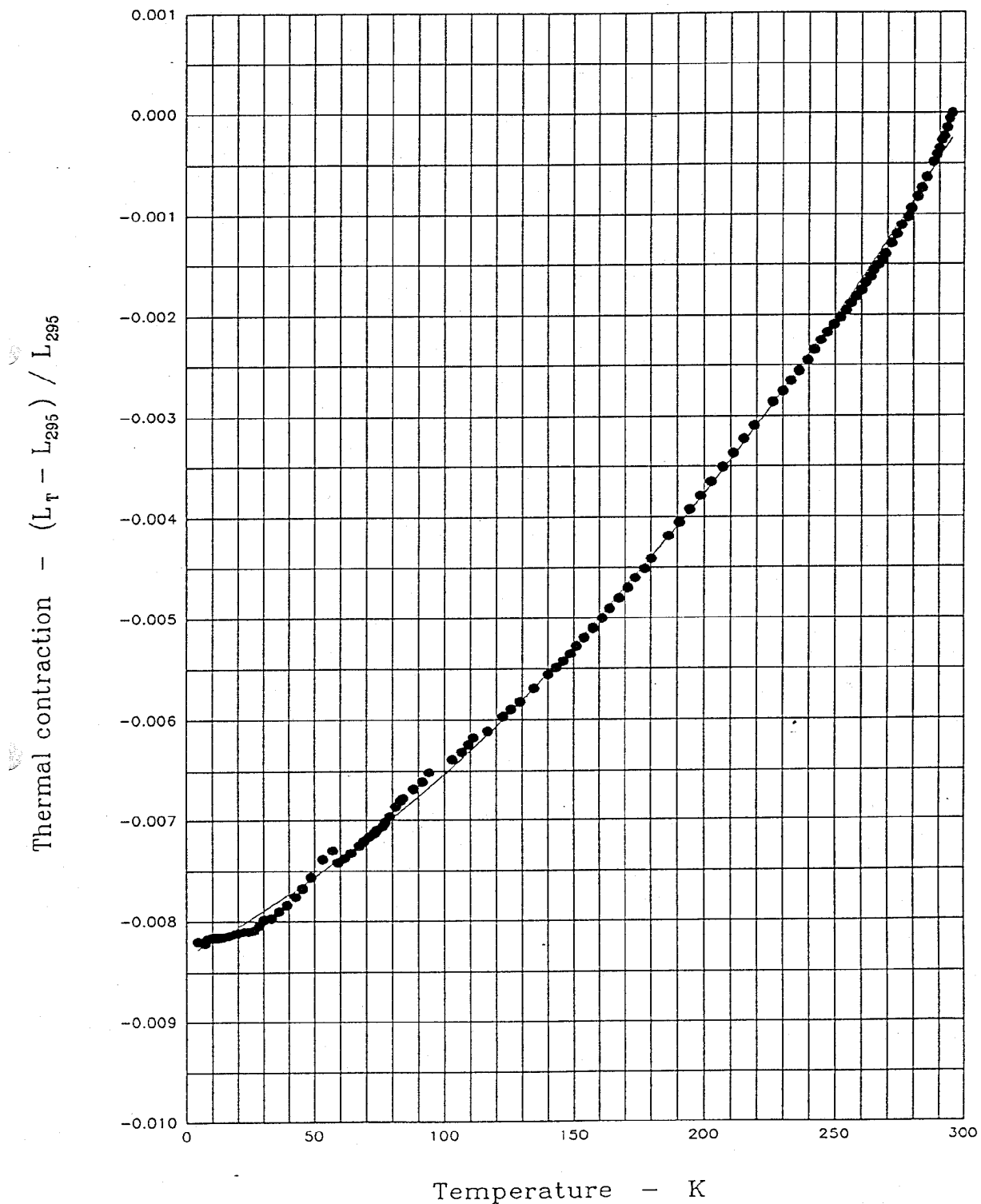

Figure 5.1-6 Thermal Expansion (contraction) in the Through Thickness directions of the VPI 1 (DGEBA/aromatic amine), from 300 to 4 K (Ref. [1]).

THROUGH-THICKNESS THERMAL CONTRACTION VPI 5

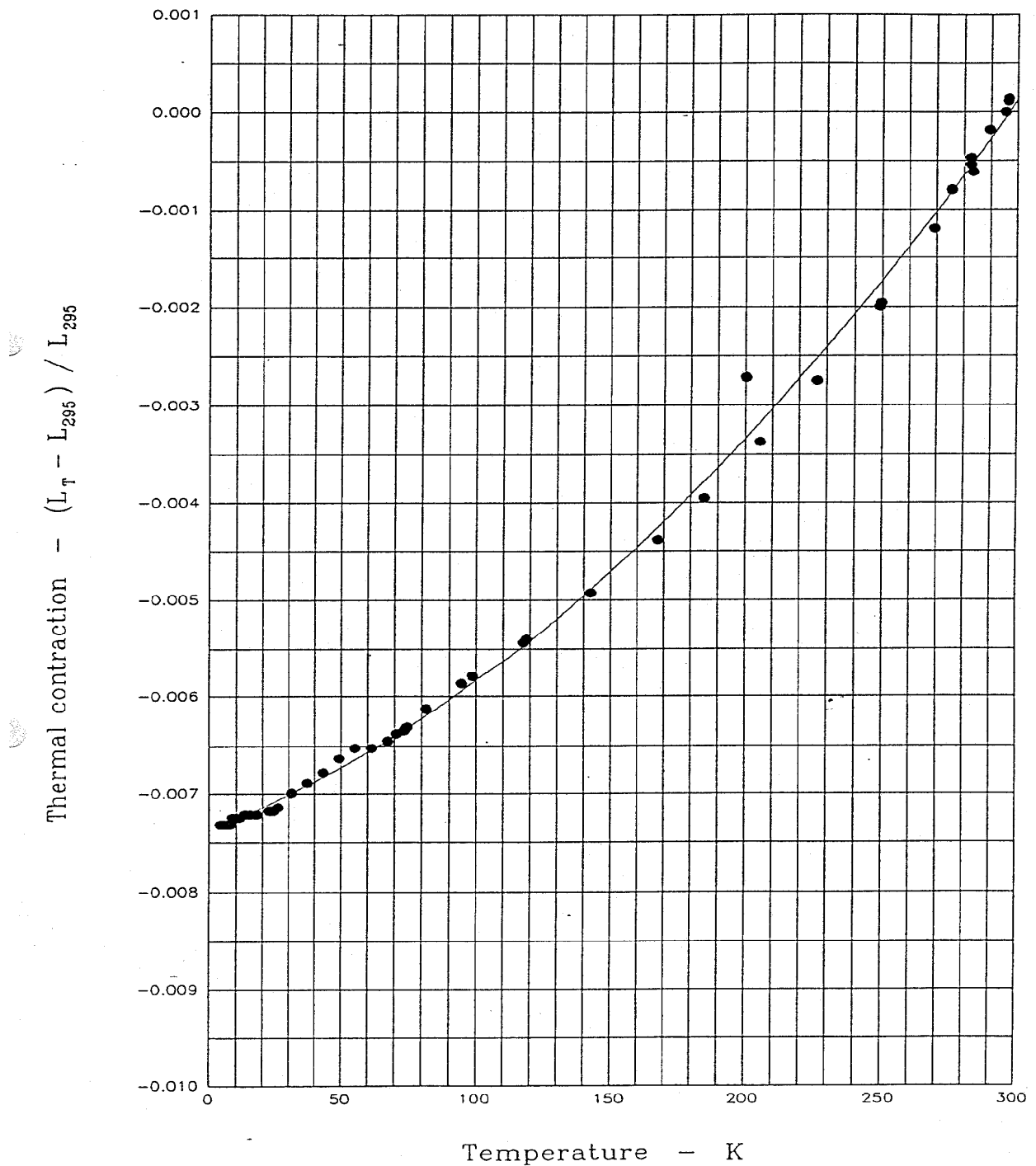

Figure 5.1-7 Thermal Expansion (contraction) in the Through Thickness directions of the VPI 5 (DGEBA/liquid aromatic amine), from 300 to 4K (Ref. [1]).

THROUGH-THICKNESS THERMAL CONTRACTION VPI 6

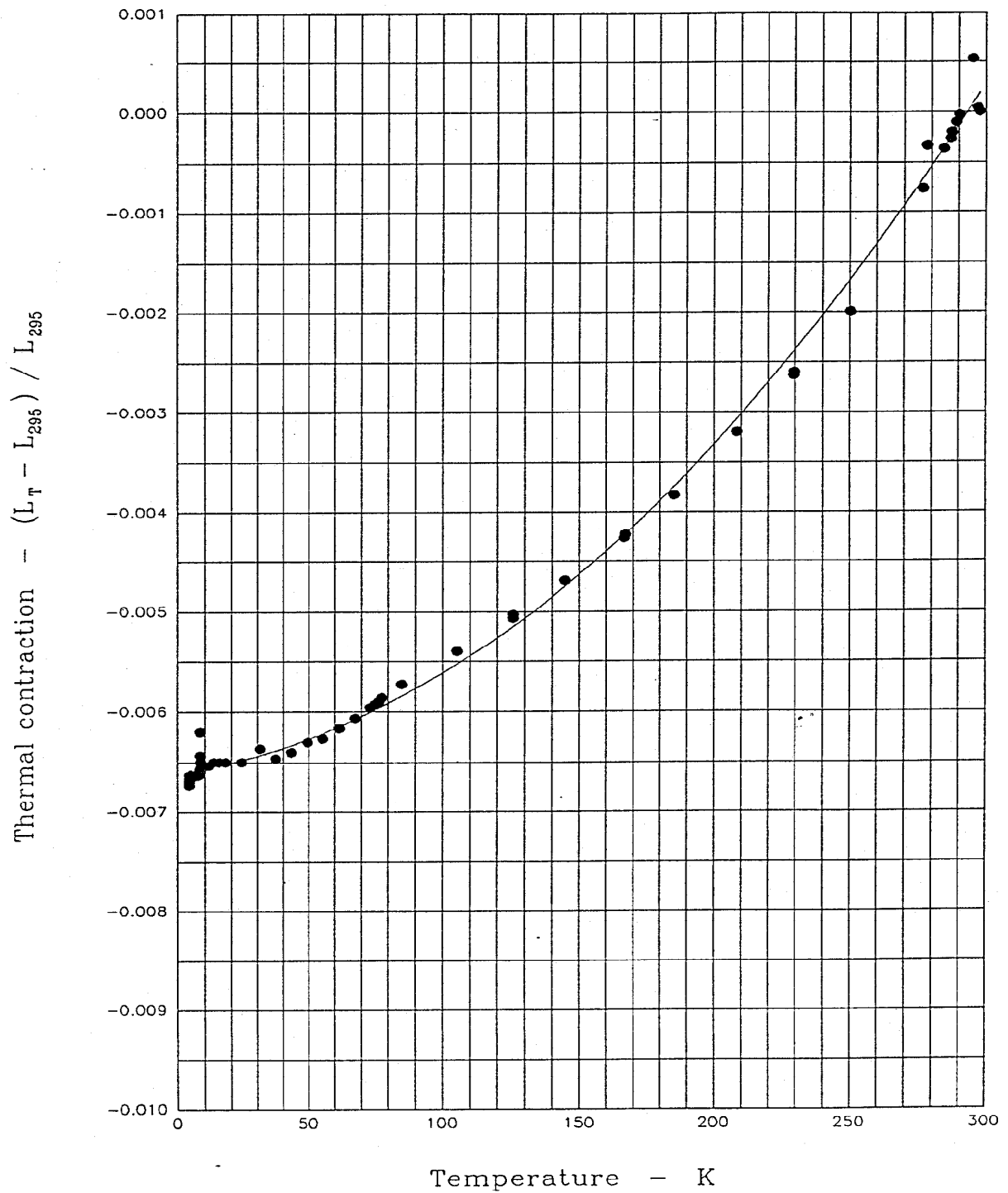

Figure 5.1-8 Thermal Expansion (contraction) in the Through Thickness directions of the VPI 6 (TGPAP/aromatic amine), from 300 to 4 K (Ref. [1])

THROUGH-THICKNESS THERMAL CONTRACTION P 4

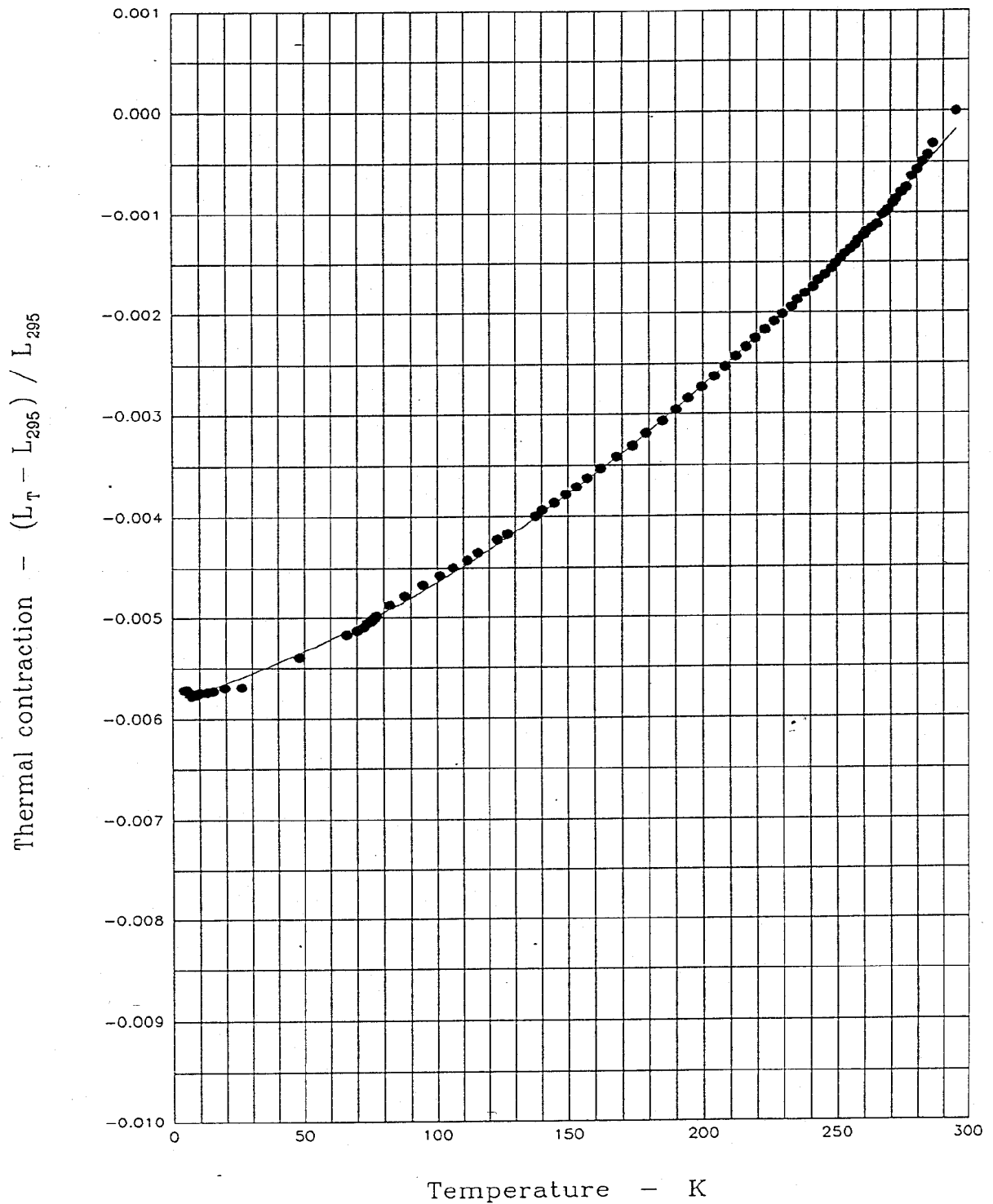

Figure 5.1-9 Thermal Expansion (contraction) in the Through Thickness directions of the P4 (Epoxy Novolak prepreg), from 300 to 4 K (Ref. [1]).

THROUGH-THICKNESS THERMAL CONTRACTION P 6

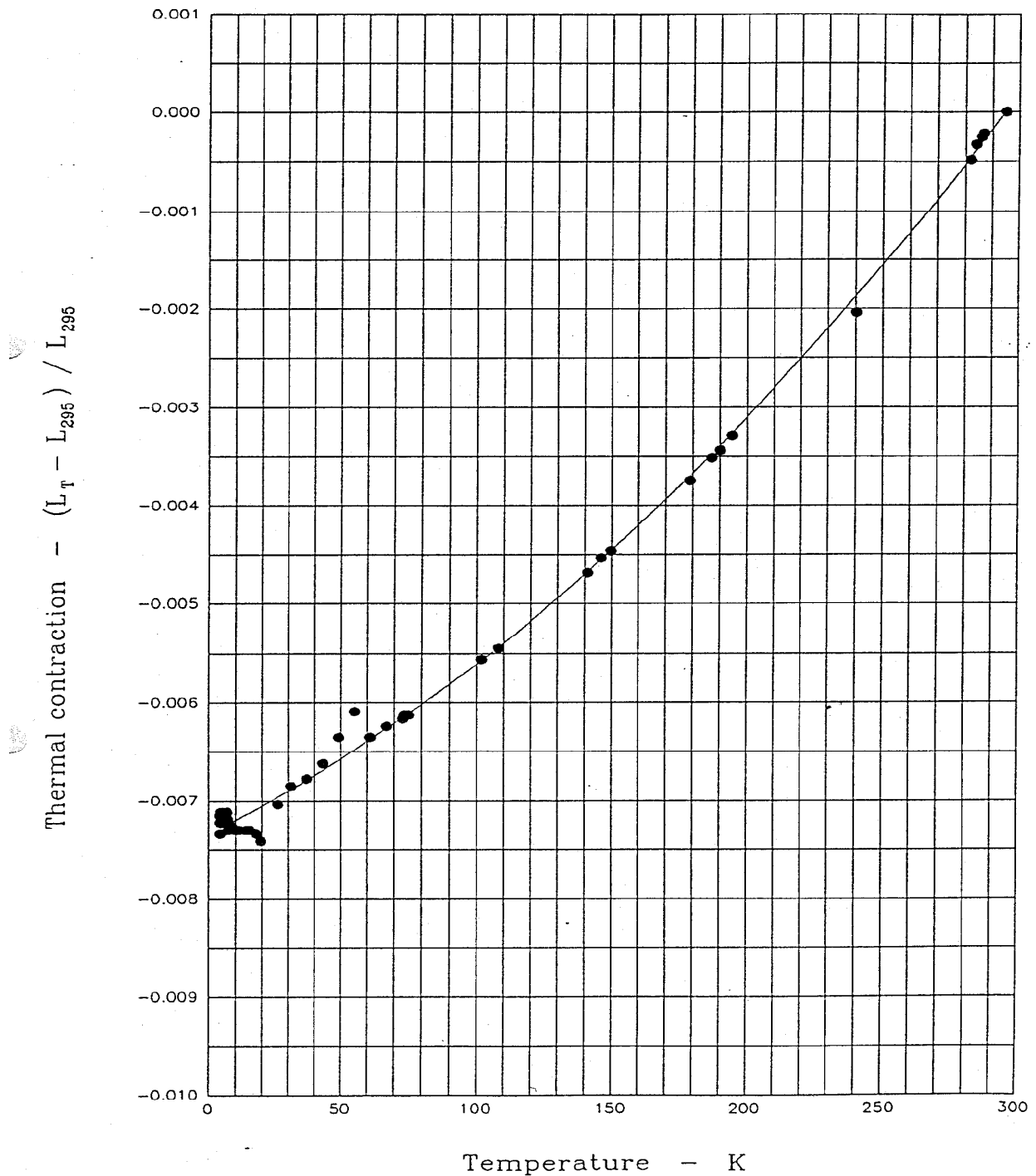

Figure 5.1-10 Thermal Expansion in the Through Thickness directions of the P6 (Epoxy Novolak prepreg with kapton), from 300 to 4 K (Ref. [1]).

5.2 Thermal Conductivity

The Thermal Conductivity for the EUHT samples was tested with the apparatus shown in Figure 5.2-1. Measurements were made in high vacuum at a temperature range from 12 to

300 K. The samples were mounted and tests in pairs. One face of the samples was maintained at the controlled temperature while a controlled heat input was applied to the other faces. The thermal conductivity (k) was then obtained from the temperature differential (dT) which developed across the samples through the relationship (Ref. [1]):

$$k = Q L / A dT$$

A = sample Area (m^2)

L = sample Length (m)

Q = Heat input (W)

The USHT did not provide details of the measuring apparatus used, in its final reports related to Insulation R&D.

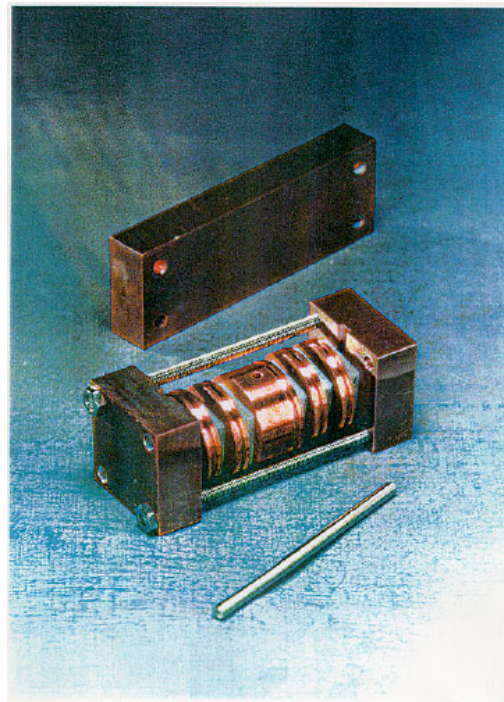
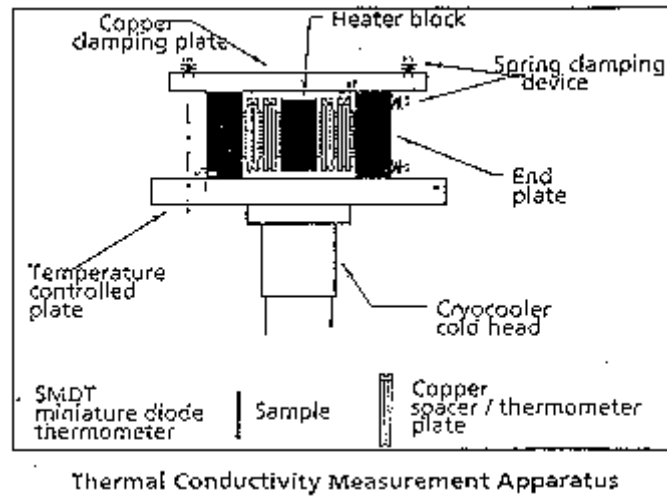

(a) **Figure 5.2-1** a) schematic of the thermal conductivity measurement apparatus;
 (b) **Figure 5.2-1** b) Scan photograph of apparatus (Ref. [1]).

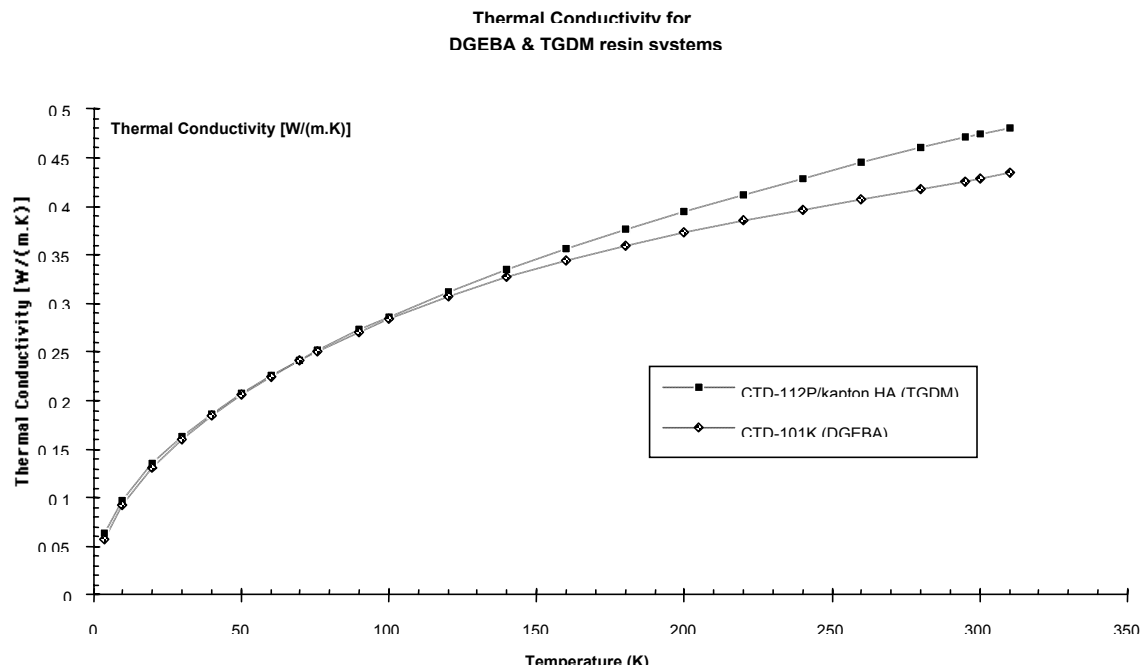

Figure 5.2-1 Thermal Conductivity of CTD-101K/S-2 glass and CTD-112P/S-2 glass with kapton, from 300 to 4 K (Ref. [2]).

Table 5.2-1 Thermal Conductivity of CTD-101K/S-2 glass & CTD-112P/S-2 glass/Kapton (Ref. [2])

Thermal Conductivity [W/(m. K)]		
Temperature (K)	CTD-101K	CTD-112P/ Kapton HA
4	0.057	0.064
10	0.092	0.097
20	0.131	0.135
30	0.160	0.163
40	0.185	0.186
50	0.206	0.207
60	0.225	0.226
70	0.242	0.242
76	0.251	0.252
90	0.271	0.273
100	0.284	0.286
120	0.307	0.312
140	0.327	0.335
160	0.344	0.356
180	0.360	0.376
200	0.373	0.395
220	0.385	0.412
240	0.397	0.429
260	0.407	0.445
280	0.418	0.460
295	0.426	0.471
300	0.428	0.474
310	0.434	0.481

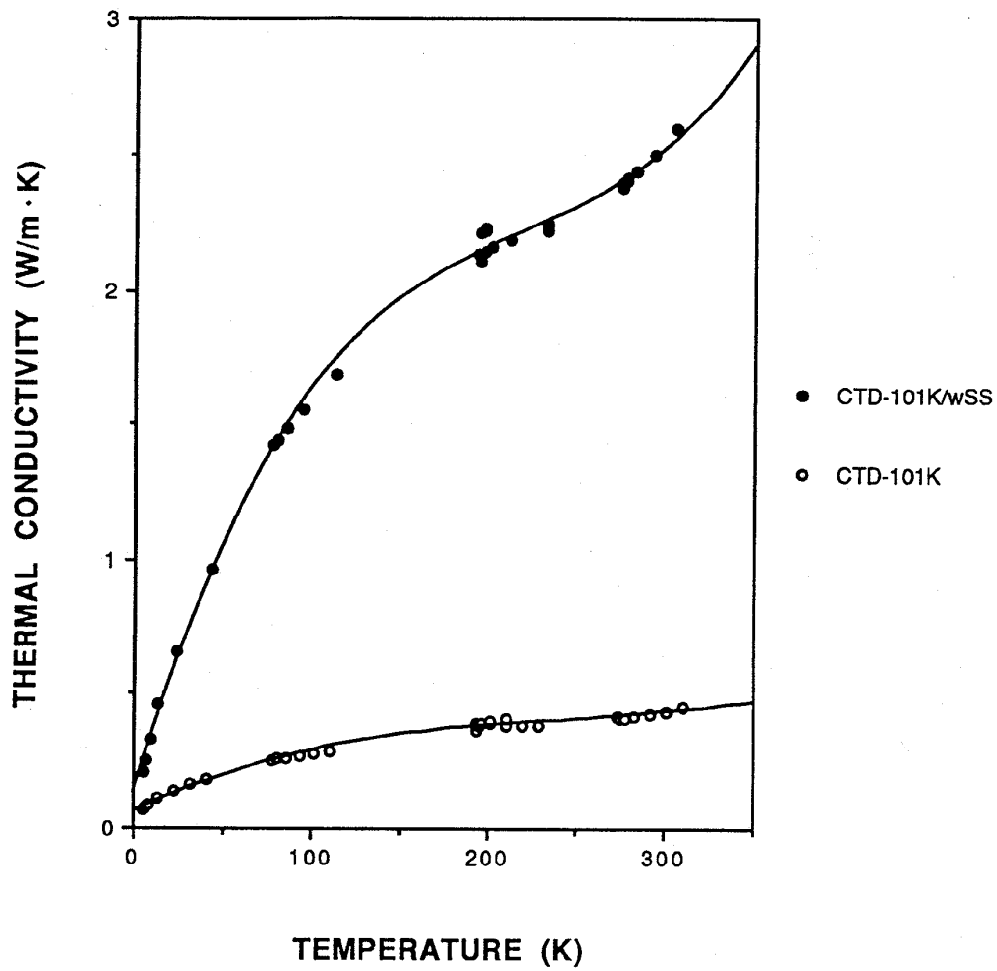

Figure 5.2-2 Compares the thermal conductivity of CTD 101K insulation system with and w/o stainless steel backing (Ref. [2]).

THERMAL CONDUCTIVITY

VPI 1

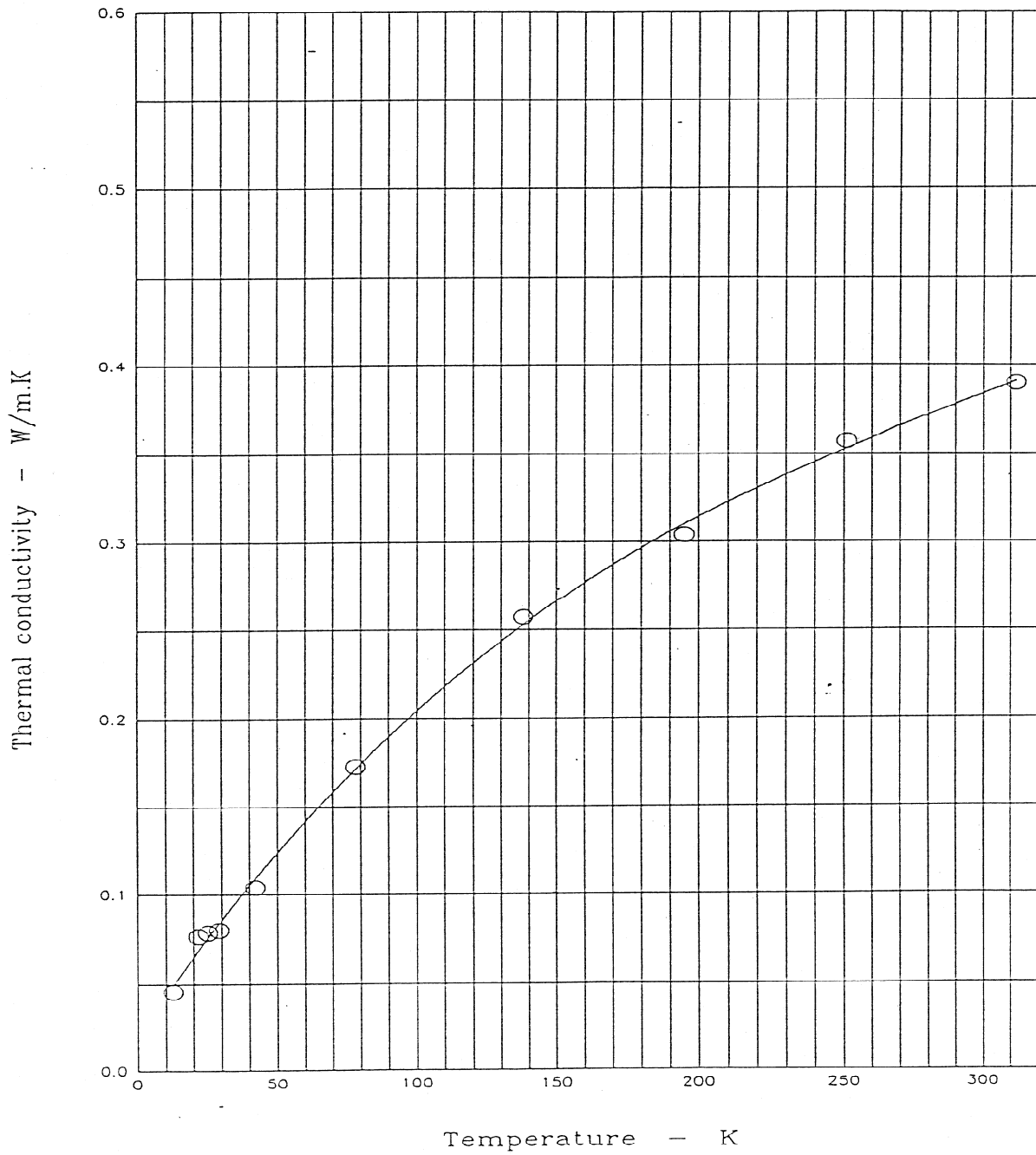

Figure 5.2-3 Thermal conductivity of VPI 1 insulation system in the Through thickness direction from 300 to 4K (Ref. [1]).

THERMAL CONDUCTIVITY

VPI 5

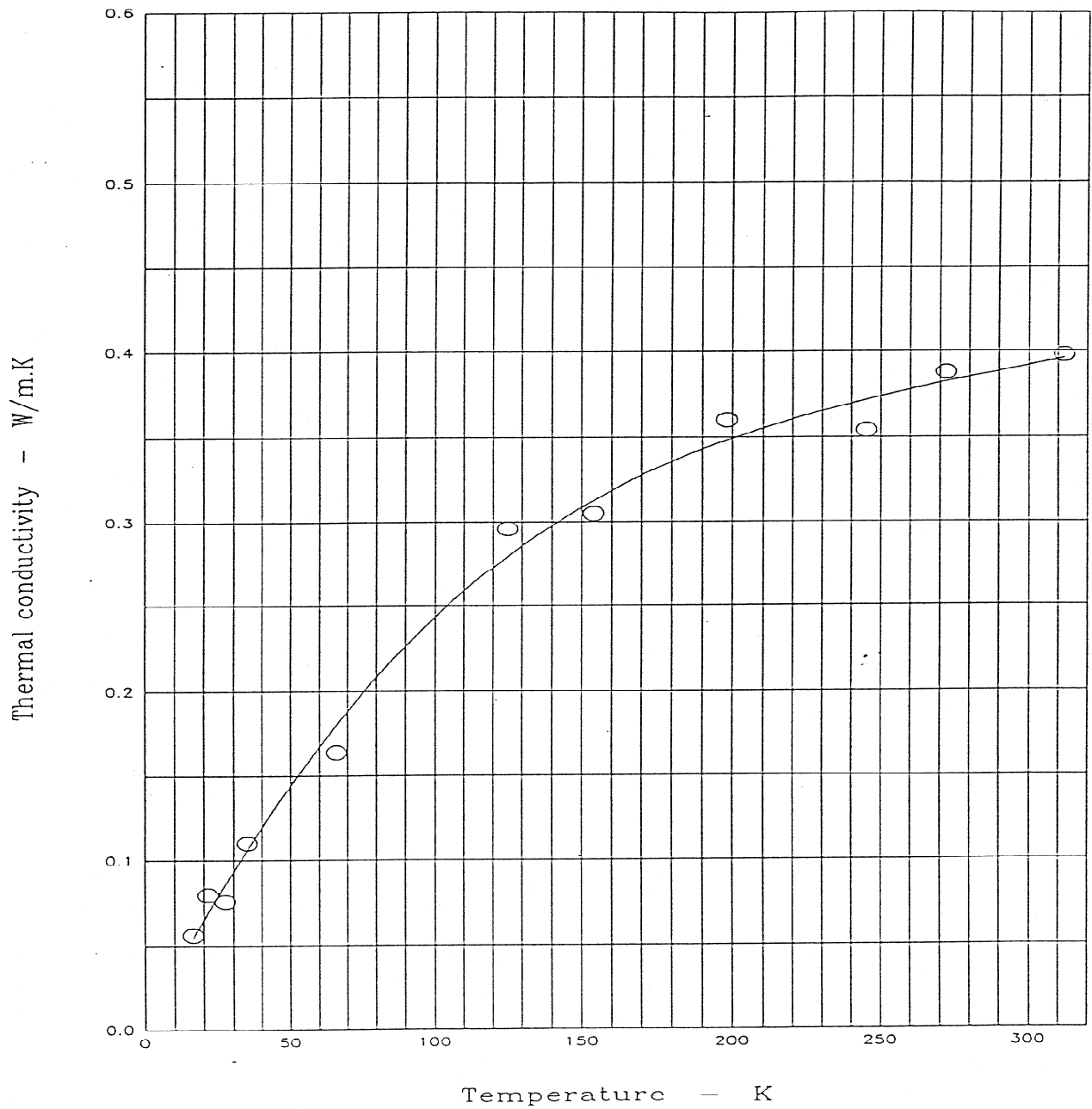

Figure 5.2-4 Thermal conductivity of VPI 5 insulation system in the through thickness direction from 300 to 4 K (Ref. [1]).

THERMAL CONDUCTIVITY

VPI 6

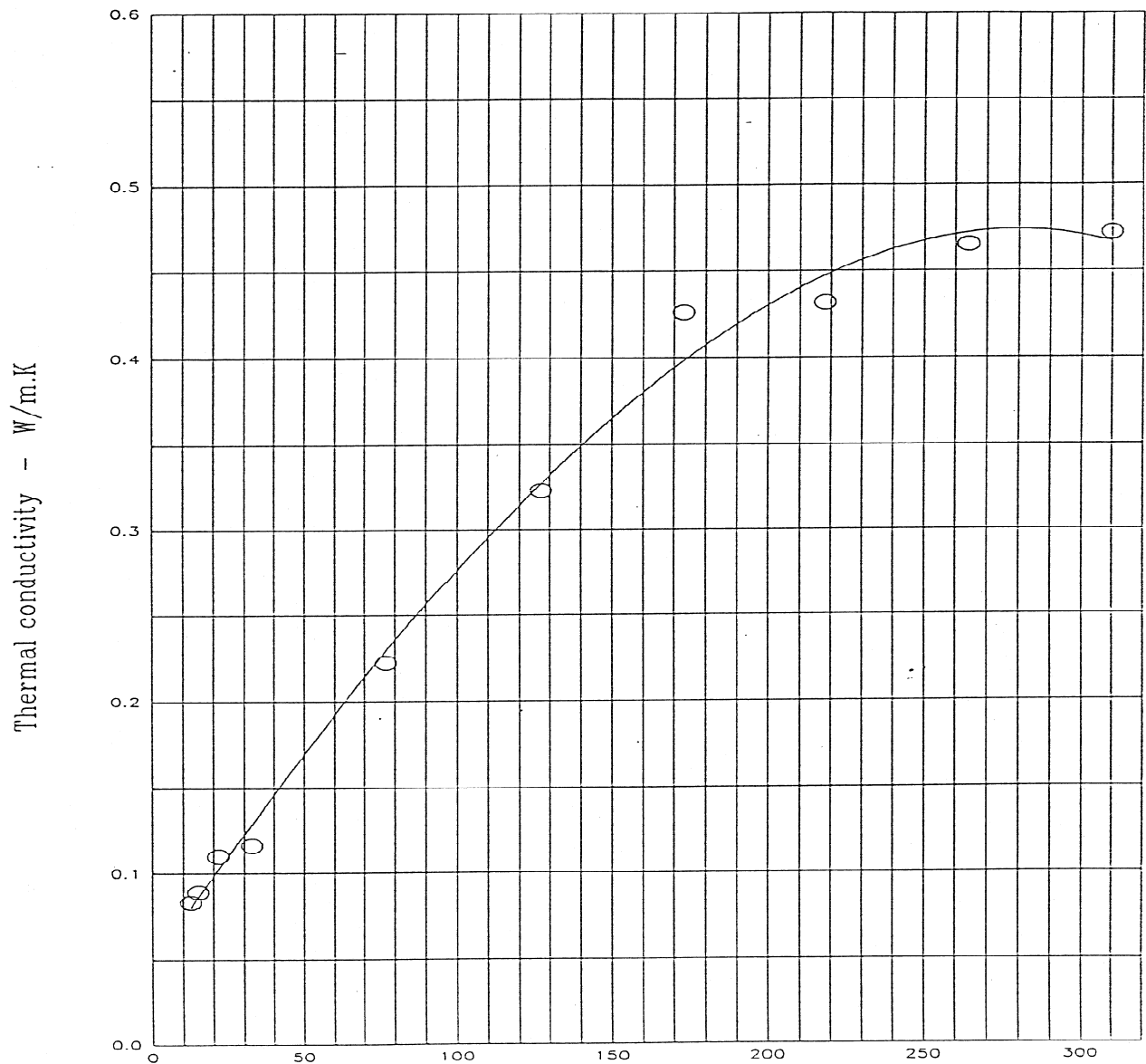

Figure 5.2-5 Thermal conductivity of VPI 6 insulation system in the through thickness direction from 300 to 4 K (Ref. [1]).

THERMAL CONDUCTIVITY

P 4

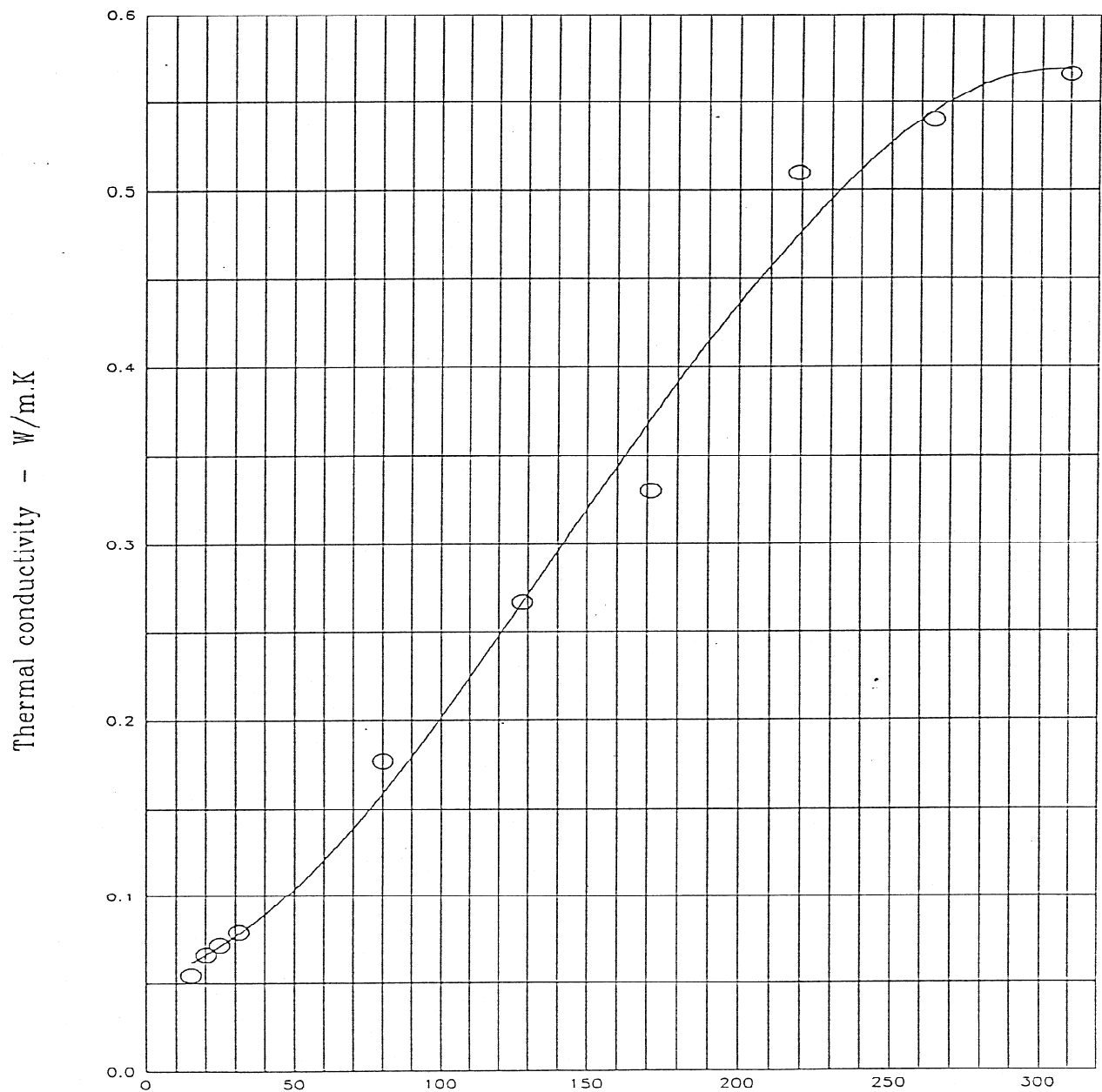

Figure 5.2-6 Thermal conductivity of P4 insulation system in the through thickness direction from 300 to 4K (Ref. [1]).

THERMAL CONDUCTIVITY

P 6

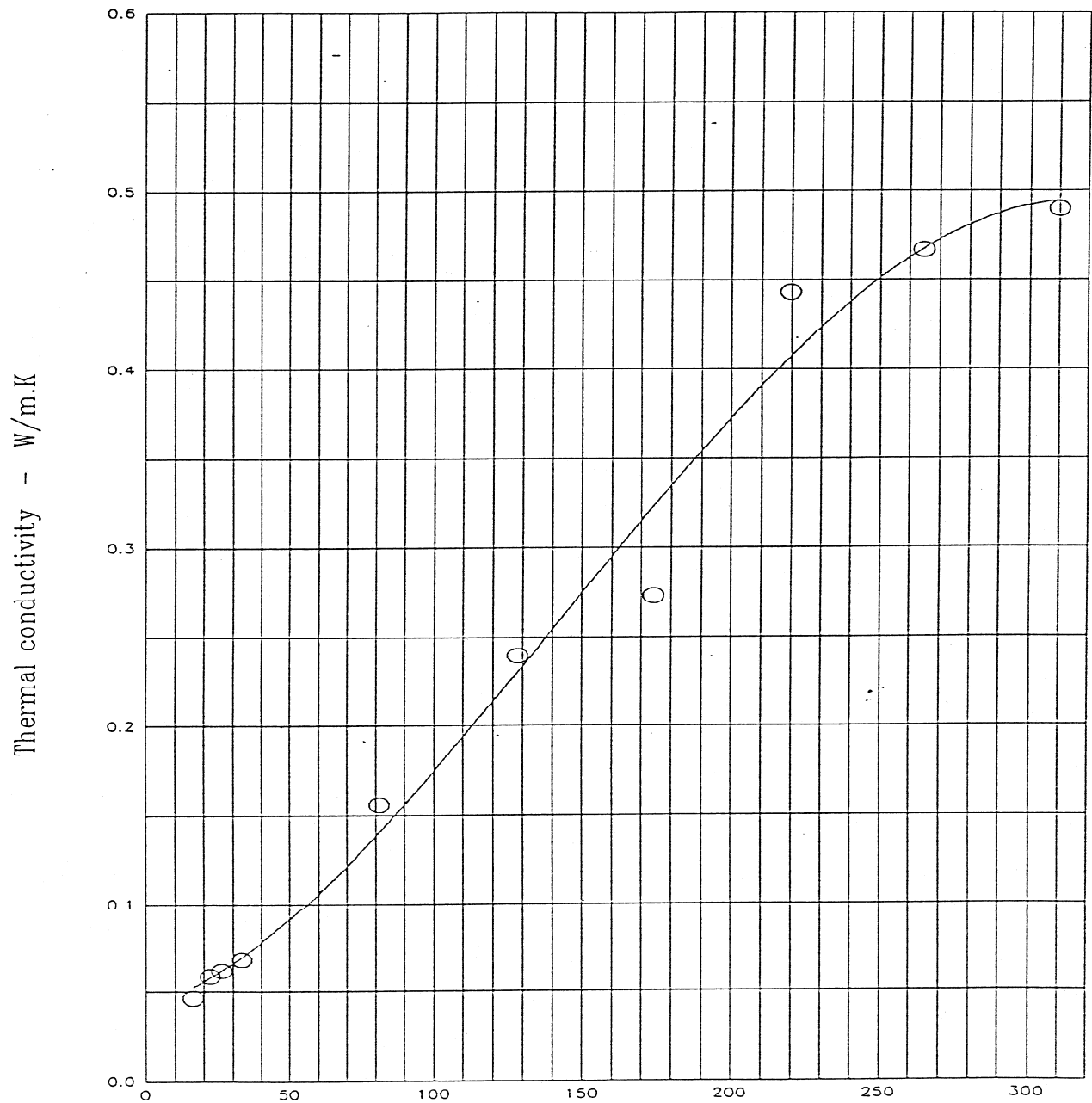

Figure 5.2-7 Thermal conductivity of P6 insulation system in the through thickness direction from 300 to 4K (Ref. [1]).

5.3 Density and Fiber volume

Table 5.3-1 illustrates the density of the insulation systems and the fiber volume fraction, for the selected insulation systems for the ITER coils.

Table 5.3-1 Density and glass fiber volume percent

Insulation Systems	Density (g/cc) at Room Temperature	Fiber volume (%)
Vacuum Pressure Impregnation resin systems (VPI)		
CTD-101K/S-2 glass ¹ (DGEBA)	1.87	54
Shell 826/S-2 glass ¹ (DGEBA)	1.86	55
VPI 1 ² DGEBA/Aromatic Amine	1.8	46.8
VPI 5 ² DGEBF/Liquid Aromatic amine	1.73	50.7
VPI 6 ² TGPAP/Aromatic amine	1.79	45.7
VPI 12 ² TGPAP/Aromatic amine & Ceramic coating	1.79	45.7
Pre-impregnation resin systems (prepreg)		
CTD-112/S-2 glass ¹ (TGDM)	1.77	49
CTD 112/S-2 Glass with Kapton HA ¹ (TGDM)	1.79	50
p4 ² (Epoxy Novolak Prepreg)	1.94	58.7
p6 ² (Epoxy Novolak with Kapton)	1.89	52

1 - Ref. [2], 2 - Ref. [1]

6 Recommended Design Values

6.1 Recommended Mechanical Properties

6.1.1 Compression strength (Through thickness direction)

The recommended through thickness compressive strength for a VPI epoxy-glass (without an interleaved kapton layer) insulation system for the coils with a fiber volume % between 45 & 55 is 1,200 MPa for a temperature range between 77 and 4.2K (see Table 3.1-1).

The recommended through thickness compressive strength for a Prepreg epoxy-glass with an interleave kapton layer insulation system for the coils with a fiber volume % between 45 & 55 is 920 MPa for a temperature range between 77 and 4.2 K (see Table 3.1-1).

Through Thickness: The direction normal to the warp and fill direction of a glass-fiber 2-D composite cloth.

6.1.2 Compression Modulus, Shear Modulus & Poisson's ratio

The recommended warp, fill and through thickness compression, and shear moduli as well as the Poisson's ratio for a VPI and Prepreg (with and with out an interleaved polyimide film [kapton]), insulation systems for coils with a fiber volume % between 45 & 55 are shown in Tables 6.1.2-1 to 4.

Coil manufacturing tolerances increase the variation of the fiber volume % content to a greater range (approximately 30 to 60). For this reason the recommended compression modulus for global coil analysis is 12 GPa for a temperature between 77 and 4.2K.

Table 6.1.2-1 Compressive, Shear and Poisson's ratio Recommended values for a High Pressure Laminate (Ref. [7]).

High Pressure Laminate (G11-CR)				
		Temperature K		
Young's Modulus (GPa)		300	77	4
Warp direction	(E11)	30	36*	37*
Fill direction	(E22)	27	33*	35*
Through thickness	(E33)	16	23*	24*
Shear Modulus (GPa)		300	77	4
In-plane	(G12)	6.8	10.7	11.6
Interlaminar	(G13)	5.7	9.0	9.7**
	(G23)	4.8	7.6	8.2**
Poisson's Ratio		300	77	4
In- plane	(ν_{12})	0.21	0.27	0.27
	(ν_{21})	0.18	0.25	0.25
Other				
	(ν_{13})	0.2	na	na
	(ν_{23})	0.7	na	na
	(ν_{31})	0.11	na	na
	(ν_{32})	0.42	na	na

High Pressure Laminate - *Pre-fabricated epoxy-glass composite sheets* (e.g. G-11CR).

*Estimated from the temperature dependence of tensile E₁₁, E₂₂ & E₃₃ for G-11CR.

**Estimated from the Temperature dependence of G₁₂ of G-11CR.

*** Estimated from the temperature dependence of tensile ν_{12} & ν_{21} and 4K of G-11 CR.

Table 6.1.2-2 Compressive, Shear and Poisson's ratio Recommended values for Prepreg (TGDM epoxy/S-2 glass) (Ref. [7]).

Prepreg (TGDM Epoxy/S-2 Glass)				
		Temperature K		
Young's Modulus (GPa)		300	77	4
Warp direction	(E11)	na	na	na
Fill direction	(E22)	na	na	na
Through thickness	(E33)*	13.6	22.2	24.4
Shear Modulus (GPa)		300	77	4
In-plane	(G12)**	7.3	10.4	11.6
Interlaminar	(G13), (G23)***	3	5.3	6
Poisson's Ratio				
In- plane	(ν_{12})	na	na	na
	(ν_{21})	na	na	na

na not available

*Average from compression tests performed with strain gauges and from shear/compression tested performed at 75 degrees test fixture angle with rosette strain gages.

**From in-plane tensile tests of + - 45 degrees fiber lay-up with strain gages.

***From shear/compression tests performed at 75 degrees test fixture angle with rosette strain gauges.

Table 6.1.2-3 Compressive, Shear and Poisson's ratio Recommended values for Prepreg insulation systems (TGDM epoxy/S-2 glass with Polyimide film [kapton]) (Ref. [7])

Prepreg TGDM Epoxy/S-2 Glass with Polyimide Film(kapton)				
		Temperature K		
Young's Modulus (GPa)		300	77	4
Warp direction	(E11)	na	na	na
Fill direction	(E22)	na	na	na
Through thickness	(E33)*	14.5	20.6	23.6
Shear Modulus (GPa)		300	77	4
In-plane	(G12)	na	na	na
Interlaminar	(G13), (G23)	2.4	3.8	4.4
Poisson's Ratio		300	77	4
In- plane	(ν_{12})	na	na	na
	(ν_{21})	na	na	na

na not available

* From shear/compression tests performed at 75 degrees test fixture angle with rosette strain gages, with 3 layers of ~0.025 mm thick kapton film.

Table 6.1.2-4 Compressive, Shear and Poisson's ratio Recommended values for VPI insulation system (DGEBA epoxy/S-2 glass) (Ref. [7])

VPI (DGEBA Epoxy/S-2 Glass)				
		Temperature K		
Young's Modulus (GPa)		300	77	4
Warp direction	(E11)	na	na	na
Fill direction	(E22)	na	na	na
Through thickness	(E33)*	12.6	20.7	23.6
Shear Modulus (GPa)		300	77	4
In-plane	(G12)**	4.4	9.6	10.7
Interlaminar	(G13), (G23)**	4.1	6.9	7.6
Poisson's Ratio		300	77	4
In- plane	(ν_{12})	na	na	na
	(ν_{21})	na	na	na

* From compression tests with strain gauges.

** From in-plane tensile tests with + - 45 degrees fiber lay-up with strain gauges.

6.1.3 Interlaminar Shear Strength

The recommended Static & fatigue interlaminar shear strength for a VPI and Prepreg epoxy-glass (with and without an interleaved polyimide film [kapton] layer) insulation system with a fiber volume % between 45 & 55 are shown in Table 6.1.3-1.

Table 6.1.3-1

Static VPI Insulation System w/o Polyimide film (kapton)	
Static	85 MPa
Fatigue	50 MPa
Prepreg insulation systems with polyimide film(kapton)	
Static	40 MPa
Fatigue*	40 MPa

* - With or w/o etching of the polyimide film.

The interlaminar shear strength was determined at the intercept of the shear/compression data to the vertical axis where the compression stress is zero, see Figures 6.2-1 to 4. The intercept point is determined by taking the slope of the 4.2K data and extending it to the y-axis, for the cases where 4.2K data is not available the average of the 77K slope was selected. The lack of fatigue data for the Prepreg with polyimide film insulation systems necessitated the selection of conservative values.

6.1.4 Shear/Compression Strength

The recommended Static and Fatigue shear/compression values for VPI and Prepreg insulation systems with and without an interleave polyimide film (kapton) and with a fiber volume % of 45 to 55 are shown in the Table 6.1.4-1.

Table 6.1.4-1 Recommended values for Static & fatigue for VPI and Prepreg insulation systems

VPI Static		
Shear stress MPa	Compression stress MPa	Slope Coefficient (C ₂)
85	0	0.45
164	164	
164	400	
Prepreg/kapton Static		
Shear stress MPa	Compression stress MPa	Slope Coefficient (C ₂)
40	0	0.6
100	100	
100	400	
VPI Fatigue		
Shear stress MPa	Compression stress MPa	Slope Coefficient (C ₂)
50	0	0.45
100	100	
100	400	
Prepreg/kapton Fatigue		
Shear stress MPa	Compression stress MPa	Slope Coefficient (C ₂)
40	0	0.32
59	59	
59	400	
Prepreg/etched kapton fatigue		
Shear stress MPa	Compression stress MPa	Slope Coefficient (C ₂)
40	0	0.51
82	82	
82	400	

The following Figures 6.1.4-1 to 4 illustrates the recommended values shown in the above table, plotted on shear versus compression strength for VPI and prepreg insulation system of the EU, JA and US HTs data taken at 77 and 4.2K.

Table 6.1.4-2 Recommended Fatigue (5×10^4 cycles) Through Thickness Compression Strength for Low voltage Application at 4.2K

Material	Ultimate Compressive Strength
VPI epoxy-glass (without an interleaved kapton layer)	1,200
VPI epoxy-glass with ceramic coating	1,100

The recommended fatigue (5×10^4 cycles) compressive Primary and Peak stresses for low voltage application of VPI, VPI/ceramic coating and Prepreg epoxy-glass-kapton insulation systems with a fiber volume % between 45 & 55 are shown in Table 6.1.4-2 (safety factors of 2 and 1.5 on the ultimate strength have been applied for primary and peak stresses respectively).

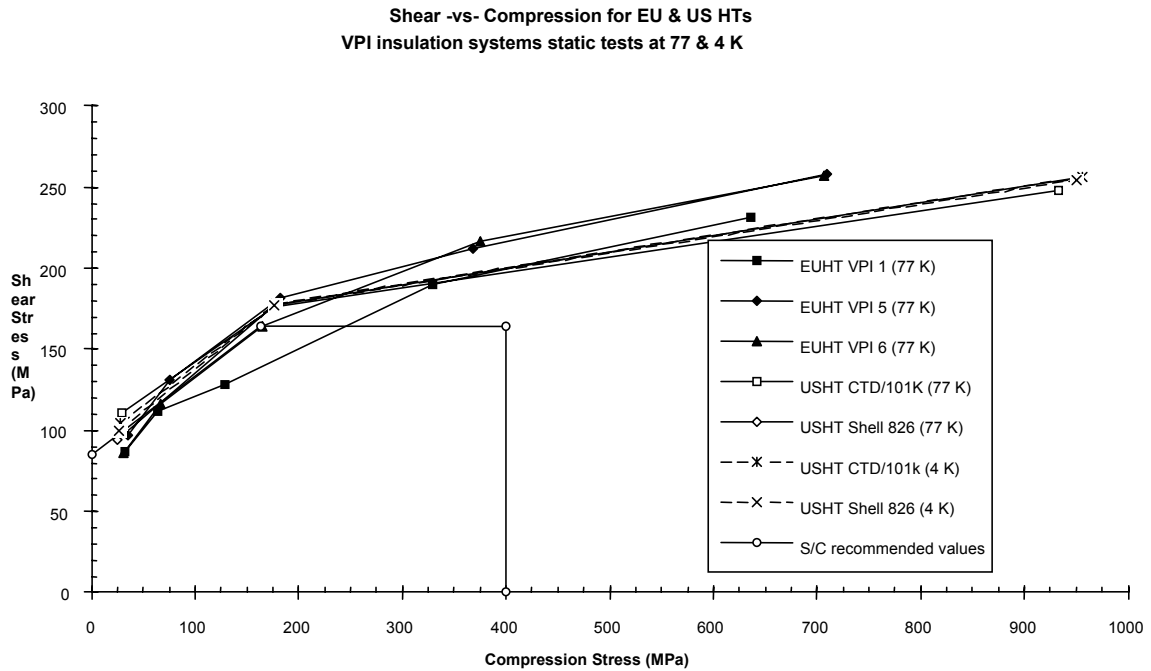

Figure 6.1.4-1 Plot of Static shear versus compression strength for EU and US HTs VPI insulation systems tested at 77 & 4 K (Ref. [1] & [2])

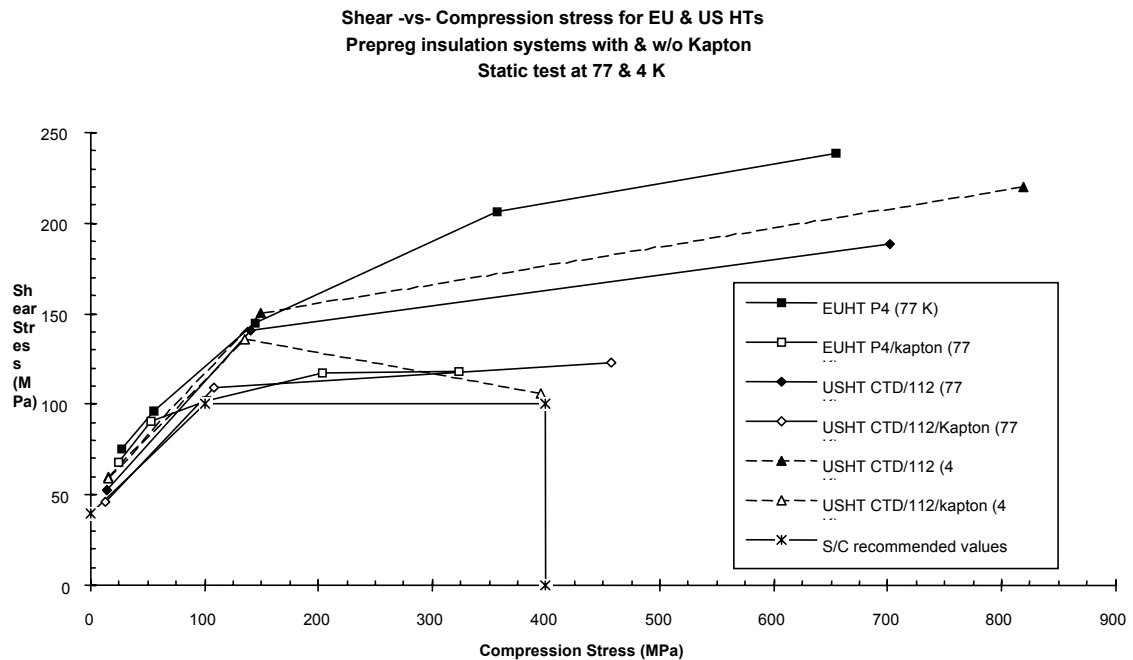

Figure 6.2-2 Plot of Static shear versus compression strength of EU and US HTs Prepreg insulation systems tested at 77 and 4K (Ref. [1] & [2])

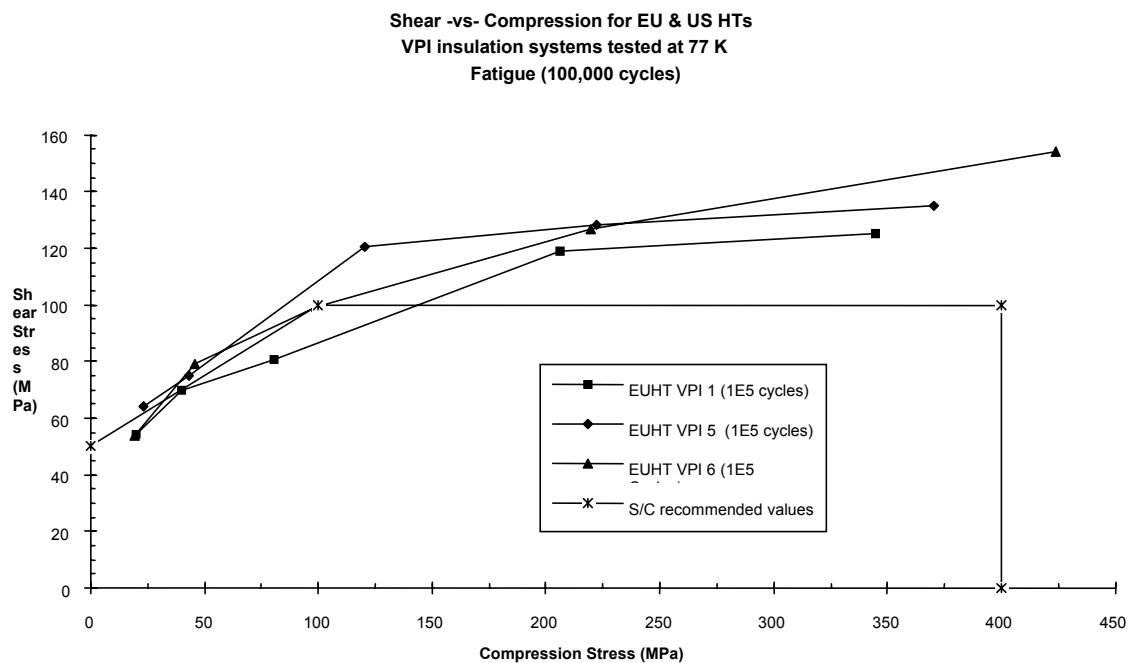

Figure 6.1.4-3 Plot of Fatigue (1×10^5 cycles) shear versus compression strength of the EU and US HTs VPI insulation systems tested at 77K (Ref. [1] & [6]).

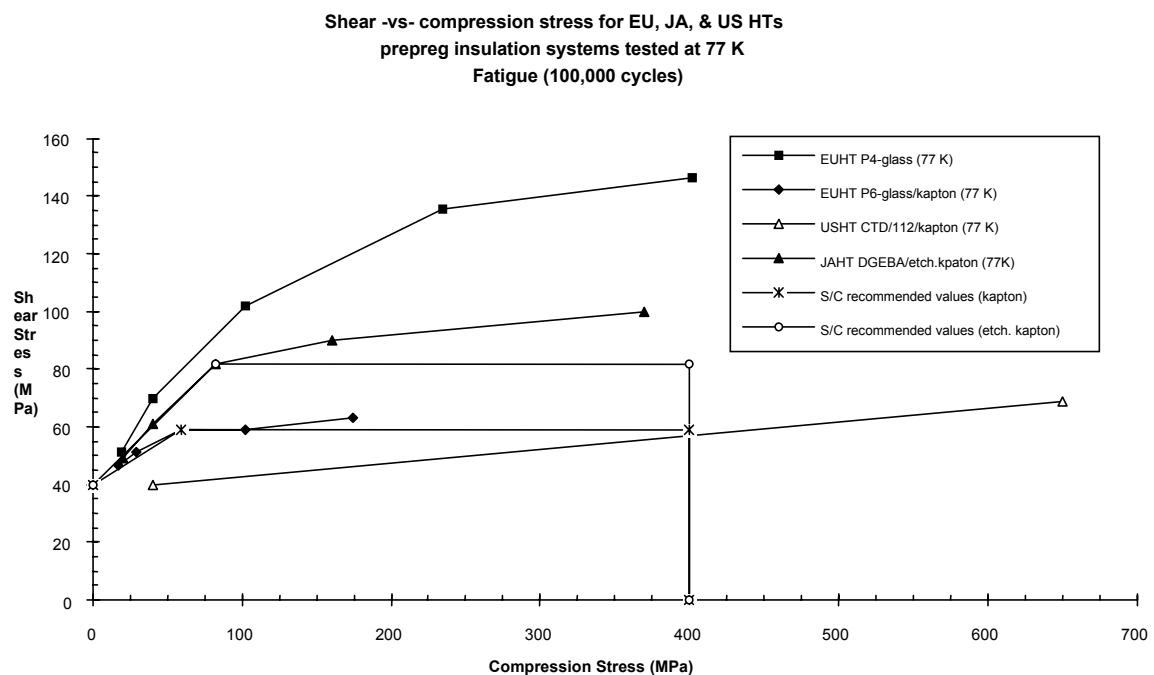

Figure 6.1.4-4 Plot of Fatigue (1×10^5 cycles) shear versus compression strength of the EU and US HTs Prepreg insulation systems tested at 77K (Ref. [1] & [6]).

6.2 Electrical Properties

6.2.1 Dielectric Strength

The recommended electric field (kV/mm) across an epoxy glass fiber reinforced composite shall not exceed 30 kV/mm. Factor of safety are not included in this value, for design purposes please see Appendix C III Electric Design Criteria.

6.2.2 Dielectric Strength for Inorganic Insulation Systems

The recommended electric field (kV/mm) for inorganic insulation systems shall not exceed 15 kV/mm. Factor of safety are not included in this value, for design purpose please see Appendix C III Electric Design Criteria.

6.3 Thermal Properties

6.3.1 Thermal Expansions

The recommended through thickness thermal expansion/contraction properties from 300 to 4 K for a VPI epoxy-glass insulation system with a fiber volume % between 45 & 55% is VPI 5 shown in Figure 5.1-7. Note that the thermal expansion/contraction of these insulation systems in the warp and fill directions do not vary significantly Figure 5.1-3.

Table 6.3.1-1

VPI 5 EUHT		
Temperature K	Thermal Expansion (%)	Thermal Exp. Coefficient [10E6 m/(m.k)]
4	-0.73	na
10	-0.72	na
50	-0.67	na
80	-0.625	na
100	-0.59	na
150	-0.47	na
200	-0.34	na
250	-0.17	na
295	0.00	na

na- not available

The recommended through thickness thermal expansion/contraction properties from 300 to 4K for a prepreg epoxy-glass insulation system with a fiber volume % between 45 & 55 is CTD-112P/s-2 glass/kapton (TGDM) shown in Figure 5.1-2). Note that the thermal expansion/contraction of this insulation system in the warp and fill directions do not vary significantly Figure 5.1-3.

Table 6.3.1-2

CTD-112P/s-2 glass/kapton (TGDM)		
Temperature K	Thermal Expansion (%)	Thermal Exp. Coefficient [10E6 m/(m.k)]
4	-0.73	na
10	-0.72	na
50	-0.67	na
80	-0.625	na
100	-0.59	na
150	-0.47	na
200	-0.34	na
250	-0.17	na
295	0.00	na

na - not available

6.3.2 Thermal Conductivity

The recommended thermal conductivity from 300 to 4 K for a VPI and prepreg epoxy-glass insulation systems with a fiber volume % between 45 & 55 % are CTD-101K (DGEBA) and CTD-112p/kapton (TGDM) respectively. (See Figure 5.2-1).

Table 6.3.2-1 Thermal Conductivity of CTD-101K/S-2 glass & CTD-112P/S-2 glass/Kapton (USHT)

Thermal Conductivity [W/(m. K)]		
Temperature K	CTD-101K	CTD- 112P/Kapton HA
4	0.057	0.064
10	0.092	0.097
20	0.131	0.135
30	0.160	0.163
40	0.185	0.186
50	0.206	0.207
60	0.225	0.226
70	0.242	0.242
76	0.251	0.252
90	0.271	0.273
100	0.284	0.286
120	0.307	0.312
140	0.327	0.335
160	0.344	0.356
180	0.360	0.376
200	0.373	0.395
220	0.385	0.412
240	0.397	0.429
260	0.407	0.445
280	0.418	0.460
295	0.426	0.471
300	0.428	0.474
310	0.434	0.481

6.3.3 Density and Fibre Volume

The recommended Fiber volume content for VPI and prepreg epoxy-glass systems is 45 to 55% Table 5.3-1.

However specific design requirements may need insulation system with different fiber volume % requirements. In such cases the specifics of that particular application will have to be evaluated.

7 References

1. A. J. Broadbent, "Report of the Screening Tests of Insulation Material for the International Thermonuclear Experimental Reactor (ITER)", Published: May 1995, Oxford Instruments Inc., Special Project, England
2. P. E. Fabian¹, R. P. Reed², "Candidate ITER Insulation Materials Characterization Report", Published: January 1994, ¹Composite Technology Development, Inc., ²Cryogenic Materials, Inc., USA
3. D. Evans and R. P. Reed, "Gas Evolution from Potential ITER Insulating Materials Optimization of Formulating Variables", Published: September 1995, Cryogenic Materials, Inc., USA
4. Paul E. Fabian¹, James B. Schutz¹, Craig S. Hazelton¹, R. P. Reed², "Screening of Candidate Insulation Systems for ITER TF Coils", Published: August 1993, ¹Composite Technology Development, Inc., ²Cryogenic Materials, Inc., USA
5. James B. Schutz¹, R. P. Reed², "Inorganic and Hybrid Insulation Materials for ITER", Published: July 1994, ¹Composite Technology Development, Inc., ²Cryogenic Materials, Inc., USA
6. R. P. Reed¹, P. E. Fabian², and T. S. Bauer-McDaniel², "Shear/Compression Fatigue of Insulation Systems at Low Temperatures", Published: International Cryogenics Materials Conference, Honolulu, Hawaii, October 1994 volume 35. ¹Cryogenic Materials, Inc., ²Composite Technology Development, Inc., USA
7. R. P. Reed¹, P. E. Fabian², and T. S. Bauer-McDaniel², "Elastic Properties of Composite ITER Insulation Systems", ¹Cryogenic Materials, Inc., ²Composite Technology Development, Inc., USA