

# Engineering Meeting

October 18, 2000

Presented by Mike Cole

Dave Williamson, Brad  
Nelson, D. Strickler

3 co 1 counter NB

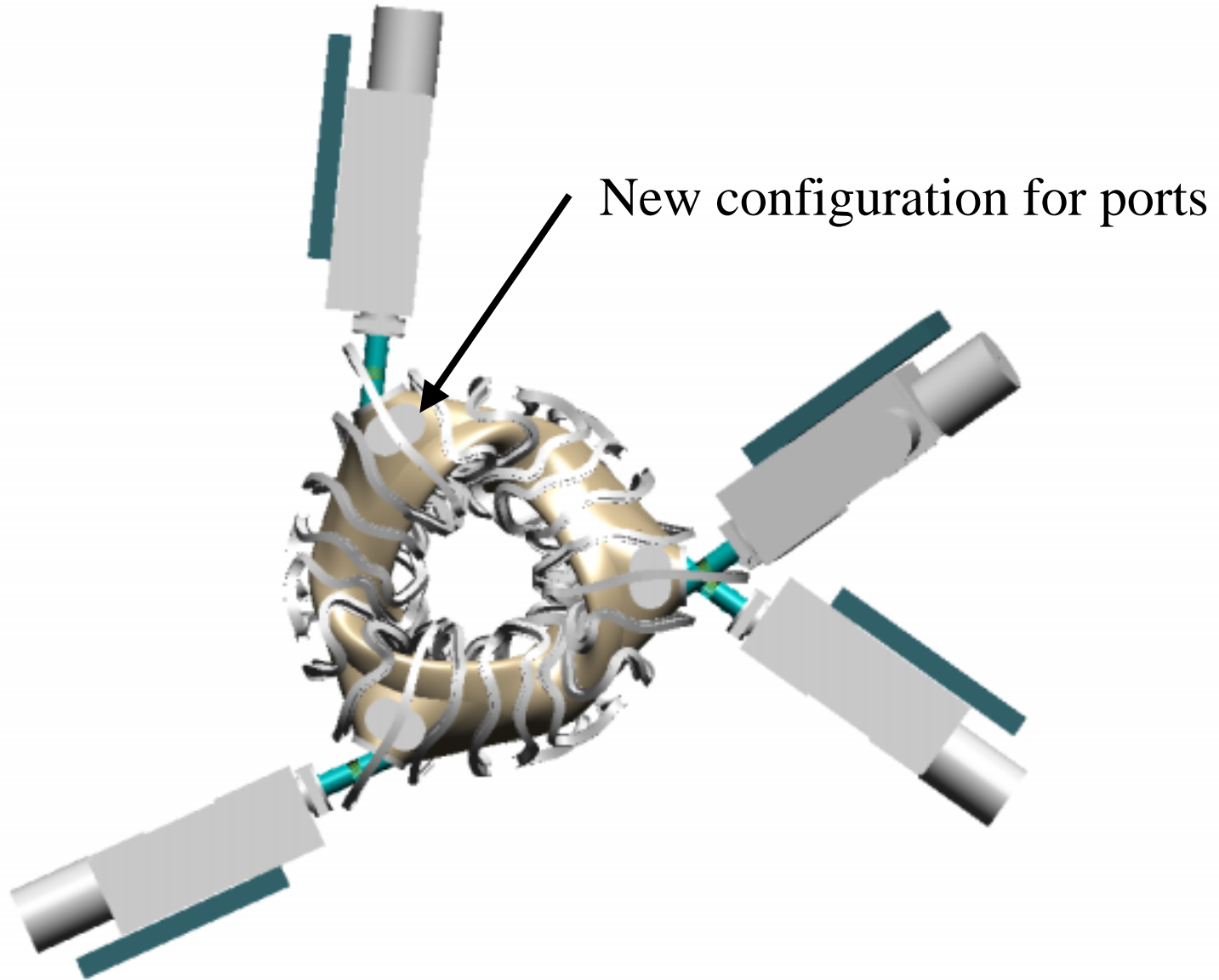

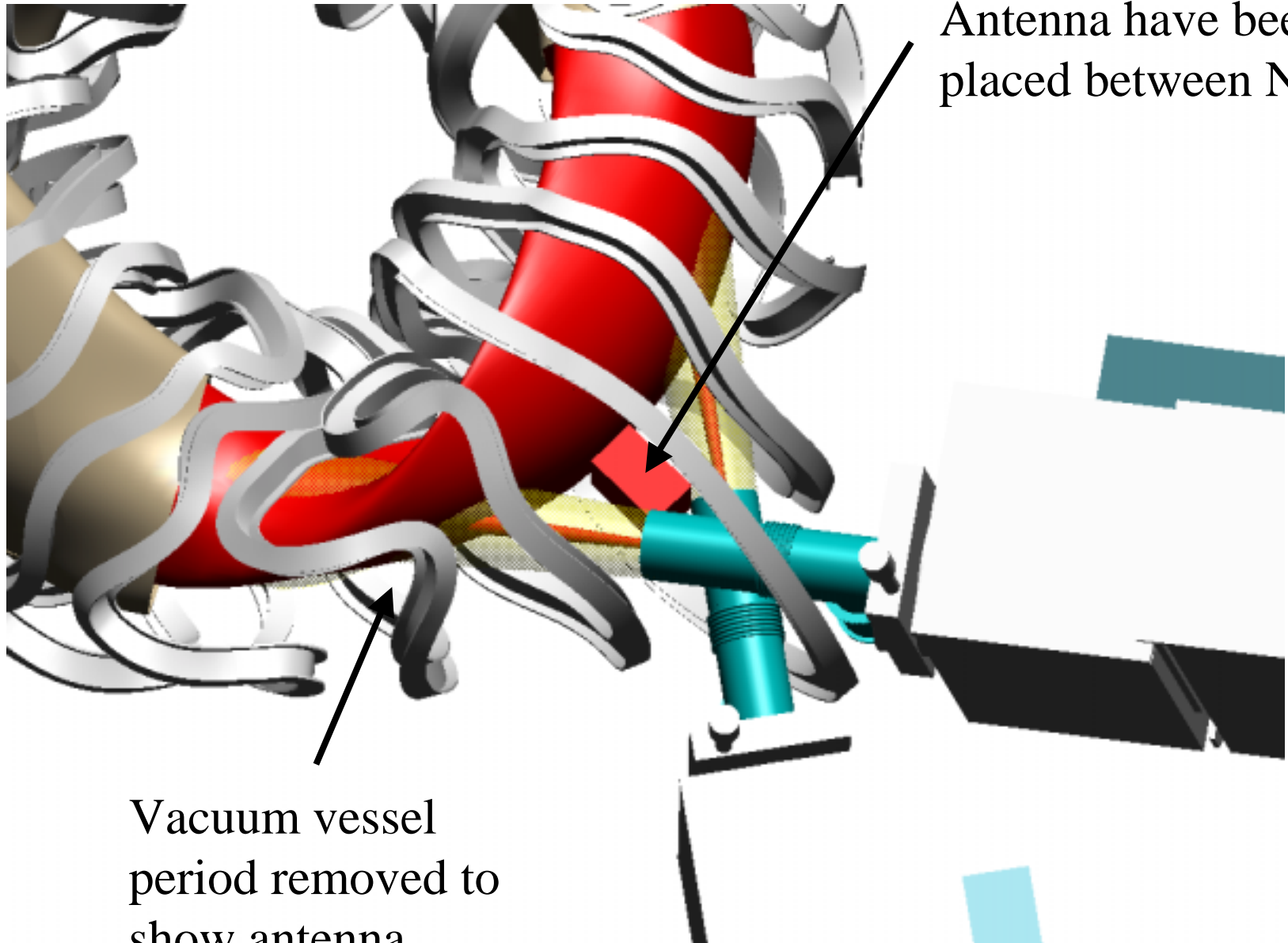

Antenna have been placed between NB

Vacuum vessel period removed to show antenna

NB access appears to be adequate

Additional antenna locations

Antenna can not fit in this location because of the modular coil (see next slide)

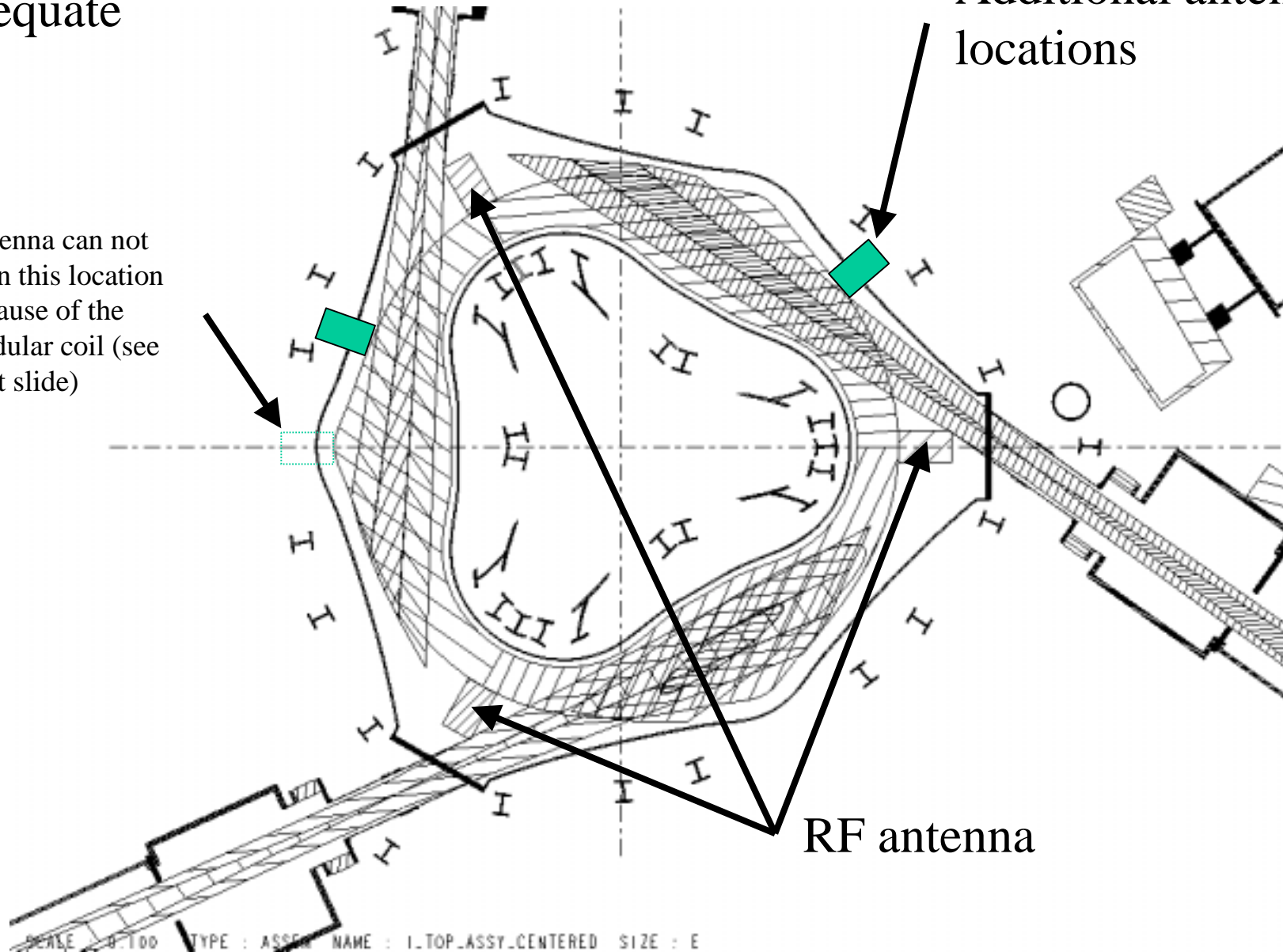

RF antenna

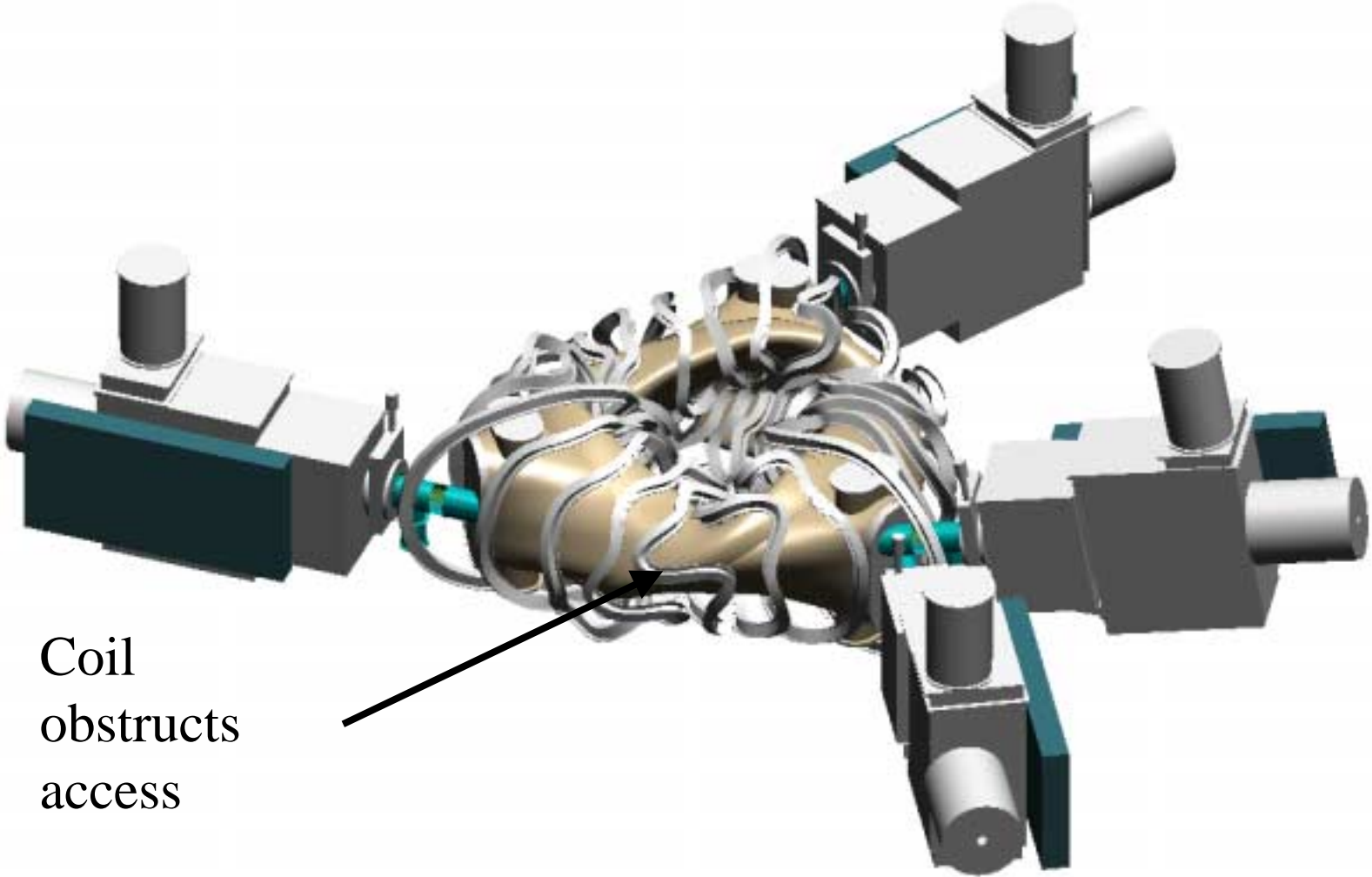

Coil  
obstructs  
access



Possible antenna location

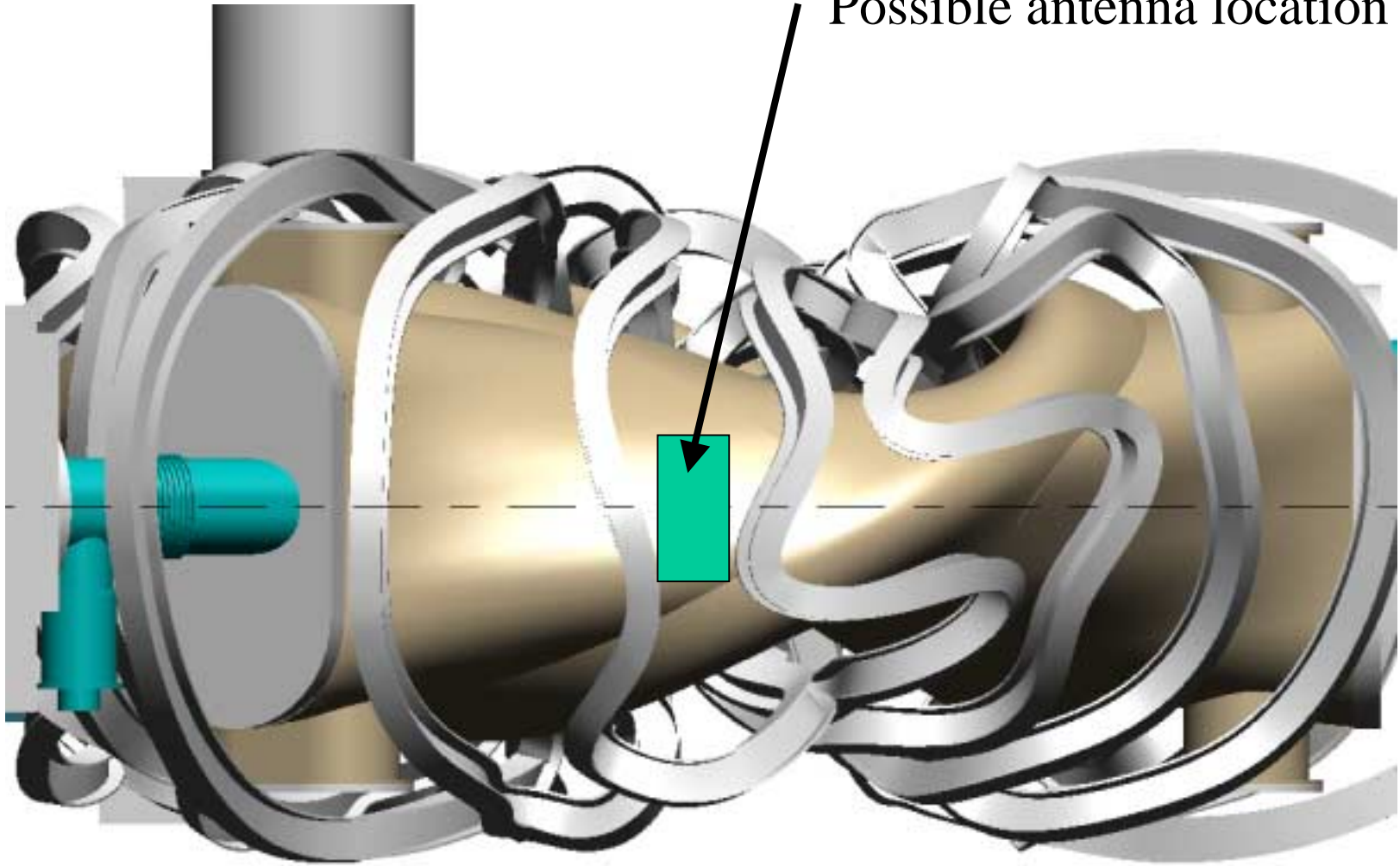

Space available at the midplane for antenna

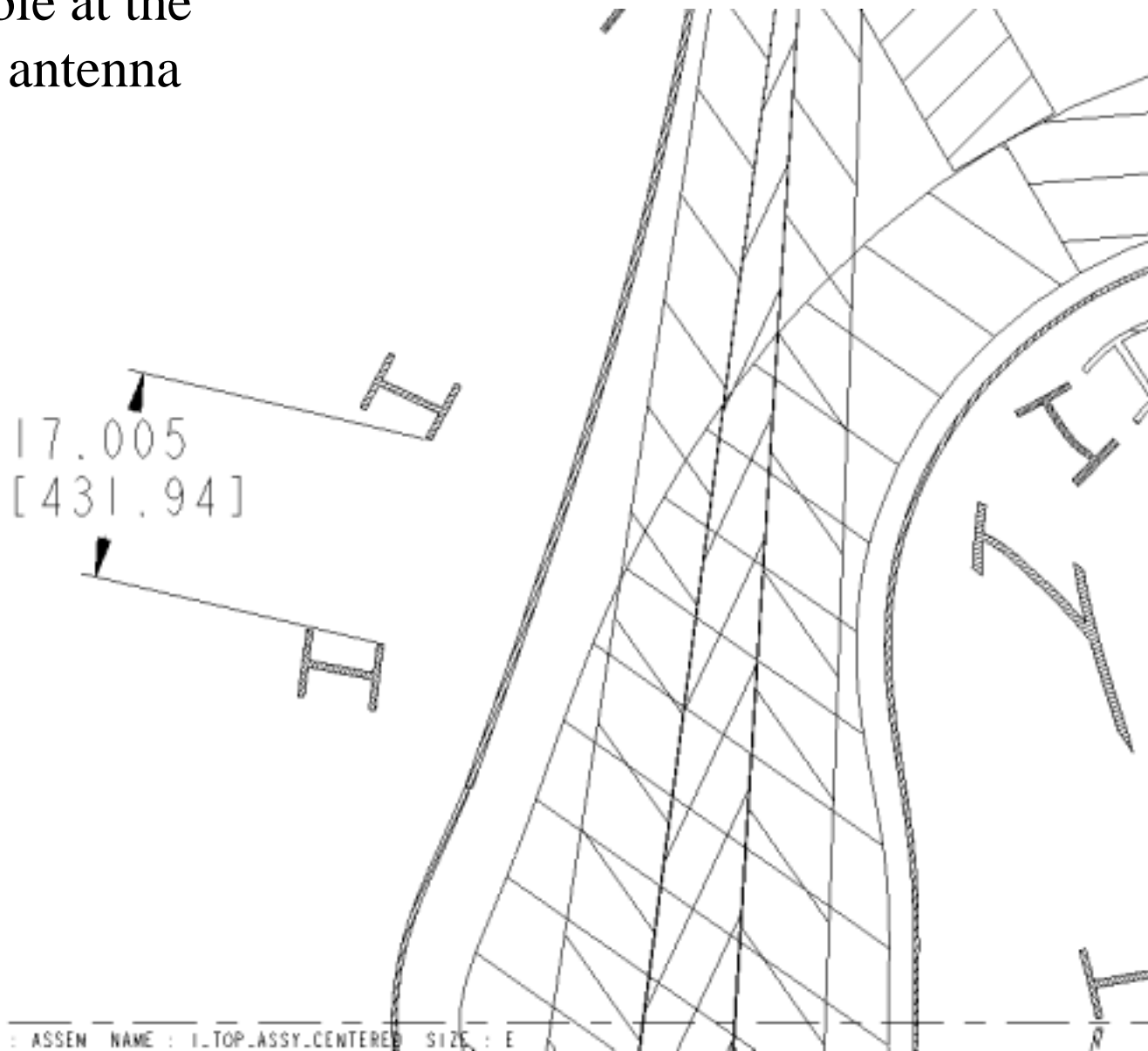

# Antenna dimensions

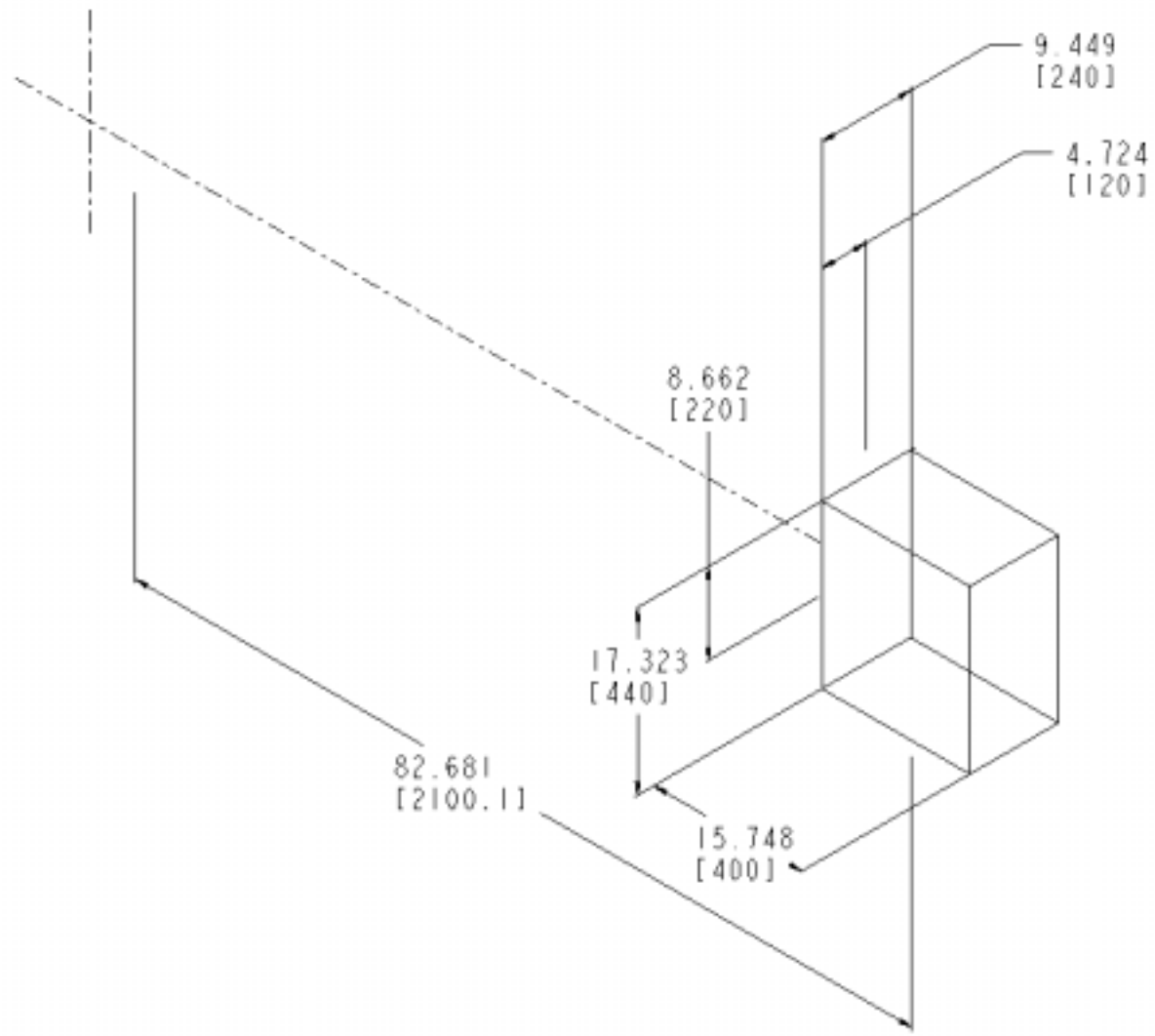

SCALE : 0.375 TYPE : PART NAME : PRT0008 SIZE : E



# 2 co 2 counter centered

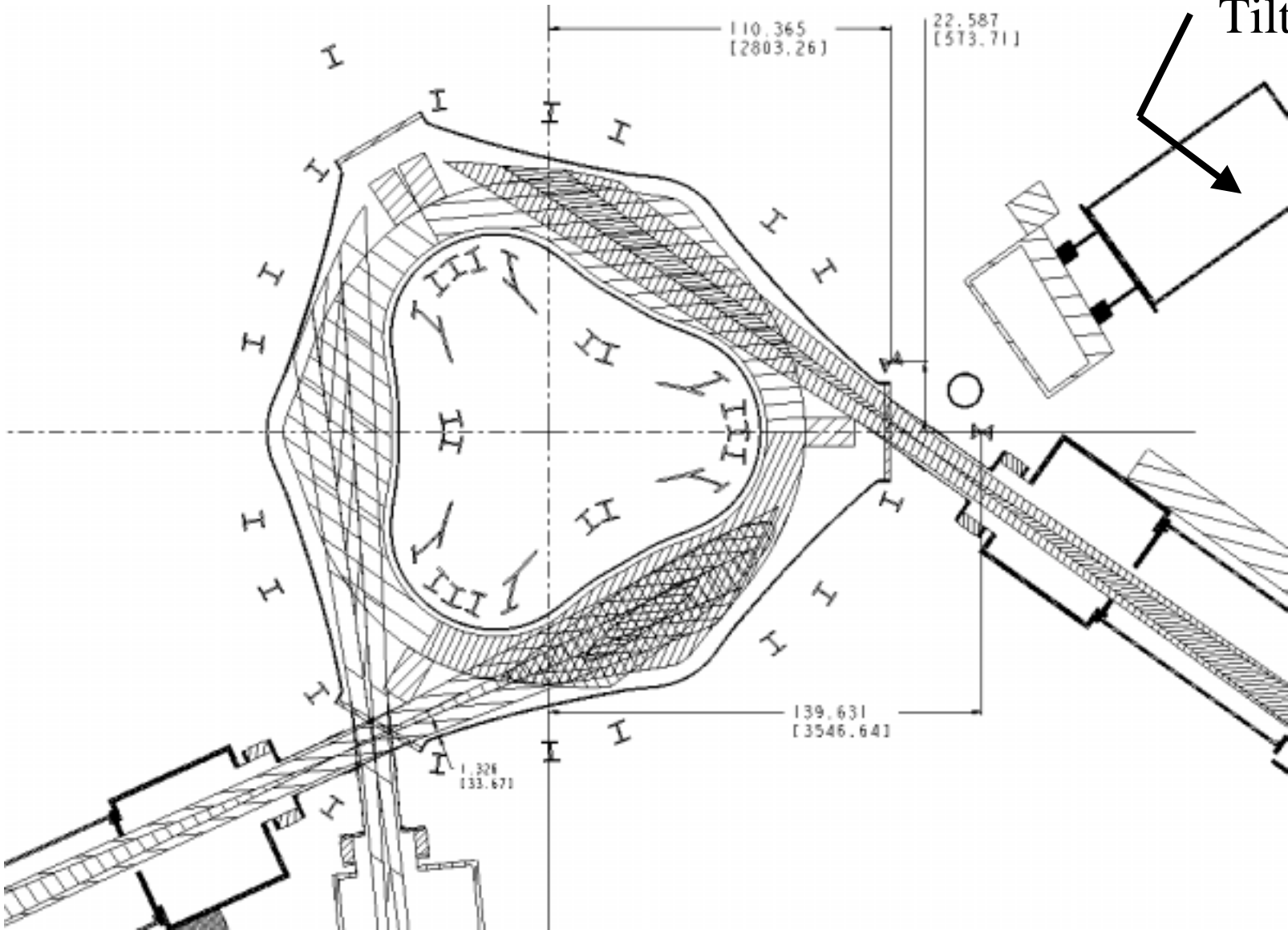

2 co 2 counter centered

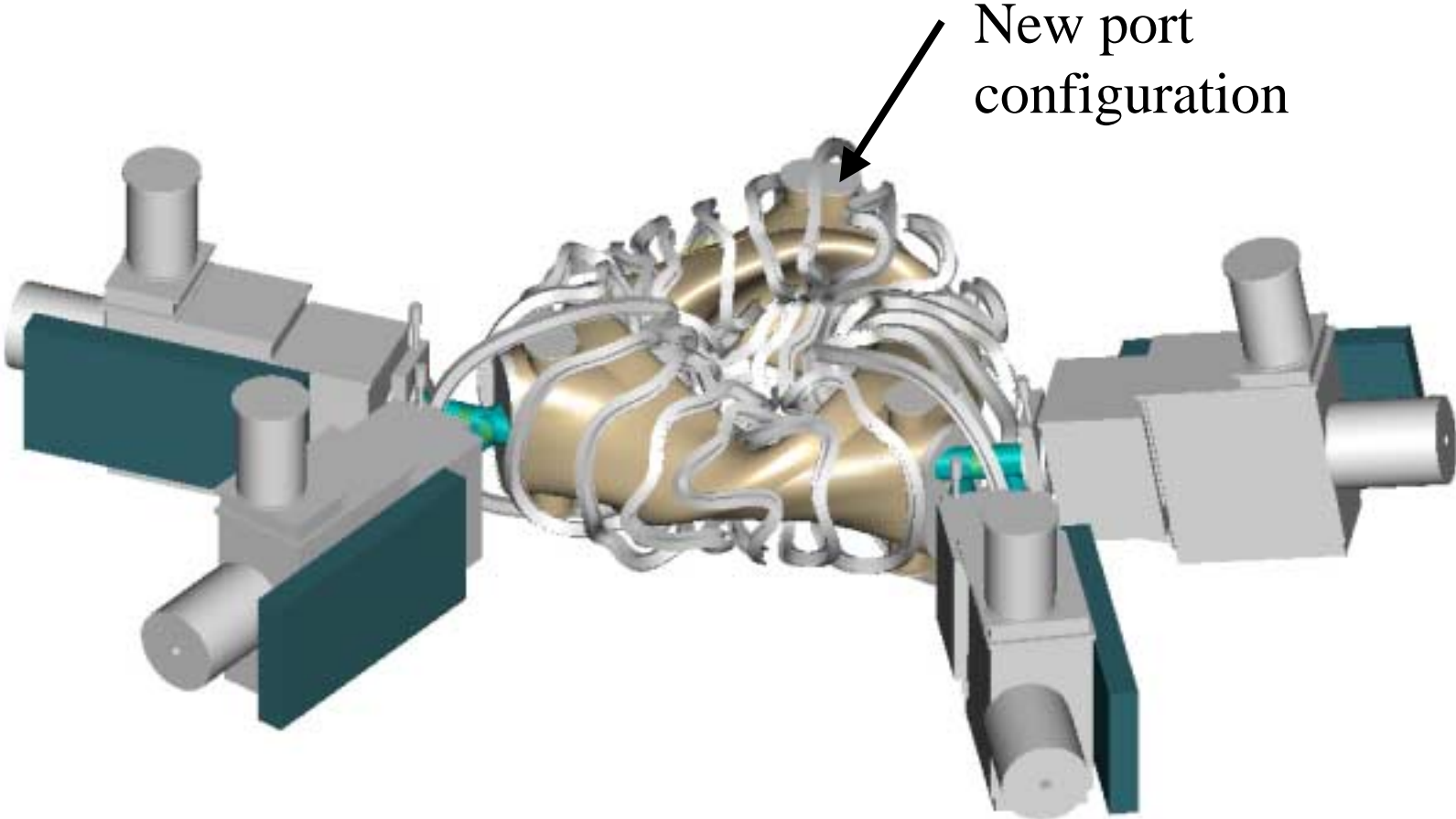

2 ports top and bottom

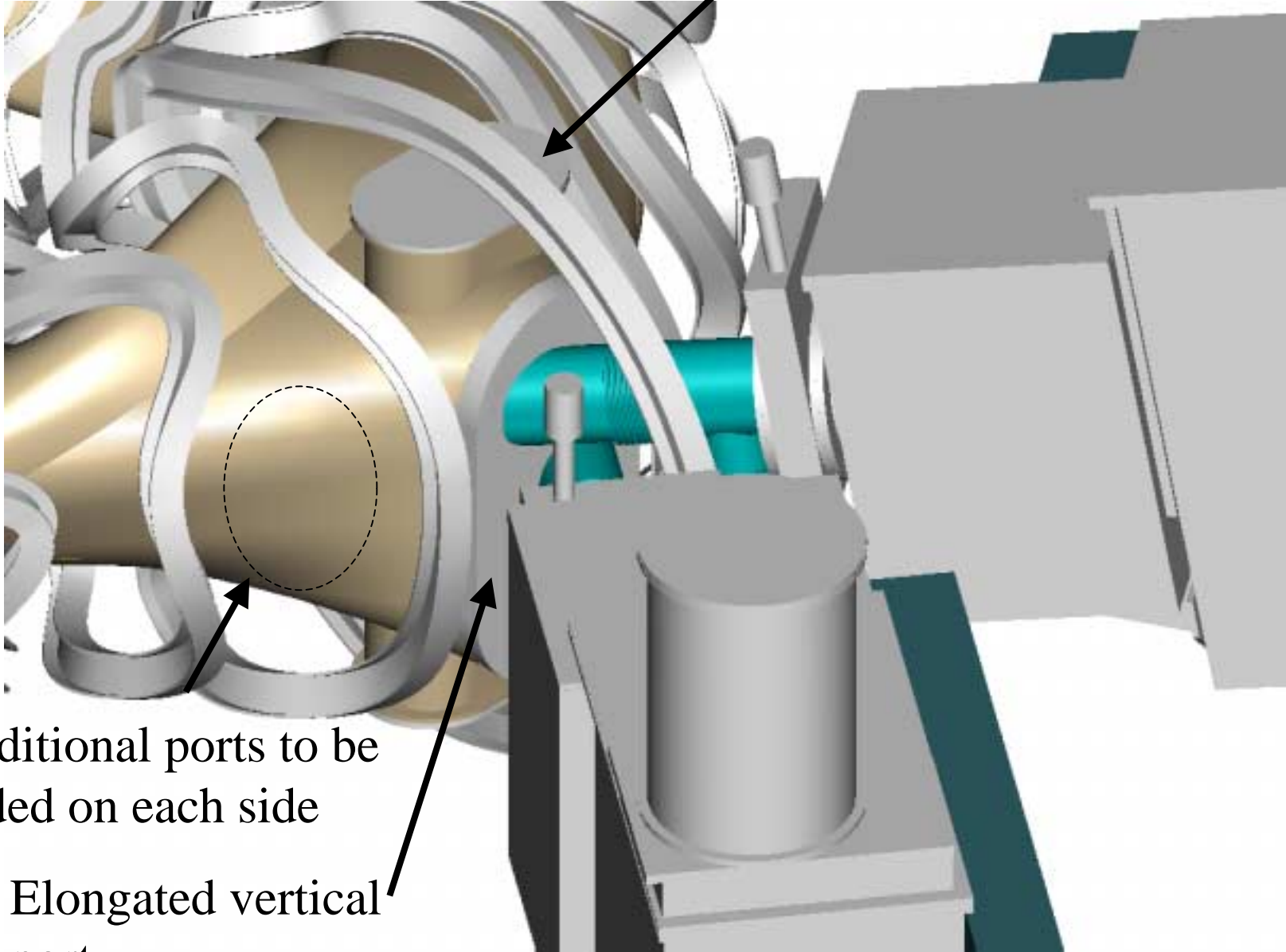

Additional ports to be added on each side

Elongated vertical port

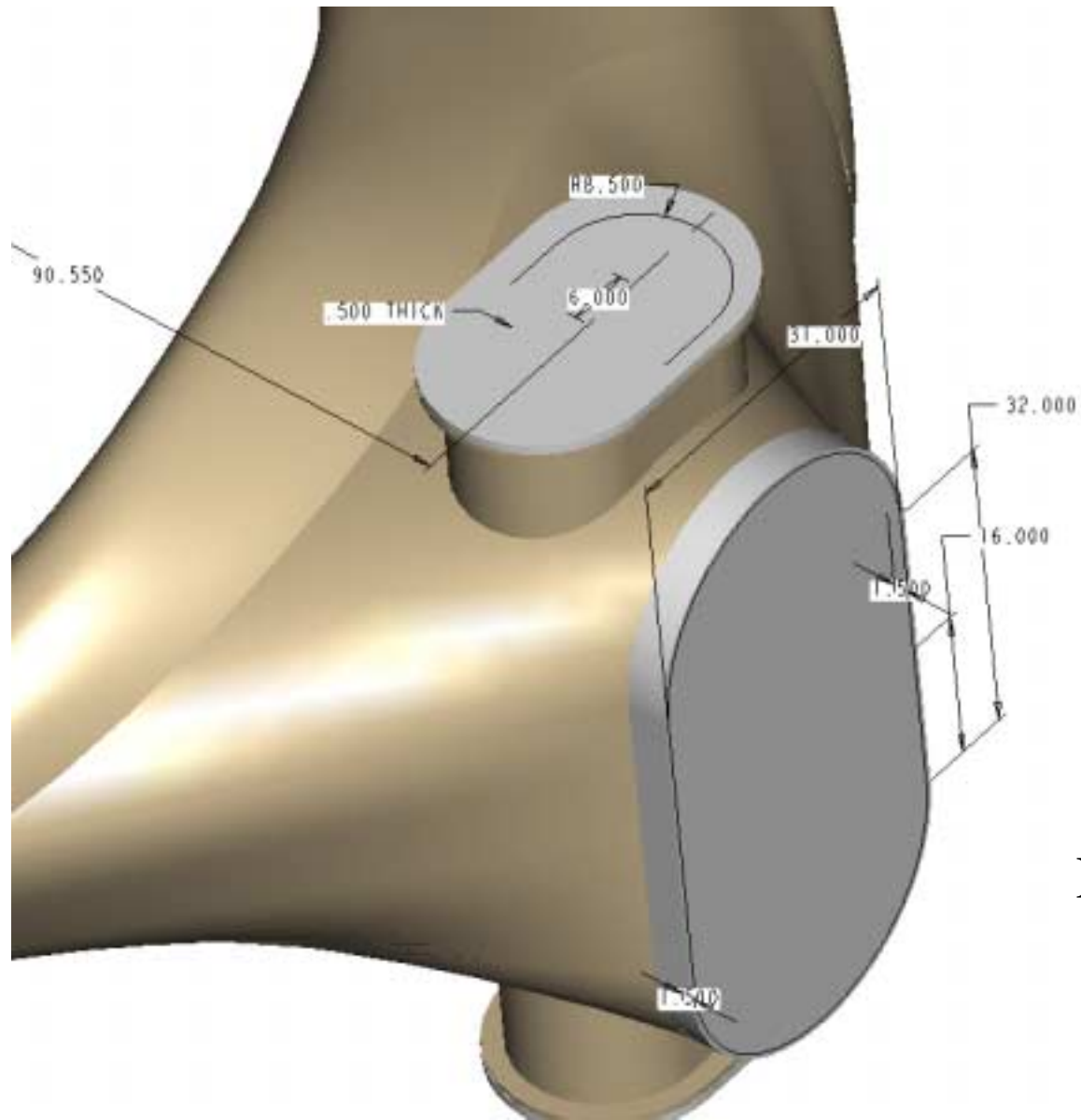

Port Dimensions

2 co 2 counter

NB access  
appears to be  
adequate

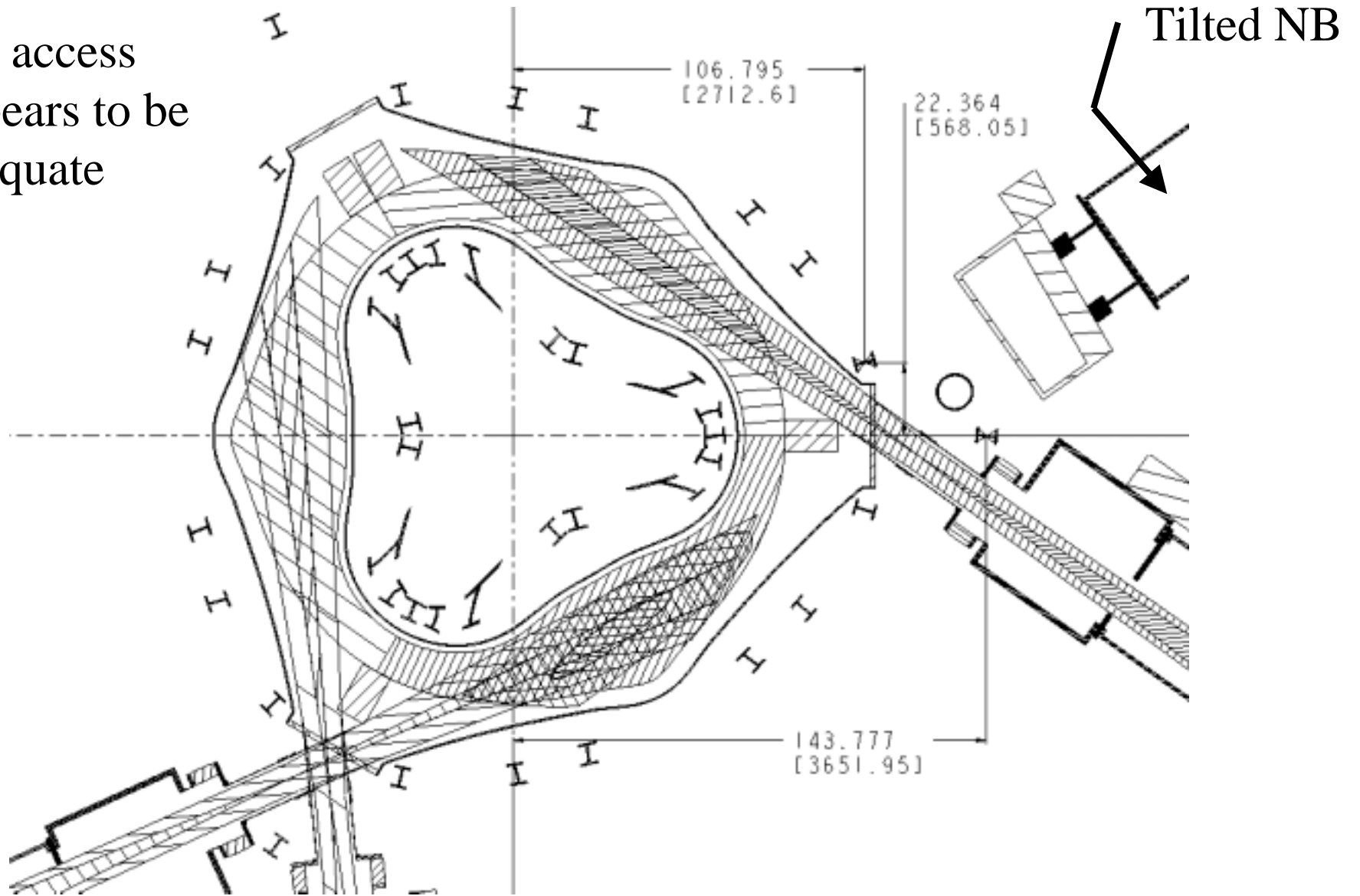

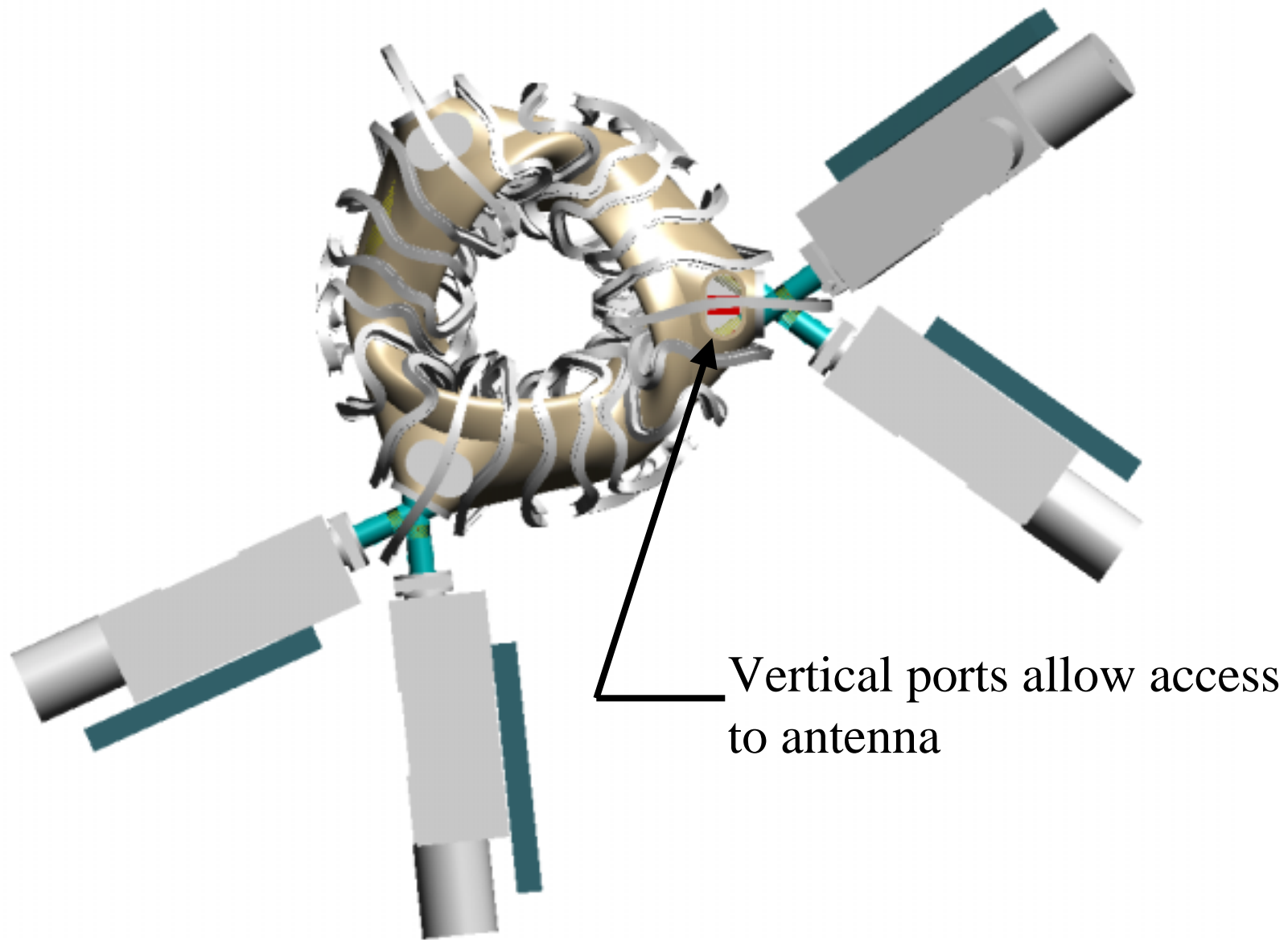

Vertical ports allow access  
to antenna

# RF antenna access

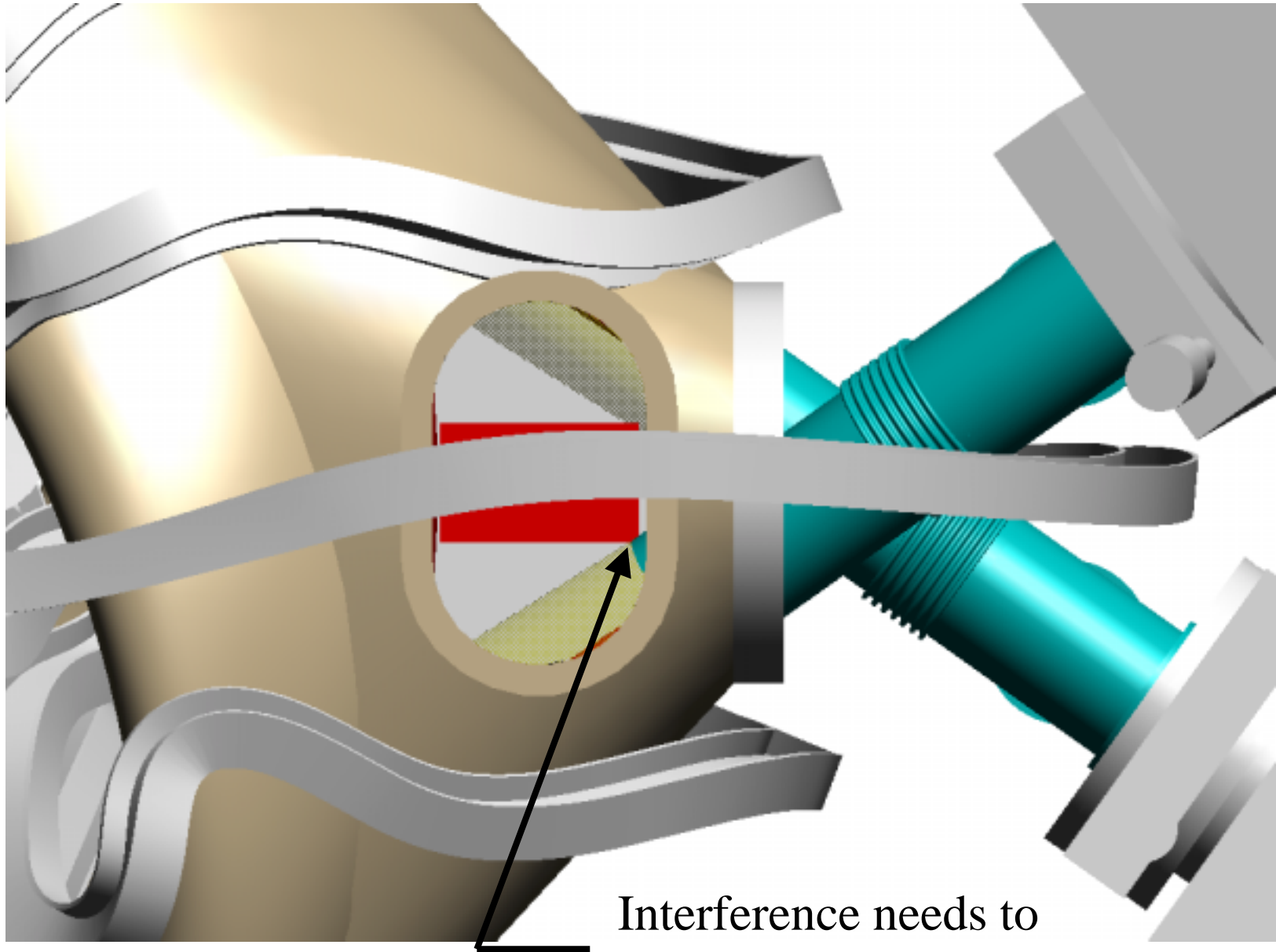

Interference needs to be investigated

# RF antenna access

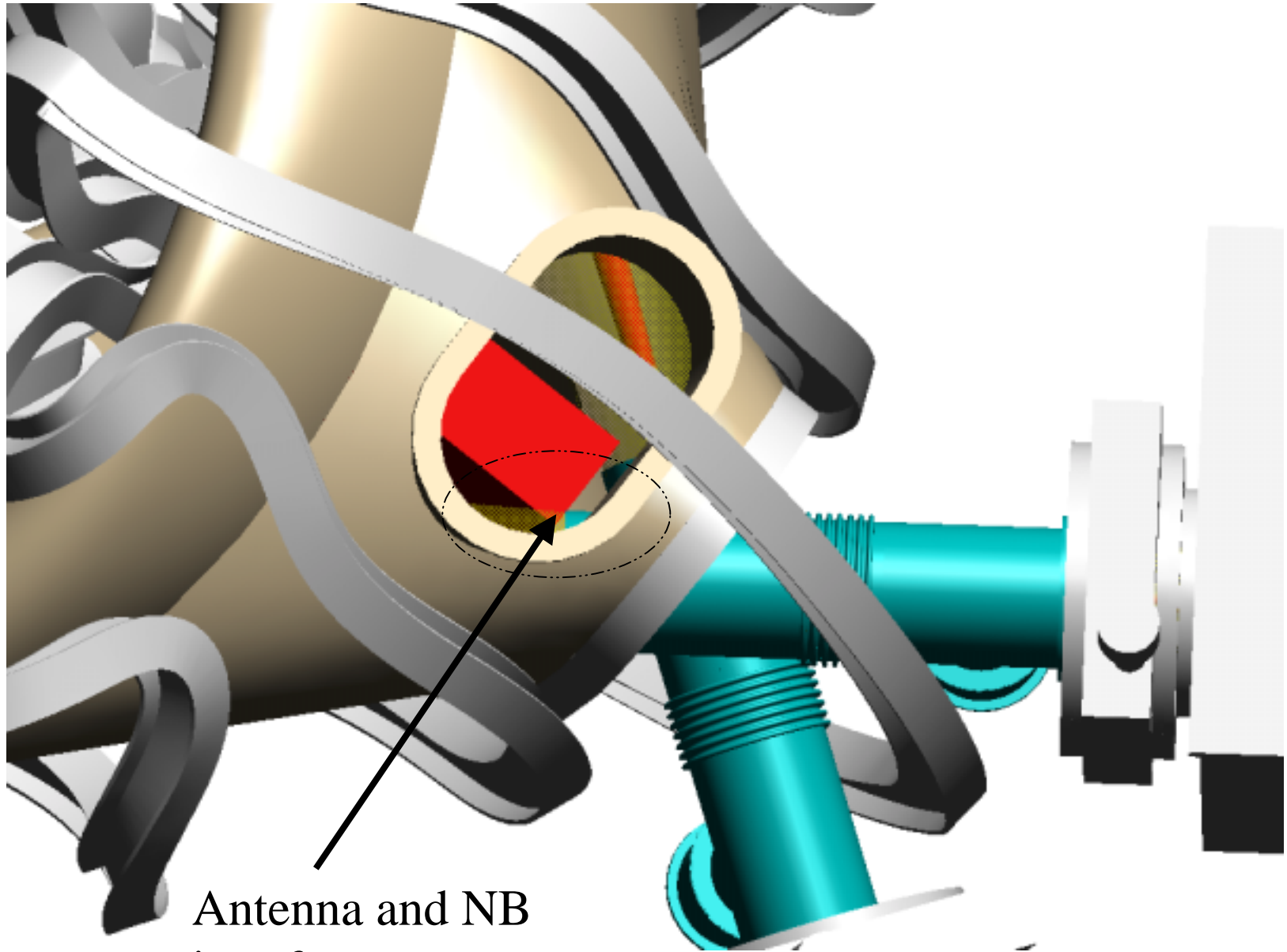

Antenna and NB  
interference