

COIL TO COIL INTERFACE A-A

WING TOL= $-.12 / -.25$

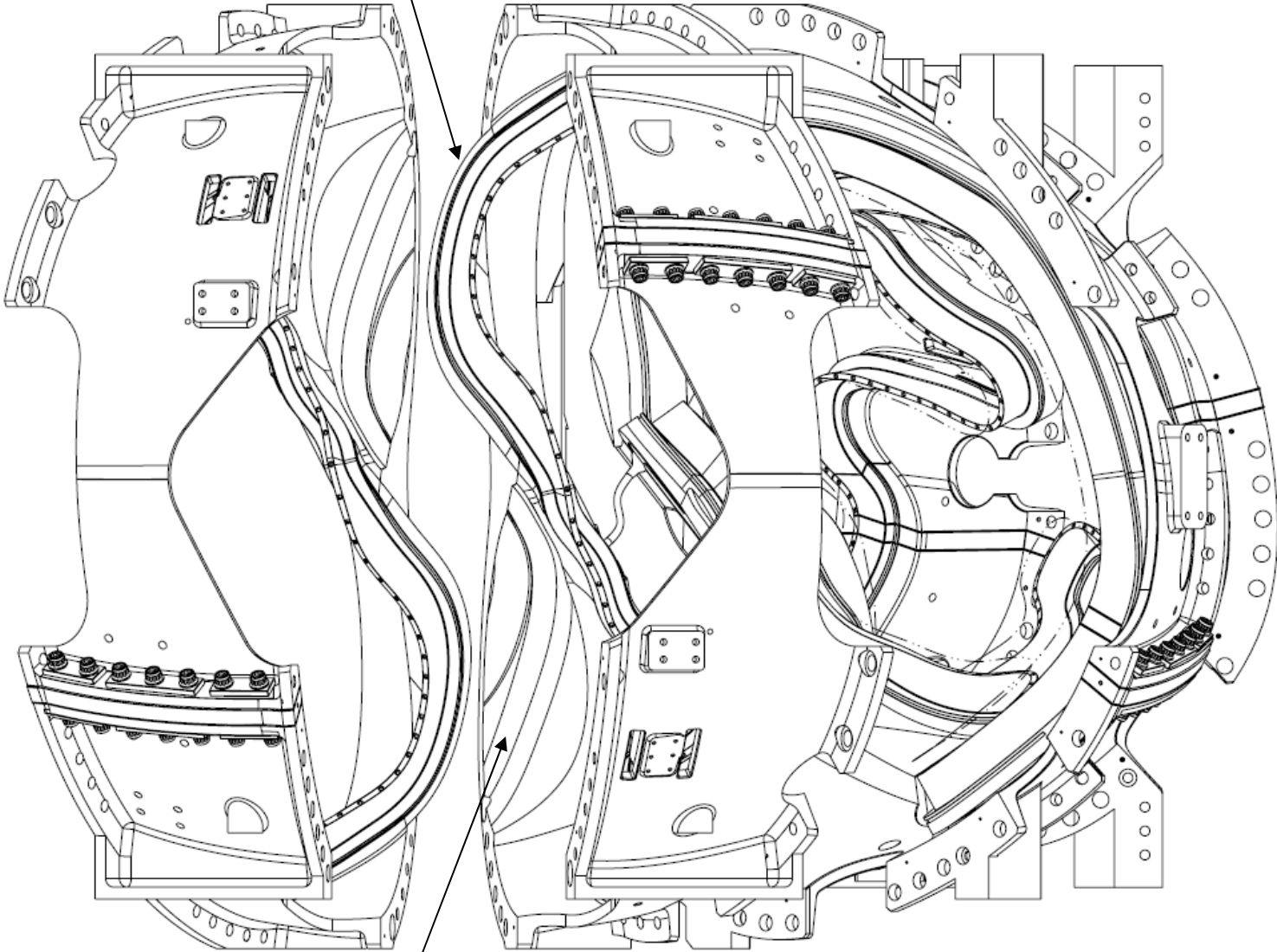

POCKET TOL= $\pm .25$

COIL TO COIL INTERFACE A-A

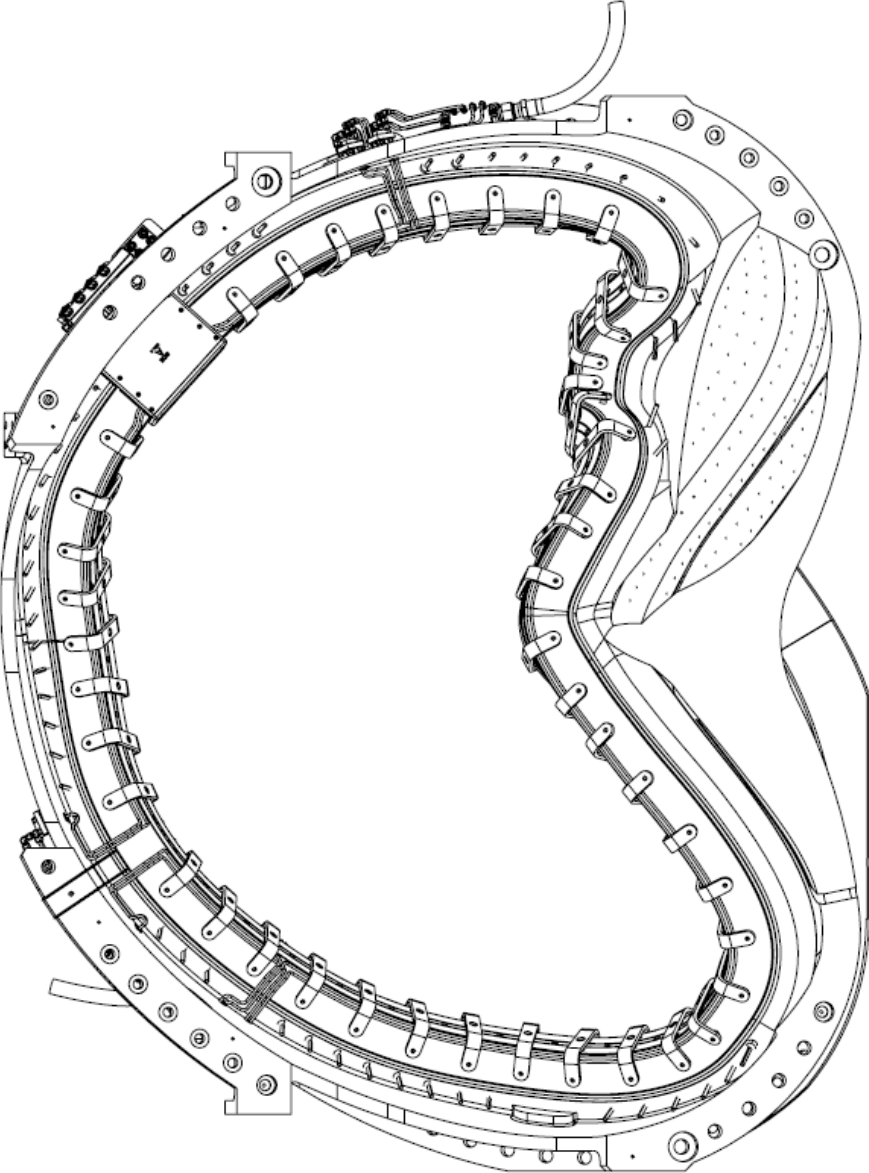

TYPE-A SIDE-A
(FLANGE DATUM-D)

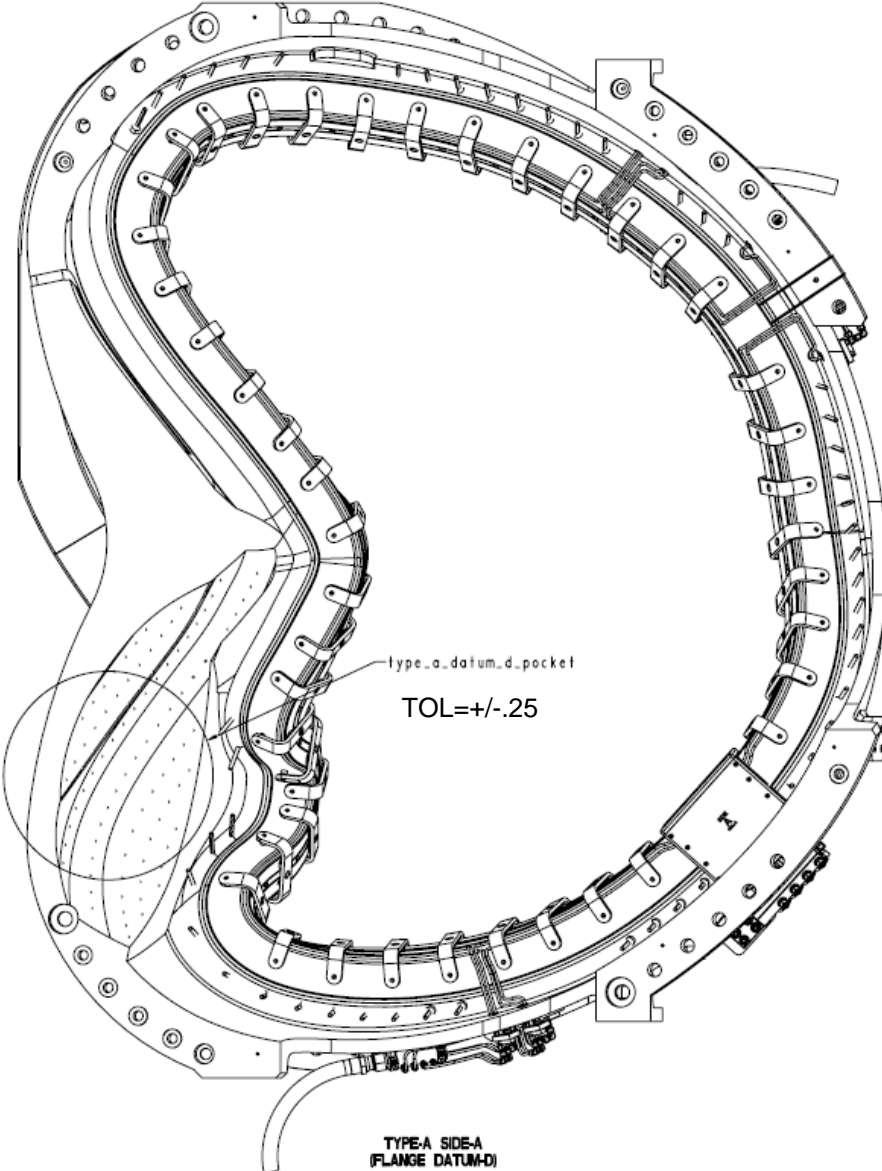

TYPE-A SIDE-A
(FLANGE DATUM-D)

TYPE-A, SIDE-A COMPARED TO SCANS A3-A6

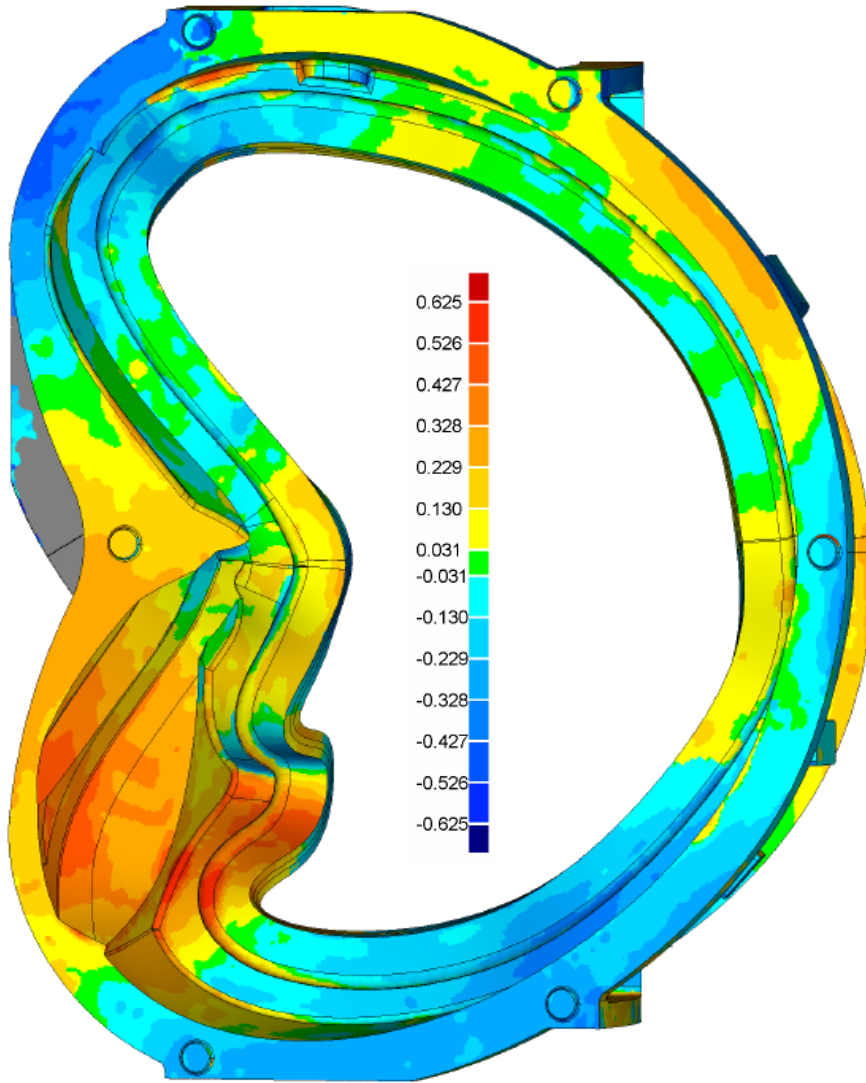

MCWF-A4

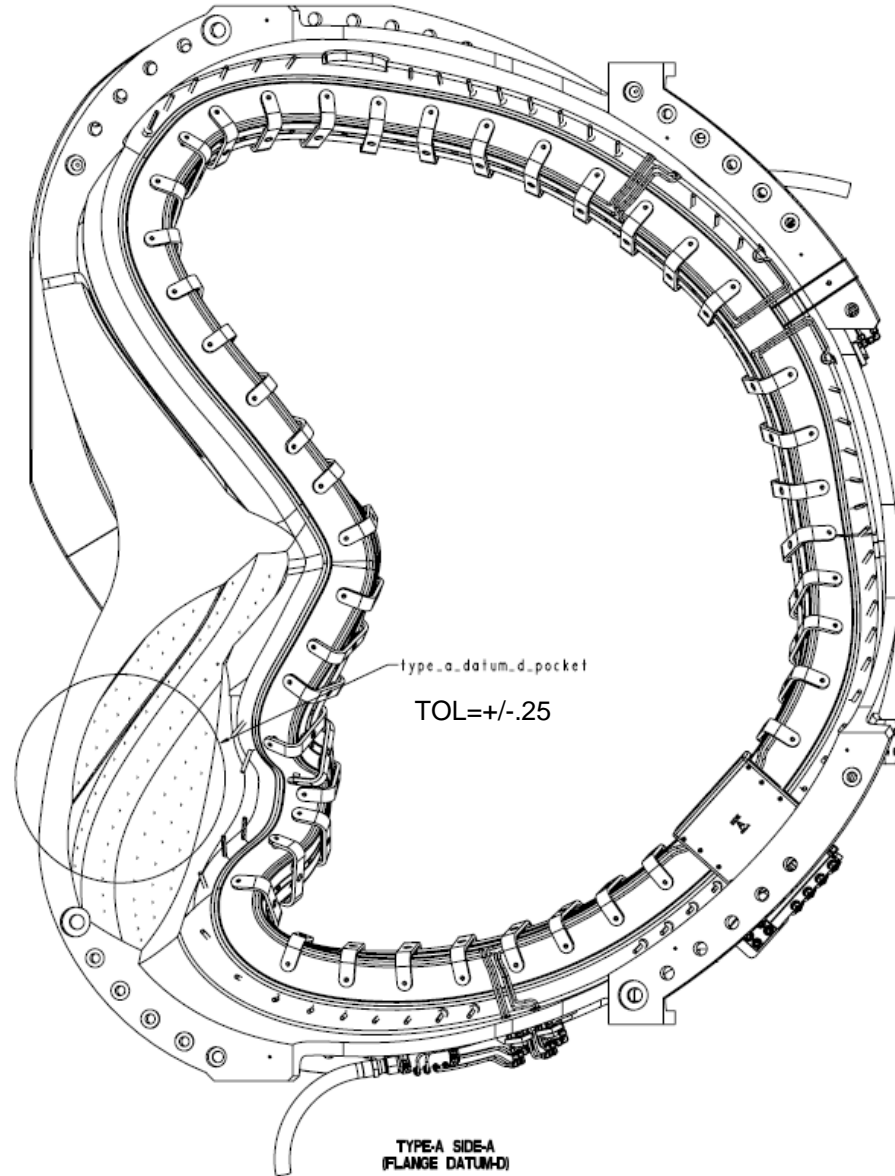

TYPE A SIDE-A
(FLANGE DATUM-D)

TYPE-A, SIDE-A COMPARED TO A1 FINAL DIMENSIONS

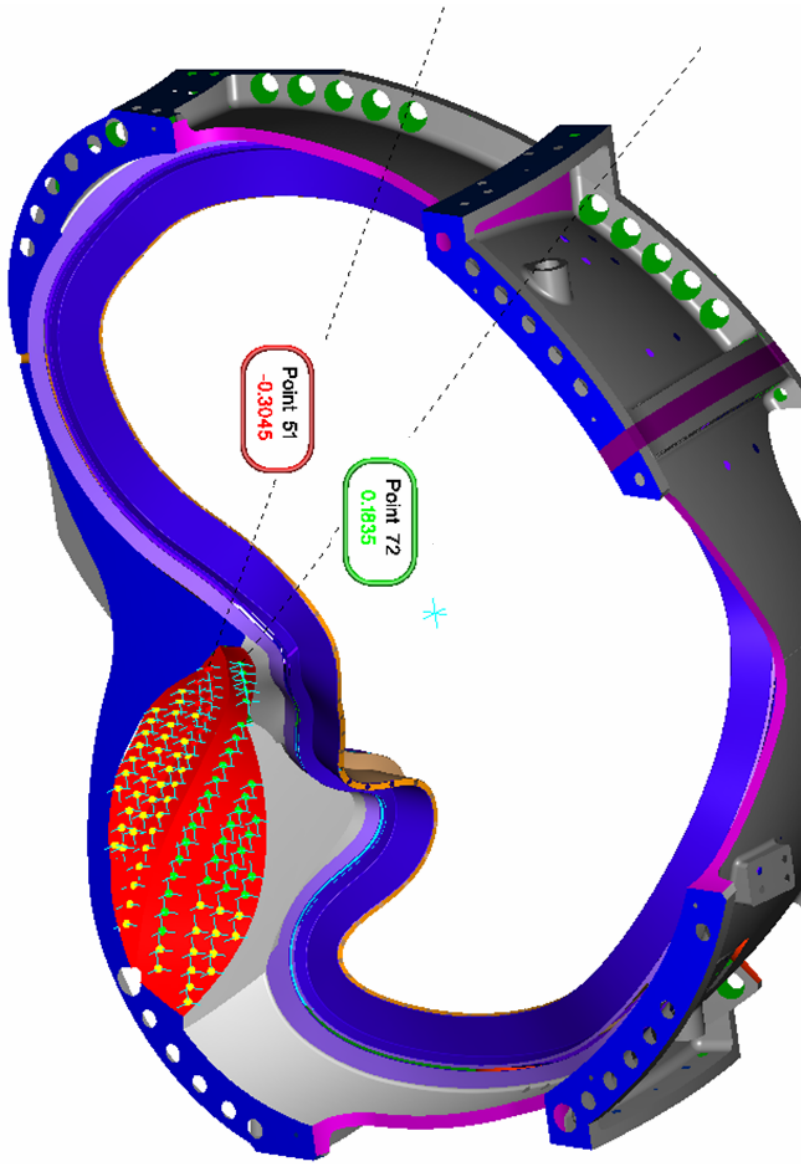

VERISURF DATA- A1

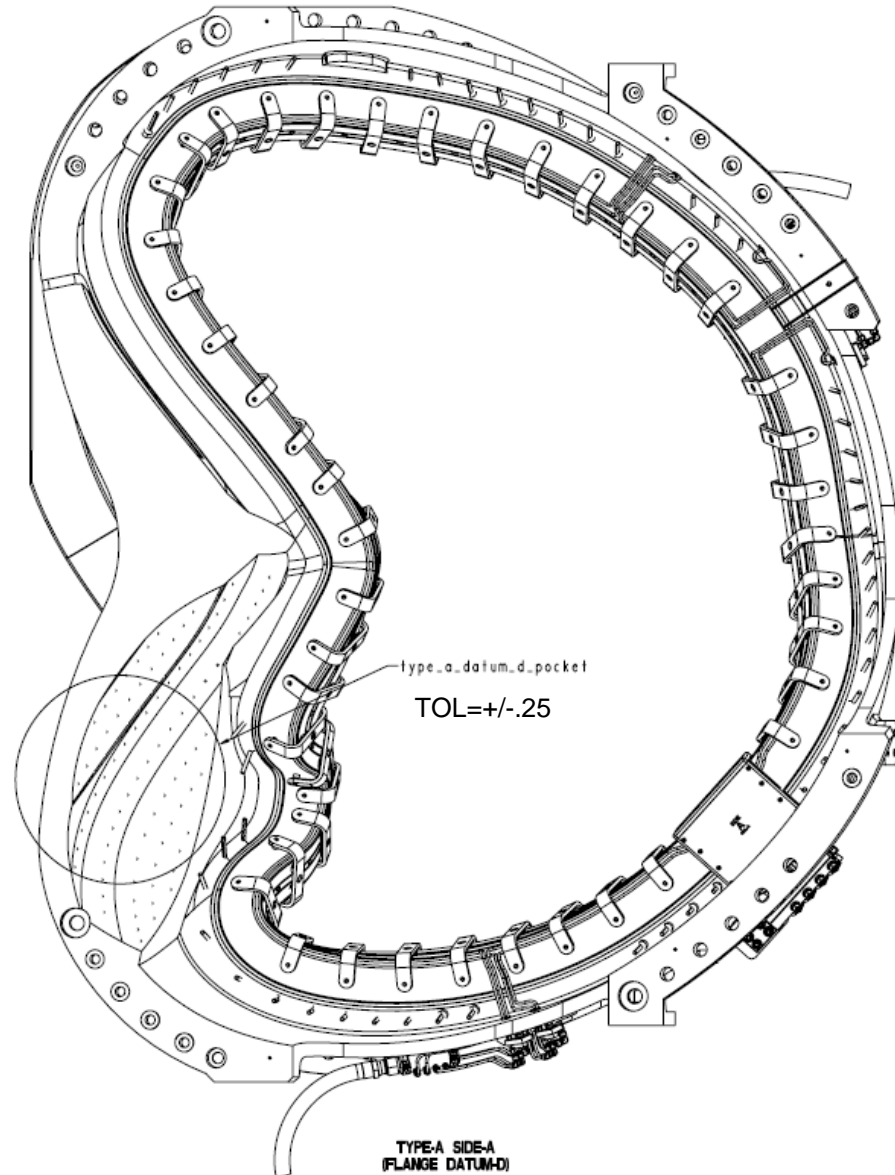

TYPE-A SIDE-A
(FLANGE DATUM-D)

COIL TO COIL INTERFACE A-B

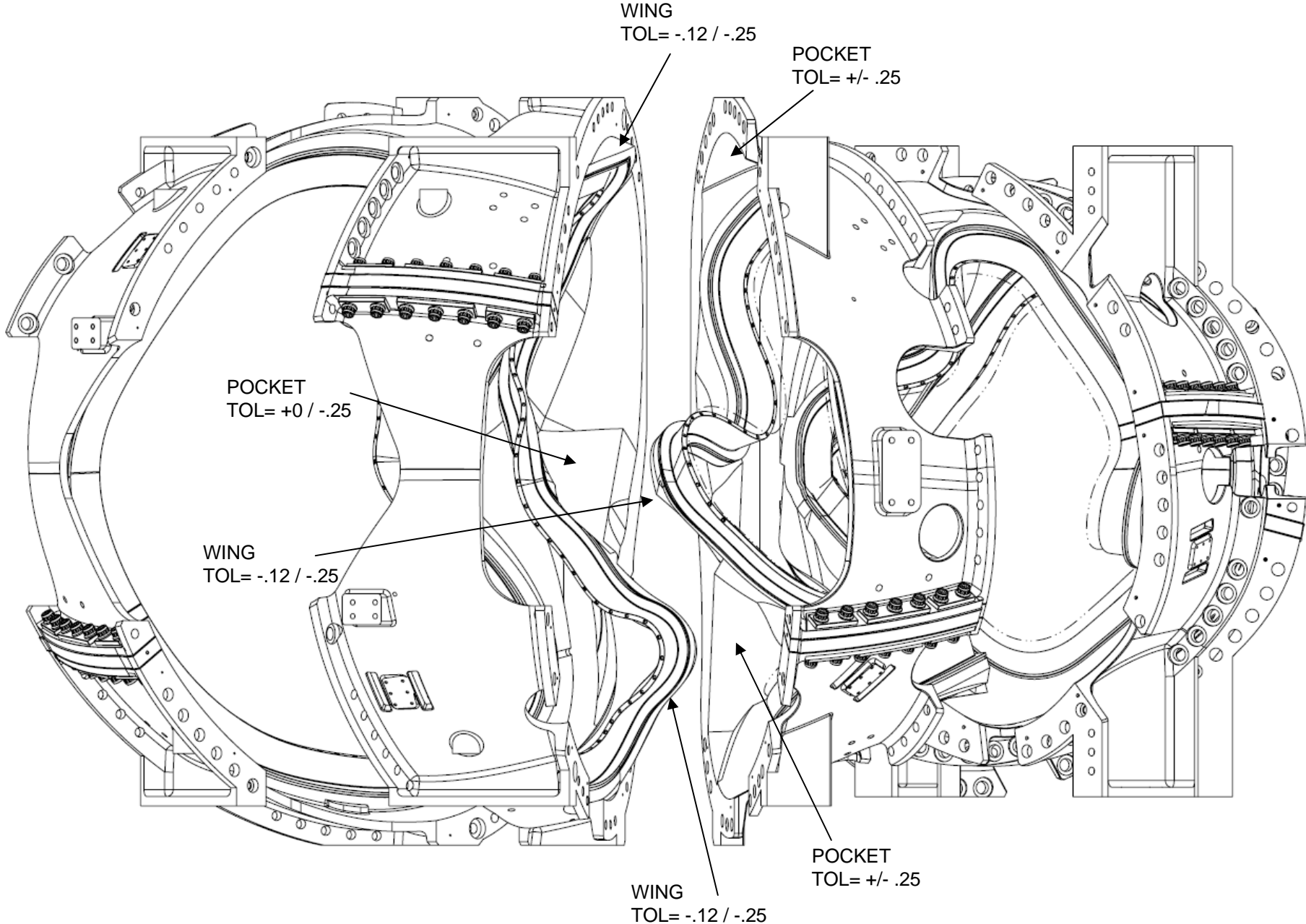

COIL TO COIL INTERFACE A-B

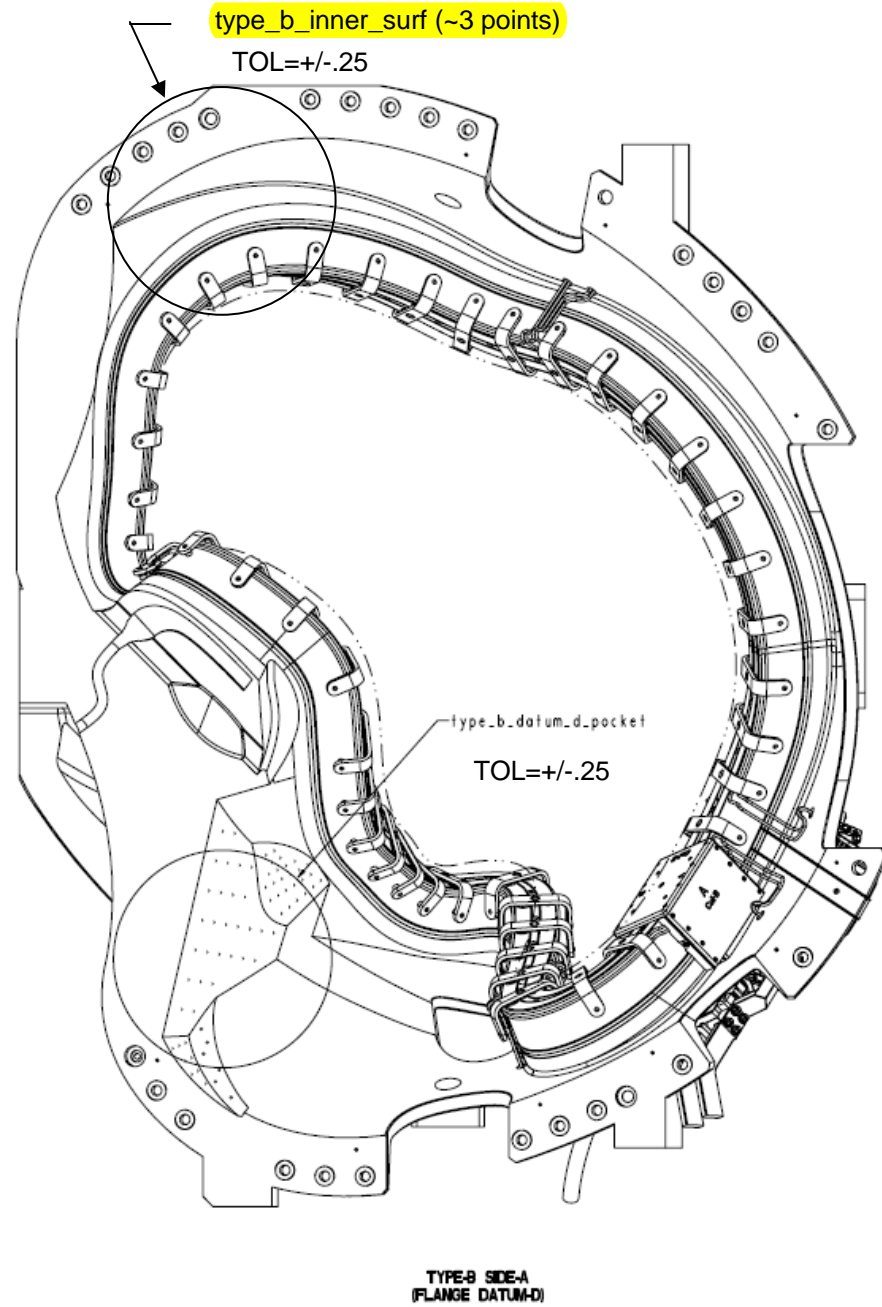
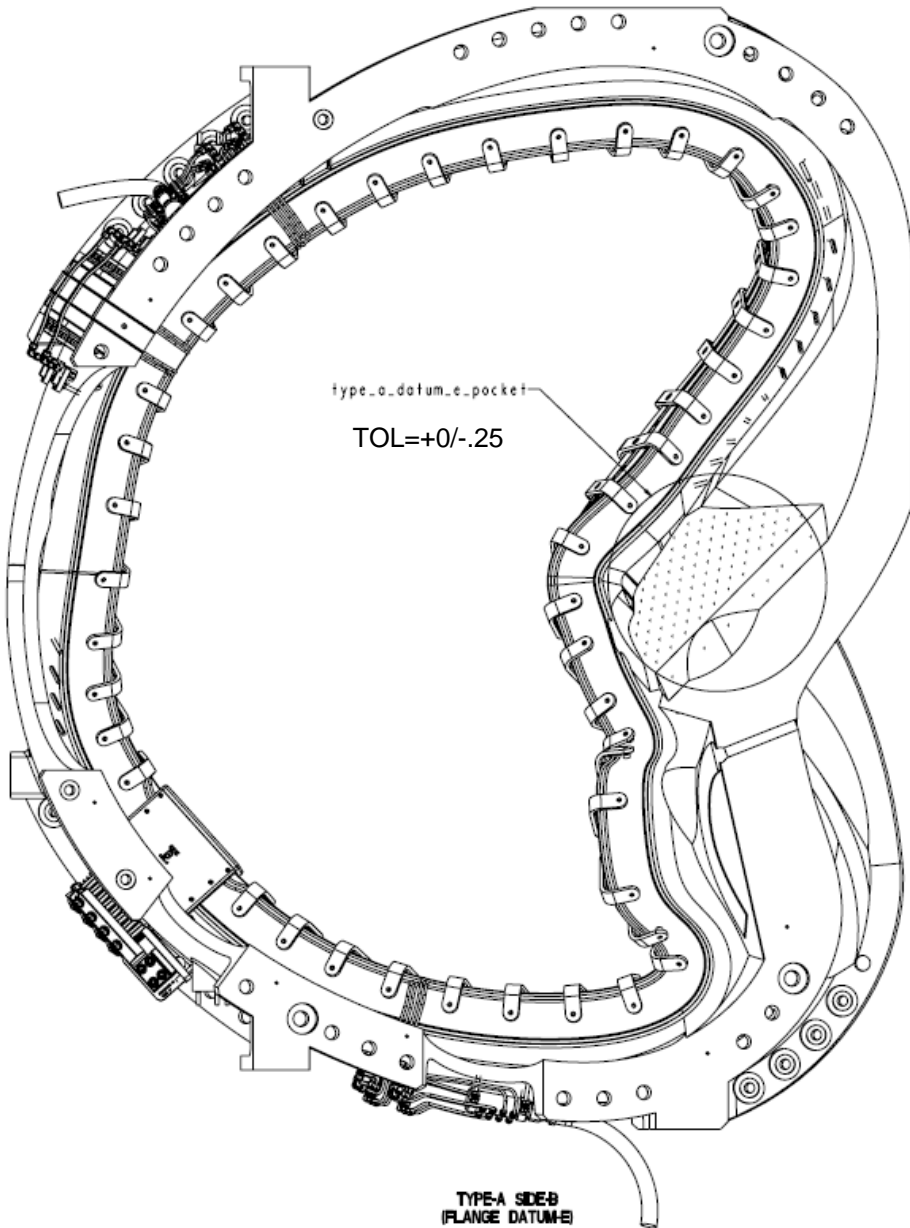

TYPE-A, SIDE-B COMPARED TO SCANS A5, A6

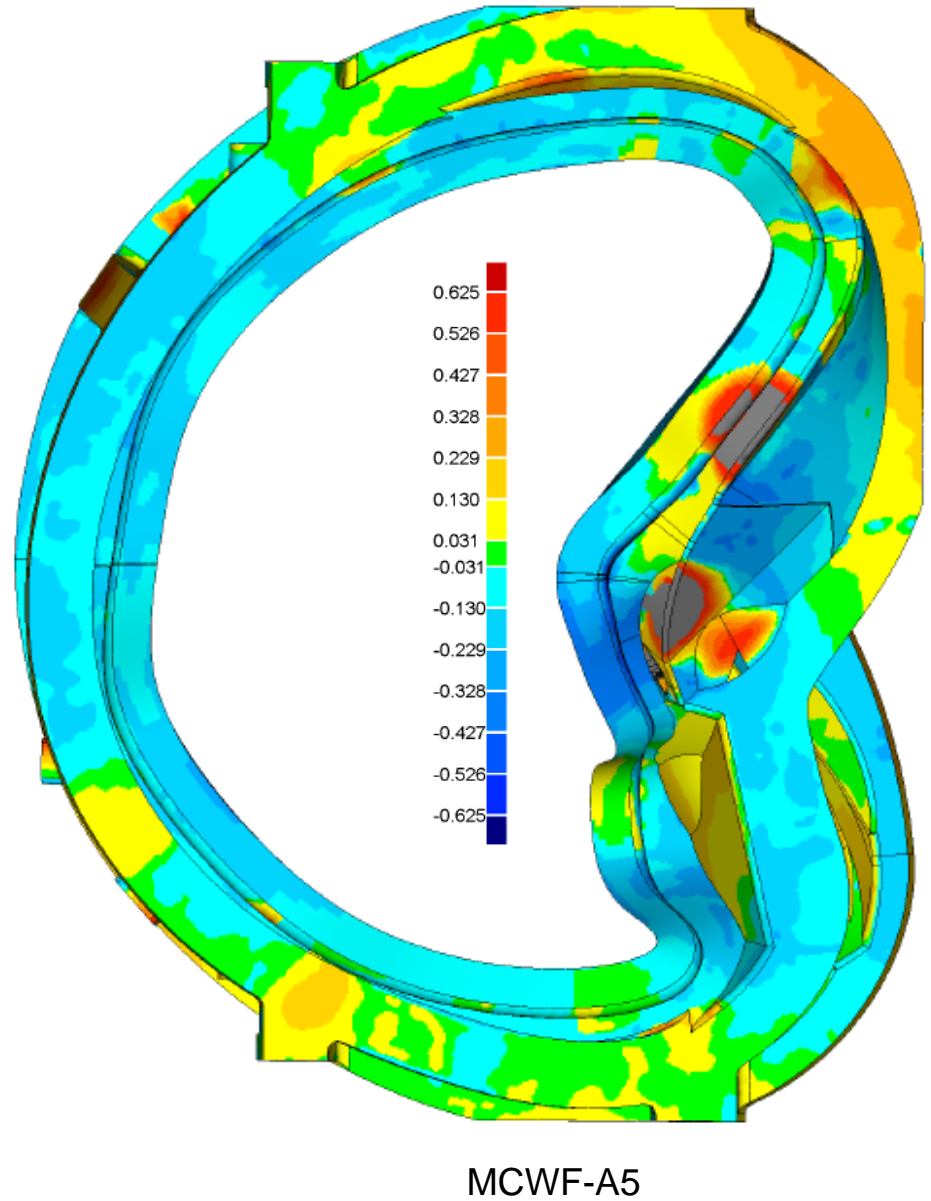
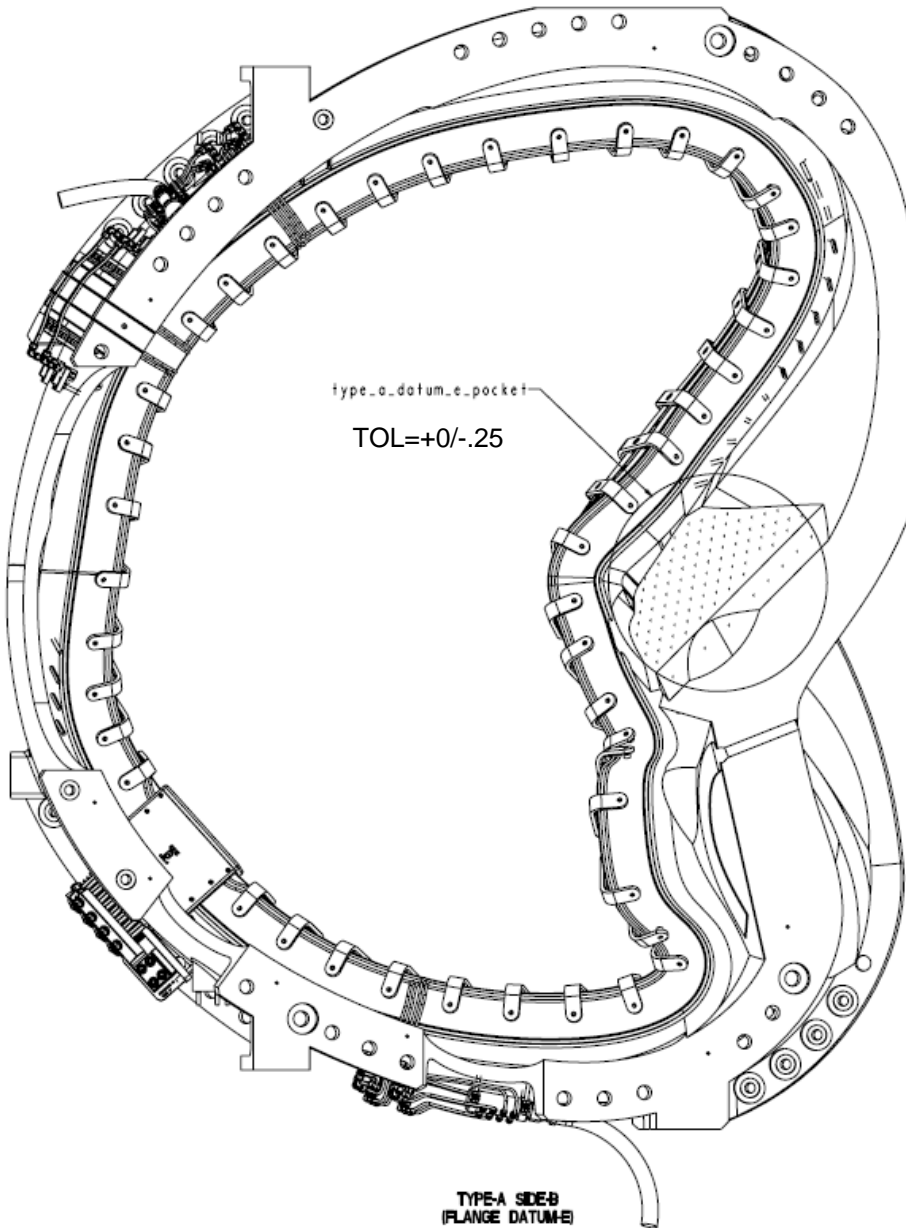

TYPE-A, SIDE-B COMPARED TO A1 FINAL DIMENSIONS

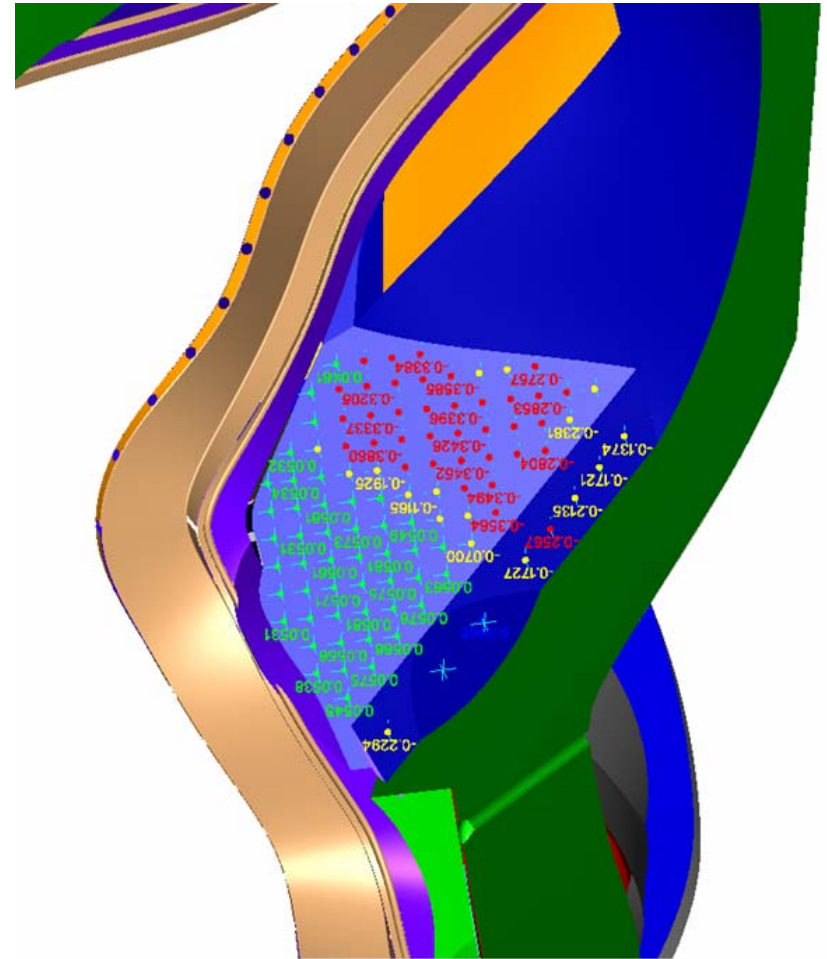
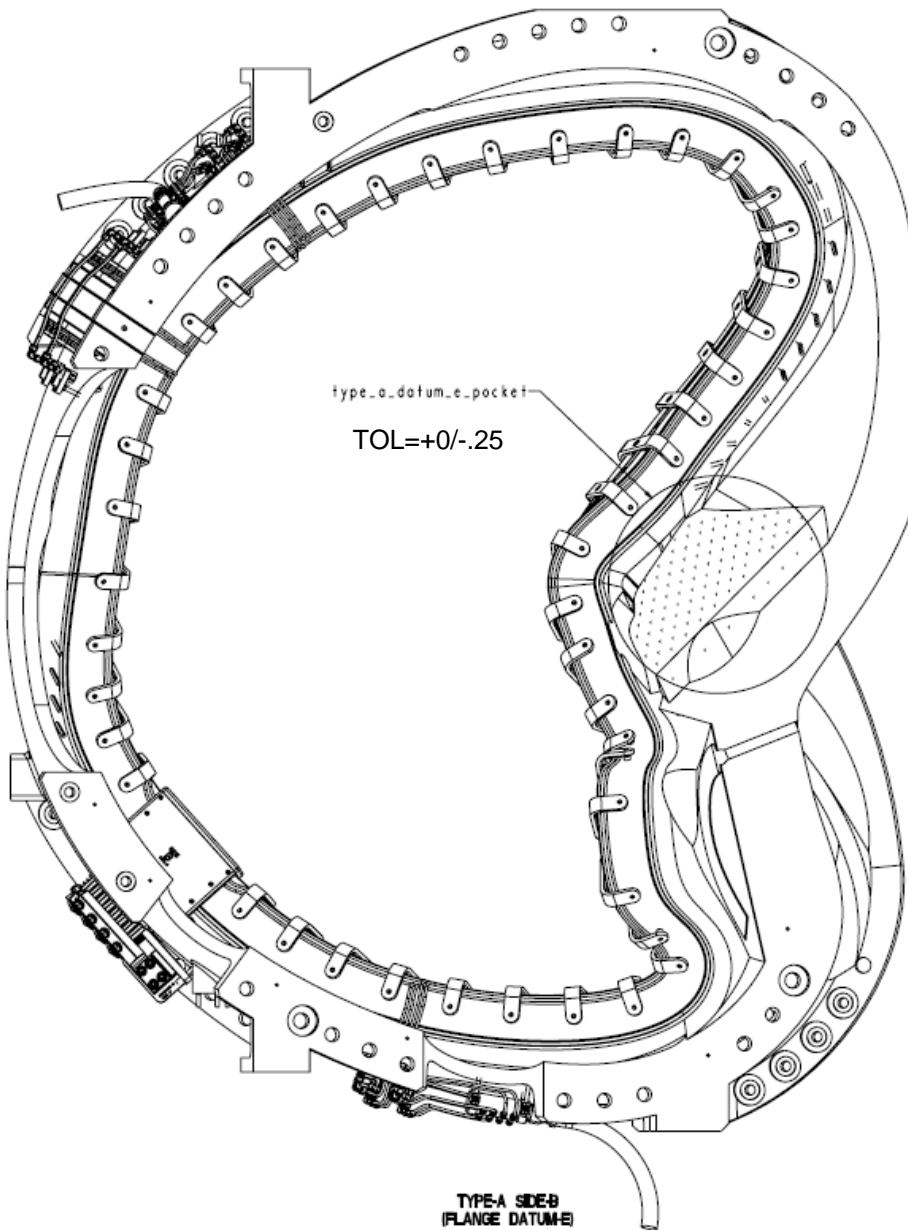

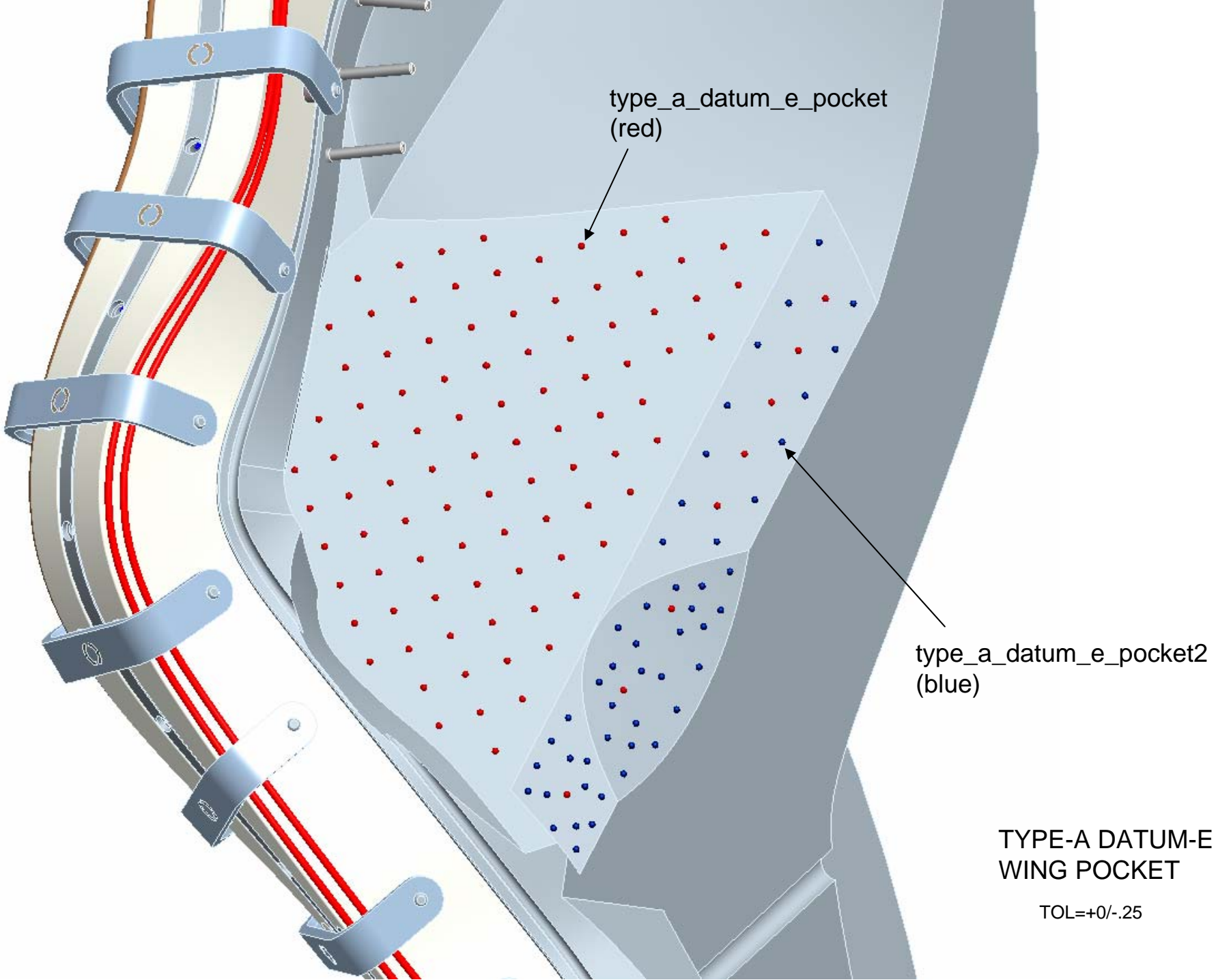

type_a_datum_e_pocket
(red)

type_a_datum_e_pocket2
(blue)

TYPE-A DATUM-E
WING POCKET

TOL=+0/-.25

TYPE-B, SIDE-A COMPARED TO SCANS B1-B6

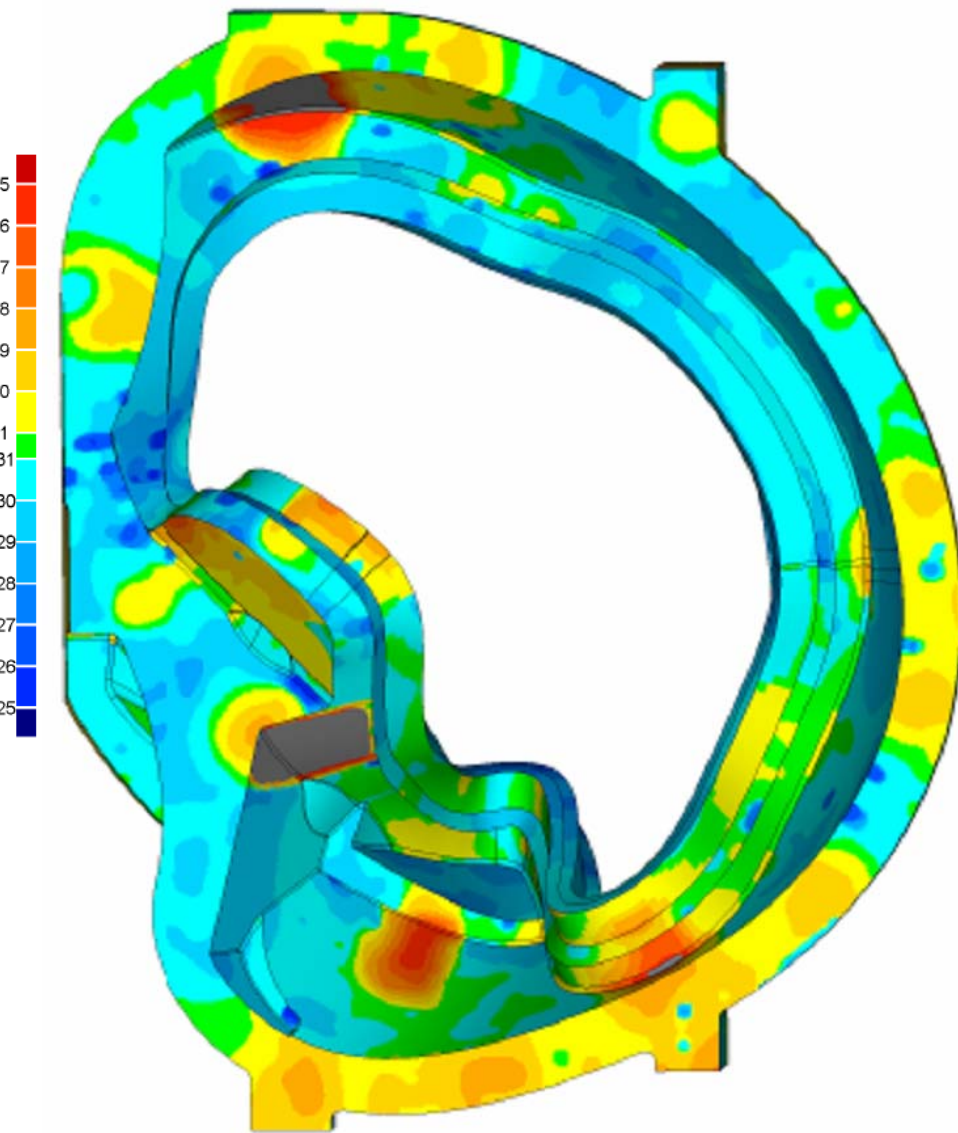

MCWF-B1

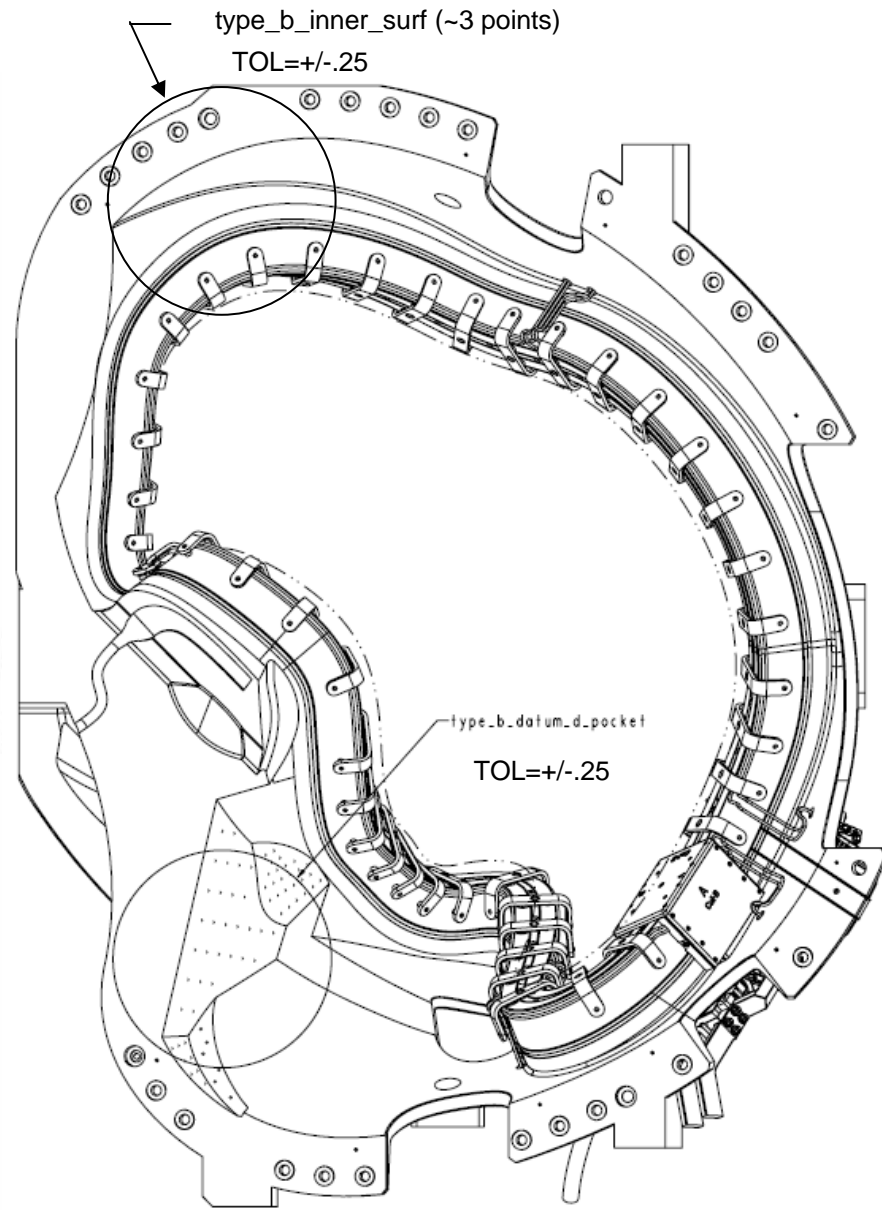

TYPE-B SIDE-A
(FLANGE DATUM-D)

GAP BETWEEN MCWF A, B

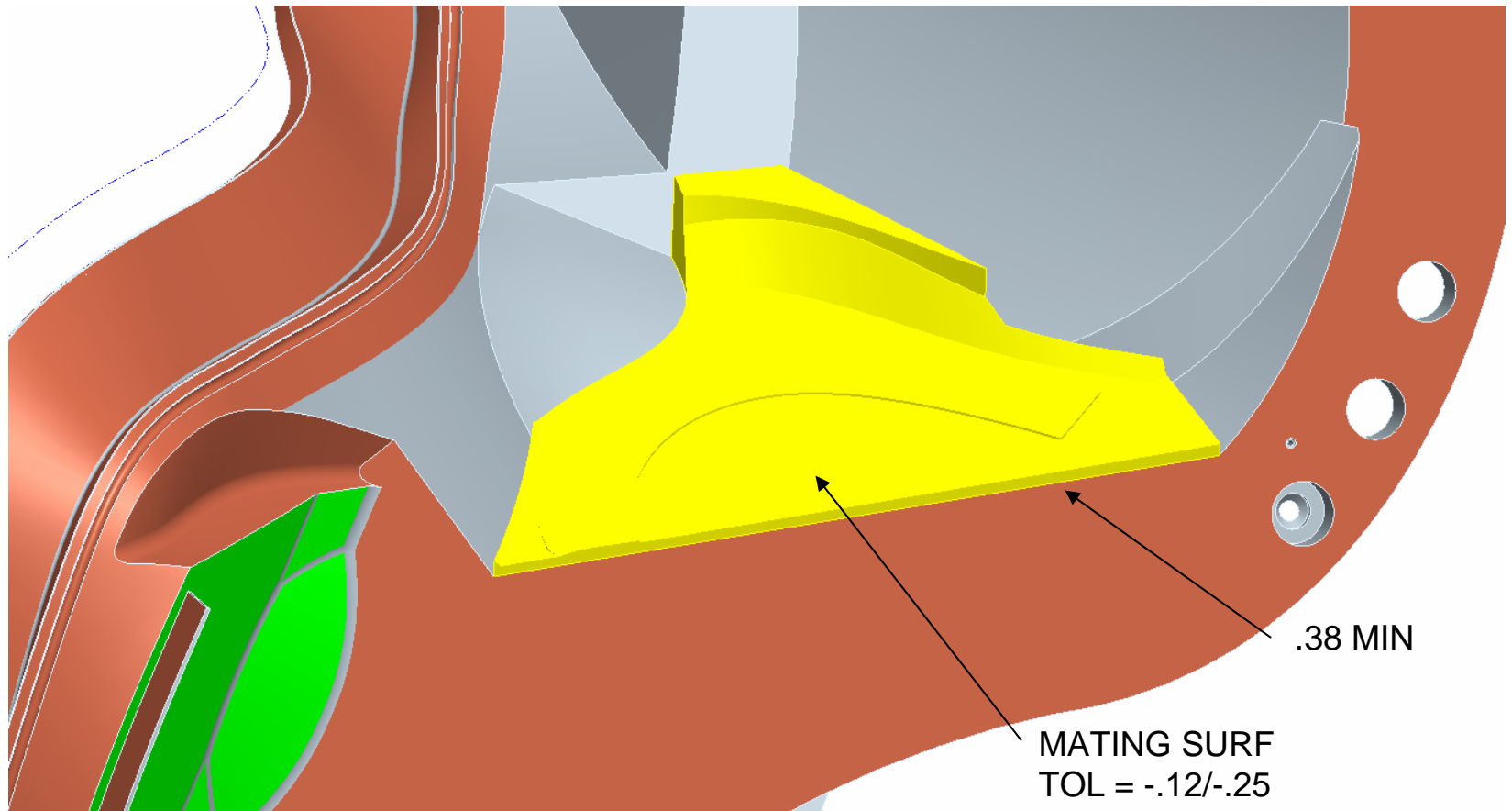
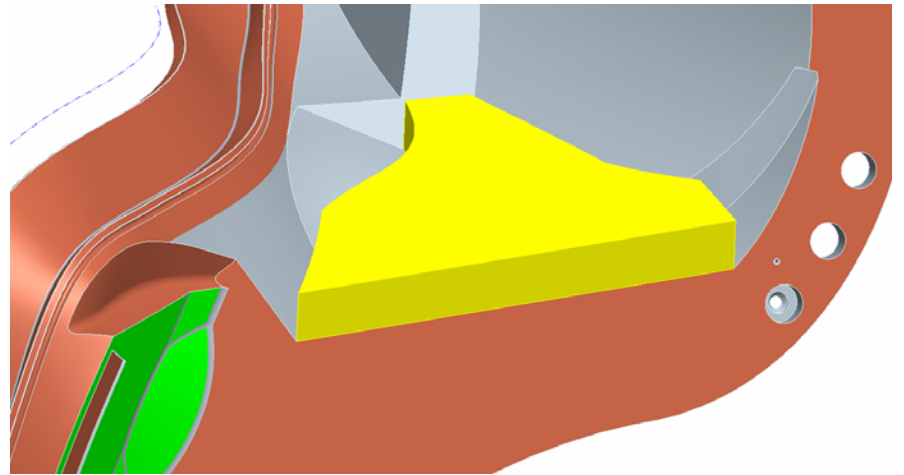
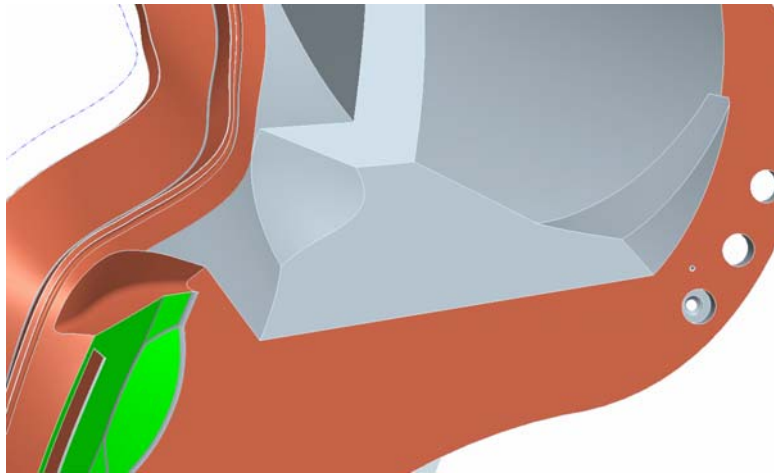

TOP SURF (B), TOL= +/- .25
BOT SURF (A), TOL= -.12/-.25
see se141-114, sht10, g6
wing not specifically noted

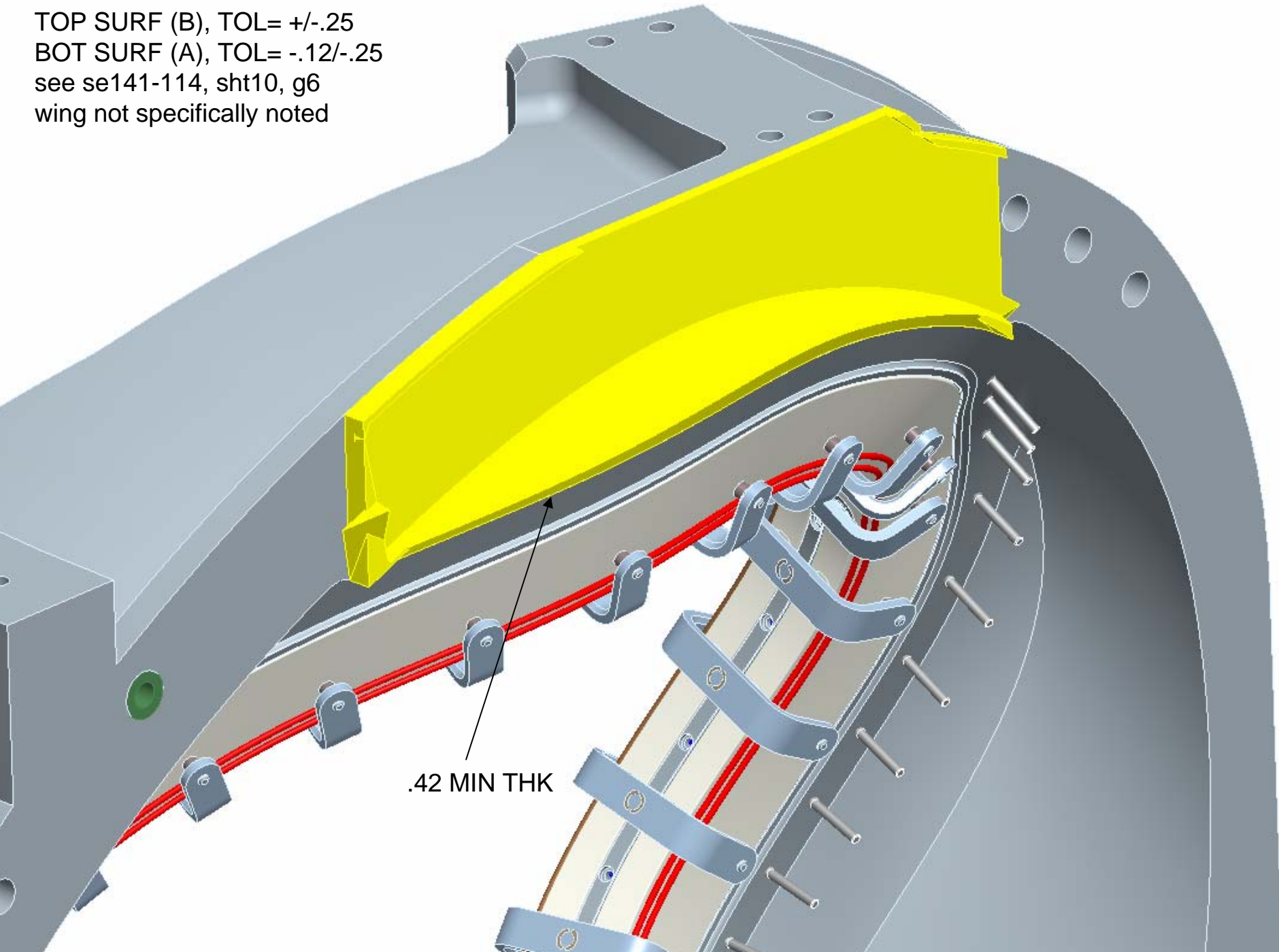

.42 MIN THK

COIL TO COIL INTERFACE B-C

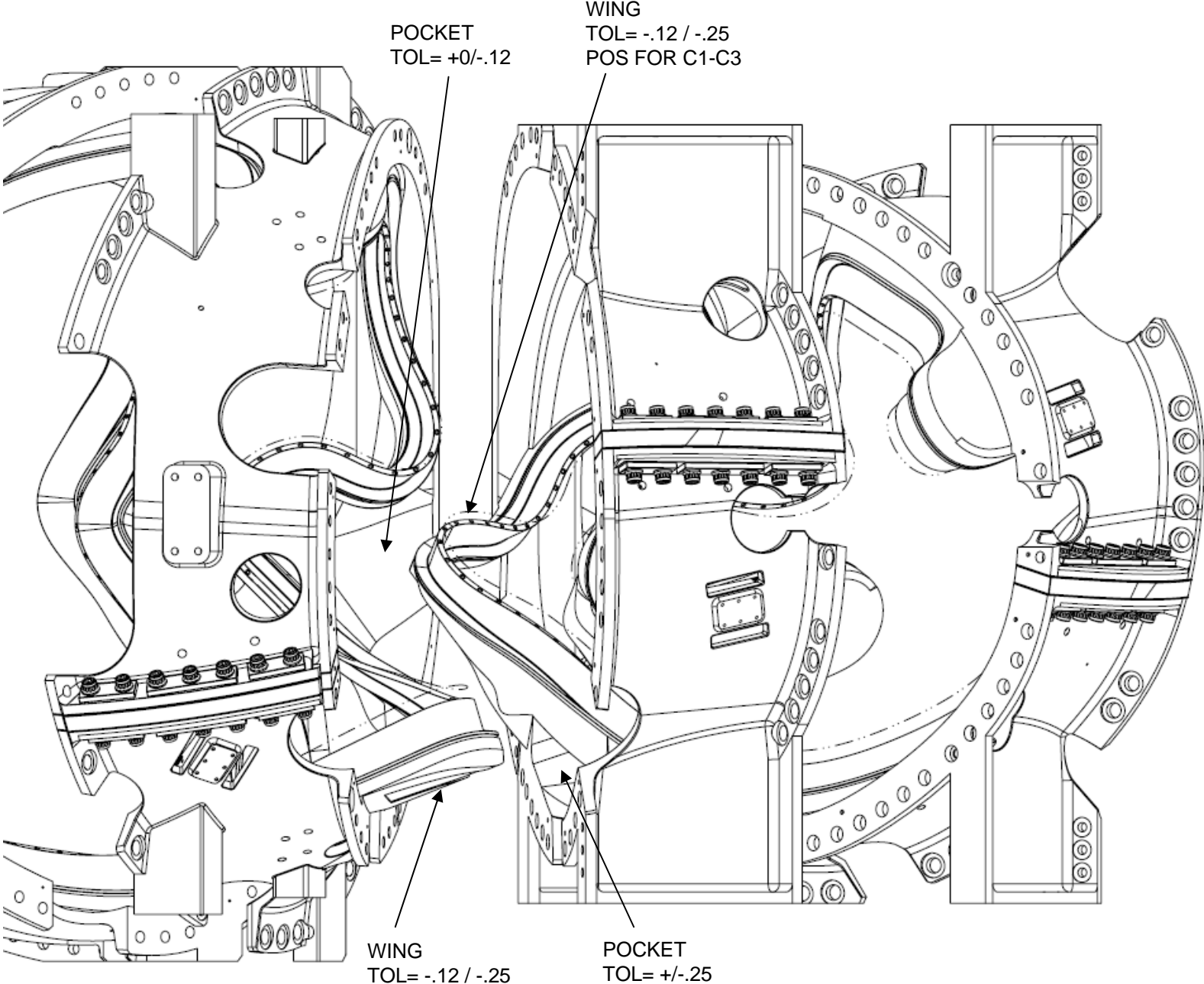

COIL TO COIL INTERFACE B-C

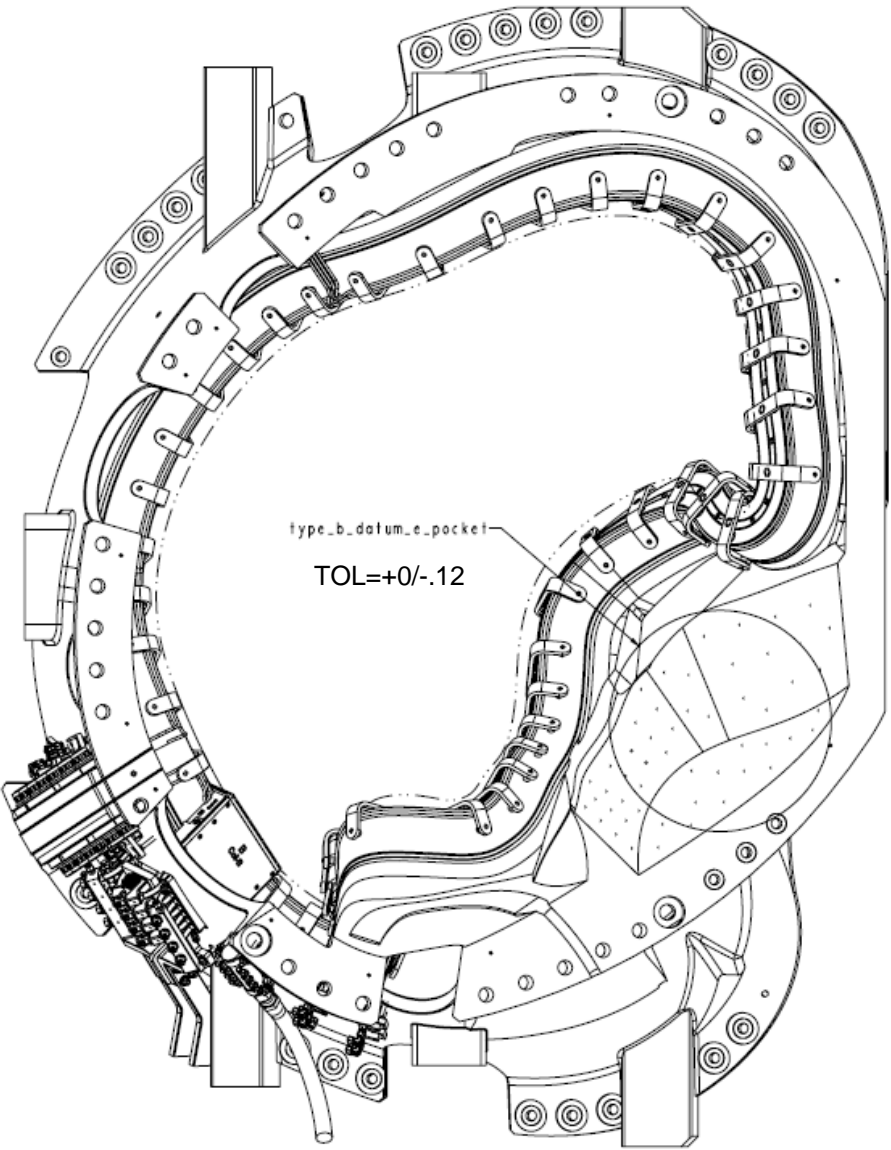

TYPE-B SIDE-B
(FLANGE DATUM-B)

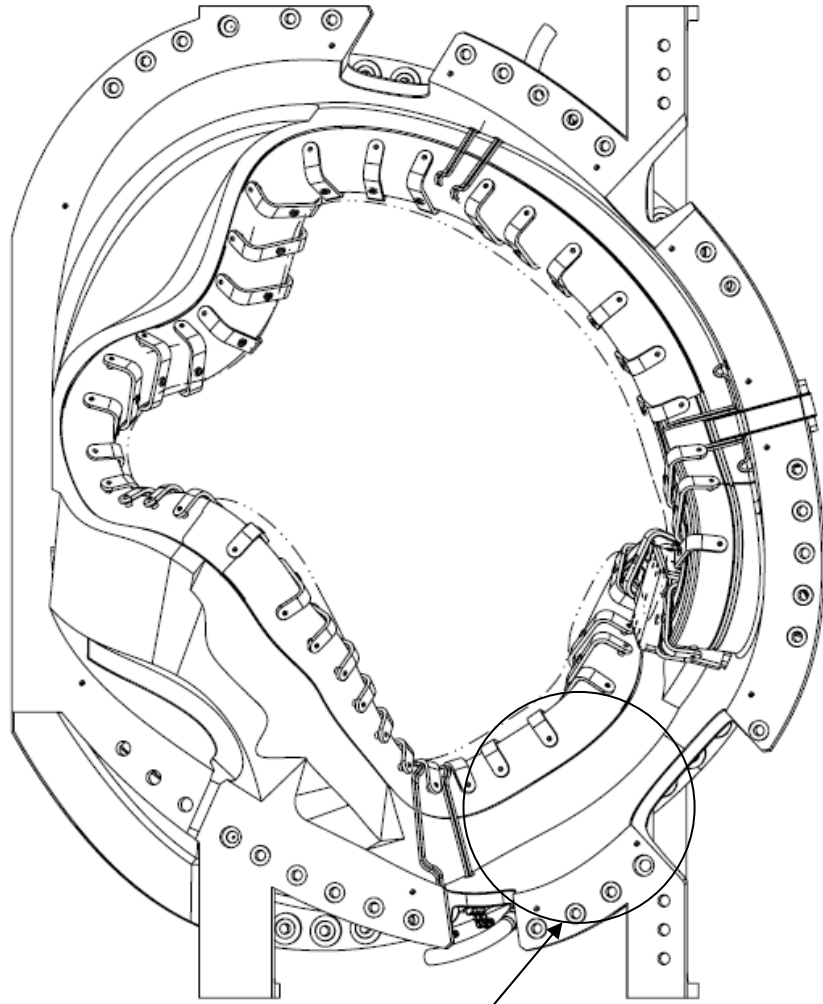

NOMINAL B-C
CLEARANCE = .27-IN
TOL=+/- .25

TYPE-C SIDE-A
(FLANGE DATUM-D)

TYPE-B, SIDE-B COMPARED TO SCANS B1-B6

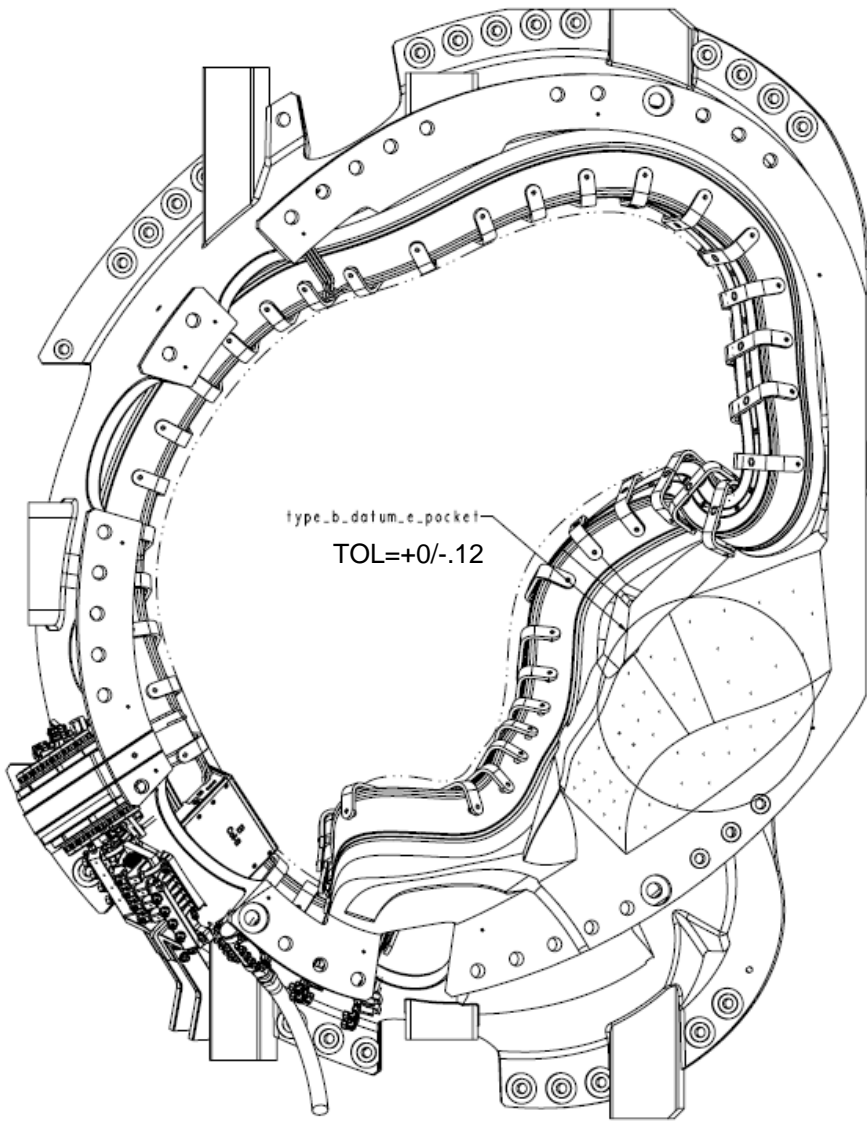

TYPE-B SIDE-B
(FLANGE DATUM#)

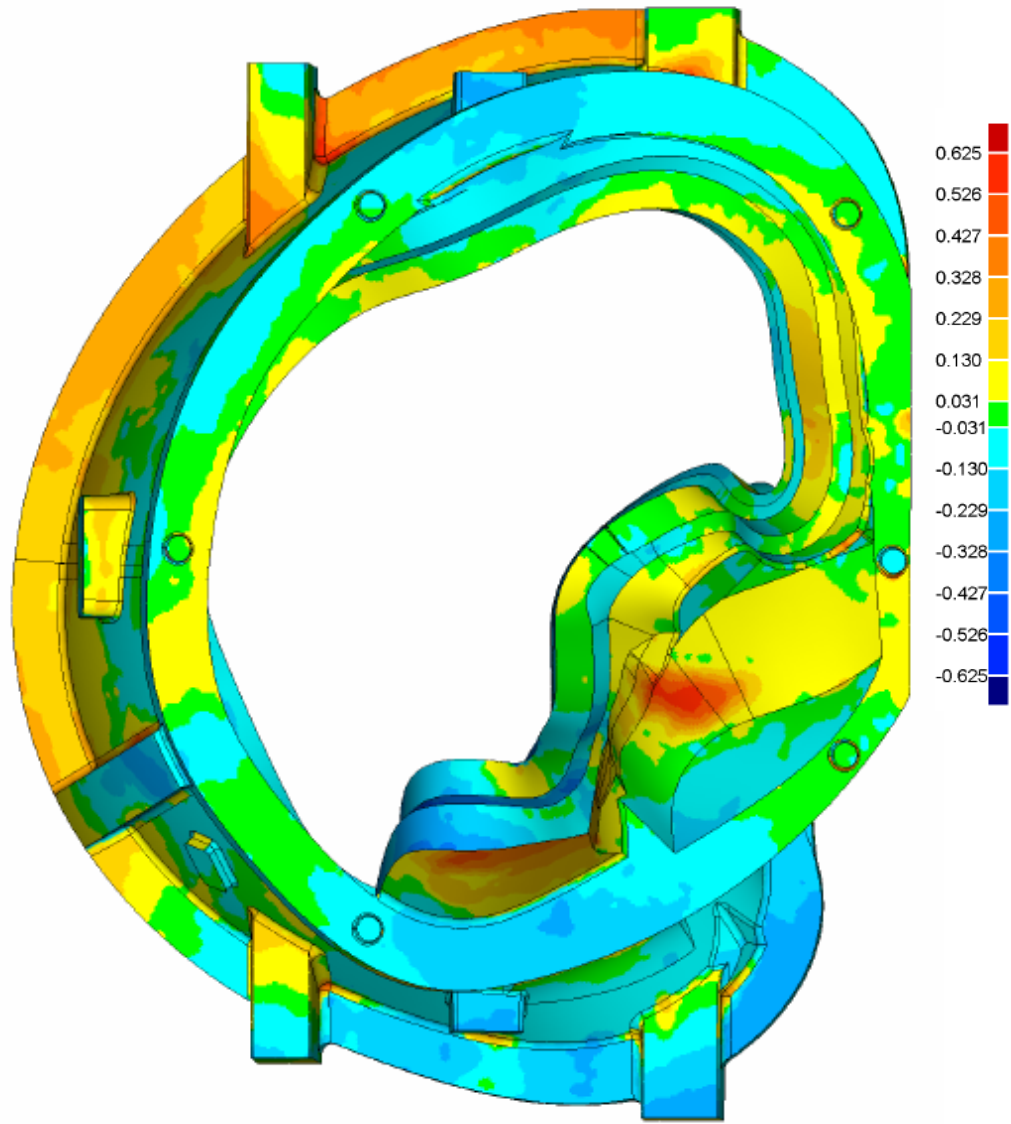

MCWF-B4

TYPE-C, SIDE-A COMPARED TO C4 FINAL

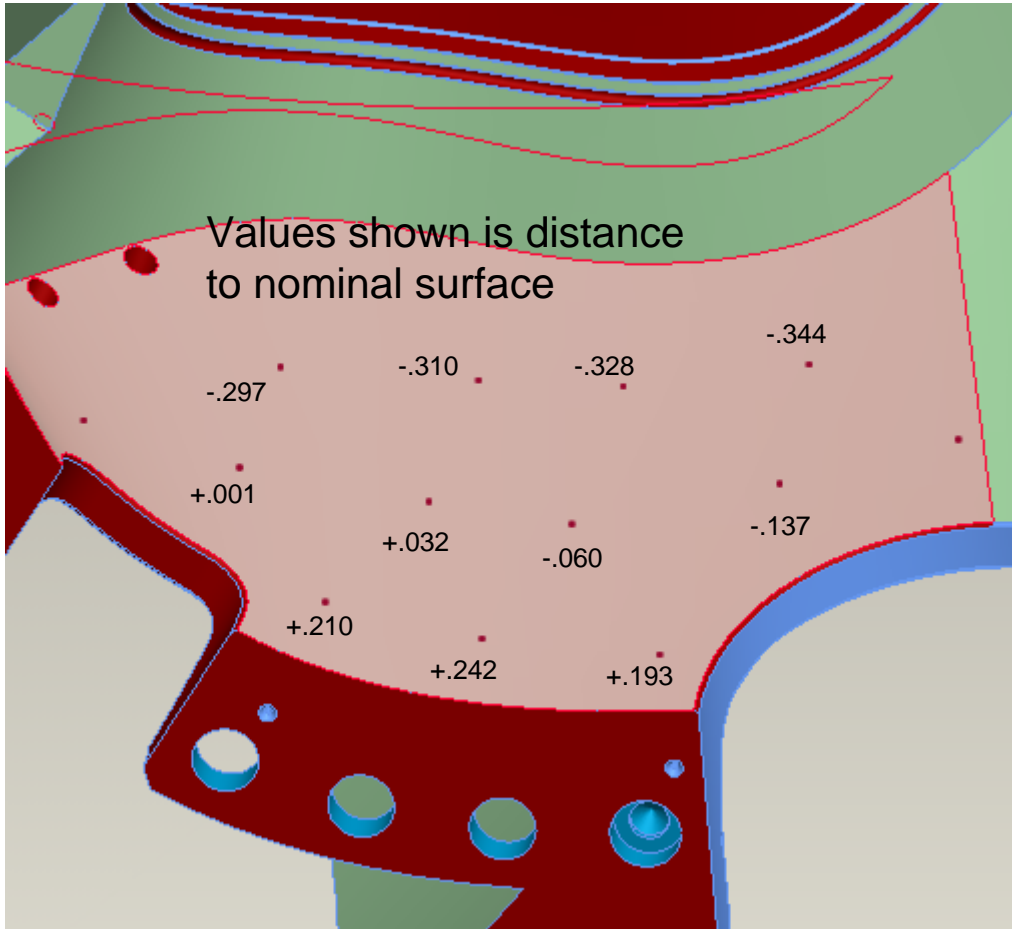

VERISURF DATA- C4

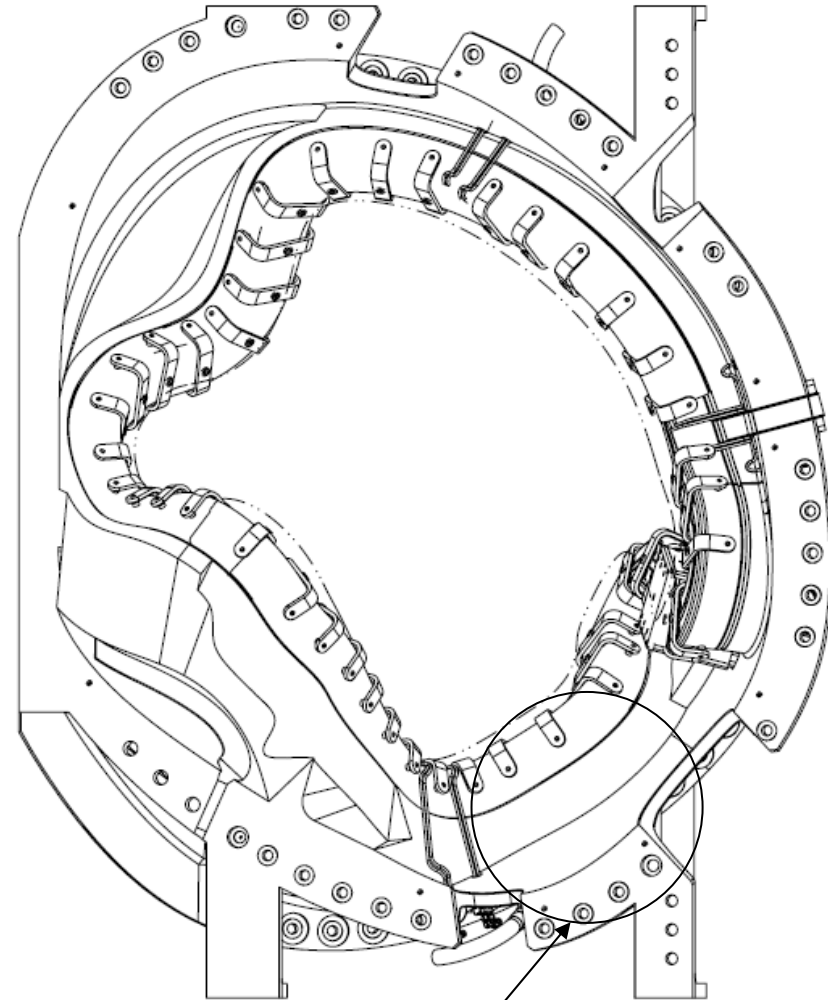

NOMINAL B-C
CLEARANCE = .27-IN
TOL=+/- .25

TYPE-C SIDE-A
(FLANGE DATUM-D)

COIL TO COIL INTERFACE C-C

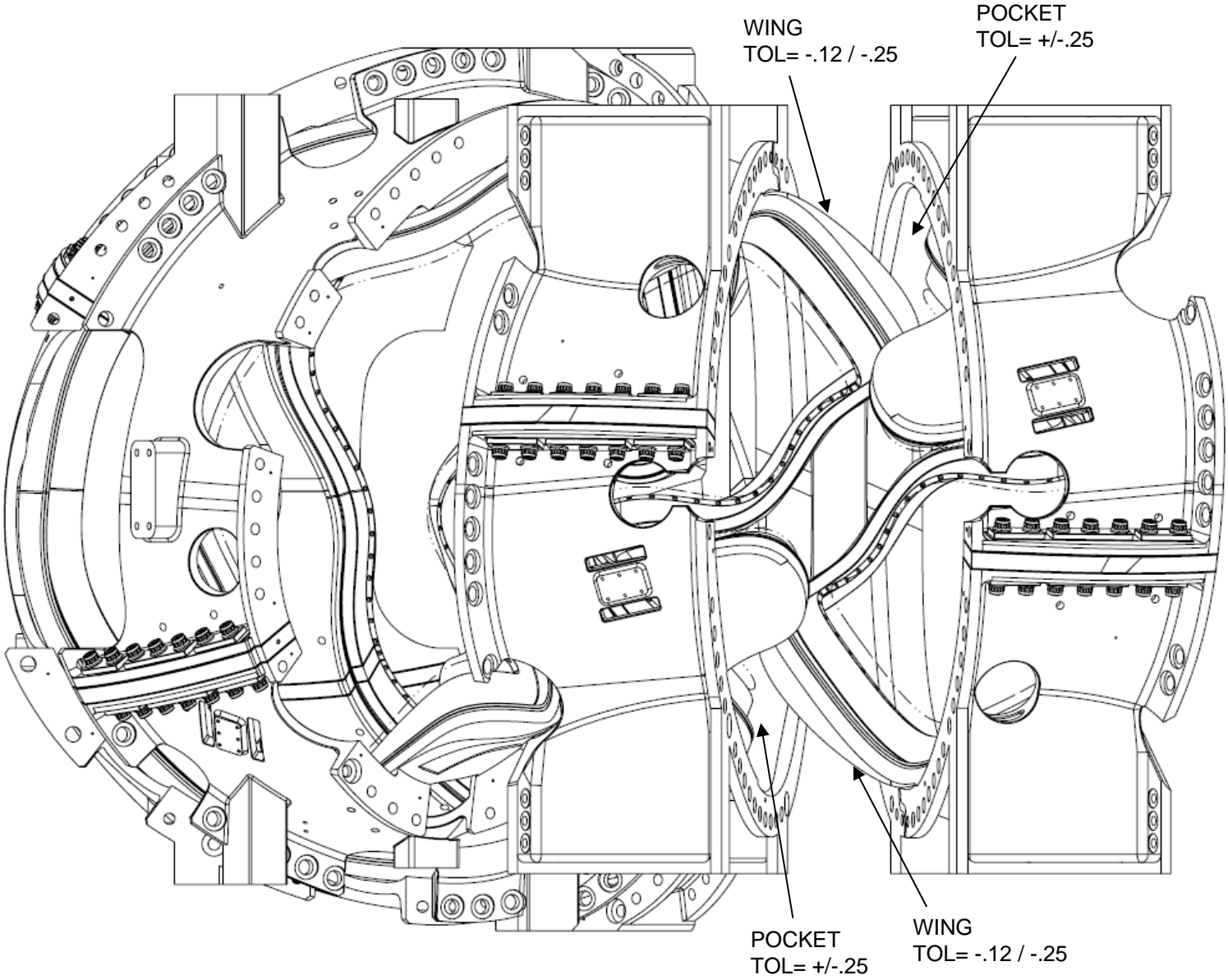

COIL TO COIL INTERFACE C-C

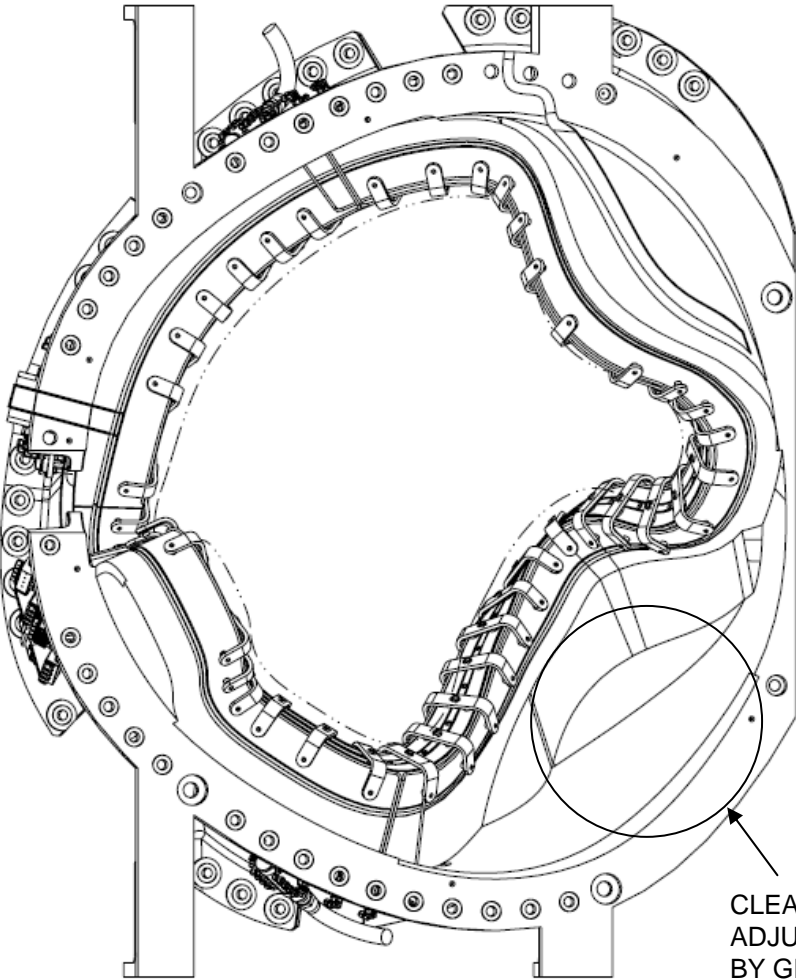

CLEARANCE
ADJUSTED
BY GRINDING

**TYPE-C SIDE-B
(FLANGE DATUM-E)**

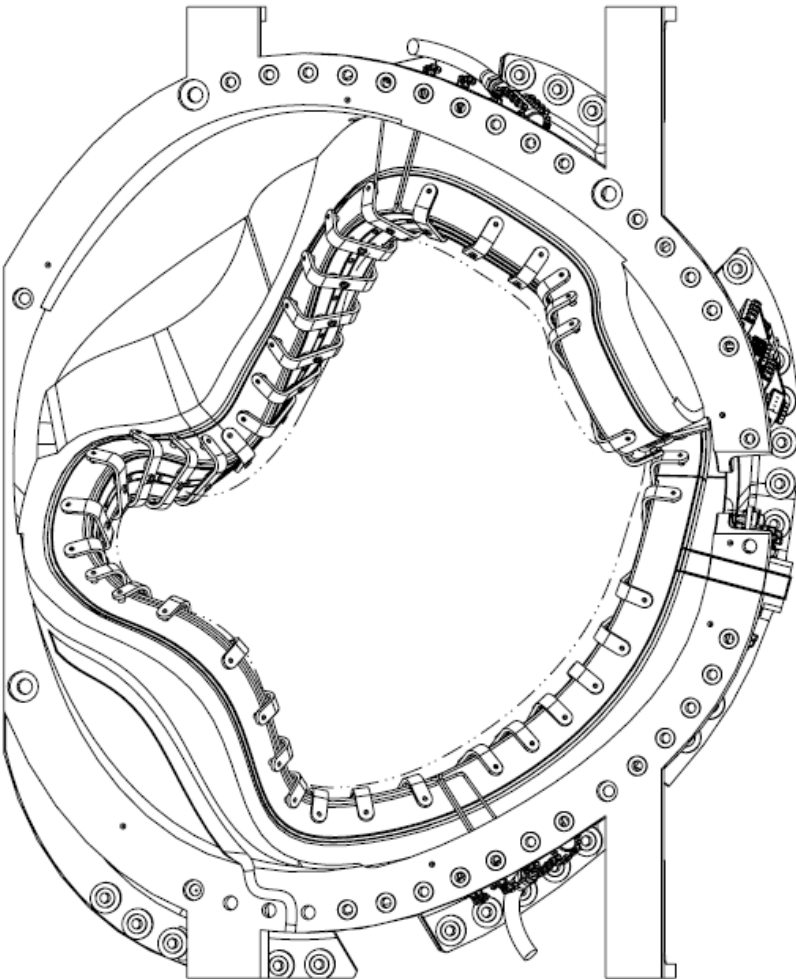

**TYPE-C SIDE-B
(FLANGE DATUM-E)**

TYPE-C, SIDE-B COMPARED TO C4 FINAL

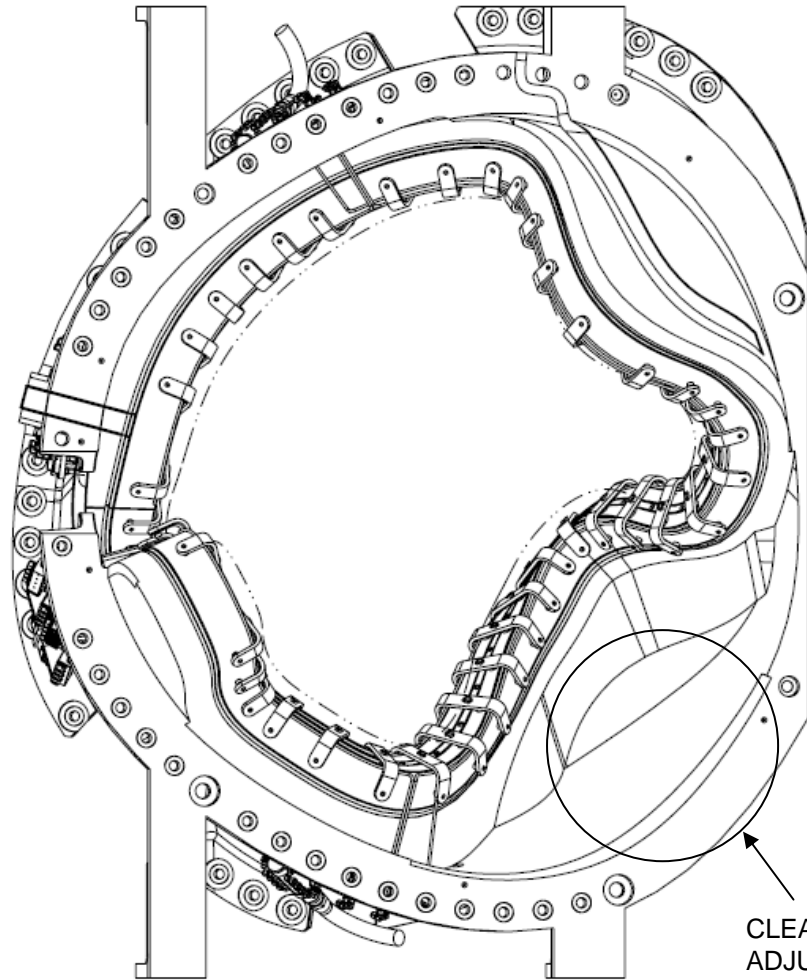

CLEARANCE
ADJUSTED
BY GRINDING

TYPE-C SIDE-B
(FLANGE DATUM-E)

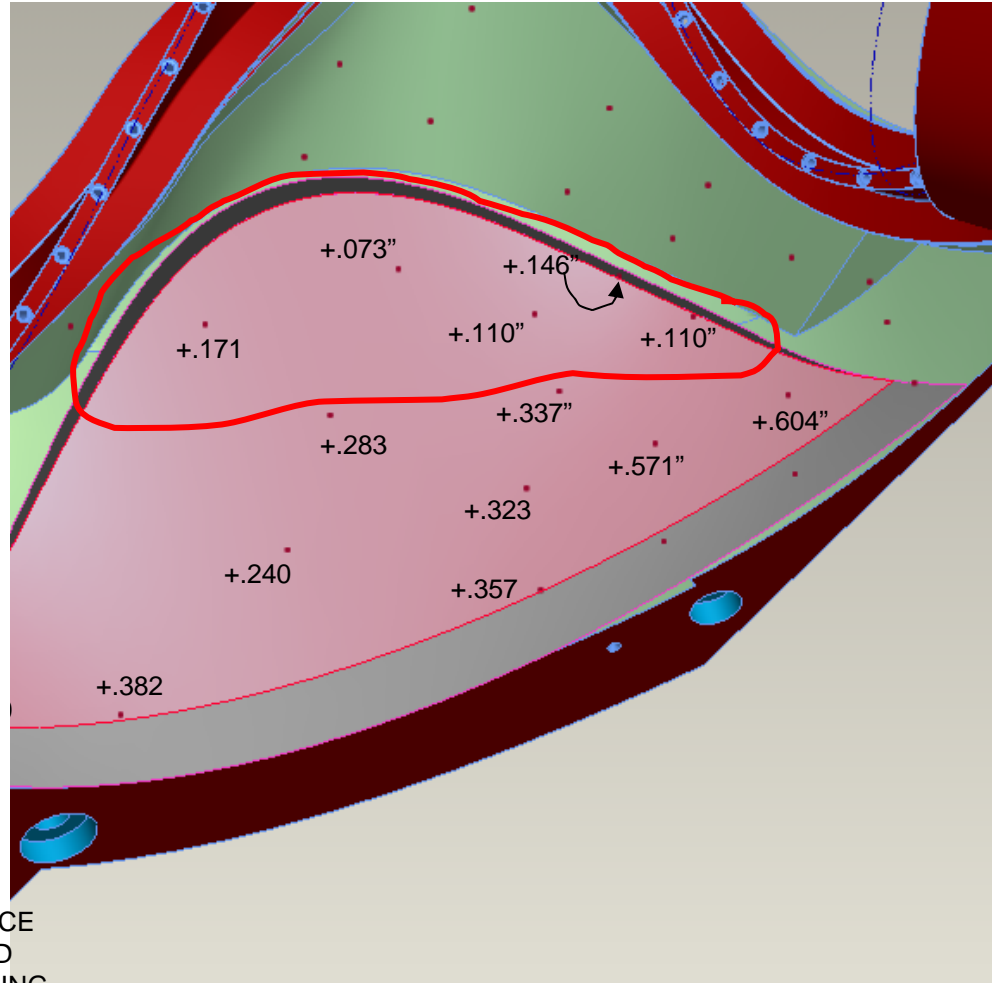

VERISURF DATA- C4