

NO CHILL PLATE

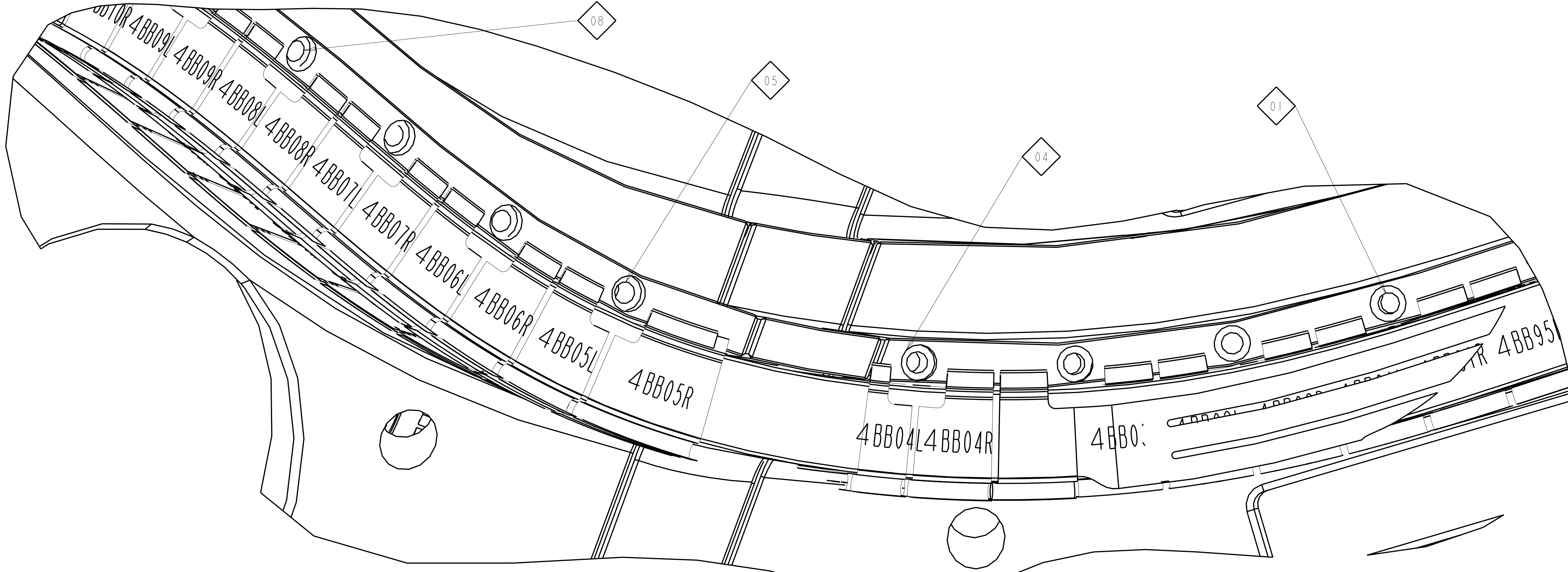

PARTIAL ISOMETRIC VIEW  
SCALE 1.00

RELEASED FOR FABRICATION / INSTALLATION  
PPPL Drafting:

UT-BATTELLE		Oak Ridge National Laboratory managed for the DEPARTMENT OF ENERGY under U.S. GOVERNMENT contract DE-AC05-00OR22725 UT-BATTELLE, LLC, Oak Ridge, Tennessee	
PROJECT NAME			
NATIONAL COMPACT STELLARATOR EXPERIMENT			
MODULAR COIL TYPE - B			
SIDE - B CLADDING AND CHILL PLATES			
FLAT PATTERN LAYOUT			
VERSION NO.	PLANT	BLDG	FL   SHT OF   TYPE   CLASS
16	X-10	5700	3   2   11   U   S
RELEASE LEVEL		Fabrication	
SE 142B-242		REV 0	

242-0243

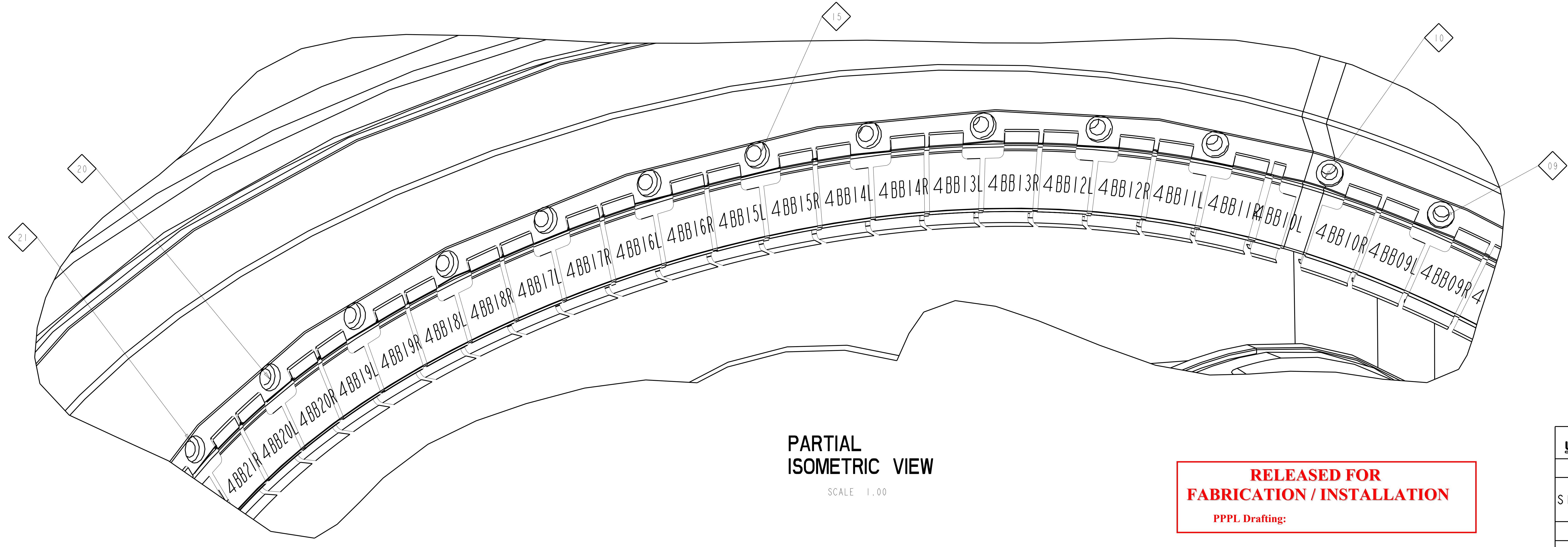
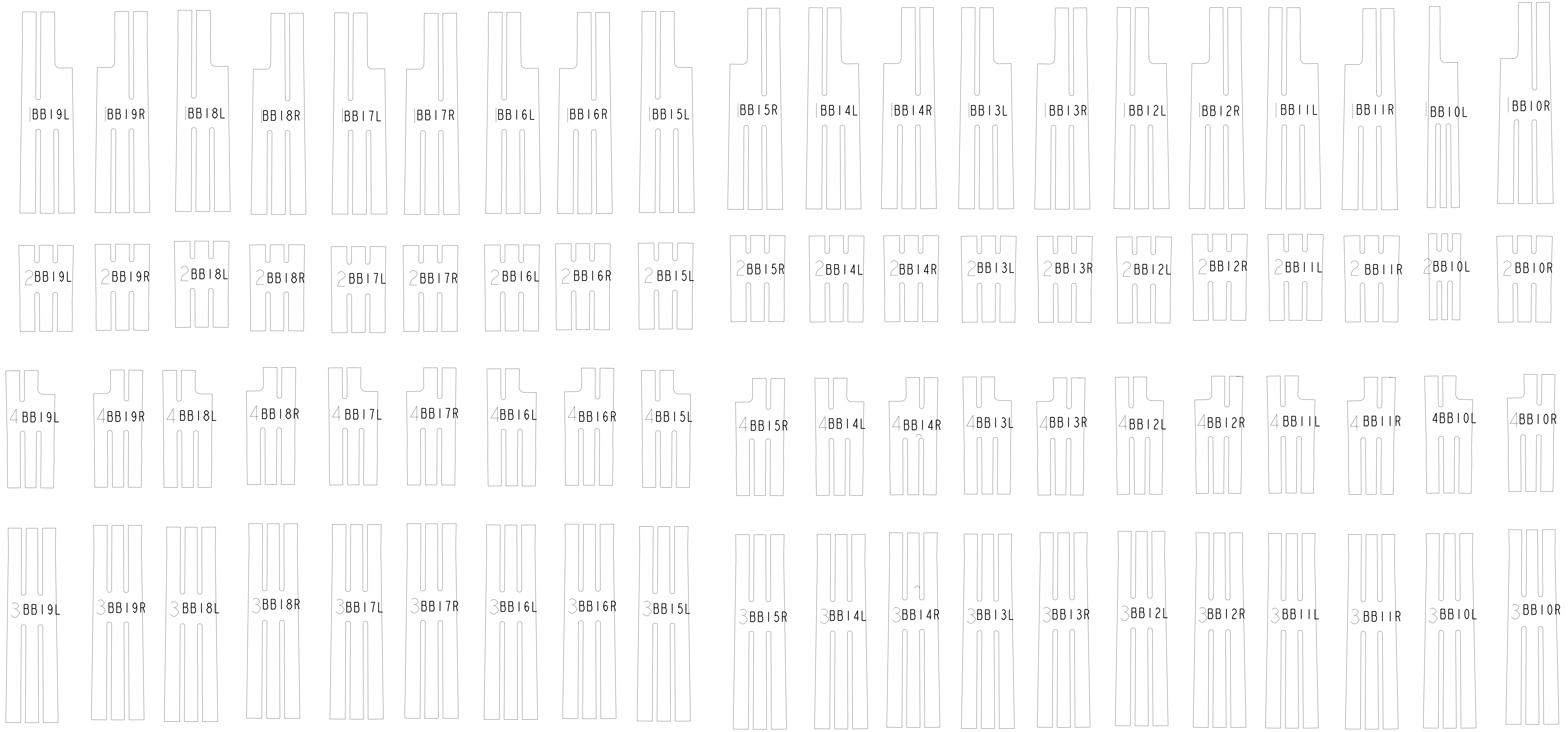

**PARTIAL ISOMETRIC VIEW**  
SCALE 1.00

**RELEASED FOR FABRICATION / INSTALLATION**  
PPPL Drafting:

Oak Ridge National Laboratory managed for the DEPARTMENT OF ENERGY under U.S. GOVERNMENT contract DE-AC05-00OR22725 UT-BATTELLE, LLC, Oak Ridge, Tennessee PROJECT NAME:									
<b>NATIONAL COMPACT STELLARATOR EXPERIMENT</b>									
MODULAR COIL TYPE - B SIDE - B CLADDING AND CHILL PLATES FLAT PATTERN LAYOUT									
VERSION NO:	PLANT	BLDG	FL	SHT	OF	TYPE	CLASS		
16	X-10	5700	3	3	11	U	S		
RELEASE LEVEL		SE 142B-242						REV	
Fabrication								0	

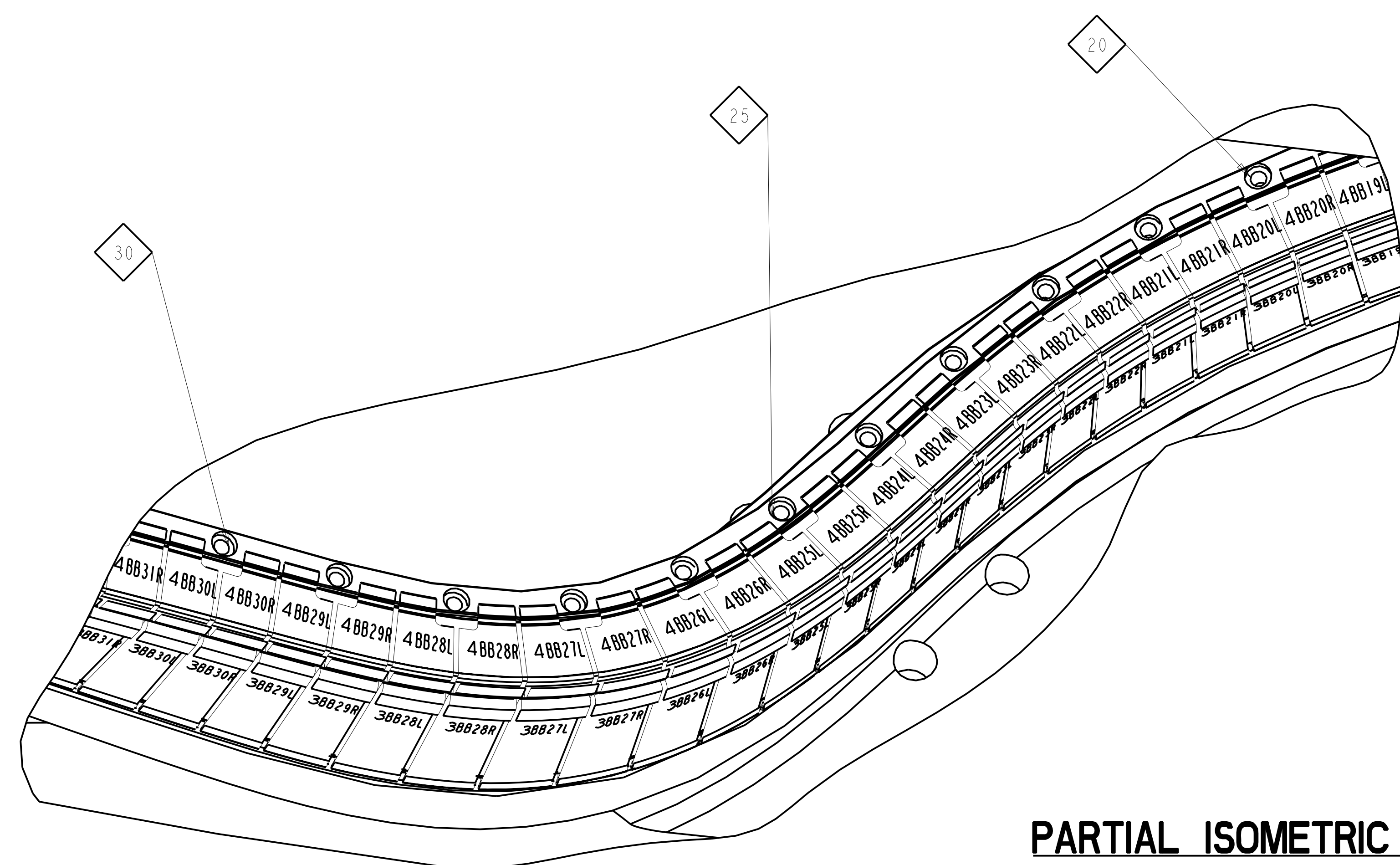
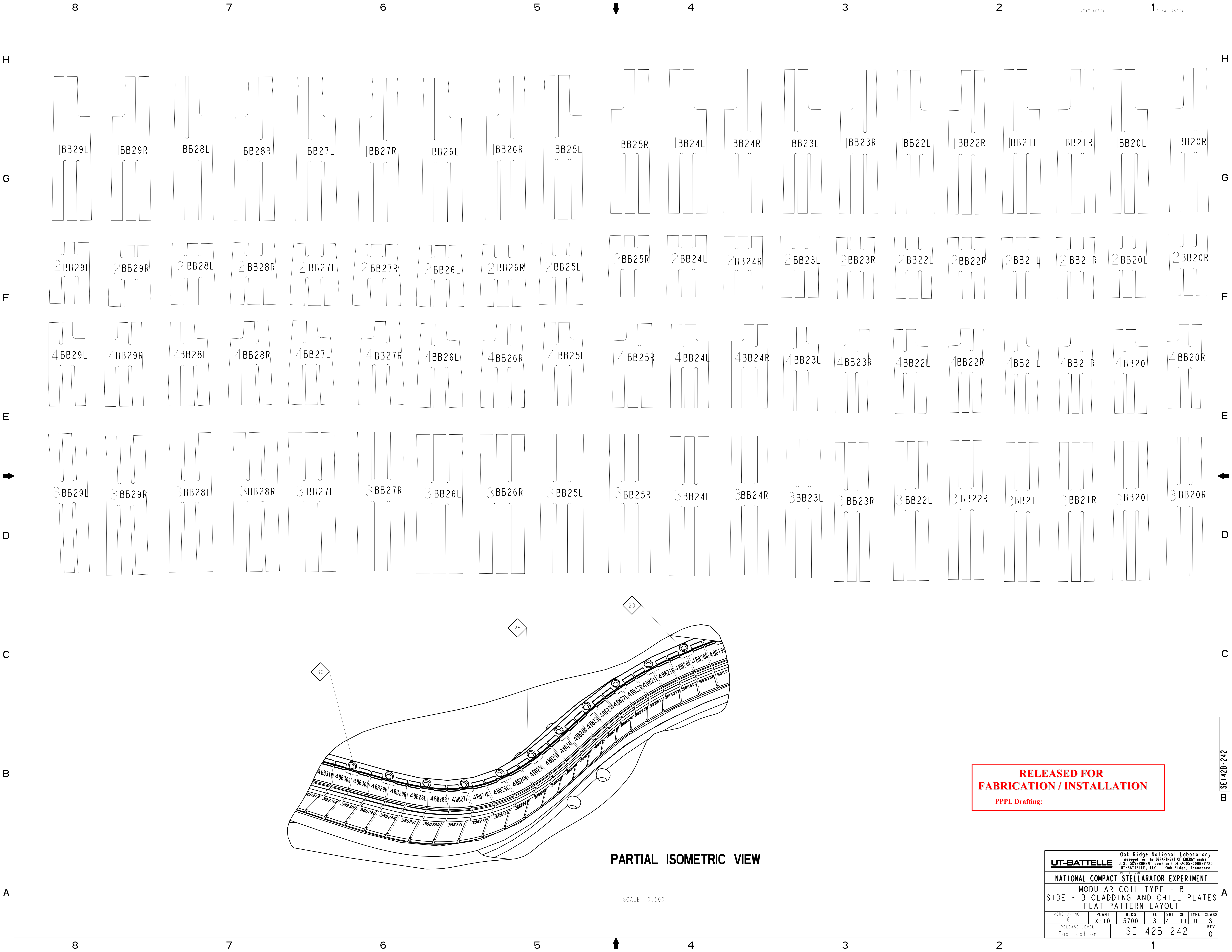

**PARTIAL ISOMETRIC VIEW**

SCALE 0.500

**RELEASED FOR  
FABRICATION / INSTALLATION**  
PPPL Drafting:

<small>Oak Ridge National Laboratory managed for the DEPARTMENT OF ENERGY under U.S. GOVERNMENT contract DE-AC05-00OR22725 UT-BATTELLE, LLC, Oak Ridge, Tennessee</small>							
<b>UT-BATTELLE</b>							
PROJECT NAME							
<b>NATIONAL COMPACT STELLARATOR EXPERIMENT</b>							
MODULAR COIL TYPE - B							
SIDE - B CLADDING AND CHILL PLATES							
FLAT PATTERN LAYOUT							
VERSION NO.	PLANT	BLDG	FL	SHT	OF	TYPE	CLASS
16	X-10	5700	3	4	11	U	S
RELEASE LEVEL		SE 142B-242					
Fabrication		REV 0					

242-024-135  
B SE 142B-242

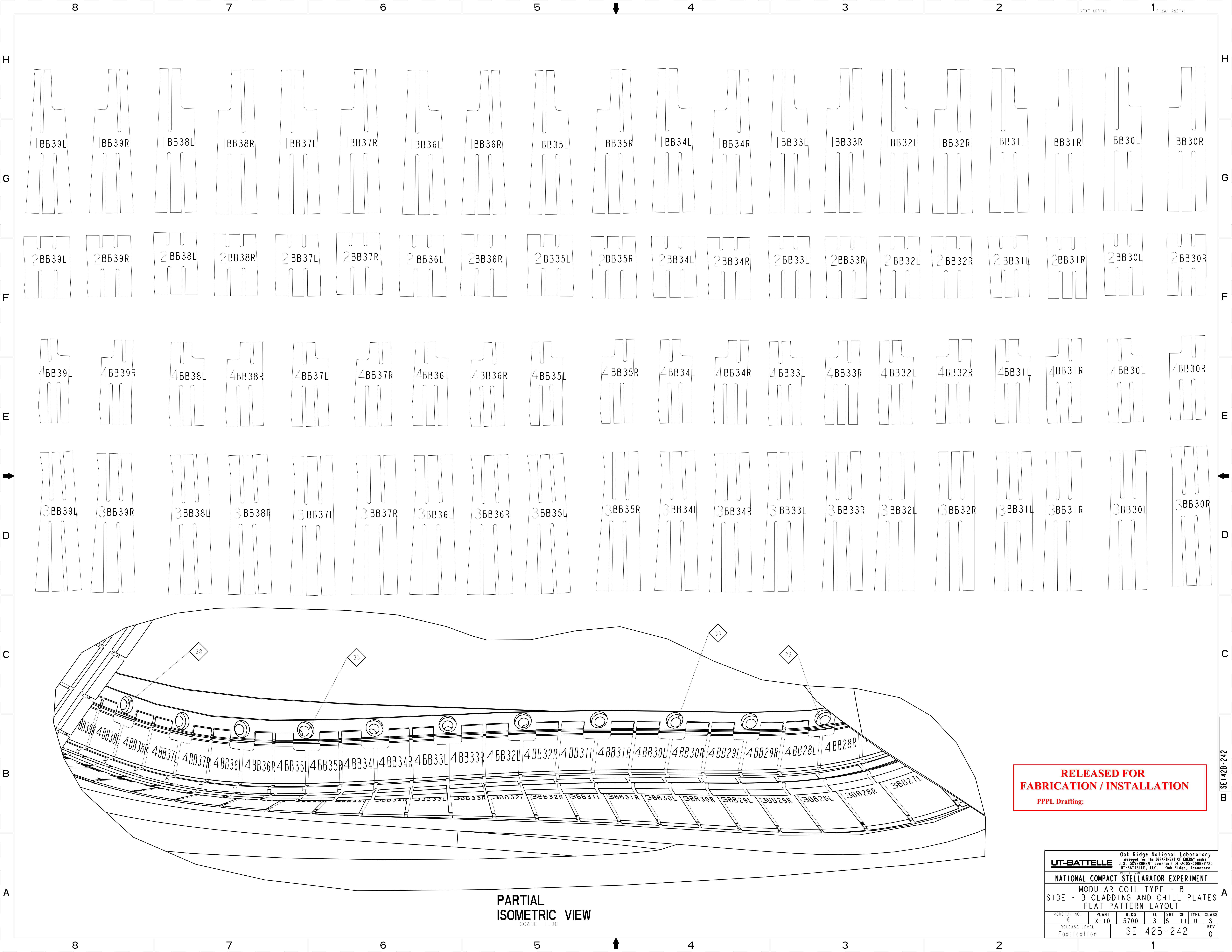

**RELEASED FOR  
FABRICATION / INSTALLATION**  
PPPL Drafting:

**PARTIAL  
ISOMETRIC VIEW**  
SCALE 1:00

Oak Ridge National Laboratory managed for the DEPARTMENT OF ENERGY under U.S. GOVERNMENT contract DE-AC05-00OR22725 UT-BATTELLE, LLC, Oak Ridge, Tennessee PROJECT 3046							
<b>NATIONAL COMPACT STELLARATOR EXPERIMENT</b>							
MODULAR COIL TYPE - B SIDE - B CLADDING AND CHILL PLATES FLAT PATTERN LAYOUT							
VERSION NO:	PLANT	BLDG	FL	SHT	OF	TYPE	CLASS
16	X-10	5700	3	5	11	U	S
RELEASE LEVEL		SE 142B-242				REV	
Fabrication						0	

242-02435

8

7

6

5

4

3

2

1

NEXT ASS'Y:

1 FINAL ASS'Y:

H

H

G

G

F

F

E

E

D

D

C

C

B

B

A

A

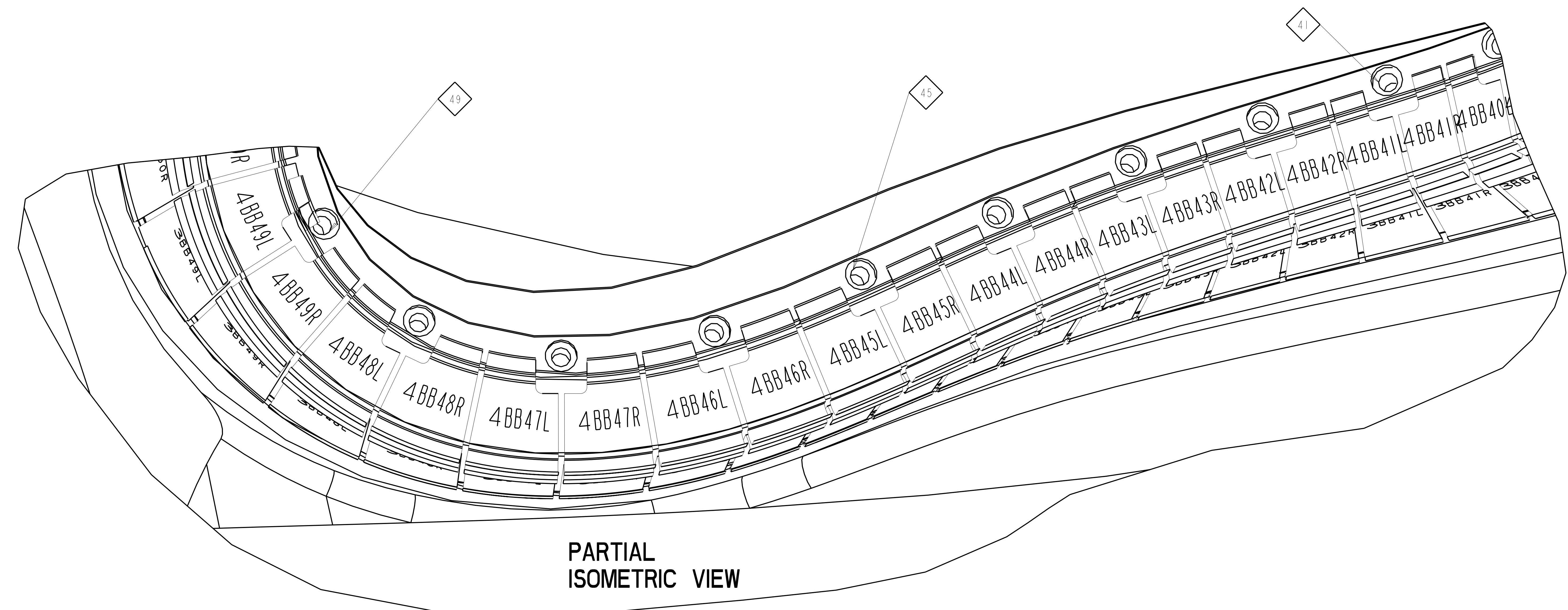
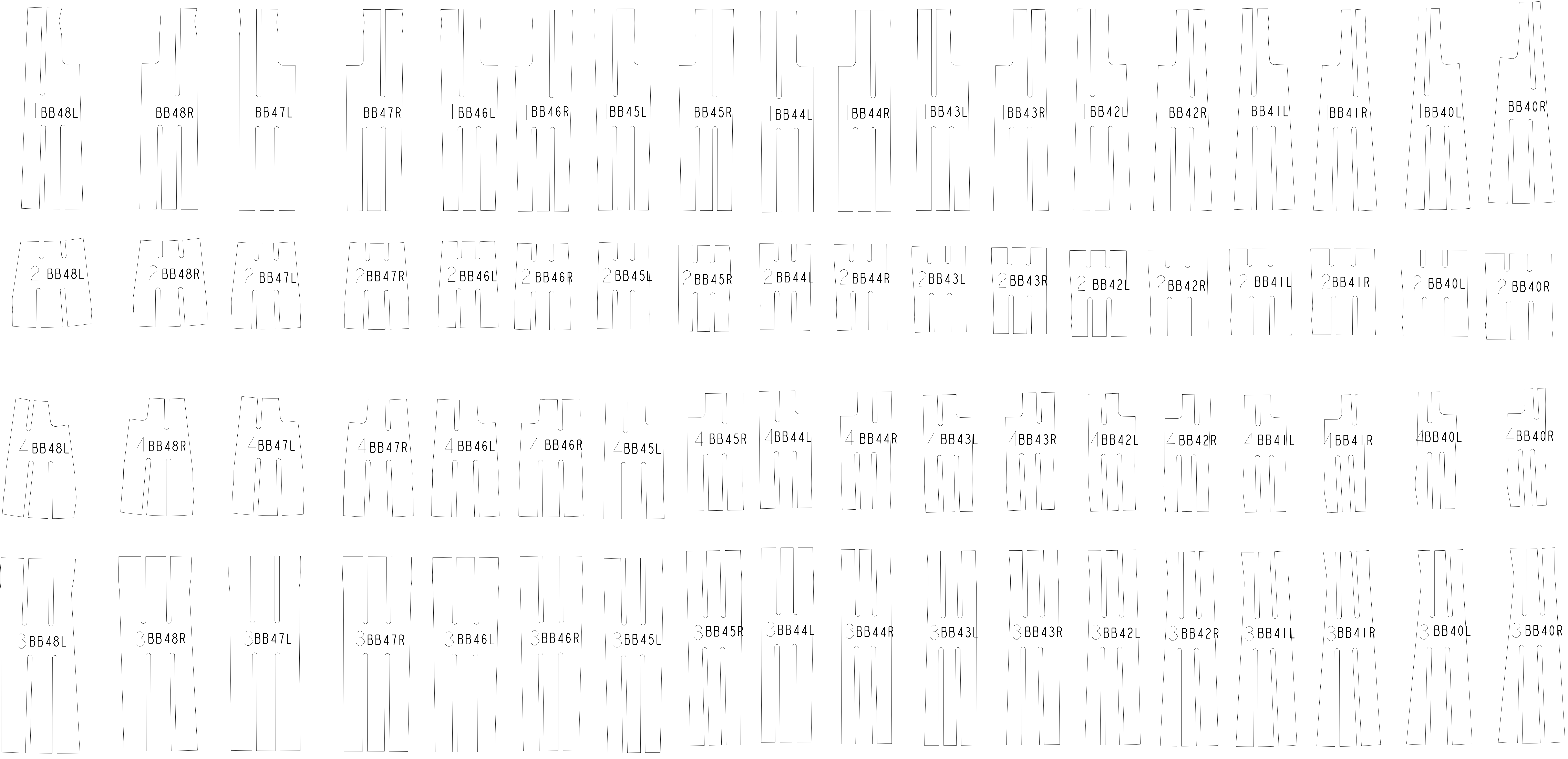

**RELEASED FOR FABRICATION / INSTALLATION**  
 PPPL Drafting:

UT-BATTELLE		Oak Ridge National Laboratory managed for the DEPARTMENT OF ENERGY under U.S. GOVERNMENT CONTRACT DE-AC05-00OR22725 UT-BATTELLE, LLC, Oak Ridge, Tennessee	
PROJECT NAME			
NATIONAL COMPACT STELLARATOR EXPERIMENT			
MODULAR COIL TYPE - B			
SIDE - B CLADDING AND CHILL PLATES			
FLAT PATTERN LAYOUT			
VERSION NO.	PLANT	BLDG	FL   SHT OF   TYPE   CLASS
16	X-10	5700	3   6   11   U   S
RELEASE LEVEL		SE 142B-242	
Fabrication		REV 0	

8

7

6

5

4

3

2

1

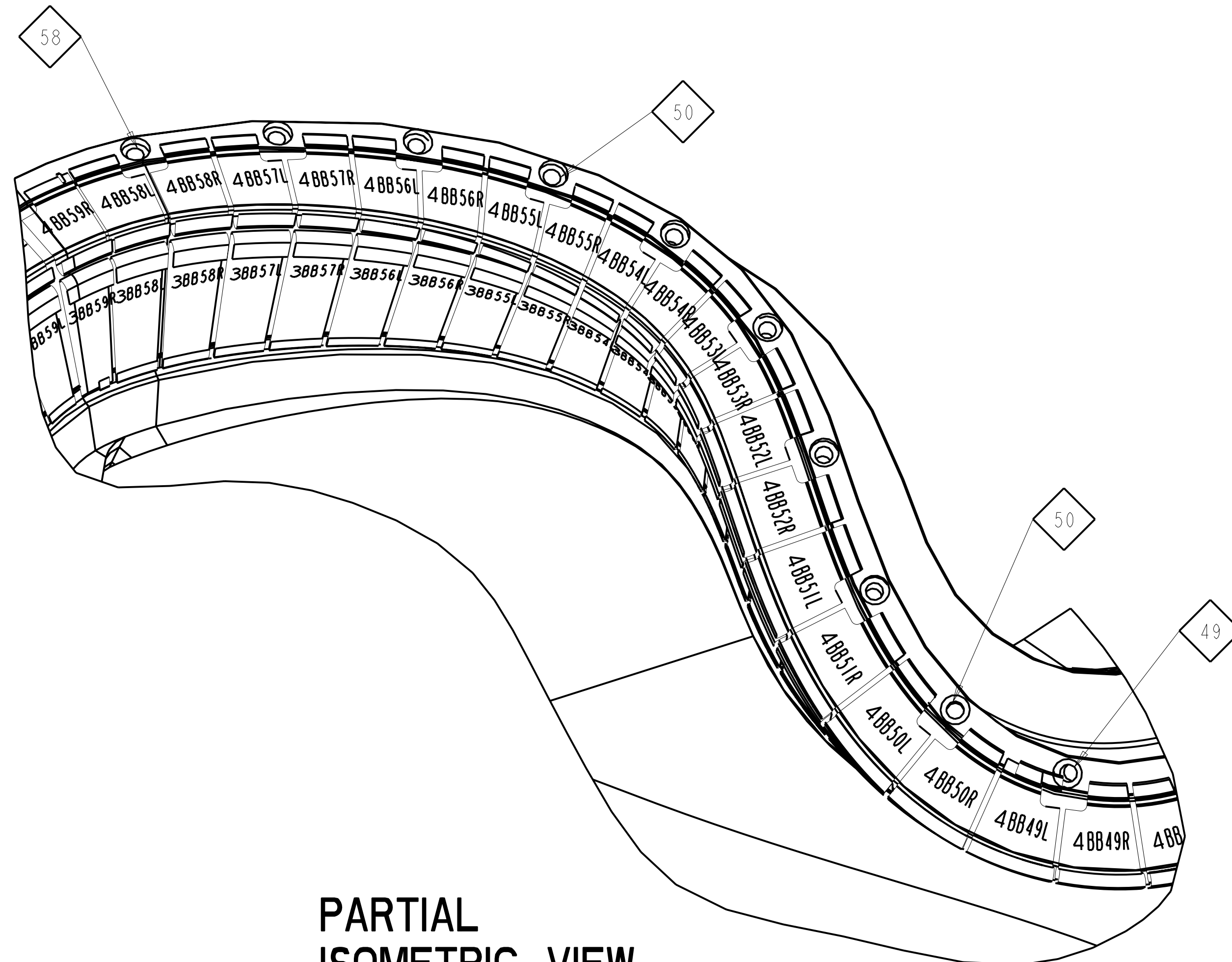
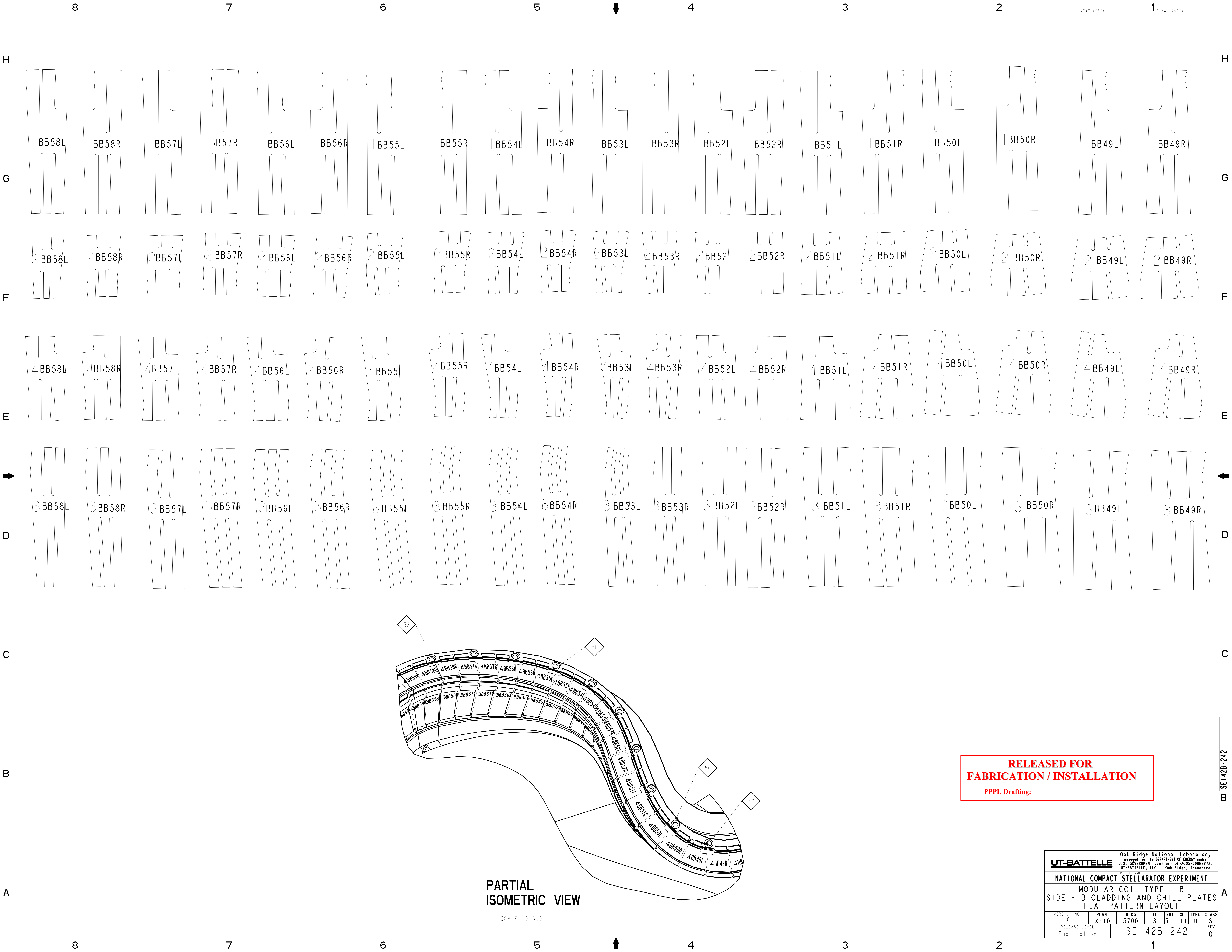

PARTIAL ISOMETRIC VIEW  
SCALE 0.500

**RELEASED FOR  
FABRICATION / INSTALLATION**  
PPPL Drafting:

Oak Ridge National Laboratory managed for the DEPARTMENT OF ENERGY under U.S. GOVERNMENT contract DE-AC05-00OR22725 UT-BATTELLE, LLC., Oak Ridge, Tennessee PROJECT NAME:							
<b>NATIONAL COMPACT STELLARATOR EXPERIMENT</b> MODULAR COIL TYPE - B SIDE - B CLADDING AND CHILL PLATES FLAT PATTERN LAYOUT							
VERSION NO:	PLANT	BLDG	FL	SHT	OF	TYPE	CLASS
16	X-10	5700	3	7	11	U	S
RELEASE LEVEL		SE 142B-242		REV		0	
Fabrication							

242-02435  
B SE 142B-242

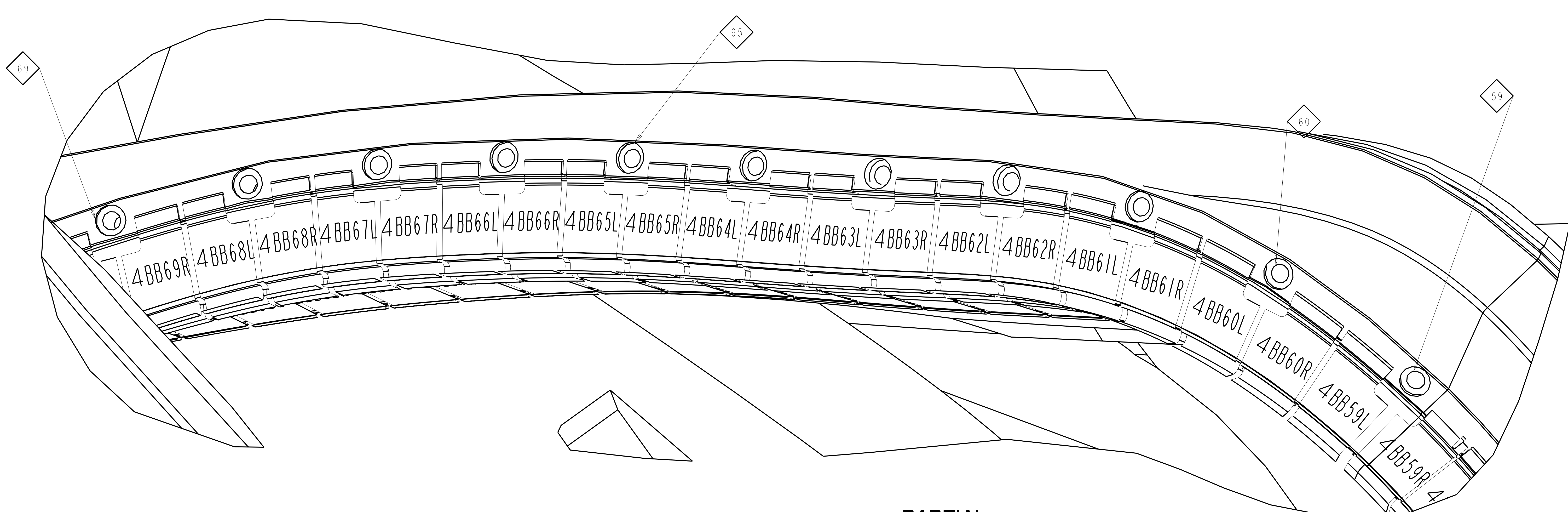
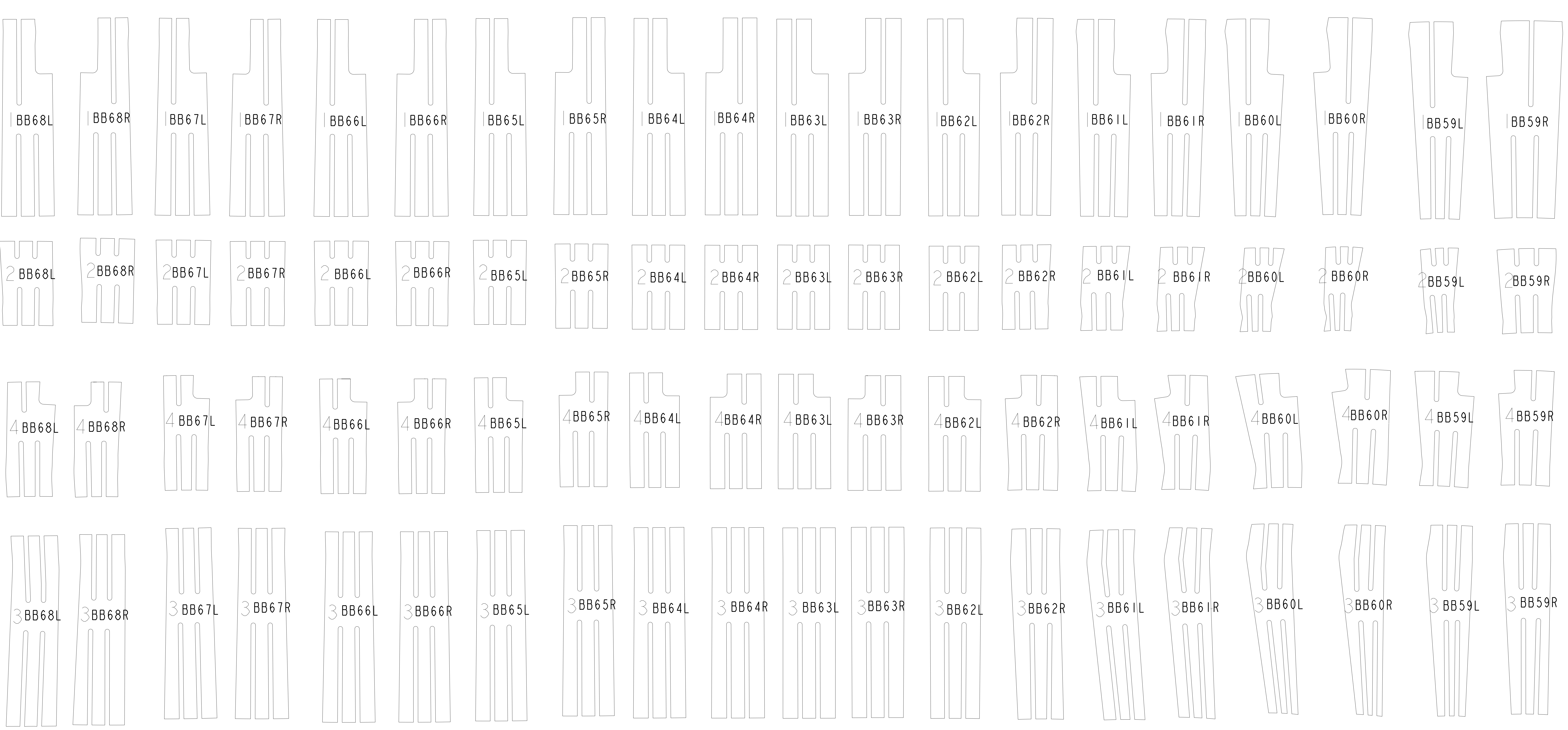

PARTIAL ISOMETRIC VIEW

SCALE 1.00

**RELEASED FOR FABRICATION / INSTALLATION**  
PPPL Drafting:

Oak Ridge National Laboratory managed for the DEPARTMENT OF ENERGY under U.S. GOVERNMENT CONTRACT DE-AC05-00OR22725 UT-BATTELLE, LLC., Oak Ridge, Tennessee PROJECT NAME:									
<b>NATIONAL COMPACT STELLARATOR EXPERIMENT</b> MODULAR COIL TYPE - B SIDE - B CLADDING AND CHILL PLATES FLAT PATTERN LAYOUT									
VERSION NO:	PLANT	BLDG	FL	SHT	OF	TYPE	CLASS		
16	X-10	5700	3	8	11	U	S		
RELEASE LEVEL		SE 142B-242		REV					
Fabrication				0					

242-024B-135



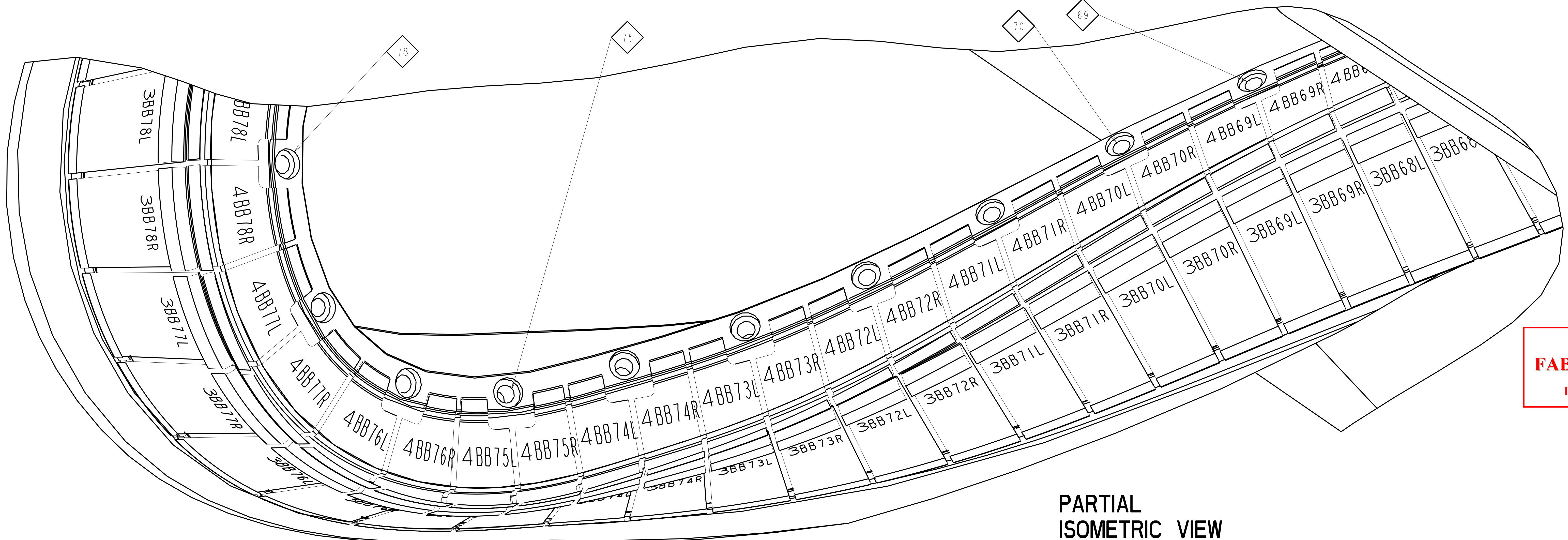
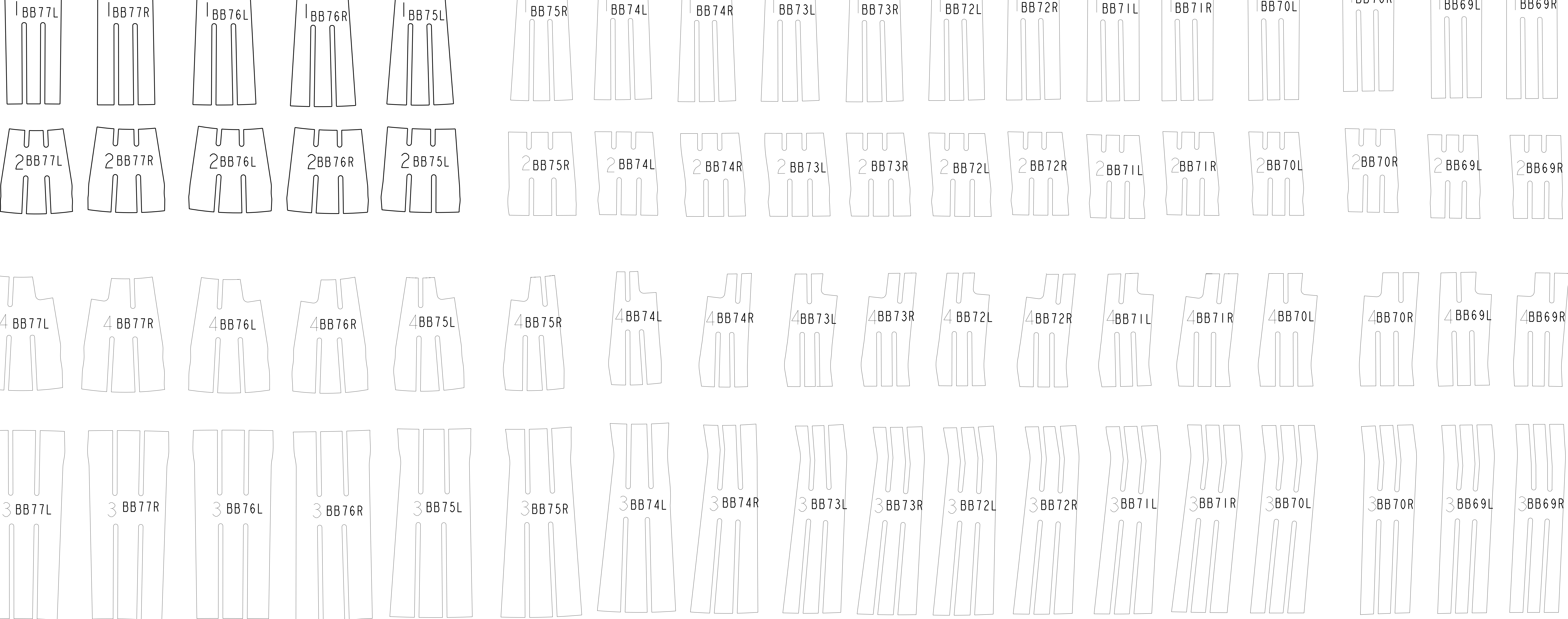
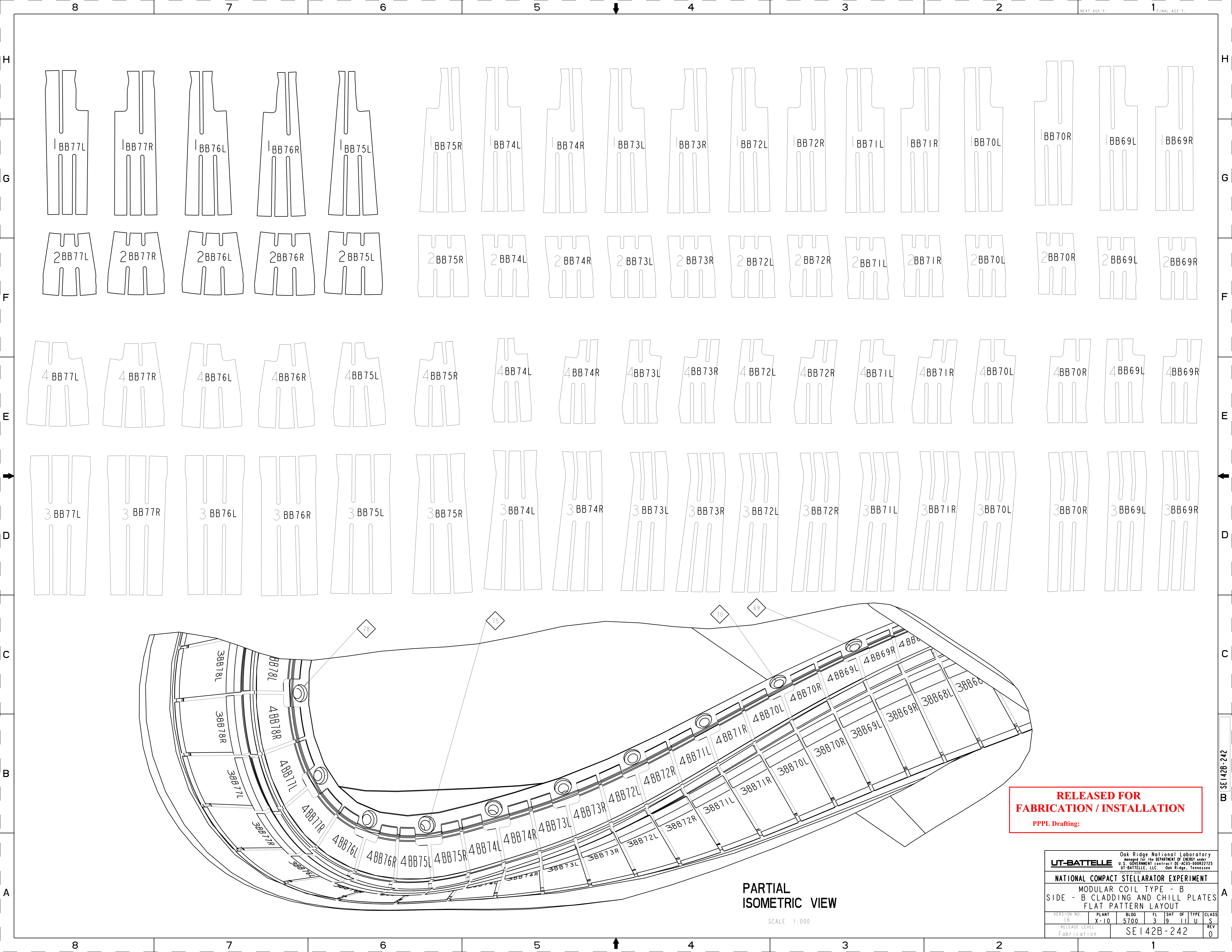

**RELEASED FOR  
FABRICATION / INSTALLATION**

PPPL Drafting:

**PARTIAL  
ISOMETRIC VIEW**  
SCALE 1:1000

UT-BATTELLE		Oak Ridge National Laboratory managed for the DEPARTMENT OF ENERGY under U.S. GOVERNMENT contract DE-AC05-00OR22725 UT-BATTELLE, LLC. Oak Ridge, Tennessee	
PROJECT NAME			
NATIONAL COMPACT STELLARATOR EXPERIMENT			
MODULAR COIL TYPE - B			
SIDE - B CLADDING AND CHILL PLATES			
FLAT PATTERN LAYOUT			
VERSION NO. 16	PLANT X-10	BLDG 5700	FL SHT OF TYPE CLASS 3 9 11 U S
RELEASE LEVEL Fabrication		SE 142B-242	
			REV 0

8

7

6

5

4

3

2

1

NEXT ASS'Y: 1 FINAL ASS'Y:

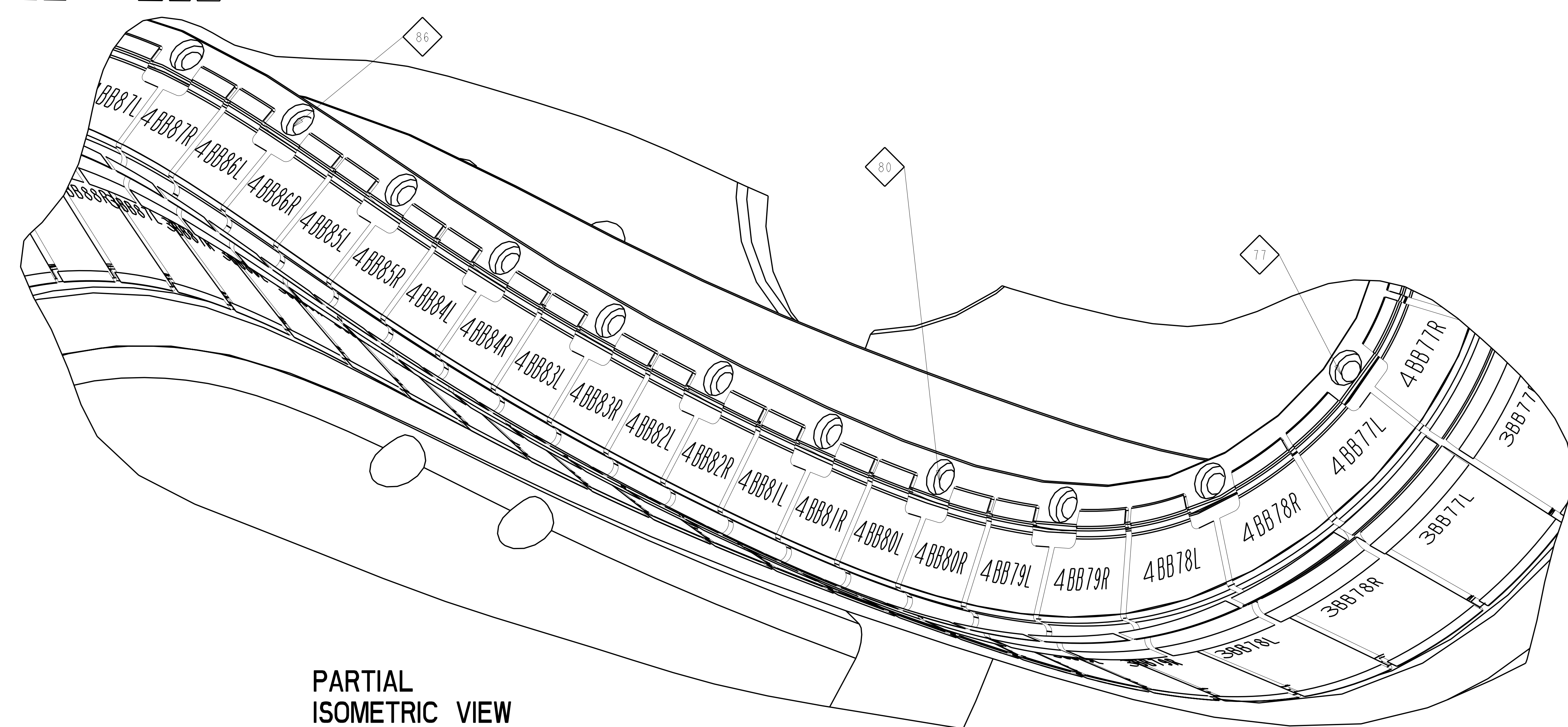
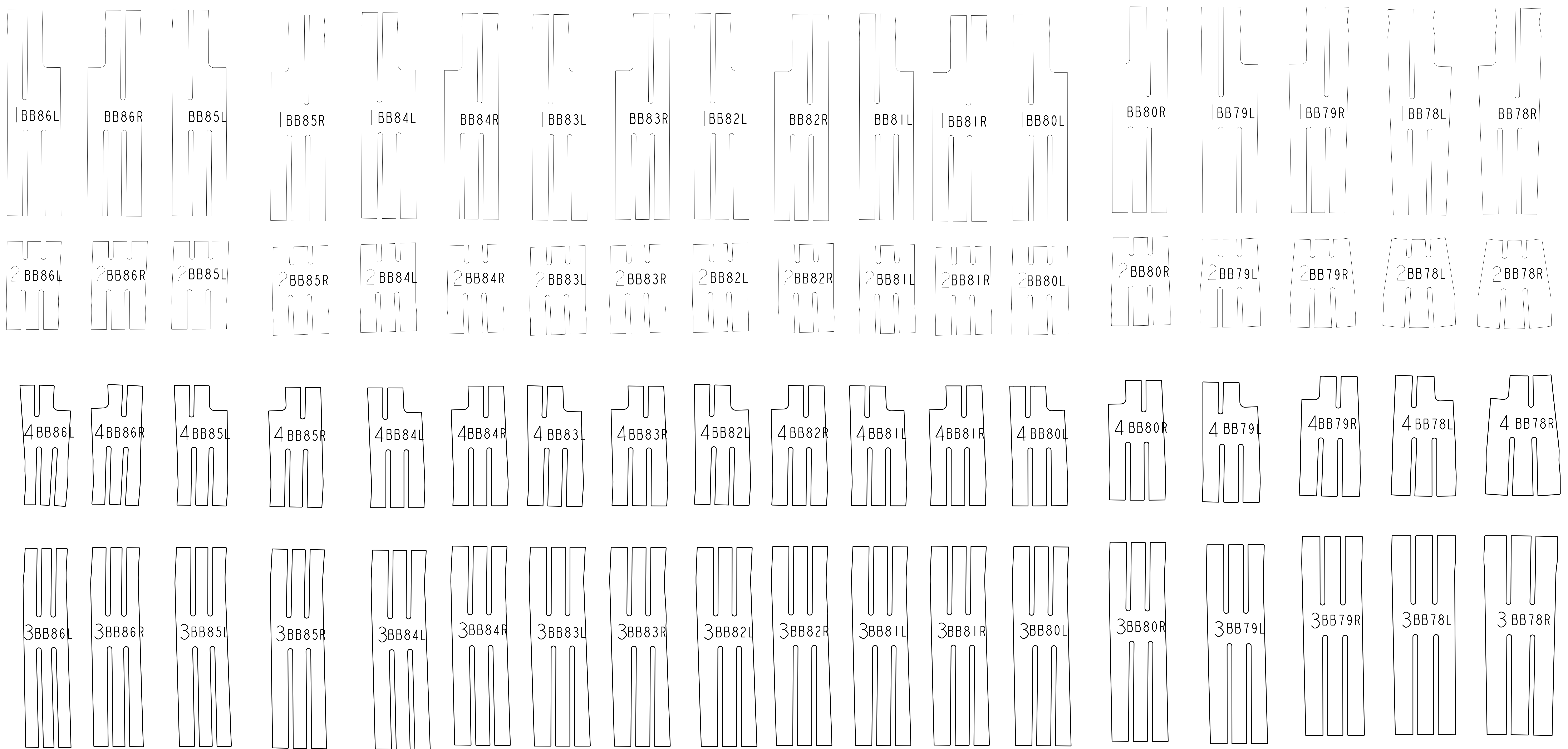

**PARTIAL ISOMETRIC VIEW**  
SCALE 1.00

**RELEASED FOR FABRICATION / INSTALLATION**  
PPPL Drafting:

Oak Ridge National Laboratory managed for the DEPARTMENT OF ENERGY under U.S. GOVERNMENT contract DE-AC05-00OR22725 UT-BATTELLE, LLC, Oak Ridge, Tennessee PROJECT NAME:							
<b>NATIONAL COMPACT STELLARATOR EXPERIMENT</b>							
MODULAR COIL TYPE - B SIDE - B CLADDING AND CHILL PLATES FLAT PATTERN LAYOUT							
VERSION NO:	PLANT	BLDG	FL	SHT	OF	TYPE	CLASS
16	X-10	5700	3	10	11	U	S
RELEASE LEVEL		SE 142B-242		REV		0	
Fabrication							

8

7

6

5

4

3

2

1

242-024135

A

8

7

6

5

4

3

2

1

NEXT ASS'Y: 1 FINAL ASS'Y:

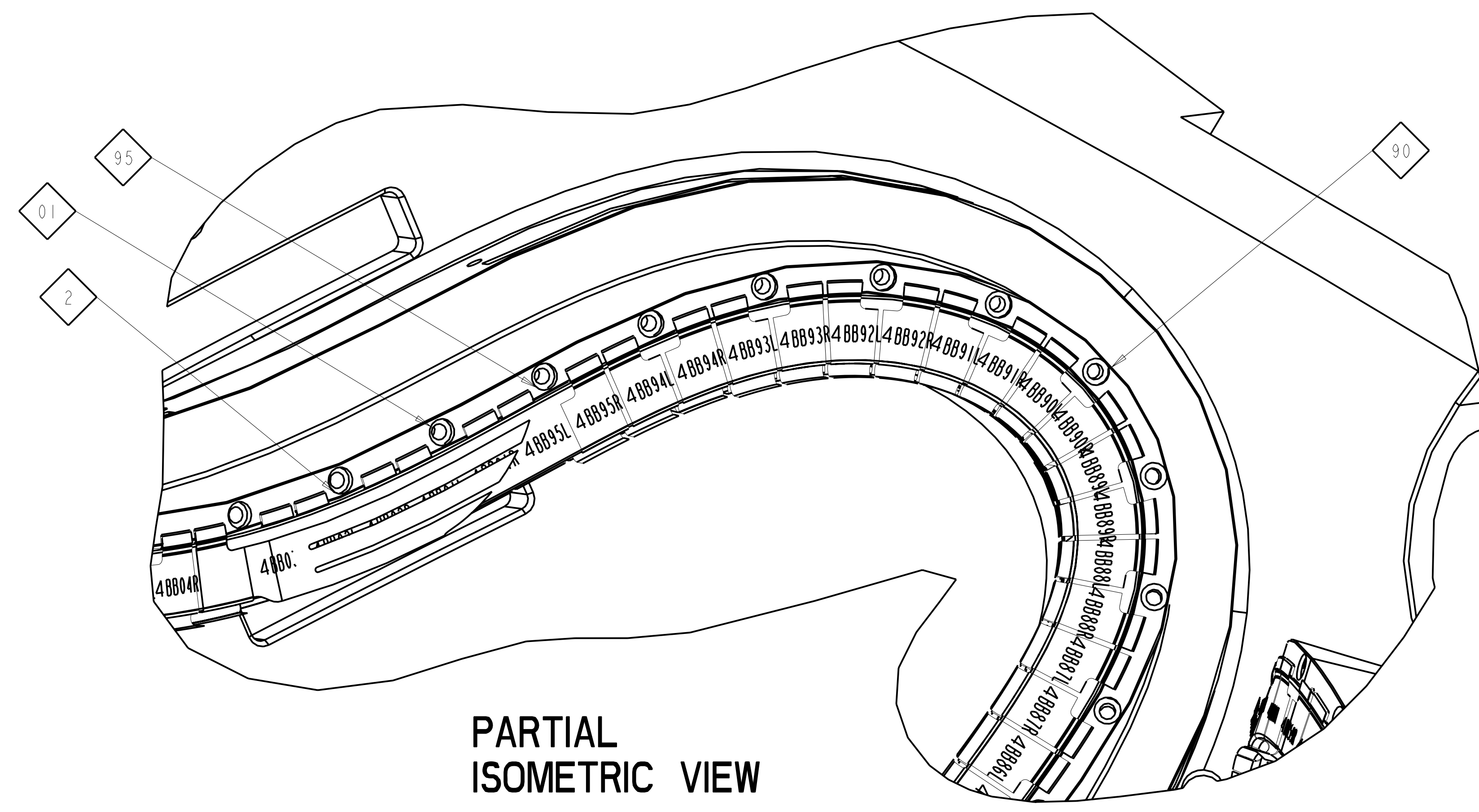
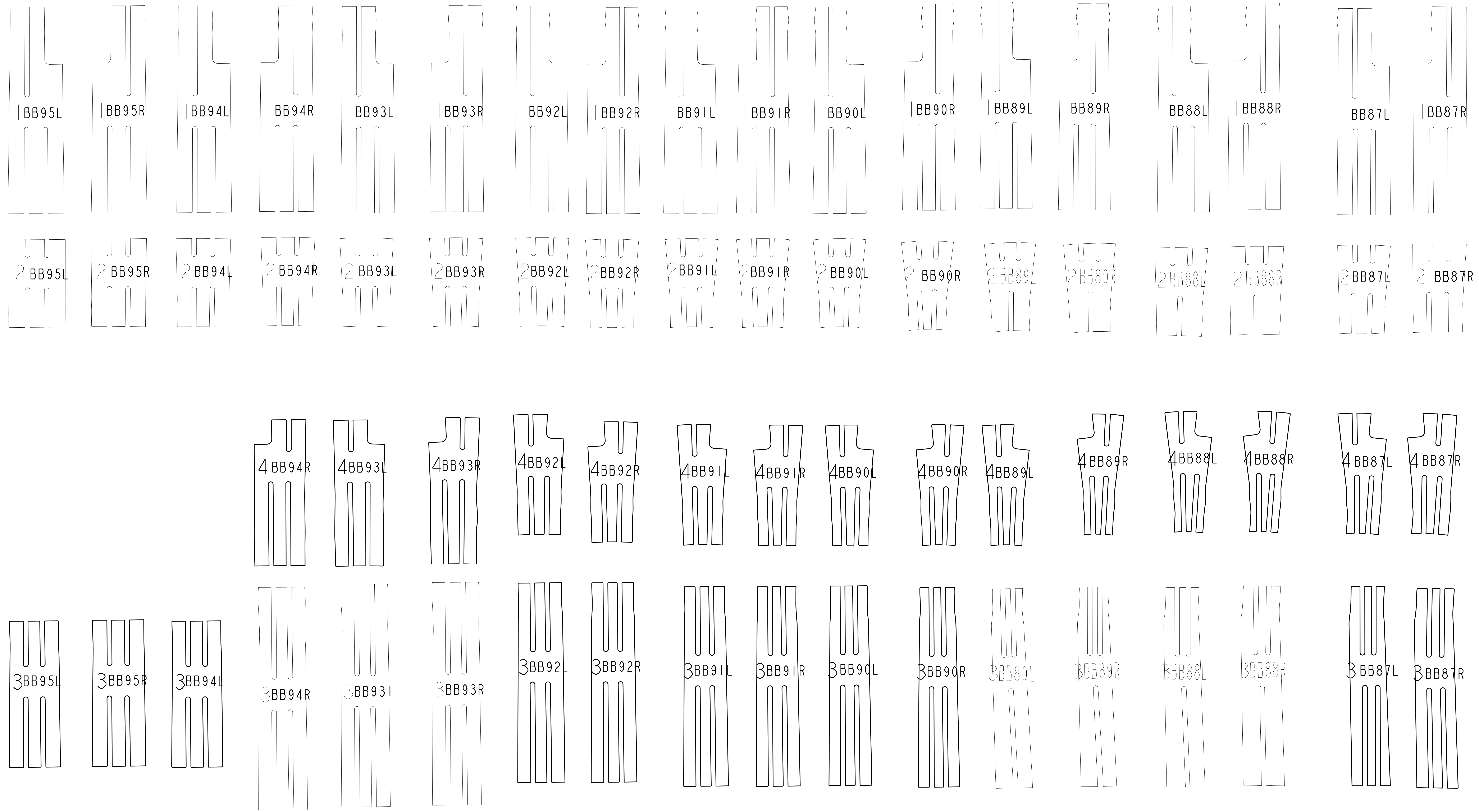

PARTIAL ISOMETRIC VIEW

SCALE 0.50

**RELEASED FOR  
FABRICATION / INSTALLATION**

PPPL Drafting:

Oak Ridge National Laboratory managed for the DEPARTMENT OF ENERGY under U.S. GOVERNMENT contract DE-AC05-00OR22725 UT-BATTELLE, LLC. Oak Ridge, Tennessee PROJECT NAME:							
<b>NATIONAL COMPACT STELLARATOR EXPERIMENT</b> MODULAR COIL TYPE - B SIDE - B CLADDING AND CHILL PLATES FLAT PATTERN LAYOUT							
VERSION NO:	PLANT	BLDG	FL	SHT	OF	TYPE	CLASS
16	X-10	5700	3	1	1	U	S
RELEASE LEVEL		SE 142B-242		REV			
Fabrication				0			

8

7

6

5

4

3

2

1

242-0242-35

A