

# NCSX

## Port 4 Weld Stress During Bake-out

NCSX-CALC-12-006-00\_dA

21 September 2004

**Prepared by:**

---

K Freudenberg, ORNL Engineer

*I have reviewed this calculation and, to my professional satisfaction, it is properly performed and correct. I concur with analysis methodology and inputs and with the reasonableness of the results and their interpretation.*

**Reviewed by:**

---

P. L. Goranson, ORNL Engineer

Controlled Document

**THIS IS AN UNCONTROLLED DOCUMENT ONCE PRINTED.**

Check the NCSX Engineering Web prior to use to assure that this document is current.

## **Introduction**

The Vacuum Vessel (VV) flanges are 304 stainless steel and the port extension pipes are Inconel 625. The thermal design basis stipulates that the flanges and VV be maintained at a minimum of 20 C during standby and operation and the flanges not exceed 150 C during bake out of the VV. This is to avoid excessive stress in the weld joints joining the flanges to the port extensions, due to mismatch in the coefficient of thermal expansion. Analyses were performed using ANSYS to determine the stress in the large non-circular Port 4 during bakeout. The stress was found to be acceptable, but no fault conditions were studied. A criteria was established that the Port 4 weld would never be permitted to see an excursion in temperature exceeding 150 degrees Kelvin, in other words it would never exceed 150 C or fall below 163 K (referred to as the critical temperature in the graphs).

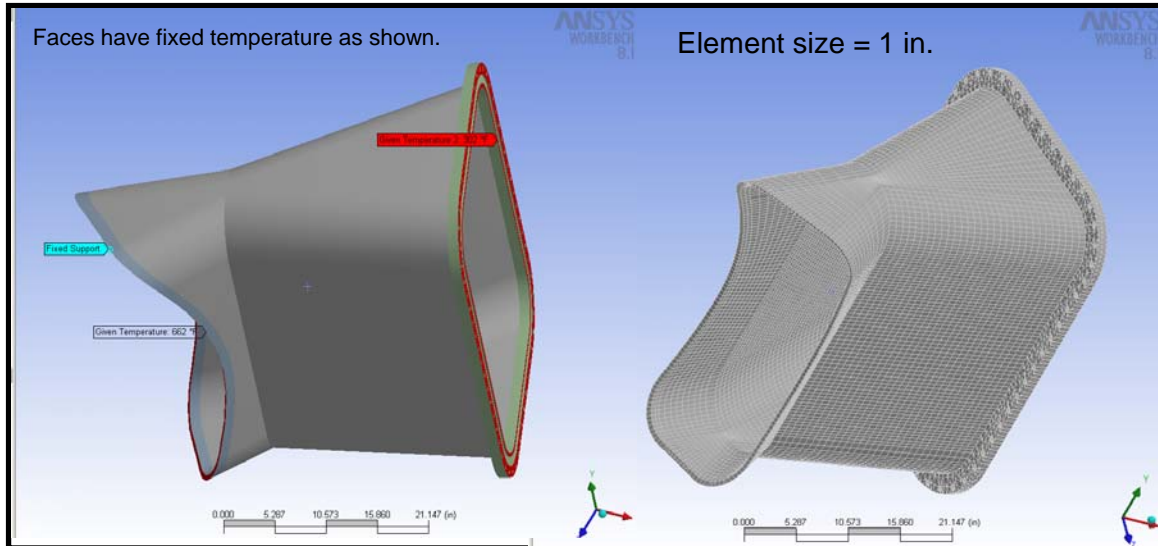
## **Performance Requirements and Criteria**

The NCSX VV Systems Requirements Document, NCSX-BSPEC-12-00 requires that:

- The vacuum vessel and interior components must be baked at 350 C and maintained at a minimum of 20 C before and after operational shots.
- During bakeout, the port extensions are to be maintained at 150 C at the flanges ends and 350 C at vessel end, with gradient between.
- The cryostat and modular coils are maintained at 80 K during both bakeout and standby operation.

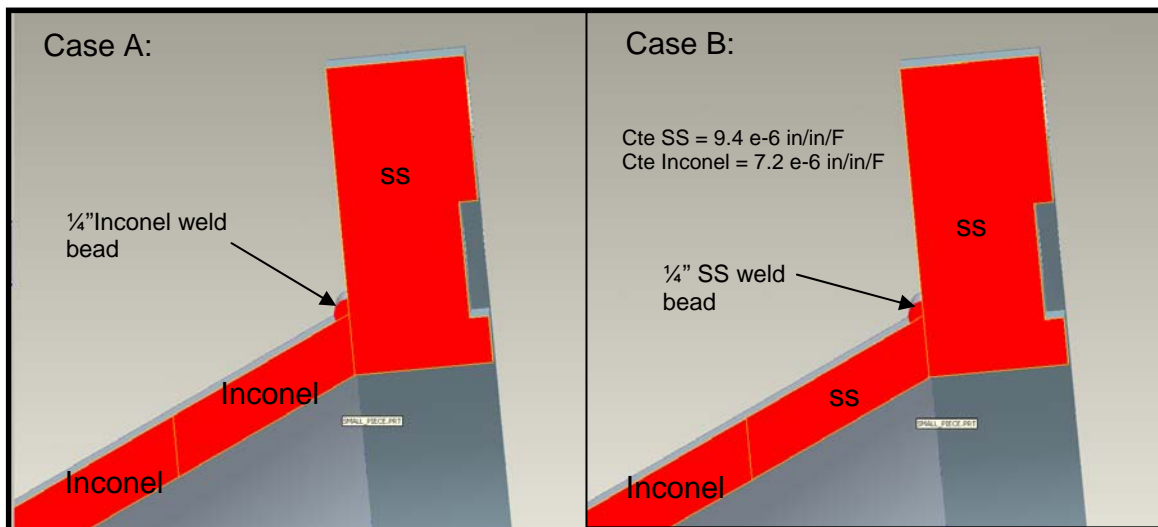
## Methodology

Port 4 was modeled in Ansys and appropriate temperature boundaries are applied. A temperature of 350 C (662 F) is imposed on the vessel interface and a temperature of 150 C (302 F) is applied to the flange side. Two configurations are studied involving the interface between the stainless steel flange and the Inconel port. The mesh of the port consists of 8-node brick elements and the flange is modeled with 10-node tetrahedral elements, both have a 1 in. element size.



**Figure 1: Model and mesh**

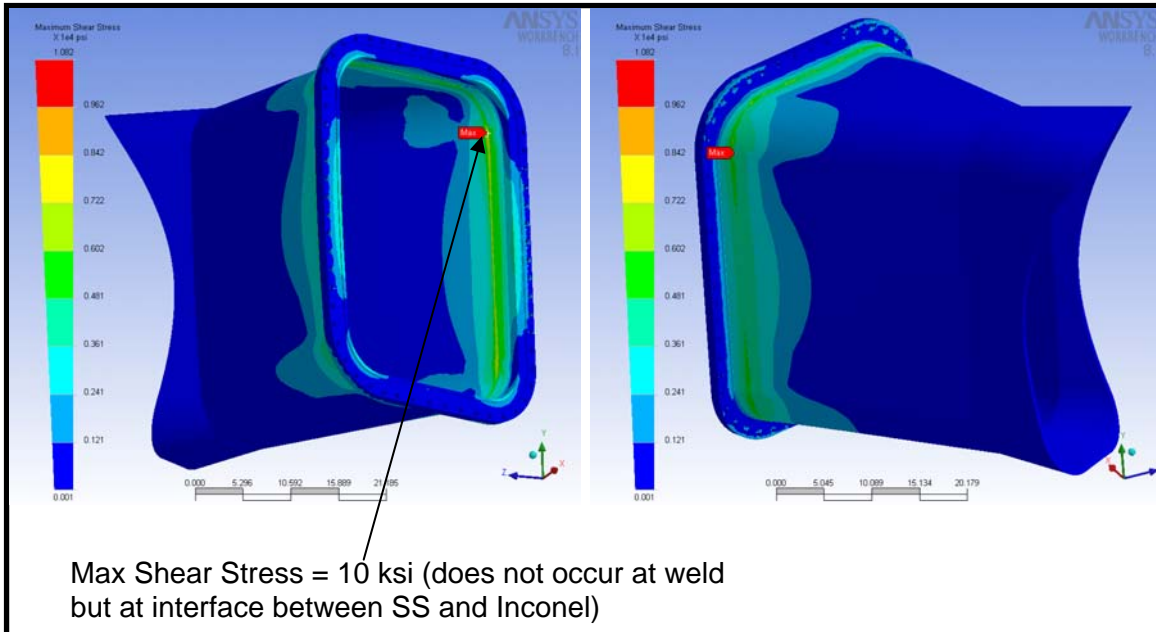
Two configurations are studied to determine the impact of buffering the connection with a stainless steel stub, shown below on the right in Figure 2. Case A, as indicated below, is the current design scenario and case B is studied only as a plausible alternative.



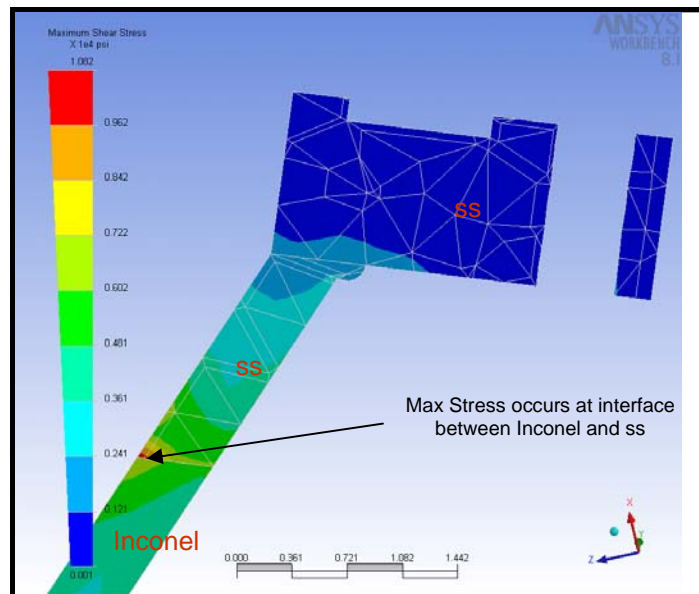
**Figure 2: Two configurations, with and without stainless steel stub.**

## Results

The shear stress for both flange configurations is plotted below. Figures 3 and 4 indicate that the maximum shear stress does not occur at the weld but instead occurs at the interface of the stainless steel stub and the Inconel port. The maximum shear stress for case B is 10 ksi.

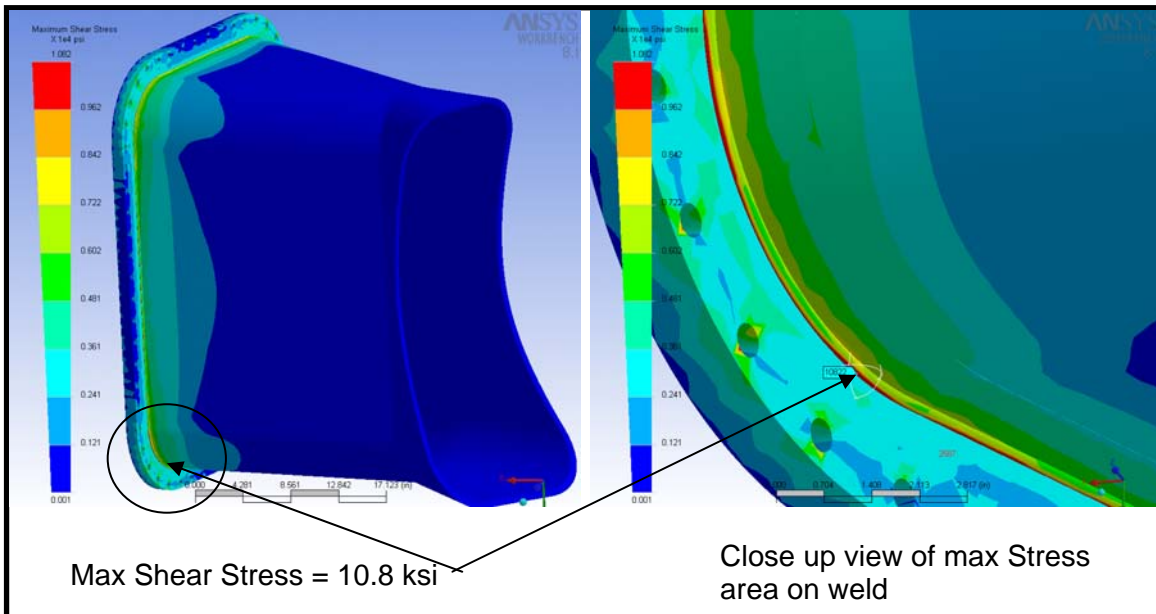


**Figure 3: Max shear stress with stainless stub in place (Case B).**

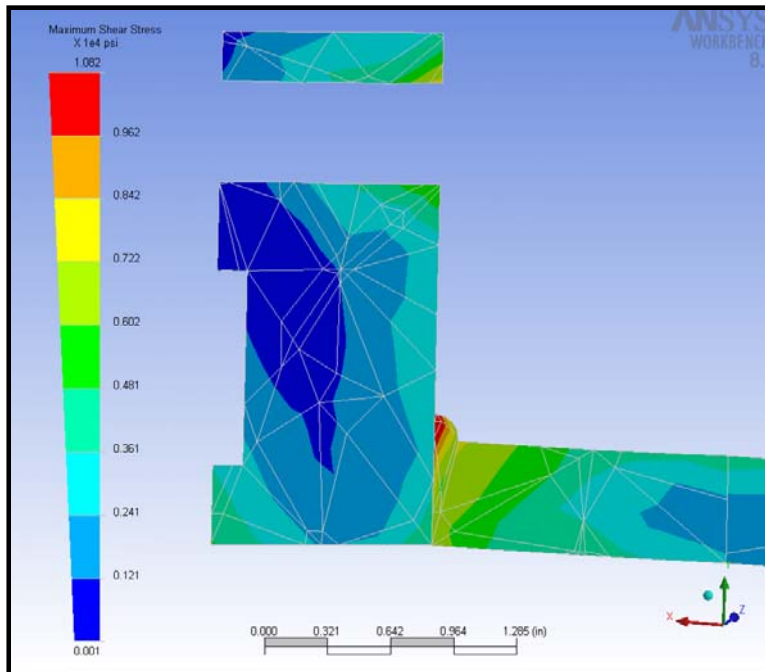


**Figure 4: Shear stress with stainless stub in place. (Case B)**

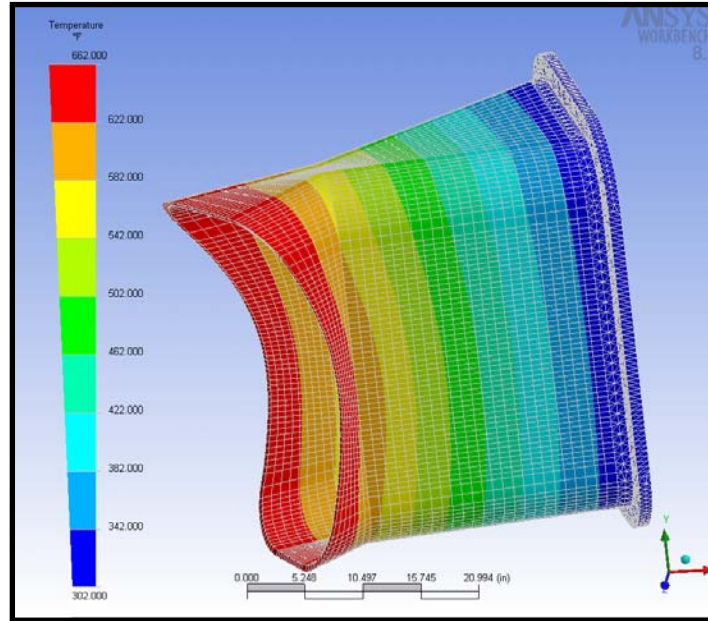
Figures 5 and 6 indicate that the max shear stress occurs at the weld interface between the flange and the Inconel port for the case with the weld stub removed. The maximum value is 10.8 ksi. This value of stress is within the



**Figure 5: Shear stress where the Inconel port connects directly to the flange (no SS Stub, Case A).**



**Figure 6: Shear stress cross section near the max stress location (Case A).**



**Figure 7: Temperature Distribution through the port and flange.**

The Magnitude of the max Shear stress (10.2-10.8 ksi) appears to be independent of whether the SS stub is present or not. The location of the max stress is, of course, dependent on whether the stub is in place.

Both cases have stress levels that are under the AWS specification of 13.6 ksi for carbon steel. However, the current design scenario (no stainless stub) uses Inconel as the weld material and thus provides a slightly better design as Inconel has a higher strength rating than the AWS specification.

### **Conclusions:**

The stresses are low and it is probable that the flange welds can safely survive an excursion to the imposed temperature gradient. The AWS allowable for carbon steel static weld stress is 13600 psi. This takes into account residual stress due to welding. Using the carbon AWS Carbon rating as a basis is conservative as the allowable strength for an Inconel weld is higher. Thus, the current design (case A in this report) where the Inconel port is welded directly against the stainless steel flange is the design method of choice.