

NCSX
Design Basis Analysis

VV Local Thermal Analysis

NCSX-CALC-12-001-01

01 June 2006

Prepared by:

K. Freudenberg, ORNL

I have reviewed this calculation and, to my professional satisfaction, it is properly performed and correct. I concur with analysis methodology and inputs and with the reasonableness of the results and their interpretation.

Reviewed by:

P. Goranson, ORNL Engineer

Controlled Document
THIS IS AN UNCONTROLLED DOCUMENT ONCE PRINTED.
Check the NCSX Engineering Web prior to use to assure that this document is current.

I. Executive Summary

The purpose of this analysis is to examine the heat transfer characteristics of a local model of the vacuum vessel during and after an operational pulse. Each pulse radiates heat to the surface of the vacuum vessel, raising its temperature. The heat is subsequently dissipated by cooling tubes attached to the outer surface of the vessel mechanically by a clamp configuration and Grafoil gaskets. This local analysis proves that there is a regime where both tube spacing and the temperature of the cooling fluid (in this case Helium) are sufficient to meet the required cooling temperature and thermal stress criteria. Further, this analysis is not intended as a review of the clamping configuration. The mechanisms behind the design of clamp (i.e. whether springs or Belleville washers will be required to compensate for Grafoil compression?) are outside of the scope of this report.

II. Assumptions

- All material properties are constant. (evaluated at room temperature)
- The Surface of the outer Grafoil pads is fixed at a constant temperature. (The helium thermal hydraulics will be the subject of DAC-CALC-12-002-00 by Goranson, and is assumed to be adequate to produce a constant temperature boundary condition in the tubes.) However, this analysis does also briefly compare the use of a local convection coefficient (over a wide range) to the constant surface temperature constraint.
- Heat from the pulse is imposed as a uniform heat flux (12 MW for 1.2 sec) applied to the Inconel (vessel shell) on the opposite side from the cooling pads.
- Heat loss to the cryostat is considered by applying a negative heat generation term over the Inconel (vessel shell) volume.
- Radiation exchange with other surroundings is negligible.
- Steady state conditions are used to evaluate the stress distribution at the largest temperature gradient profile.

III. Analysis Methodology and Inputs

For this study, the maximum allowable steady state temperature in the vessel is 313 K or 40 °C. This corresponds to a maximum steady state delta T of 20 °C. The maximum thermal stress (secondary stress) must be less than three times the maximum stress intensity defined by the ASME B&PV Code (Section III, Division 1. The model is a representative section of the vessel and is not a section of the actual vessel.

Software and data files

The model is constructed in Ansys 7.0 and all of the preprocessing and post processing is done within the Ansys environment.

Drawings and models

No drawings have been referenced in this study. All models have been created as Ansys files. The chosen geometry is a flat plate of Inconel with a cooling tube connection (pad) placed in the middle of the model and four satellite pads placed at each corner of the plate.

Material Properties

Two materials are used in this analysis (Grafoil and Inconel 625). The material properties for Grafoil were obtained from its parent company of the product, Graftech Inc¹. The material properties for Inconel 625 were obtained from the MatWeb online materials database². The material properties for the two materials are shown below in Table 1. Additionally, the yield and ultimate strengths for Inconel 625 are 460 MPa and 880 MPa respectively and the corresponding maximum allowable stress intensity is 252 MPa at 300 K.

Table 1: Material property data

Property	Inconel 625	Grafoil
Density (kg/m ³)	8030	1200
Thermal conductivity, k (W/m-K)	12.1	10
Specific heat, cp (J/kg-K)	418	711
Modulus (GPa)	208	1.38
Cte (cm/cm-°C) {Grafoil value is to layers}	0.0000128	4.00E-07
Poissons ratio	0.28	0.3

Model Setup

The first model used in this analysis is shown below in Figure 1. It is a 3d representation of a section of the vacuum vessel and consists of a flat piece of the vacuum vessel material (Inconel 625) and five attached Grafoil cooling pads. The outer grafoil pads are ¼ representations of the center pad. This is due to the symmetry of the model in which the minimum amount of material was modeled to arrive at the heat transfer configuration. The model could have been further broken down into quarter symmetry by modeling only two pads. But, using a five pad model was easier to error check the heat distribution pattern and the processing time for the larger redundant model was not significant. The attachment points (pads) are separated in a somewhat “checkerboard-like” pattern where the horizontal distance between pads is four inches and the vertical spacing is ten inches. Additionally, both the horizontal and vertical clamp spacing were varied to determine their affect on temperature and stress values.

¹ Graftech, Inc., Cleveland, Ohio, Technical Bulletin Number 208, Revised September 18, 2000.

² MatWeb online database, properties from Special Metals, Inc., Publication SMC-027 Oct. 2003.

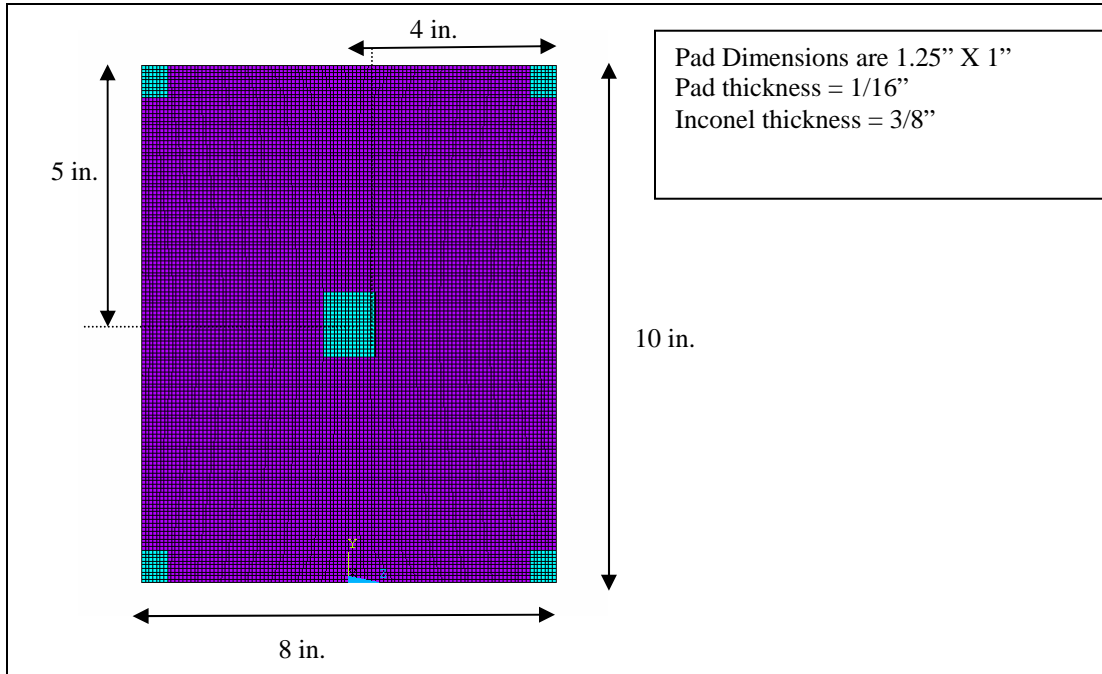

Figure 1: Sketch of the Ansys Model (model I).

The model has been meshed with Solid 45 elements for the structural analysis and Solid 70 elements for the thermal analysis. The mesh consists of five elements through the thickness of the Inconel using a length of 0.075 in and two elements through the thickness of the grafoil pad with a length of 0.03125 in. A detailed view of the element configuration is shown in Figure 2.

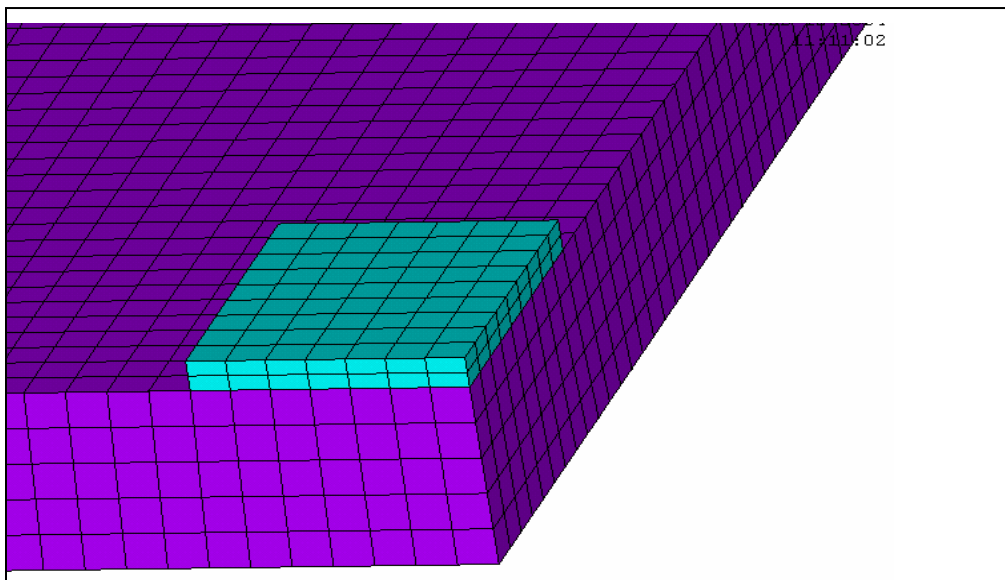

Figure 2: Elements through the thickness of the two materials.

A second Ansys schematic (model II) detailing a basic representation of one cooling tube fixture is shown in Figure 3. This model is necessary in order to address the question of whether the gradient through the thickness of the Grafoil is an issue. The Grafoil pad is well suited for applications that do not involve large temperature gradients through its thickness. Thus, gradients of more than a few degrees are not acceptable in the current design.

The cooling tubes are mounted on top of the pad. The purple geometry represents the Inconel cooling tubes and the red geometry is a copper fixture which connects the Inconel tubes to the cyan Grafoil gasket. The clamping mechanism used to affix the tubes to the Grafoil pads and the Inconel vacuum vessel is not drawn or a part of this analysis. The Grafoil pad, copper and Inconel are all assumed to be in good contact for the purposes of this report. Also, the base of the model, representing the vacuum vessel surface, is diagonal in shape in order to approximate the checkerboard symmetry of the cooling pads without modeling multiple pads and tubes.

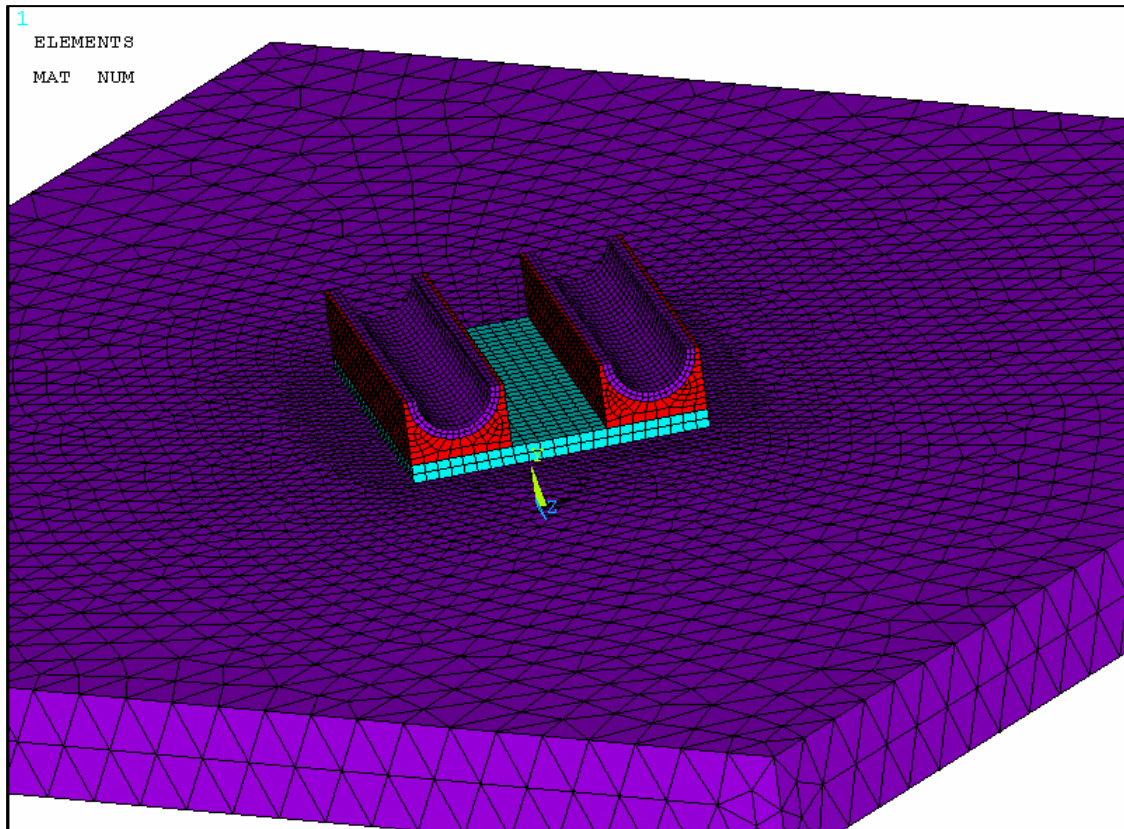

Figure 3: Ansys schematic used to determine the temperature gradient through the Grafoil pad (model II).

Thermal Analysis Setup

A transient thermal analysis is performed on the Inconel/Grafoil model I. Initially, all components are fixed at 294 K. The heat from the operational pulse is imposed as a surface heat flux (36.8 W/cm^2) which is applied to the back of the plate for 1.2 sec. Using a heat flux produces a temperature gradient through the Inconel thickness that would otherwise not be present if a volumetric heat load were used. This represents both the highest total heat load to the vessel (12 MW) and the longest planned pulse and corresponds to a 13 K rise in bulk temperature. Cooling to the cryostat is also considered and is applied to the vessel as a negative volumetric heat generation term ($g = -12,200 \text{ W/m}^3$) throughout the analysis, which corresponds to a value of 116 W/m^2 . Using a fixed heat removal rate is conservative since this rate will go up as the temperature in the vessel rises. Both heat generation rates and flux values are documented in DAC-CALC-12-002-00 by Paul Goranson.

Finally, the cooling tubes are idealized as fixed temperature pads. The temperature on the top of the pads is held at 294 K (room temp) during operation. After the initial pulse, the model is allowed to cool for 15 minutes by means of the cooling pads and the heat loss to the cryostat. This cycle of pulse/cooldown is repeated ten times for a total of 150 minutes to check the affect of ratcheting temperatures in the vessel.

The second model, shown in Figure 3, is set up in the same manor as first except that instead of a constant temperature being applied to the Grafoil pad area, it is now applied on the inner areas of the Inconel tubing. All other parameters remain the same as identified in the paragraphs above. Additionally, a convective boundary condition was imposed on the inner areas of the Inconel tubing, replacing the constant temperature approximation in subsequent runs. The use of the convective boundary condition is intended to provide a limiting value on the convective film coefficient (h) for which the constant temperature approximation is valid.

Structural Analysis Setup

The structural analysis portion of the study uses the temperature nodal values (at $t = 8101.2$ seconds) from the thermal analysis as the loading condition. This situation corresponds to both the largest gradient through the thickness of the Inconel and the largest gradient across the model as the temperature cool down distribution approaches steady state. The model is constrained on all sides by symmetry boundary conditions which mean that out-of-plane translations and in-plane rotations are set to zero. The constraint set is completed by fixing one corner node in all directions.

IV. Results

The temperature distribution after the initial pulse is shown below in Figure 4. This temperature plot illustrates the gradient through the thickness of the Inconel vessel immediately after the pulse. The maximum temperature at 1.2 sec is 351.7 K. All temperature plots are expressed in units of degrees Kelvin. The plots shown are for a ten inch vertical spacing with a four inch staggered horizontal clamp spacing configuration.

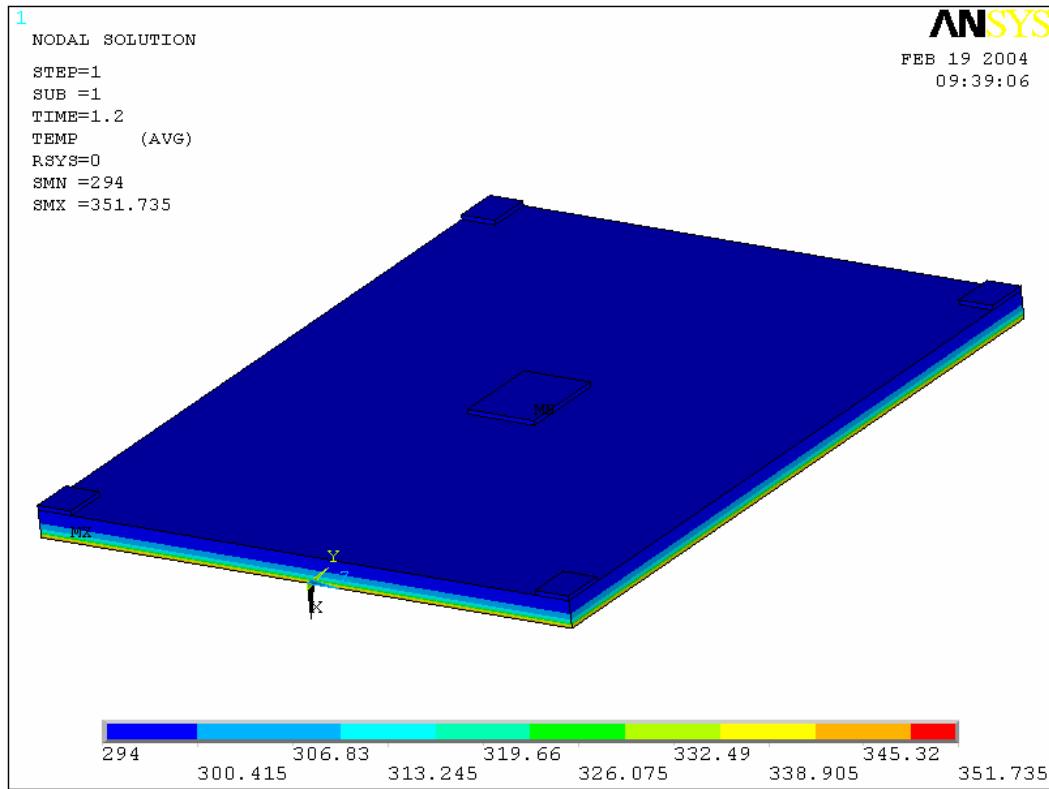

Figure 4: Temperature distribution after the first pulse (t = 1.2 sec)

The temperature distribution after the first 15 minute cool down and the last cool down period (t = 9000 sec) are shown below in Figures 5 and 6 respectively.

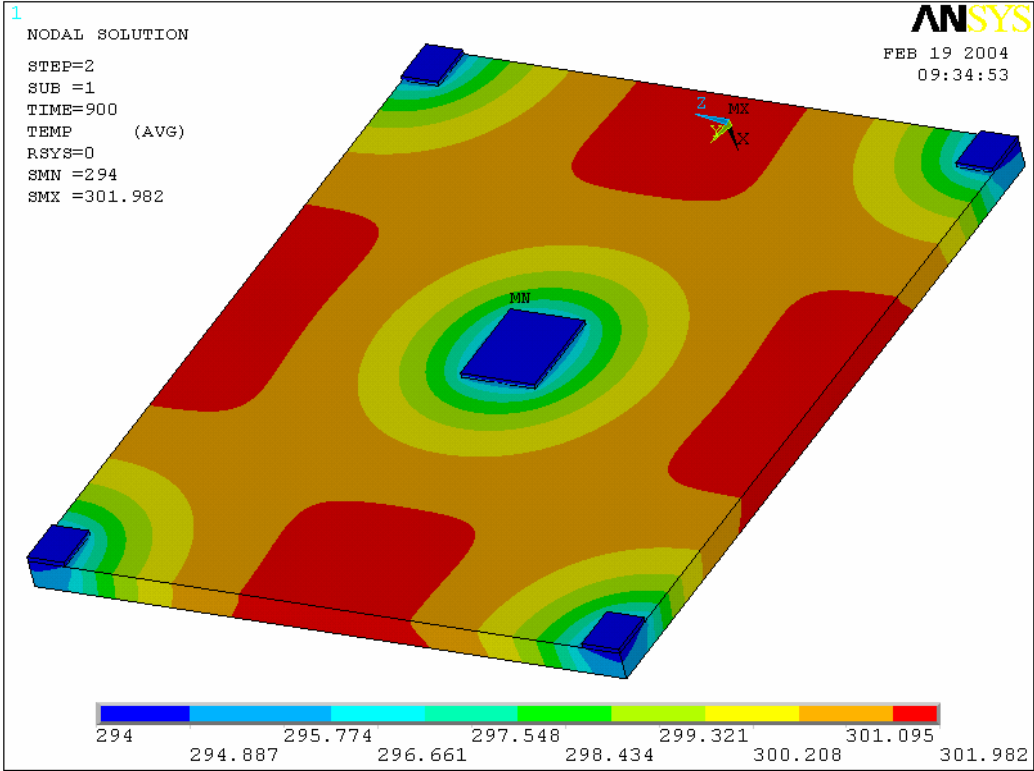

Figure 5: Temperature distribution after the first cool down period ($t = 15$ mins)

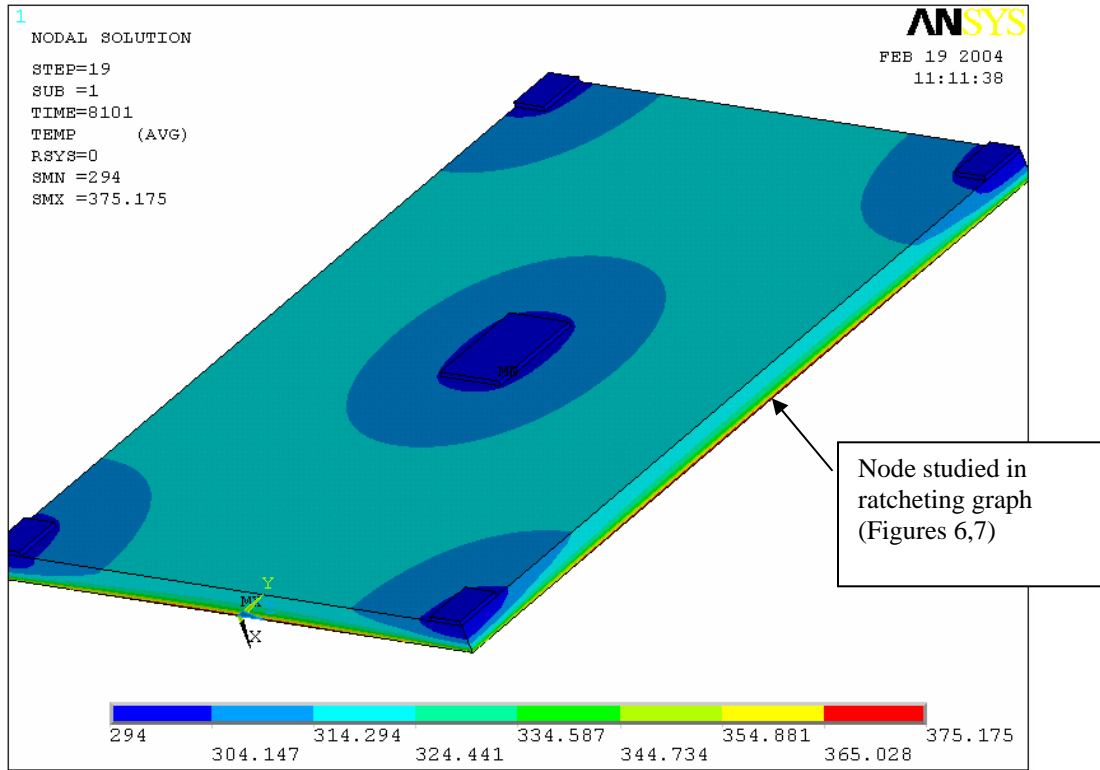

Figure 6: Temperature distribution after the last pulse ($t = 8101.2$ seconds)

The ratcheting temperature distribution of a node in the “hot zone” located on the bottom of the Inconel plate (shown above in Figure 5) has also been investigated and is shown in Figure 7. The nodal temperature approaches a steady state solution after the fifth or sixth cycle. The steady state temperature levels off to around 317 K which is higher than the imposed 40 C requirement.

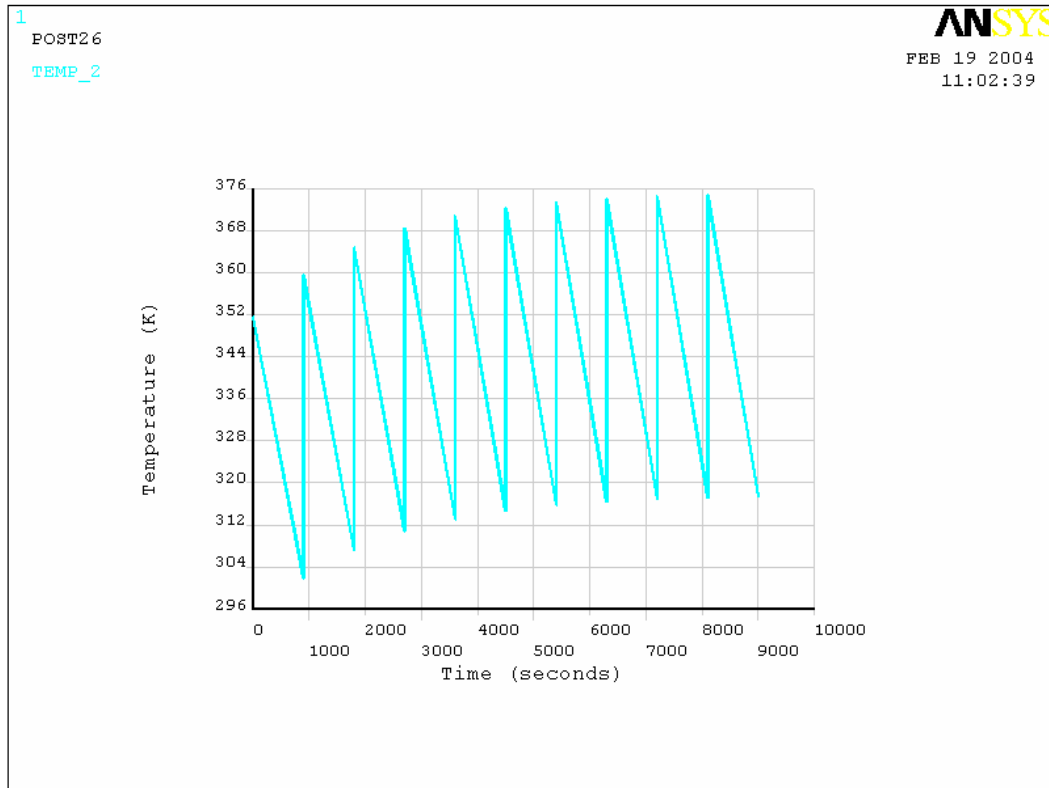

Figure 7: Ratcheting node temperature distribution with applied surface heat flux.

Temperature Variations through Multiple Studies

The above plots illustrate the temperature contour distributions for one specific case of the many performed. However, the contours patterns are similar for all models with the relative contour values changing depending on the parameters being considered. These parameters include both the vertical and horizontal tube spacing, helium bulk temperature and cool down time. The horizontal tube spacing was varied from a maximum of eight inches to a minimum of four inches. The eight inches is what is currently requested by the design and decreasing to four inches would add more tubing and elevate cost. The vertical spacing was also varied, ranging from constant contact at zero spacing to maximum ten inch spacing. The zero spacing case is indicative of a welding configuration were the tubes are constantly in contact with the vessel. Welding presents its own set of problems as the vendor would must likely be required to complete this task whereas the Grafoil clamping pad system could be installed after the vessel had been delivered. The cool down time was initially considered at 15 minutes but was doubled to 30 minutes in order to determine its affect on thermal gradient outcome. Finally, the bulk He temperature was evaluated at both

room temperature and at a chilled temperature of 0 °C. Refrigerating the He would require additional cooling equipment not currently under consideration.

The effect that each of these parameter has on the overall system is shown in Figure 8 where steady state temperature is plotted as a function of vertical tube spacing. The default model (pink line with block squares) for which compassion can be made has, eight inch horizontal spacing, He at room temperature and a cool down time of 15 minutes.

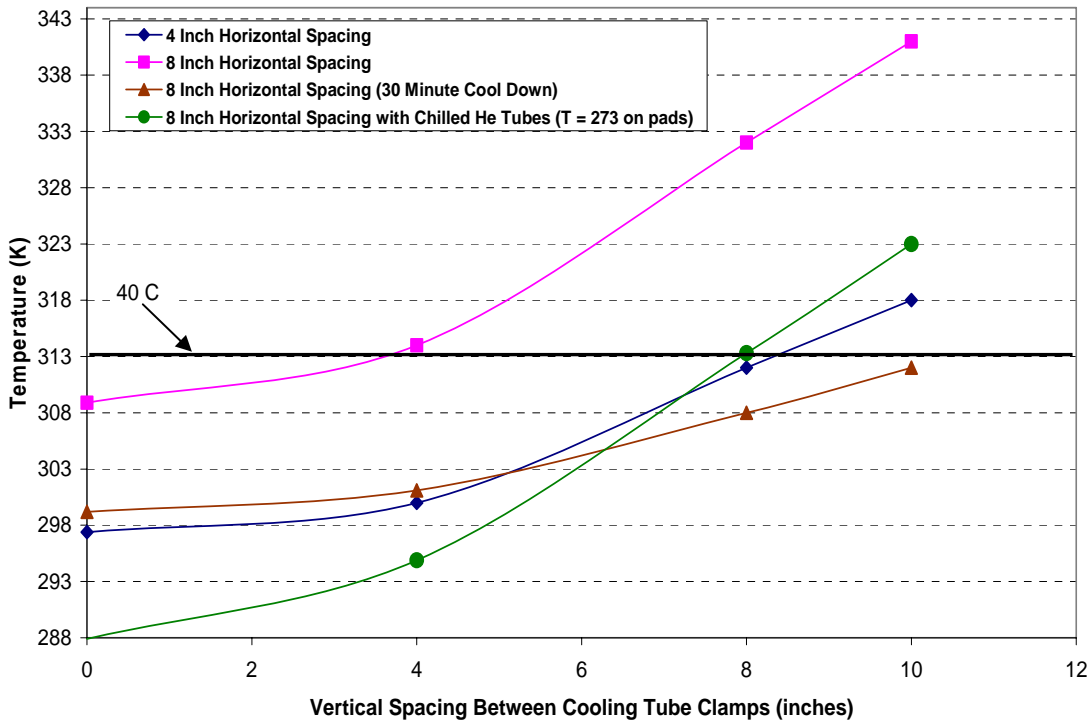

Figure 8: Steady state temperature as a function of clamp spacing (15 Minute Cool Down)

Gradient through the Grafoil Pad.

Figure 9 shows the temperature through the Grafoil pad after cool down (t = 15 mins) where the scale is measured in increments of 0.2 degrees. A section view through the middle of the model is shown to illustrate the contour pattern through the Grafoil. Figure 10 demonstrates the gradient at the end of a pulse. Temperatures greater than 296.4 are shown in gray in both Figure 9 and 10.

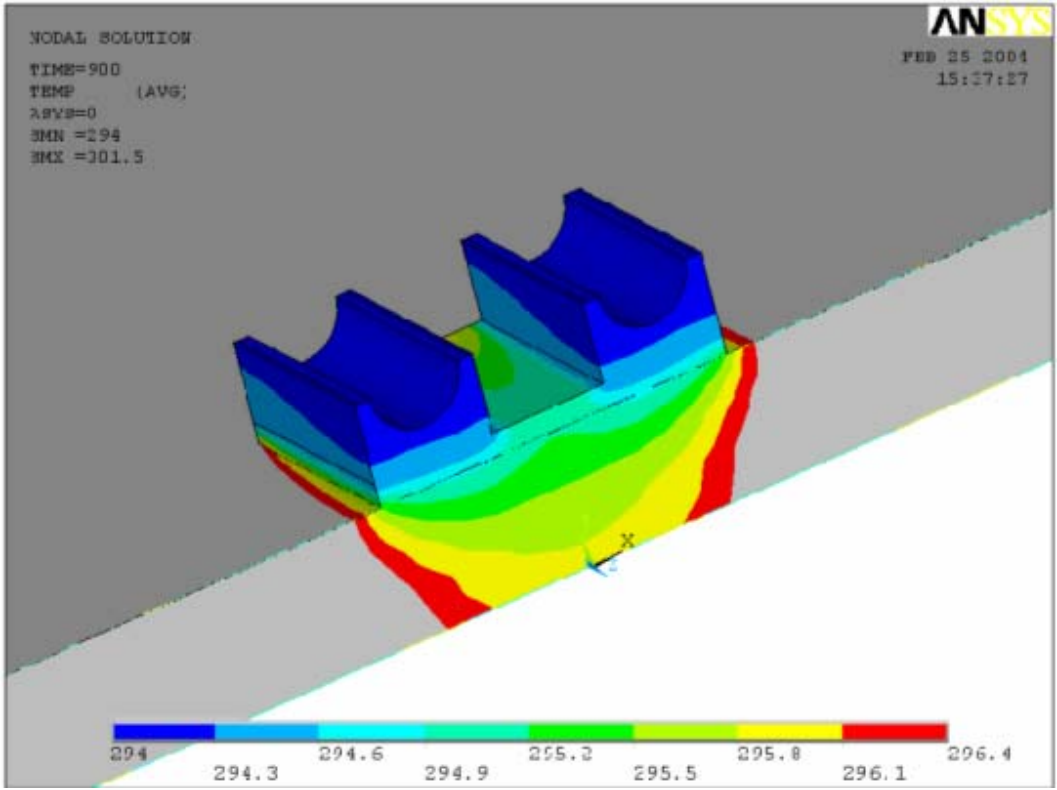

Figure 9: Temperature gradient through the Inconel after cool down (15 Mins)

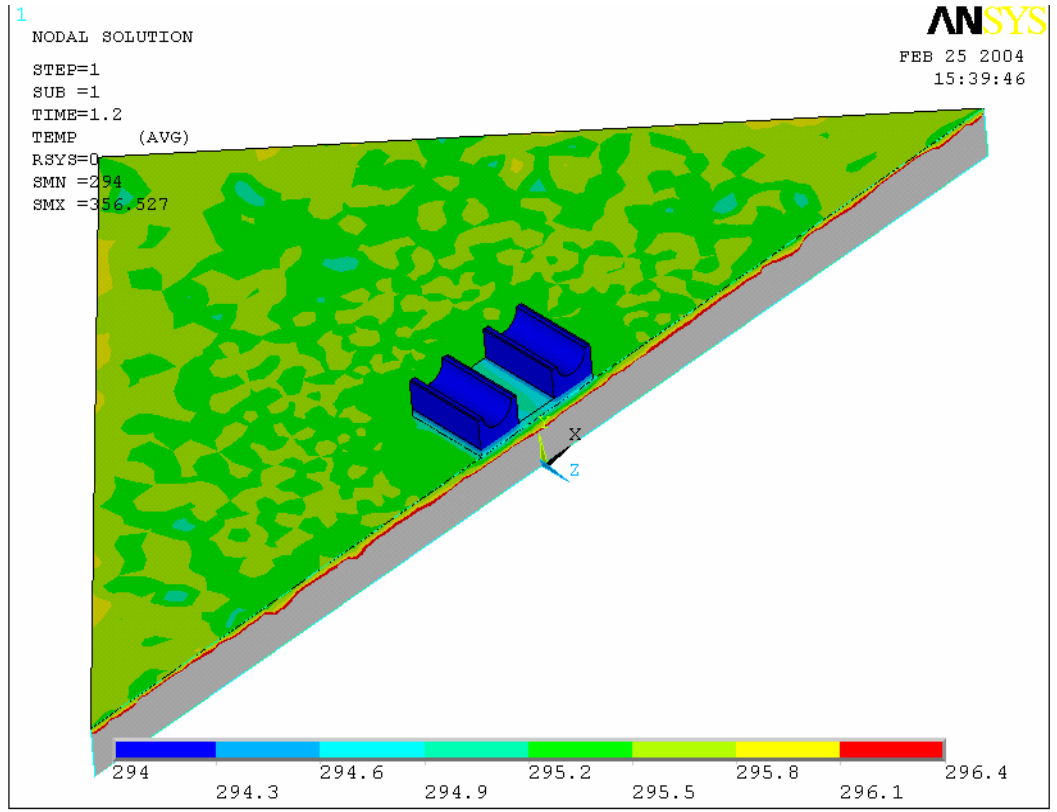

Figure 10: Temperature gradient through the Inconel after pulse (1.2 sec)

The constant surface temperature approximation applied to the Grafoil pad surface has been checked against applying a convection coefficient on the Inconel tube surface in the second model. Figure 11 plots three different film coefficients and their corresponding Inconel tube surface temperatures on a semi log scale. The surface temperature approaches the constant temperature (294 K) as the film coefficient approaches 10,000 W/m²K. Calculations in DAC-CALC_121-02-00 by Goranson place the heat convection value at around 1,000–2,000 W/m²K, which suggests that the approximation of a constant temperature may be undervalued by two degrees. One method to further increase the convection coefficient is to increase the mass flow as is it directly proportional to the heat transfer rate.

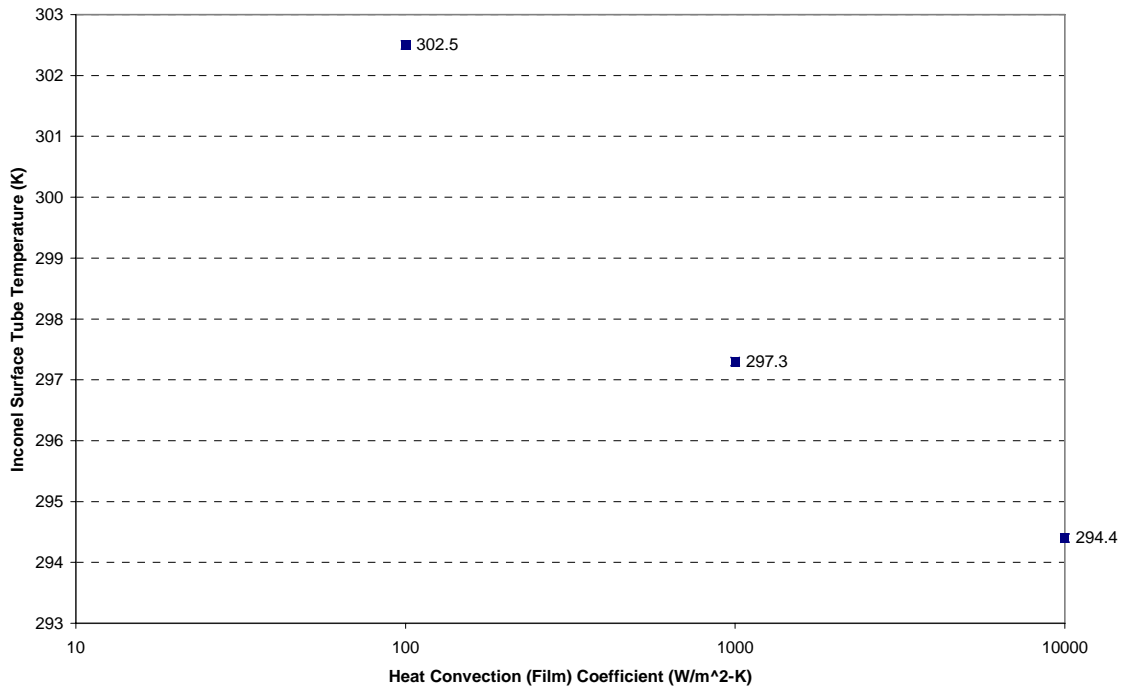

Figure 11: Inconel tube surface temperature as a function of heat convection film coefficients. (Log Scale on X-Axis).

The variation of heat flux for the original design case was also examined. Figure 12 shows that an expected linear relationship exists between the amount of power (surface heat flux) supplied to the system and the steady state temperature. The data points are consistent with the maximum horizontal and vertical spacing clamp (eight and ten inches respectively), that cools for 15 minutes. The minimum temperature value of 278 K (not 294 K) is a direct result of applying the negative heat generation value, representing heat loss to the cryostat, over the volume of the Inconel vessel volume. That is, if the system were to stand without being pulsed by operational heat loading, the temperature of the vessel in some localized spots would reach 278 K and the cooling pads would be effectively heating the system. An important observation here is that the steady state case with no heat flux is independent of any geometric spacing and cool down parameters considered above in Figure 8 (not true for helium gas temperatures). Thus, if a single temperature value from Figure 8 is plotted at X = 1, (max heat flux) and a liner line is drawn

between 278 K and that value, the behavior of that specific geometric or time case could easily be inferred as a function of applied heat load.

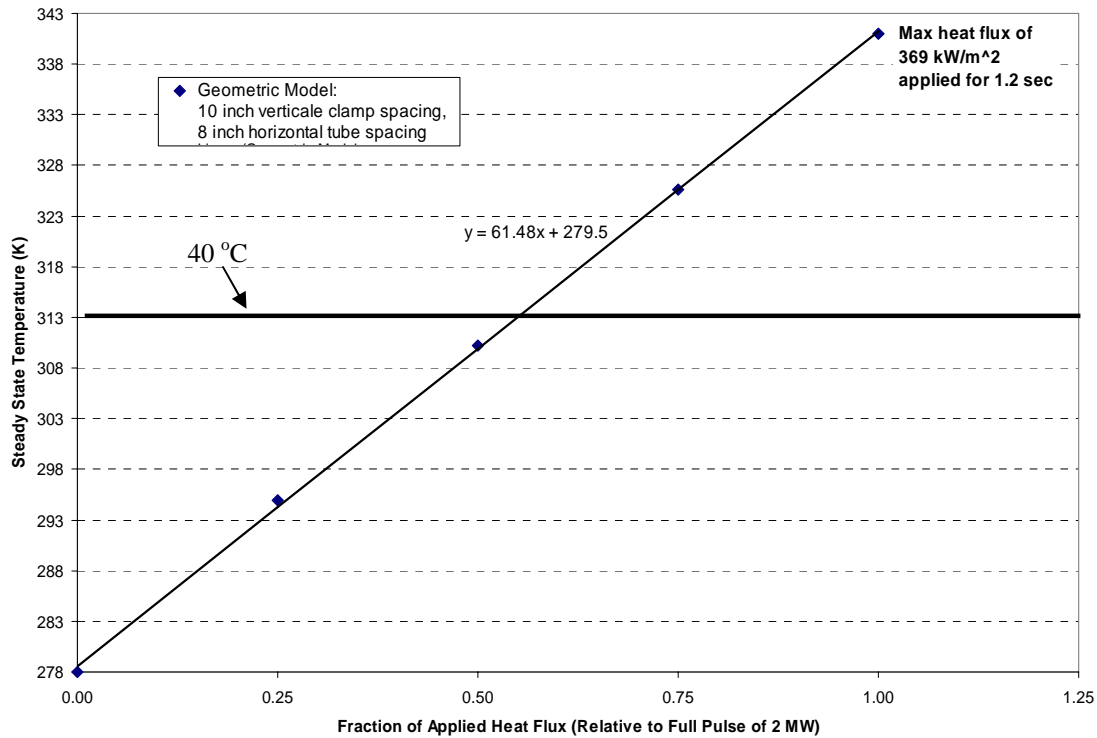

Figure 12: Steady state Vessel temperature as a function of the applied fraction of maximum heat flux. ($q_{max} = 369 \text{ kW/m}^2$)

Stress Distribution

The Von Mises stress distribution is shown in Figure 13 and 14. Figure 13 uses the max temperature gradient through the thickness of the Inconel and the maximum gradient across the model by using the temperature profile from immediately after the last pulse. Figure 14 indicates the stress after the last cool down period ($t = 15$ minutes) and thus does not indicate the degree of thermal stress through the thickness of the Inconel. The max stress reported in Figure 13 (the more severe case) is around 0.269 E9 Pa or $38,000 \text{ psi}$. The max stress in Figure 14 is 0.558 E8 Pa or $8,000 \text{ psi}$. Both Figures 13 and 14 consider stress under the worst case heat loading with ten inch vertical and four inch horizontal tube clamp spacing.

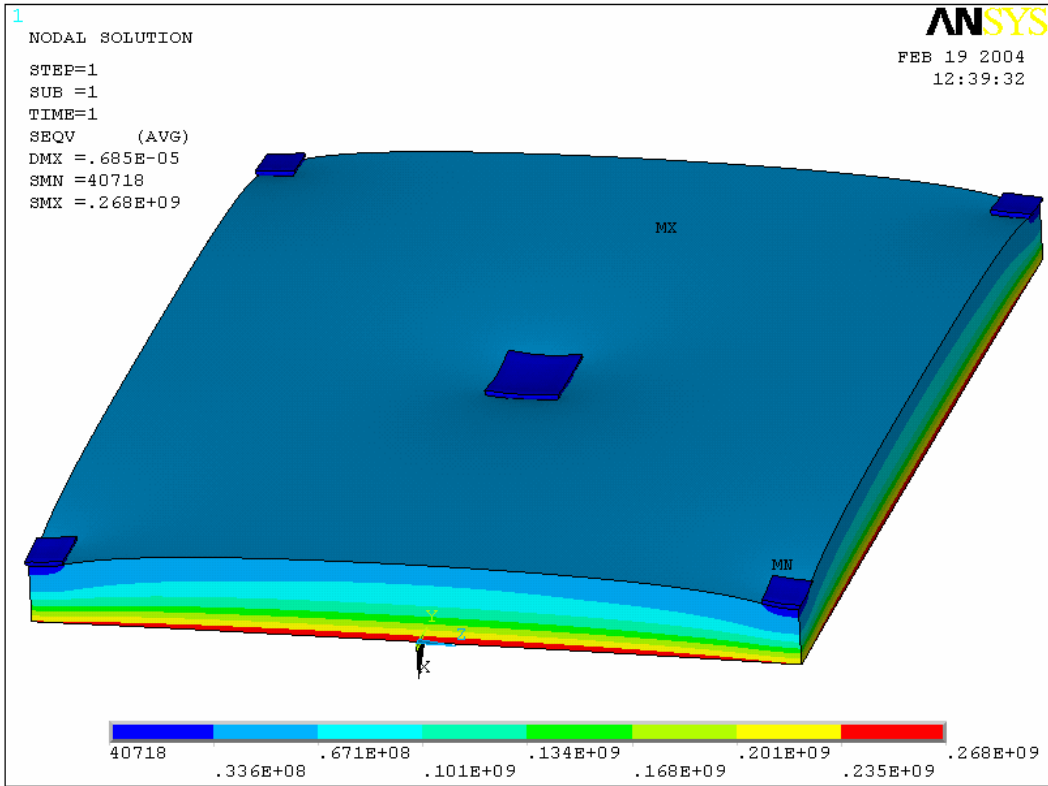

Figure 13: Von Mises Stress Distribution symmetry conditions imposed on edges. Temperature profile input is from $t = 8101.2$ sec (immediately after last pulse).

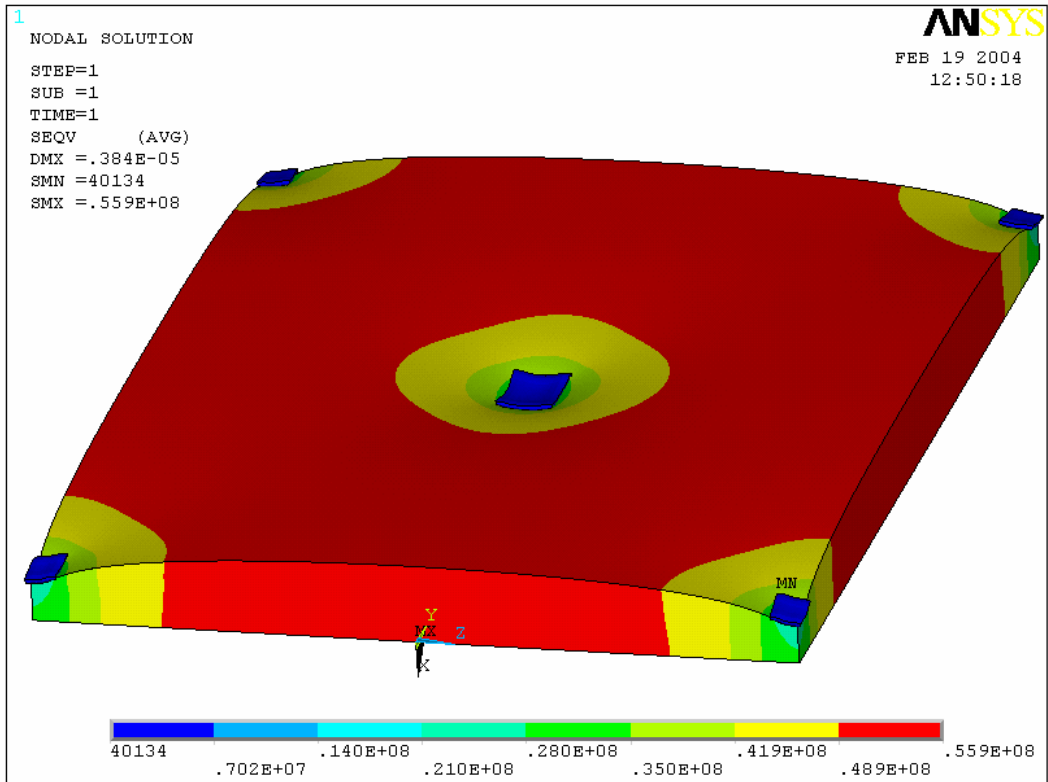

Figure 14: Von Mises Stress Distribution symmetry conditions imposed on edges. Temperature profile input is from $t = 9000$ sec (after cool down from last pulse).

Finally, Figure 15 shows the Von Mises stress values (in units of psi) for each of the cases run. The stress values are taken immediately after the last pulse at the point of maximum thermal gradient in the model. As expected, the largest thermal gradient shown above in Figure 8 corresponds to the maximum stress (ten inch vertical and eight inch horizontal spacing cooled with room temperature helium for 15 minutes). All stress values are below the ASME B&PV code (Section III, Division I) for secondary stress (thermal stress) as the values are all under three times the maximum allowable stress intensity value of 109,700 psi.

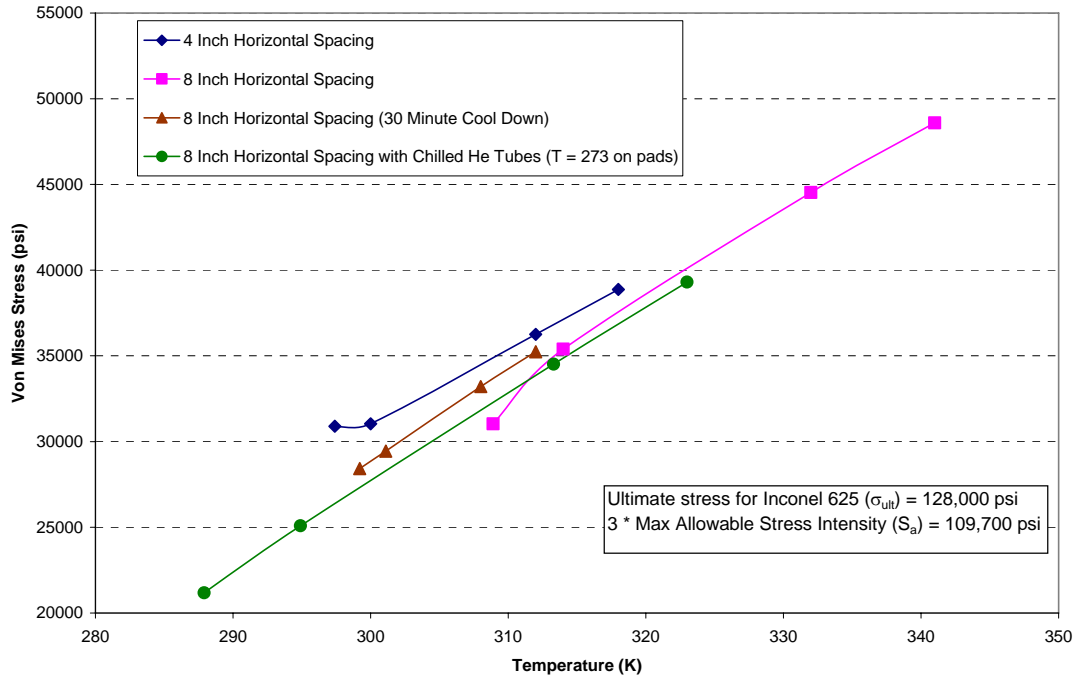

Figure 15: Von Mises stress as a function of clamp spacing (15 minute cool down).

V. Summary and Recommendations

Heat from the operational pulse has been applied to the model as a surface heat flux (36.8 W/cm²) for 1.2 sec representing both the highest total heat load to the vessel (12 MW) and the longest planned pulse. The temperature rise immediately after pulse on the lower surface of the vessel is 57 K. This corresponds well to the classic problem of a semi-infinite solid with a constant surface heat flux documented in Incopera and DeWitt³. The equation is shown below along with the corresponding calculated temperature change through the thickness of the Inconel.

$$T(x,t) - T(t) = \frac{2q_o''(\alpha t / \pi)^{1/2}}{k} \exp\left(\frac{-x^2}{4\alpha t}\right) - \frac{q_o''x}{k} \operatorname{erfc}\left(\frac{x}{2\sqrt{\alpha t}}\right) = 60 \text{ K}$$

Some of the temperatures distributions shown in Figures 8 do exceed the 313 K maximum steady state temperature imposed on this analysis. Most notably, the current design configuration of ten inch vertical clamp spacing and eight inch horizontal spacing fails to meet the design criteria as it achieves a steady state temperature of 341 K (68 C). Additionally, as the steady state temperature increases, the number of cycles required to achieve steady state also increases. For instance, the profile shown in Figure 7, representing four inch horizontal spacing and ten inch vertical spacing, approaches steady state after the fourth or fifth cycle whereas the default design case achieves its steady state value of 341 K after the eight or ninth cycle.

Figure 8 illustrates that the required steady state value can be achieved if one or more design parameters are changed. Reducing the vertical tube spacing (i.e. place more clamps on the vessel but maintain the same number of tubes) reduces the steady state temperature but only meets the 40 °C goal if the spacing is less than four inches. However, if the horizontal clamp distance is reduced to four inches, together with decreasing the vertical clamp distance to eight inches, the model does achieve the desired steady state temperature. The caveat here is that the number of tubes and clamps would have to be doubled in order to reduce the horizontal distance to four inches.

Another alternative is to wait longer between shots when the maximum pulse power (12 MW) is applied to the system. Simply waiting an extra 15 minutes or doubling the cool down time provides adequate cooling for any vertical or horizontal spacing cases in the model. In particular, allowing for extra time is the only case studied which meets the temperature criteria for the current geometric design configuration (ten inch vertical and eight inch horizontal staggered tube spacing).

A final alternative to reaching a maximum steady state temperature of 40 °C is to chill the Helium gas. Using refrigerated gas (T = 0 C) provides for a satisfactory steady state temperature once the vertical spacing is reduced to eight inches or less. Extra equipment, not currently in the design, would be necessary

³ Fundamentals of Heat and Mass Transfer 4th Edition, Incopera and DeWitt, *John Wiley and Sons*, New York 1996, page 239

to implement this situation in order to keep the gas at temperature. Another consideration and possible advantageous argument for using this case would be that the film coefficient will increase as properties of the gas are evaluated at the lower temperature. The approximation that the surface temperature is indeed the same temperature as the gas is highly dependent on the value of the film coefficient (see Figure 11) and any method used to raise its value will make the assumption of constant surface temperature stronger.

The effect of varying the heat flux from zero to a maximum of 12 MW for 1.2 sec (14.4 MJ) is presented in Figure 12. This plot can be used in conjunction with Figure 8 to determine the steady state vacuum vessel temperature for any of the geometric spacing and cool down time cases considered in this report. A linear line may be drawn from the steady state vacuum temperature (278 K), where no operational heat flux loading has been applied, to the full power temperature value for a specific case presented in Figure 8, in order to determine temperature response as the applied heat flux is lowered. Obviously, when the helium temperature is changed, the steady state temperature of the vessel with no heating will also change. Thus, a new temperature value should be calculated if at any time a cooler or chilled helium gas flows through the tubes.

The stress levels are all well under the required ASME B&PV allowable stress levels for secondary stresses as the maximum stress in all of the studies is 48,000 psi which is still a factor of two less than the recommended value of three times the maximum allowable stress intensity or 109,700. Not surprisingly, the max stress occurs immediately after pulse when the largest temperature gradient exists in the Inconel and is relatively uniform over the lower surface (location of applied heat flux) of the plate. Additionally, the maximum shear stress in the model is around eight times less than the corresponding directional stress further demonstrating the capable performance of the vacuum vessel in response to thermal loading.

Finally, examination of the gradient through the Grafoil pad doing a 15 minute cycle shows that there is very little gradient through the thickness. The maximum gradient through the material is only one degree and thus will have little to no effect on the operation of the Grafoil pad.

Closure:

The original design (ten inch vertical spacing, eight inch horizontal spacing cool down time of 15 minutes) **does not meet** the steady state 40 °C design criteria imposed for a 12 MW pulse for 1.2 sec. However, Figure 8 illustrates that the temperature criteria **will be met** if the one of the following conditions are allowed:

1. Vertical clamp spacing is reduced to less than four inches.
2. Horizontal clamp spacing is reduced in half to four inches and vertical spacing is reduced to at least eight inches.
3. The time allowed for cool down is increased to 30 minutes in cases where the maximum power (12 MW for 1.2 sec) is applied to the system.
4. Chilled He is used instead of room temp He gas and the vertical spacing is reduced to less than eight inches.

It may not be necessary to implement geometric considerations (clamp/tube spacing) everywhere. Instead, since the heat flux will undoubtedly not be uniform through the vessel shell, more clamps/tubes can be added to the areas that locally experience the maximum heating and all other areas can be more loosely spaced. This type of geometric vacuum vessel analysis is outside of the scope of this report but such an analysis could be used in conjunction with this DAC to arrive at an optimum design.

Update 5-5-04

The Vacuum Vessel SRD [NCSX-BSPEC-12-00-dE Section 3.2.1.2.6] vessel temperature requirement has been revised subsequent to this document. The new requirement states that all in vessel components except for Plasma Facing Components shall return to a prescribed pre-pulse temperature in the range of 40-80°C. This 80 °C requirement supercedes the older 40 °C requirement referenced throughout this report. A reexamination of Figure 8 indicates that all of the cases studied in this report meet the 80 °C or 353 K maximum steady state temperature. That is, the original tube spacing configuration, calling for 10 inch vertical spacing and 8 inch staggered horizontal spacing with a 15 minute cool down, meets the 80 °C maximum steady state temperature requirement. Thus, the 4 conditions documented above do not need to be implemented.

5-30-06

Addendum: Research and Development Testing at MDL laboratory in Knoxville Tennessee

Section 1> Verification of experiment using ANSYS thermal transient FEA model

Research was conducted to verify the heat transfer capability of the design for the saddles to be used on the NCSX Vacuum vessel. The analytical model used to describe the geometry is shown below slide 1 and the actual experimental setup is shown in slide 2.

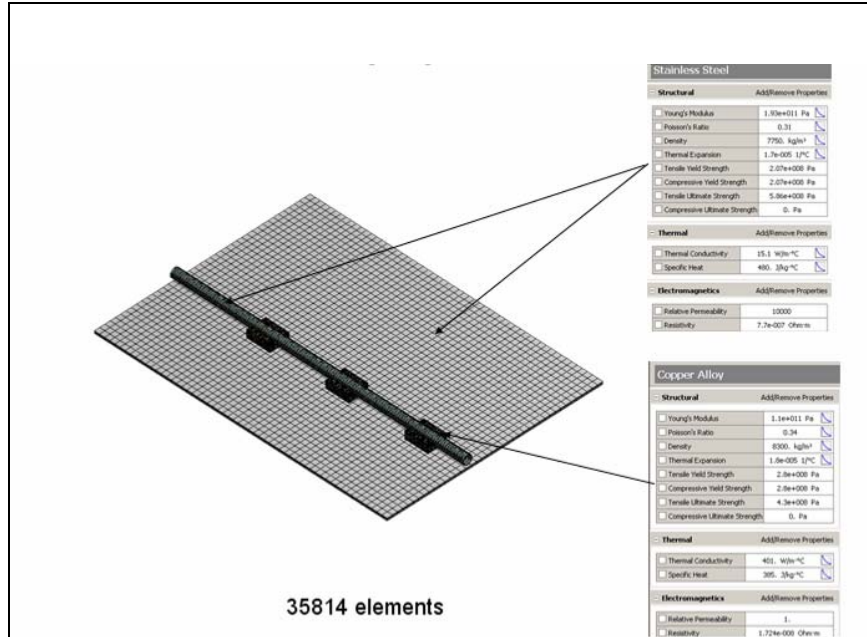

Slide 1: Experimental model setup and theoretical properties

- Utilized existing MDL resources
 - Oven
 - Thermocouple controller
 - Braided hose
 - Building compressed air for cooling
- Setup geometry was not meant to be completely duplicate nor was helium source available nor was very high pressure air.
 - Curved SS plate represented WV NSTX center stack mockup with studs
 - Cu saddle were fabricated to correct geometry
 - Hose was prototype
- Smooth tubing test used Cu tube with SS insert to represent tube wall
 - permitted using same saddle and at same time duplicating hose flow parameters (h, v)
 - large SS tube overloaded building capacity

Test Assembly With Braided Hose

Tube
SS
Saddle
Gasket
Tube Assy

Slide 2: Actual setup and equipment list at the MDL laboratory in Knoxville TN.

The locations for the thermocouple locations in both the analytic model and the real world experiment are shown in slide 3.

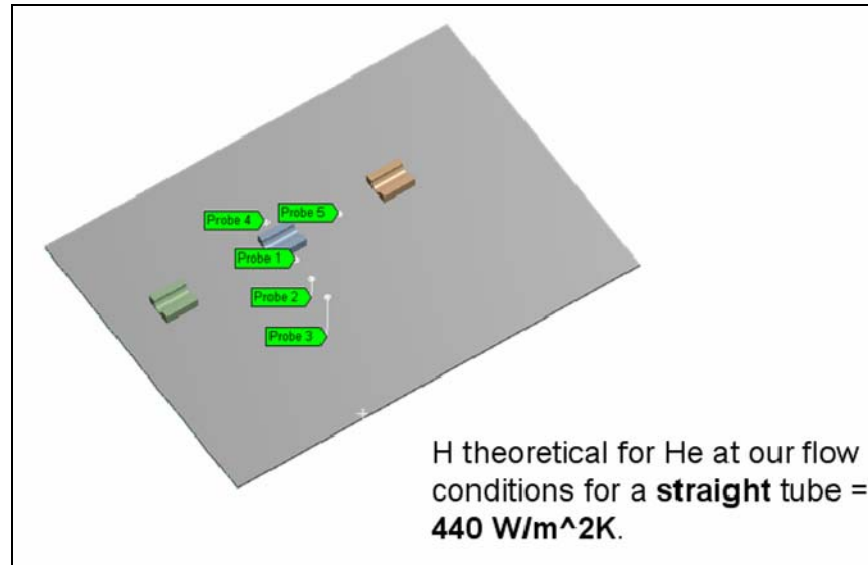

Slide 3: Straight tube approximation thermocouple locations

The analytic model can only calculate heat transfer for straight tube sections directly (the calculated film coefficient is shown above in slide 3). To calculate for the heat loss through braided tubing the following procedure was applied.

- Since no theoretical calculation for film coefficient can be made for the braided tube case (due to the increased thermal resistance of the braid and an uncertainty in the flow geometry of the corrugations), ANSYS will iterate the film coefficient on the tube surface to most closely match the experimental results on TC #1.
- The resulting iterated film coefficient is 175 W/m²K.

Slide 4 illustrates the heat profile from a view directly above the plate for 15 and 30 minutes. After 30 minutes there is still a region that is not cooled near the lower left corner. Slides 5-9 show the heat profile of each of the thermocouples in both the experiment and the finite element model. The experimental points and the ANSYS temperature agree well with each other.

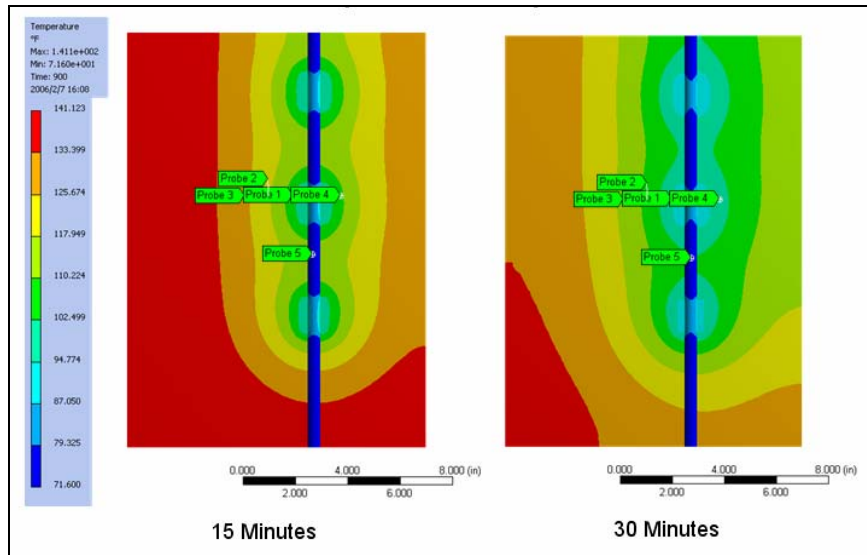

Slide 4: Temperature Profiles (Top View) for T = 15 and 30 minutes; $h = 175 \text{ W/m}^2\text{K}$ (same scale)

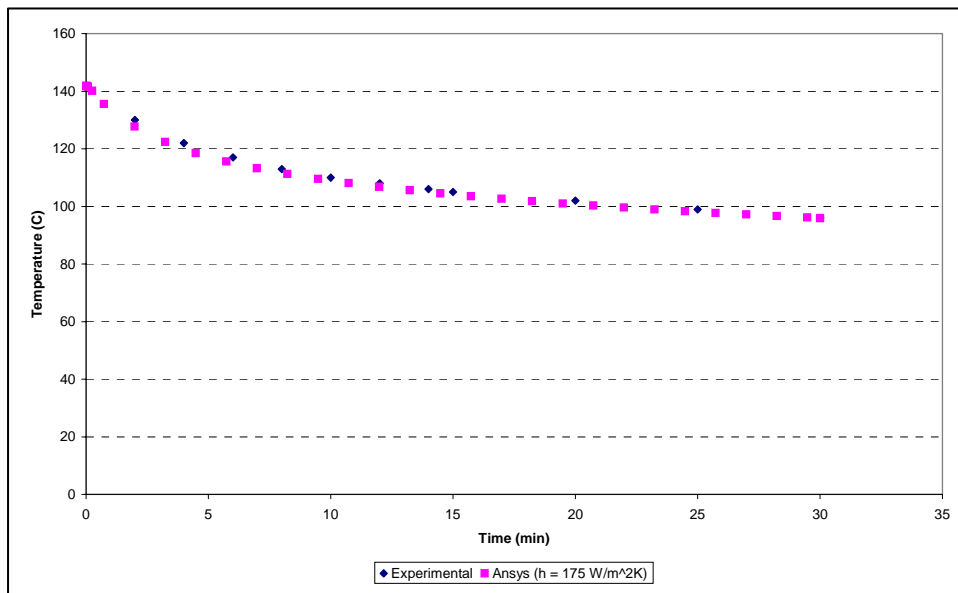

Slide 5: Braided tube comparison: Temperature vs. time for TC #1

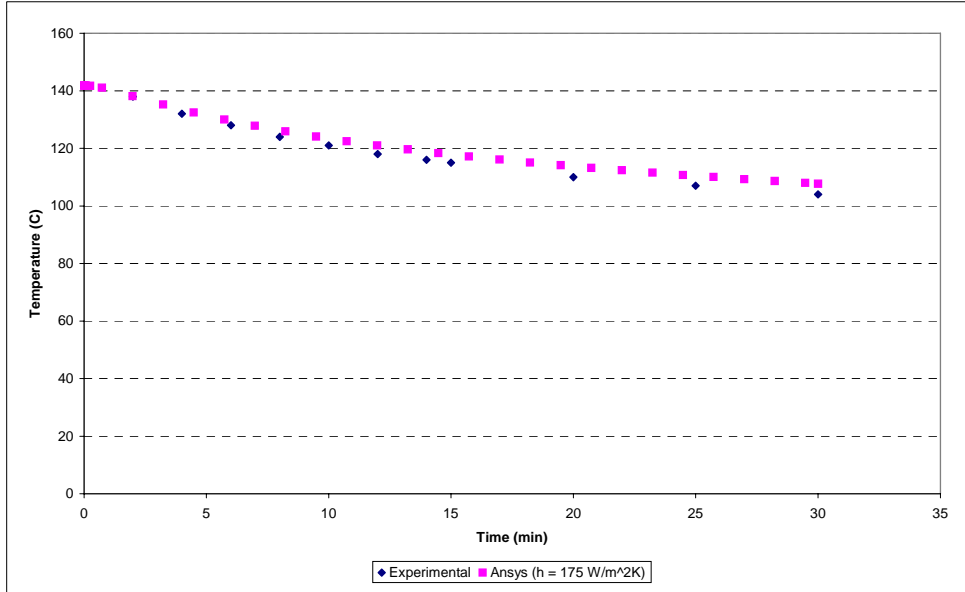

Slide 6: Braided tube comparison: Temperature vs. time for TC #2

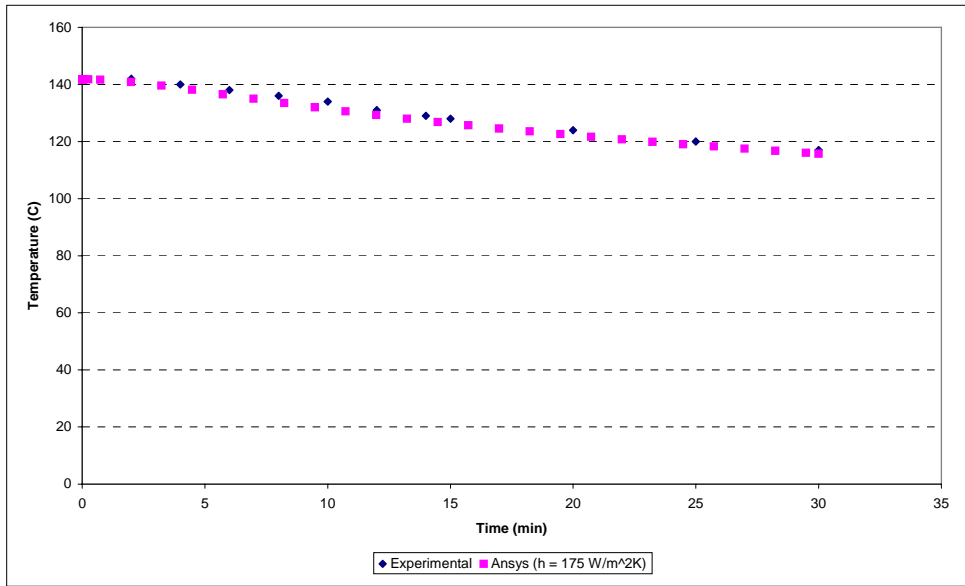

Slide 7: Braided tube comparison: Temperature vs. time for TC #3

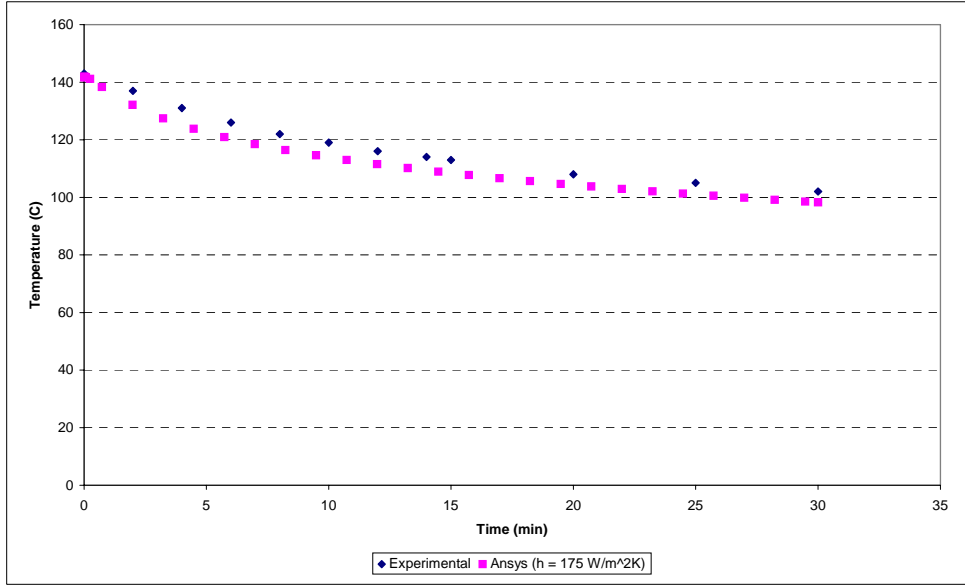

Slide 8: Braided tube comparison: Temperature vs. time for TC #4

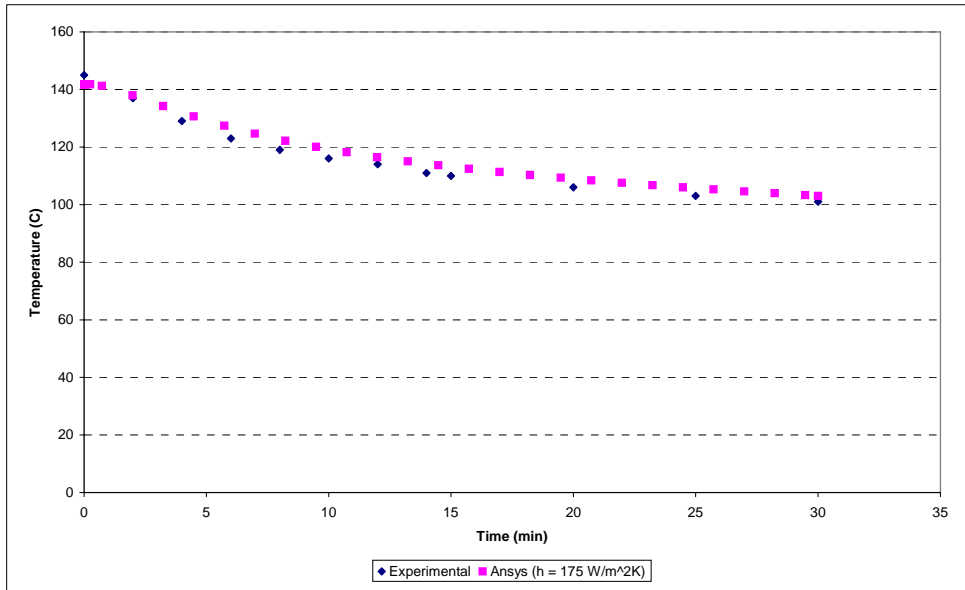

Slide 9: Braided tube comparison: Temperature vs. time for TC #5

Section 2> FEA model of vacuum vessel saddles geometry and spacing

This model has the following considerations:

- Same Geometry for the saddles and tubing as the experimental model
- 368,617 W/m² heat flux applied to back of vessel
- Cooling to Cryostat is applied to the vessel volume as a -12200 W/m³ heat generation rate.
- Film Coefficient of 175 W/m² K, sink temp = 294 applied to interior tubing surfaces
- Nominal tube spacing is X = 4.5 inches and Y = 5 inches

The geometry of the saddles and the spacing are shown in slide 10.

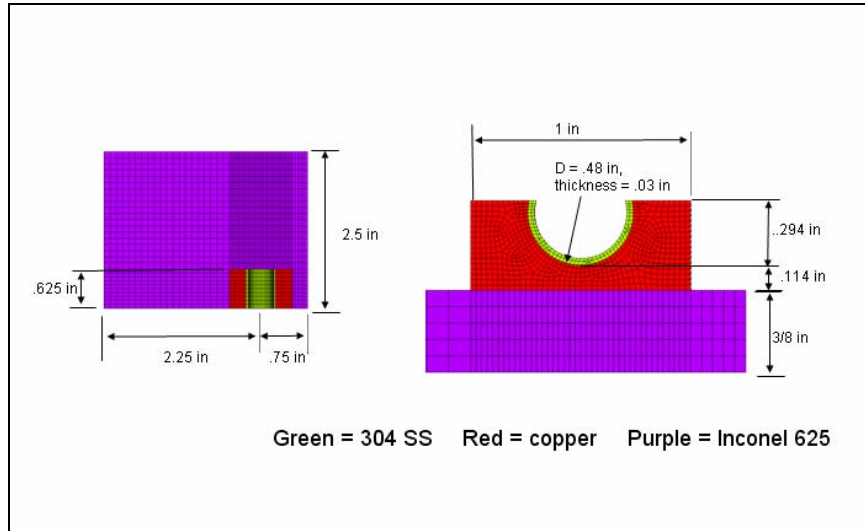

Slide 10: FEA model of the spacing and saddle geometry on the NCSX vacuum vessel

The next series of slides (11-13) show the thermal results the nominal case where all tubes all functioning as expected.

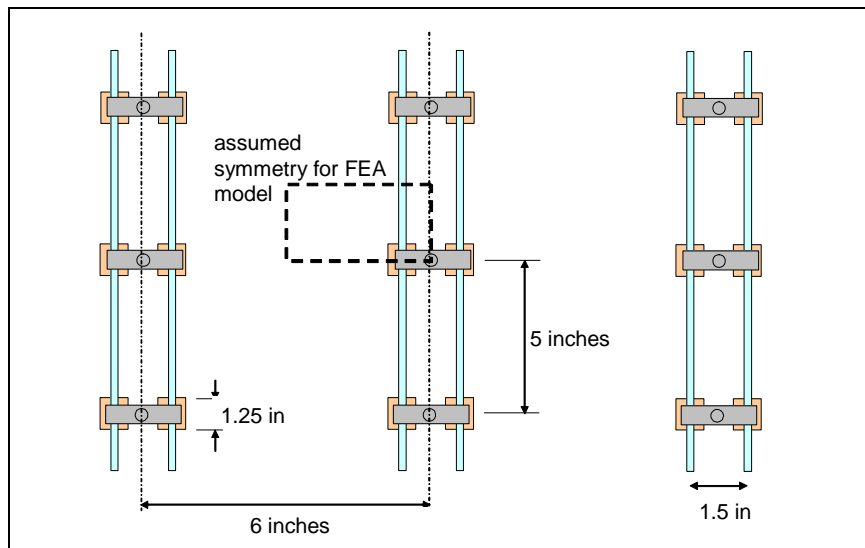

Slide 11: Nominal Case: All tubes/saddles operational

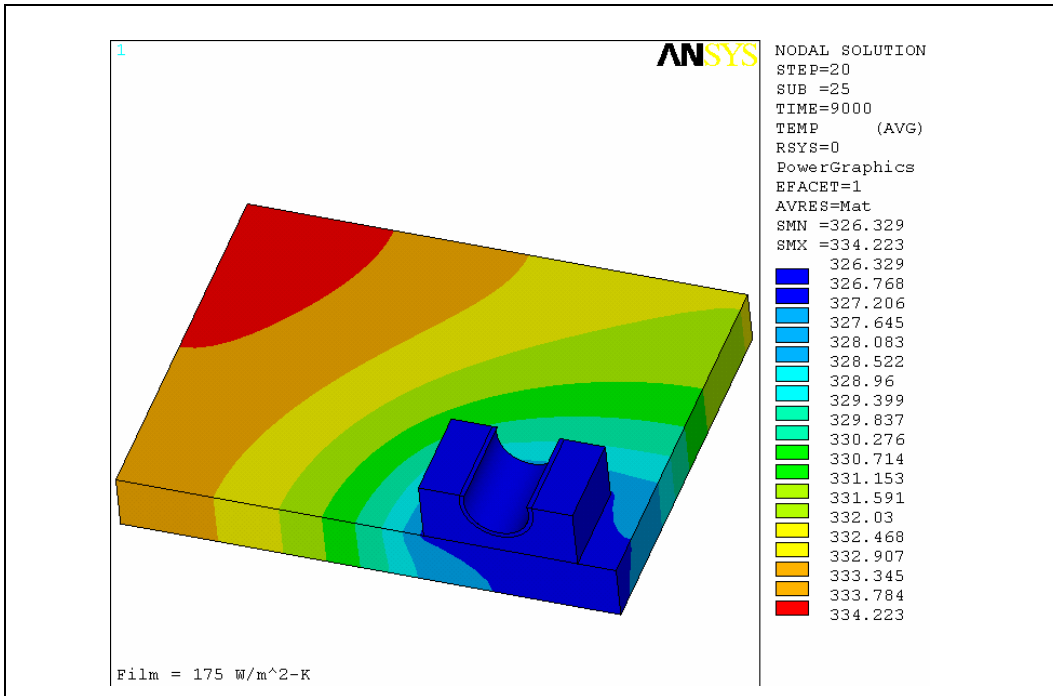

Slide 12: Temperature (K) profile after last cycle

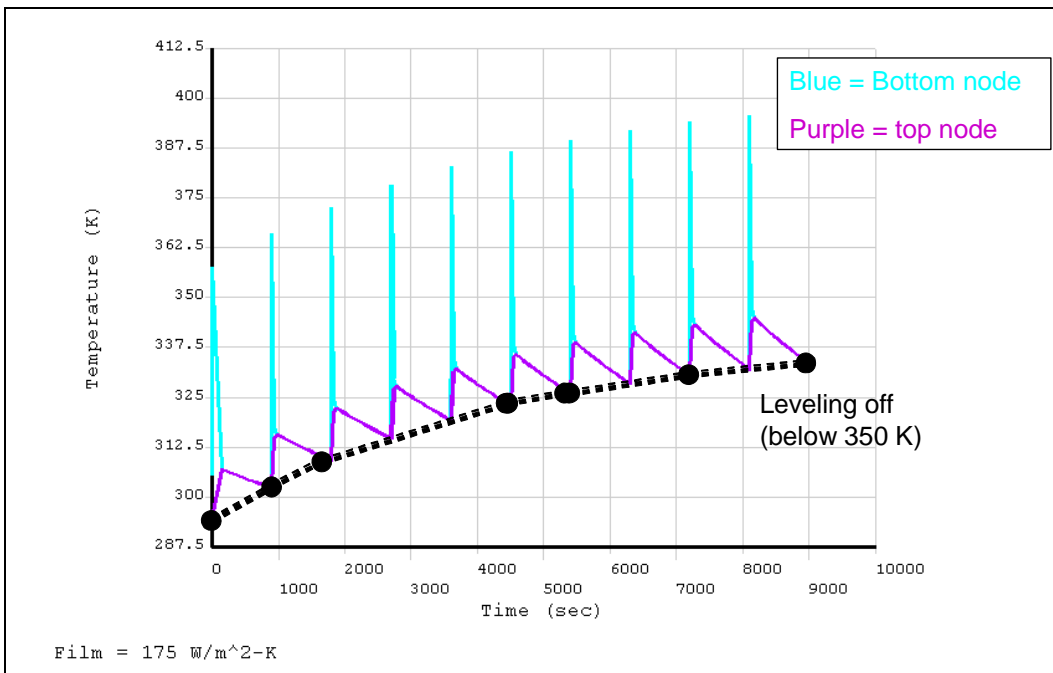

Slide 13: Nodal temperature history for corner nodes farthest from the cooling saddle

Slides 14-19 illustrate the effects of varying the distance between saddles and the effect of loosening two saddles or an entire tube respectively.

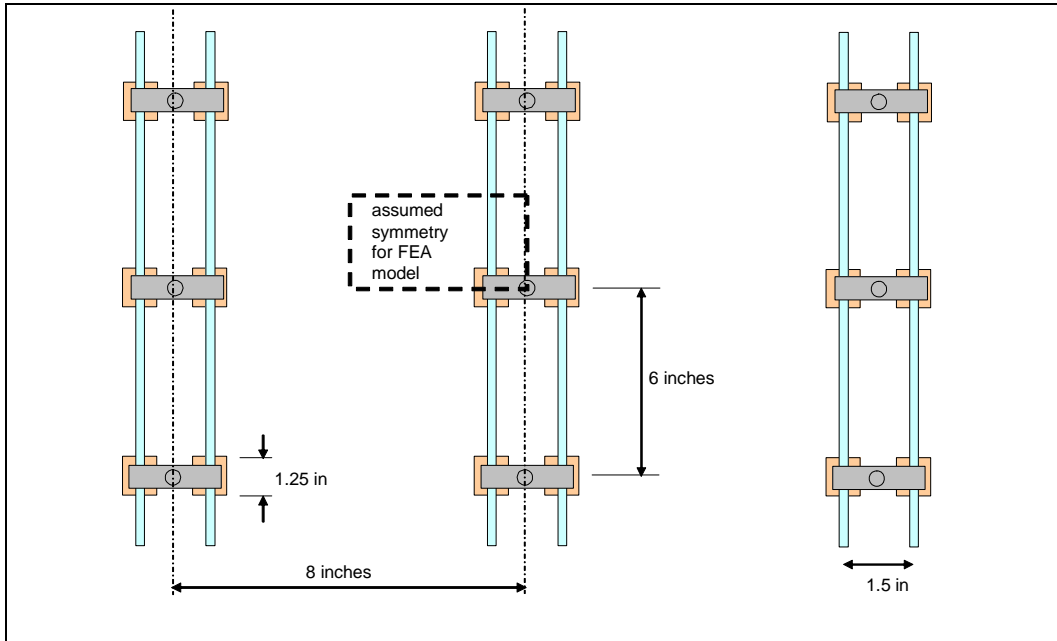

Slide 14: Max horizontal spacing: All tubes/saddles operational

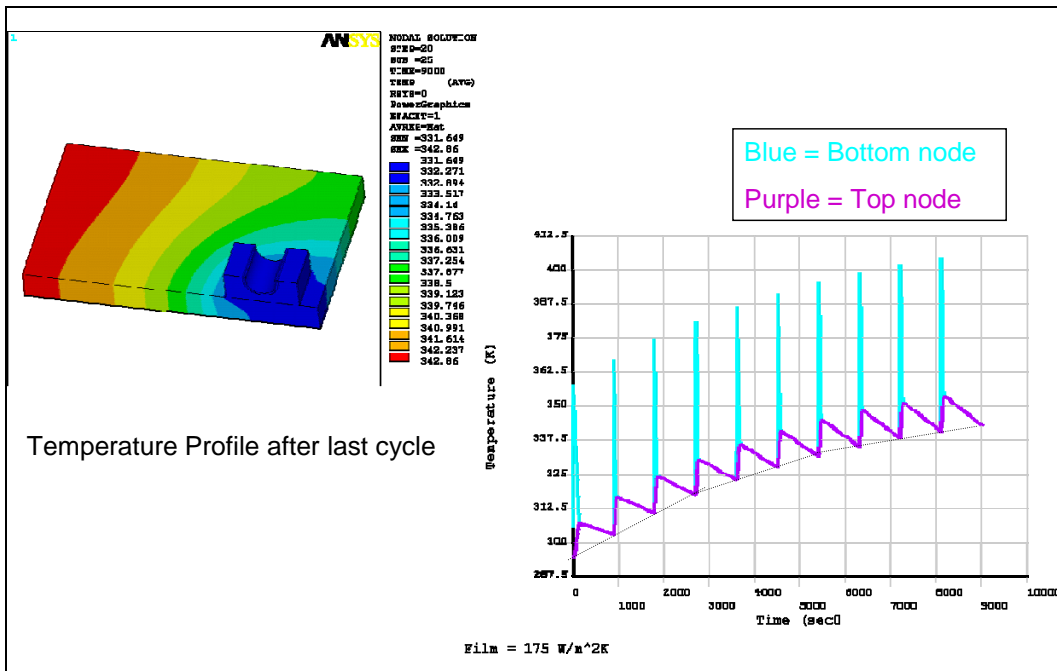

Slide 15: Ratcheting with max horizontal spacing (film = 175 W/m²K)

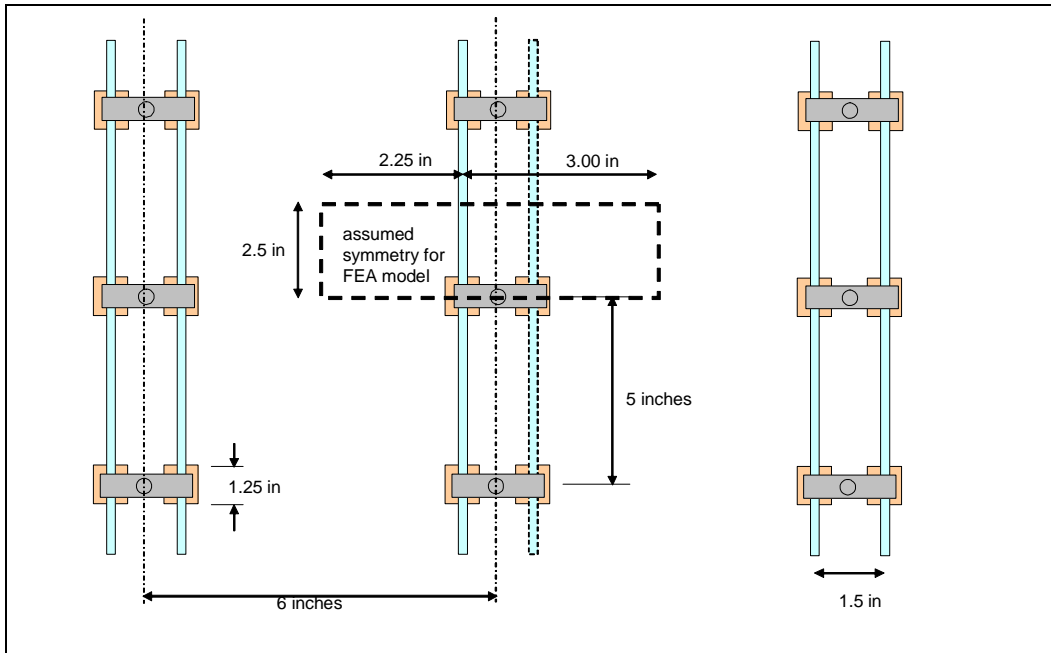

Slide 16: Missing Tube: All saddles operational (Nominal condition)

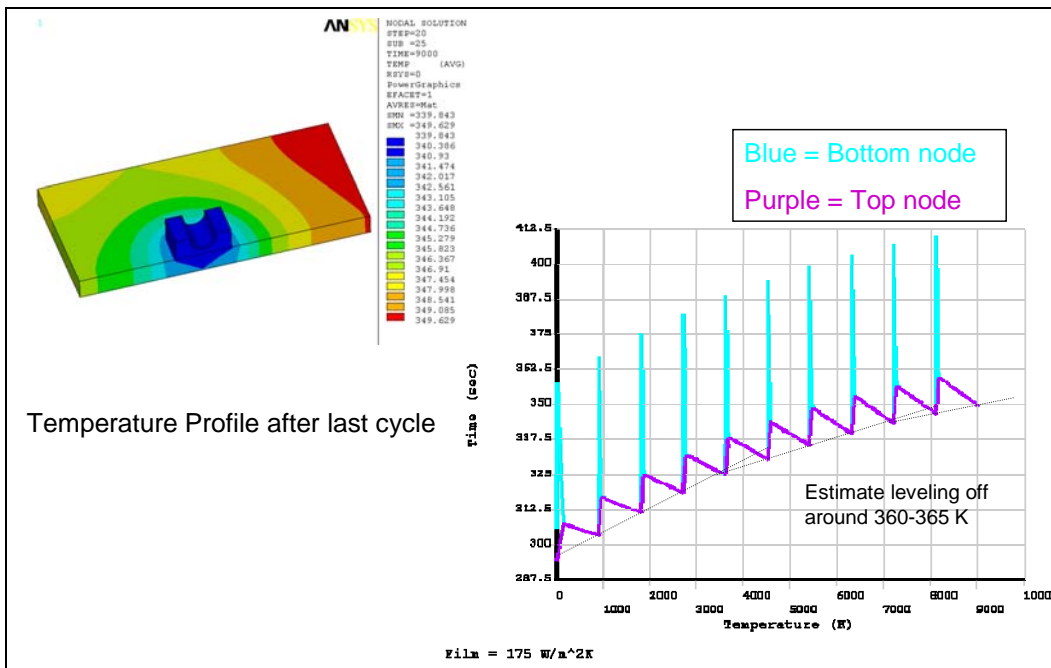

Slide 17: Ratcheting with loss of tube (film = 175 W/m²K)

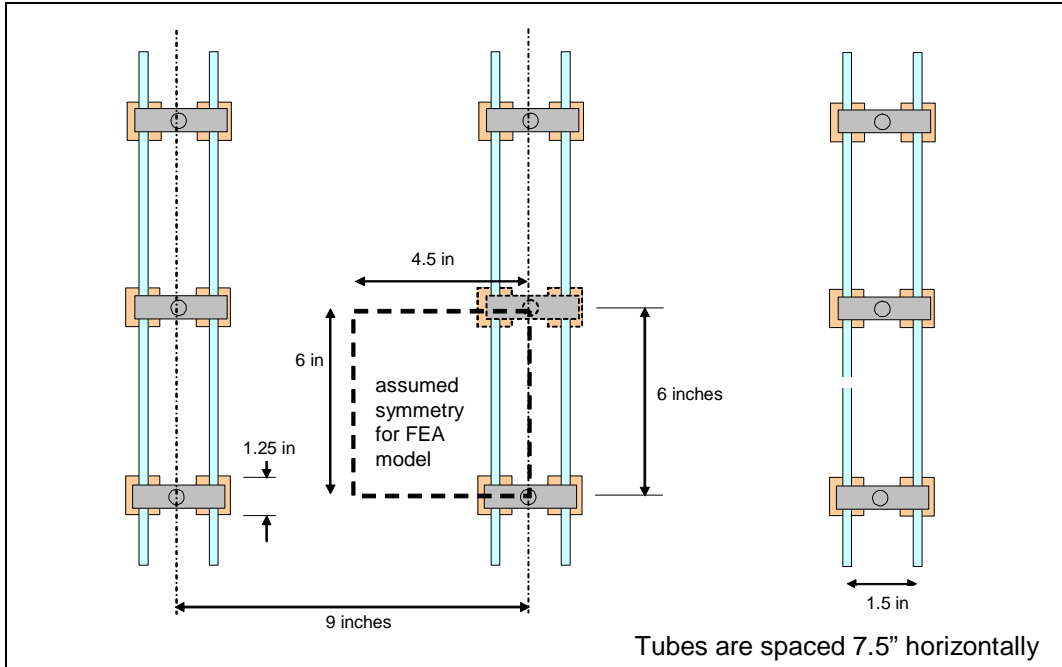

Slide 18: Missing Saddles: All tubes but two missing saddles, one stud (Absolute max spacing condition)

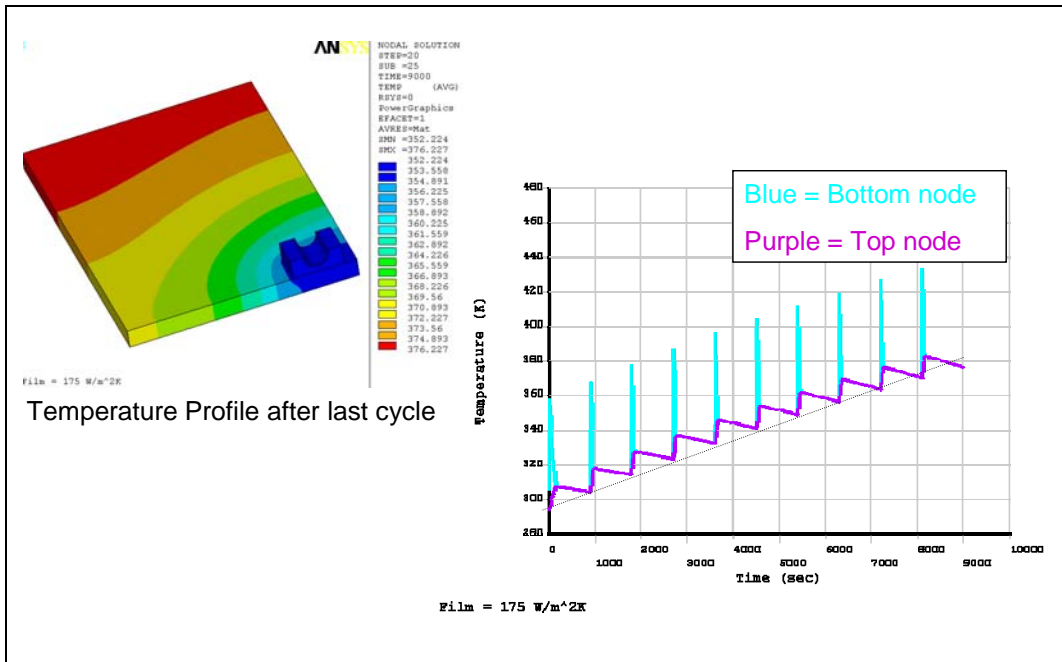

Slide 19: Ratcheting with loss of saddles (film = 175 W/m²K)

General Comments and conclusion of research and development testing at MDL laboratory

- Corrugated tubing has a very high thermal resistance through the braids which appears to dominate the heat transfer resistance network.
- Increasing the “real” film coefficient (raising pressure, density, etc) in the gas inside the corrugated tubing is likely to have little effect due to the dominate resistance of the braids.
- Spacing is the chief issue with these tubes. More saddles will be needed than for the smooth tube counterpart.
- Smooth tubing would eliminate the thermal resistance in the braid and would allow for higher film coefficient (thus more cooling). Smooth tubing, on the other hand, does not bend to our specifications and thus unfortunately cannot be used.

Appendix A: Hand Calculation Check by P. Goranson

Overview

At steady state operation, between shots, the vessel plate temperature ratchets to a temperature varying from 294 K at the cooling bracket to 313 K at points midway between brackets. This gradient results in thermal stresses due to internal restraint of the material. The ANSYS model predicts these stresses to be on the order of 2785 psi near the boundary of the cooling bracket/pad.

Checks

The inputs to the ANSYS were checked for accuracy. The Inconel material properties were checked against values found in the Machine Design Material Selector and values for the Grafoil were obtained from the Vendor's (UCAR) web site. The temperature assumptions were taken from NCSX-CALC-123-03, NCSX Vacuum Vessel Heating/Cooling Distribution System Thermo-hydraulics Analysis.

Hand Analysis

Reference: Roark Sixth Edition
Stresses due to internal constraint
Page 722. Case 12
Disk heated about center, temperature a function of distance from center only.

Assumptions:

The vessel plate may be represented by a flat circular disk, 8 inches in diameter, the mean distance between brackets. The plate curvature is slight and flatness should be a valid approximation. The heated region is small compared to the plate size and the radius drops out in the solution, so the circular section is not a concern.

The heat gradient is linear. This is not true for the real plate, however, a fitted linear gradient approximates the temperature distribution and should not give results within a partial order of magnitude.

Radial stress

$$\sigma = \gamma E \left[\frac{1}{R^2} \int_0^R T_R r dr - \frac{1}{r_1^2} \int_0^{r_1} T_{r_1} r dr \right], \text{ where } T \text{ is the temperature gradient from the cold center to a radius}$$

r out in the disc, and R is the disk radius.

The integral solution is:

$$\sigma = \gamma E \left(\frac{T_R}{2} - \frac{T_{r_1}}{2} \right)$$

At small r_1 the delta temperature $T_{r_1} = 0$, therefore:

$$\sigma = \gamma E \frac{T_R}{2}$$

Let Young's Modulus $E = 28e+6$ psi

$$T_R = 19$$

Coefficient of expansion $\gamma = 7e-6$ in/in-F

Results

$$\sigma = 3640 \text{ psi}$$

It is interesting to note that Case 10, which is the same disk with a comparatively small central circular

portion at a delta temperature, results in the same maximum stress, i.e. $\sigma = \gamma E \frac{\Delta T}{2}$

This confirms that small heat affected zones in flat plates have similar stresses.

Conclusions

The ANSYS analysis probably does not give totally accurate stress since it assumes a finite flat plate rather than a curved continuous one. Also, the results are dependant on the edge conditions assumed, the simple supports giving a stress of 2785 psi (Figure 8) at the bracket and the fixed edges 5100 psi. The 8000 psi stress found at the fixed edges are an artifact of over constraining the model and resulting externally induced stress, not representative of the actual geometry.

The hand calculated stress of 3640 psi gives close enough correlation in both location and magnitude to give confidence that the ANSYS model is sufficiently accurate, particularly in light of the resulting large safety factor