

NCSX
Design Basis Analysis

Vacuum Vessel Heat Balance Analysis

NCSX-CALC-12-003-01

21 March 2006

Prepared by:

P. L. Goranson, ORNL

I have reviewed this calculation and, to my professional satisfaction, it is properly performed and correct. I concur with analysis methodology and inputs and with the reasonableness of the results and their interpretation.

Reviewed by:

F. Dahlgren, PPPL Engineer

Controlled Document

THIS IS AN UNCONTROLLED DOCUMENT ONCE PRINTED.

Check the NCSX Engineering Web prior to use to assure that this document is current.

Introduction

The NCSX Vacuum Vessel (VV) utilizes gas tracing hoses on the exterior vessel wall and electrical resistance heaters on the port extension walls to provide heating during bakeout and standby operation of the vessel. The tracing also provides cooling of the VV after operational shots. Insulation is provided to limit the heat losses from the vessel system to the cryostat and Modular Coils (MC), both of which are maintained at cryogenic temperature. The VV is hung from the MC shell structure by support rods which are insulated to limit heat loss to the MC. Analyses were performed to determine the heat losses through the insulation and heat inputs required to maintain steady state thermal equilibrium. The results of these analyses are being used to determine the adequacy of the vessel tracing and electrical heaters and to determine their operating parameters.

Performance Requirements and Criteria

The NCSX Vacuum Vessel System Requirements Document, NCSX-BSPEC-12-00 requires that:

- The vacuum vessel and interior components must be baked at 350 C and maintained at 40-80 C before and after operational shots.
- During bakeout, the port extensions are to be maintained at 150 C at the flanges ends and 350 C at vessel end, with gradient between.
- **During MIE operation the vacuum vessel and ports must be baked at 150 C.**
- The cryostat and modular coils are maintained at 80 K during both bakeout and standby operation.

Methodology

The analysis was done as a spreadsheet in MICROSOFT EXCEL representing the vessel and ports as simple areas conducting heat across insulating layers to constant temperature heat sinks. Input variables to the spreadsheet were insulation thicknesses, conductivity, vessel temperatures, and surface areas. The outputs were the heat loss from the vessel body and port extensions to the cryostat and coil bodies. The port heating/cooling balance was done with finite differences, iterating along the port length until the boundary conditions [temperatures] were met. The output was the net loss and heat in. The values for a typical port were converted to surface fluxes which were used as typical values to estimate the totals for all ports.

Assumptions

Temperatures(K)

- Crostat & Coil 80
- Vessel bake - upgrade 623
- **Vessel bake – MIE 423**
- Cryostat Exterior 288
- Vessel idle 293

- Ambient 293

Dimensions

- Cryostat is 123" radius by 119" tall.
- Vessel area, excluding ports is 52200 in².
- Port standpipe area is 65000 in².
- Coil area facing vessel is 23400 in².

Material Properties

Insulation blanket conductivity = 0.0002 w/cm-K

Pellet insulation conductivity = 0.0004 w/cm-K

N2 heat vap. J/g at 77K = 197.6

Insulation thicknesses

The space between the VV and the MC coils and structural shell are assumed to be backfilled with insulation pellets[Perlite or equivalent] and the values given for thickness are average values.

The port extensions, cryostat wall, and port covers are assumed to be covered with blanket insulation of constant thickness.

An efficiency factor of 75% is assumed for the blanket insulation and 100 % for the backfill.

Vessel port face thickness(cm)	Cryo foam thickness(cm)	Backfill insul. effec. thick.(cm)	Port insul. thickness(cm)	Path to coil (cm)	Port cover (cm)
19.8	20.0	30	5.1	23	2.54

Results

Thermal loads. Rows are for insulation values listed in chart under Insulation Thickness.

Figure 1 VV Thermal Loads

	Vessel to Cryo Qt kW	Cryo inleak Qv kW	Vessel to Coil front Qc kW	Vessel Port to ambient Qa kW	Cover Vessel to coil sides Qci kW	Vessel to Cryo Port to Cryo Qp kW	Vessel Coolant Qn kW
350 Bake	0.2	3.3	1.7	1.0	1.4	9.75	-8.17
Idle	0.1	3.3	0.5	0.0	0.4	4.7	-1.02
150 bake	0.2	3.3	1.0	1.0	0.9	7.55	-4.75

Figure 2 VV Utility Loads

	LN2 consumption l/hr	Qe exterior heating kW	Qh port heating kW	Total Coil Coolant load(kW)	Total (gas & liq) Cryo system load(kW)
350 Bake	377	2.51	-5.85	3.3	16.4
Idle	152	2.51	-4.64	1.5	6.7
150 Bake	293	2.51	-5.85	1.94	13

Figure 3 Vessel Heat Balance Model

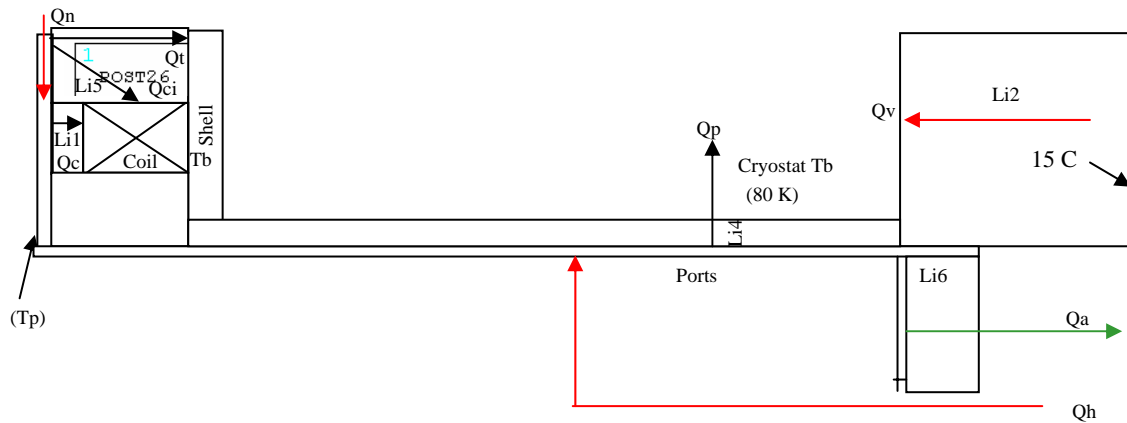
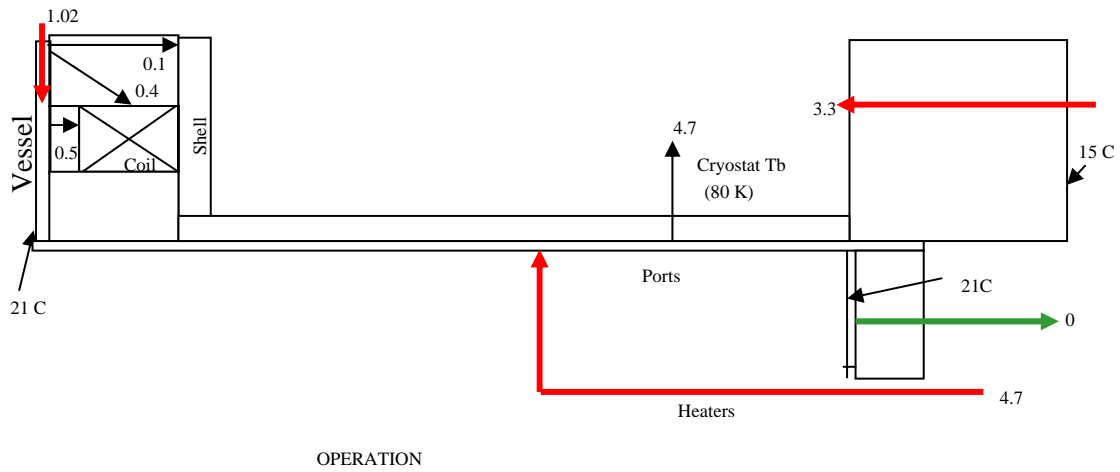
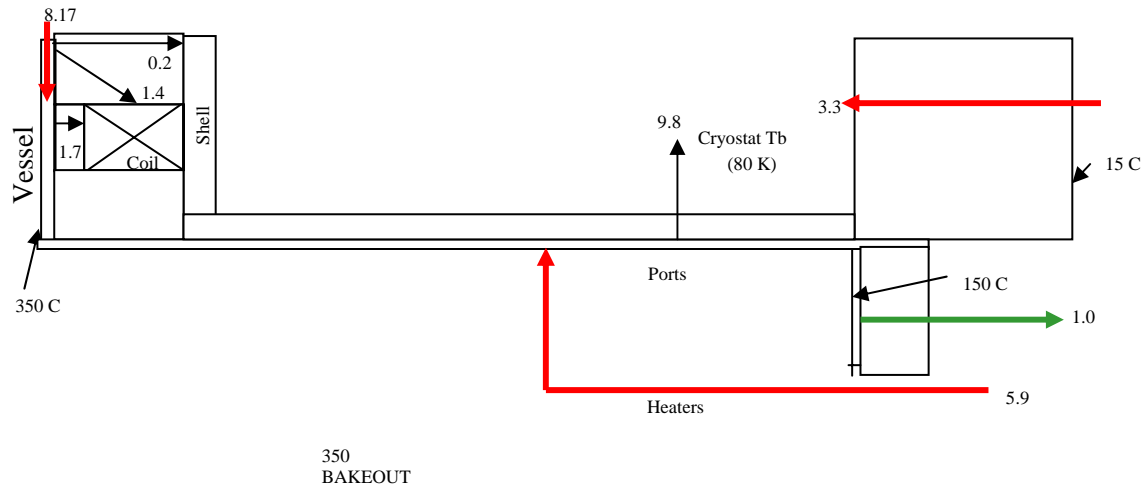
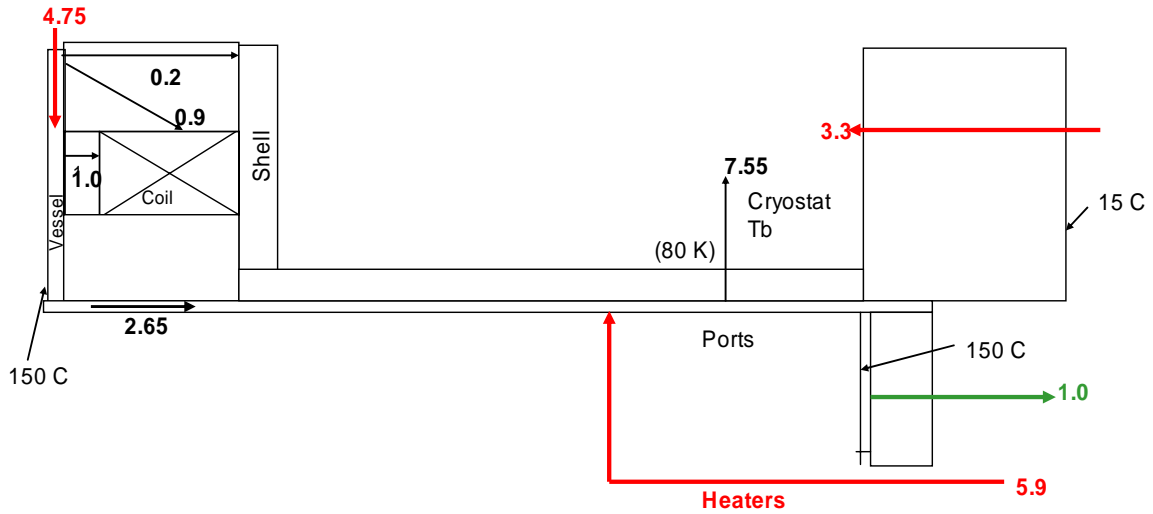

Figure 5 VV Bakeout and Operational Loads





150 C BAKEOUT

Port Losses

Model is calculated in reverse, starting at flange, adding heat. Heaters are represented by negative input value.

Figure 6 Port Loss Model

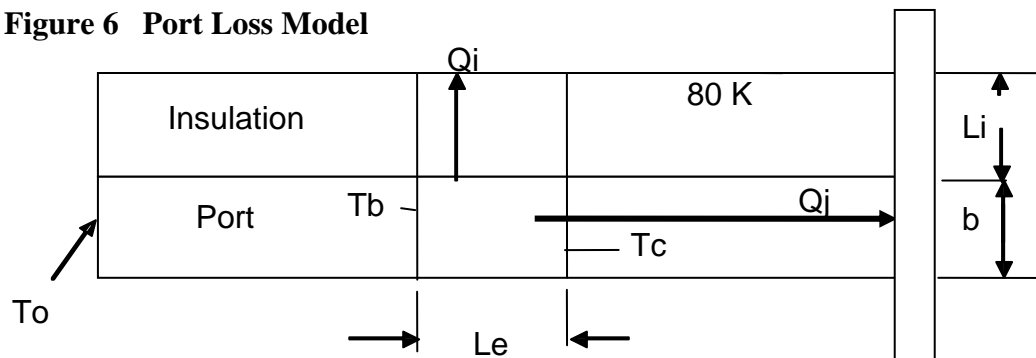

Results

Figure 7 Port Temperature Distribution during Bakeout

Based on a 8” diameter port, 1 meter long. Heat input to the port is 65 watts.

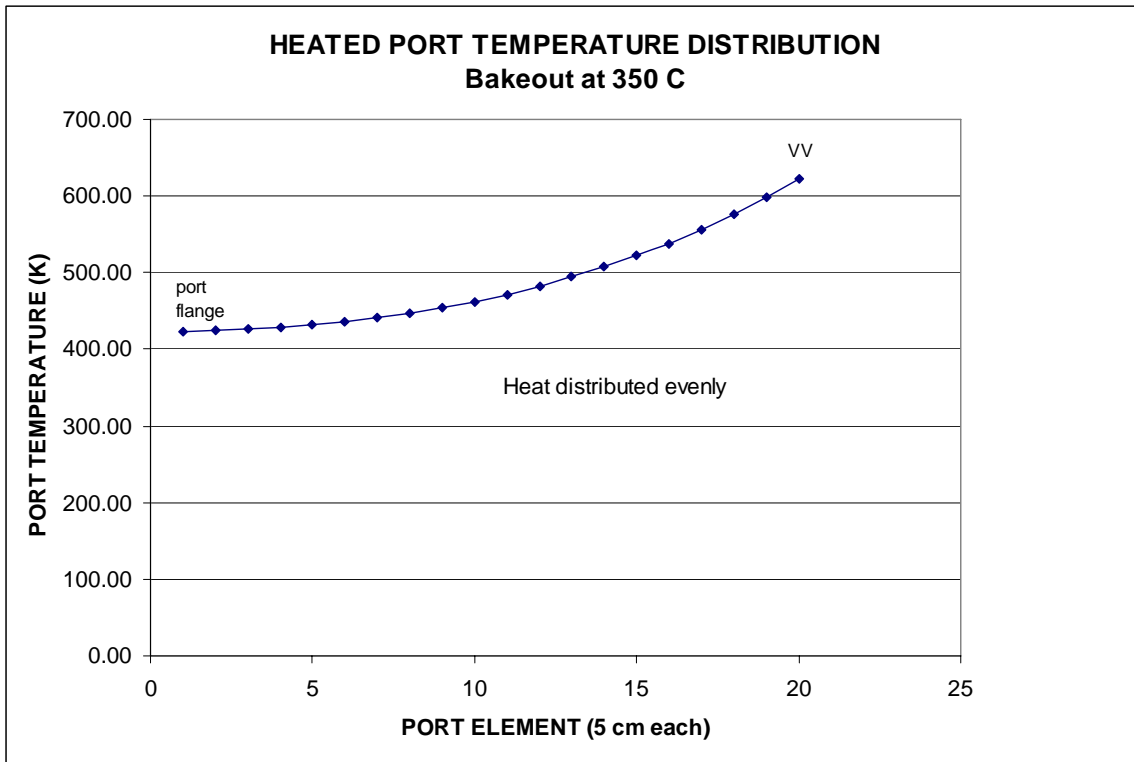

Figure 8 Port Temperature during Operation

Based on a 8” port, 1 meter long. Heat input to the port is 54 watts.

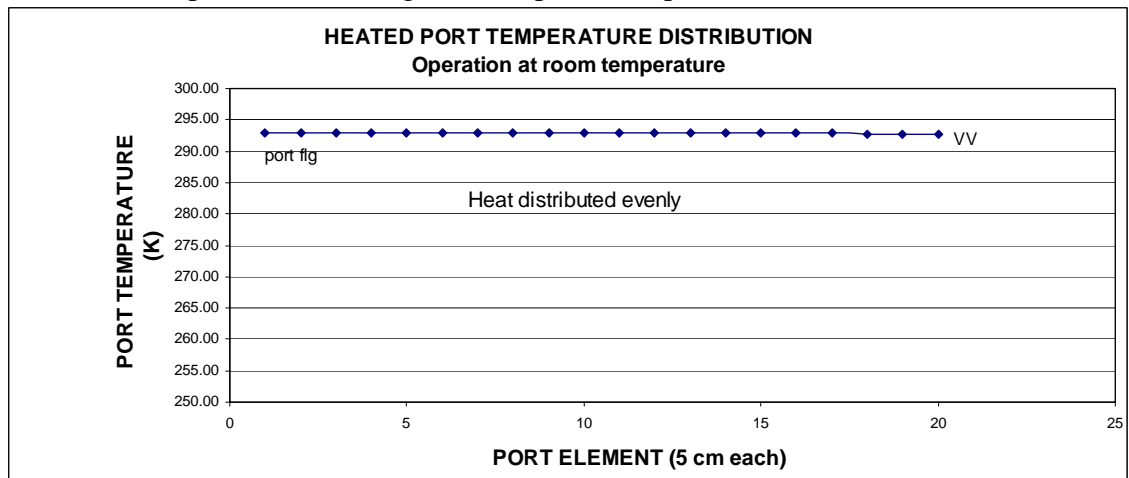

Figure 9 Port Temperature during Operation

Heat applied over outer half of 8" port. Heat input to the port is 33 watts.

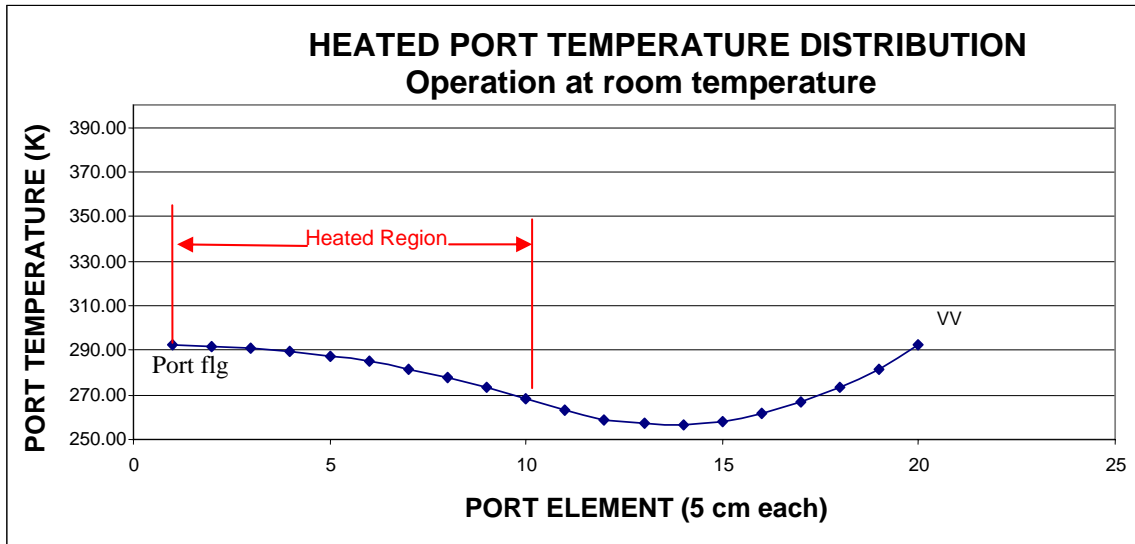
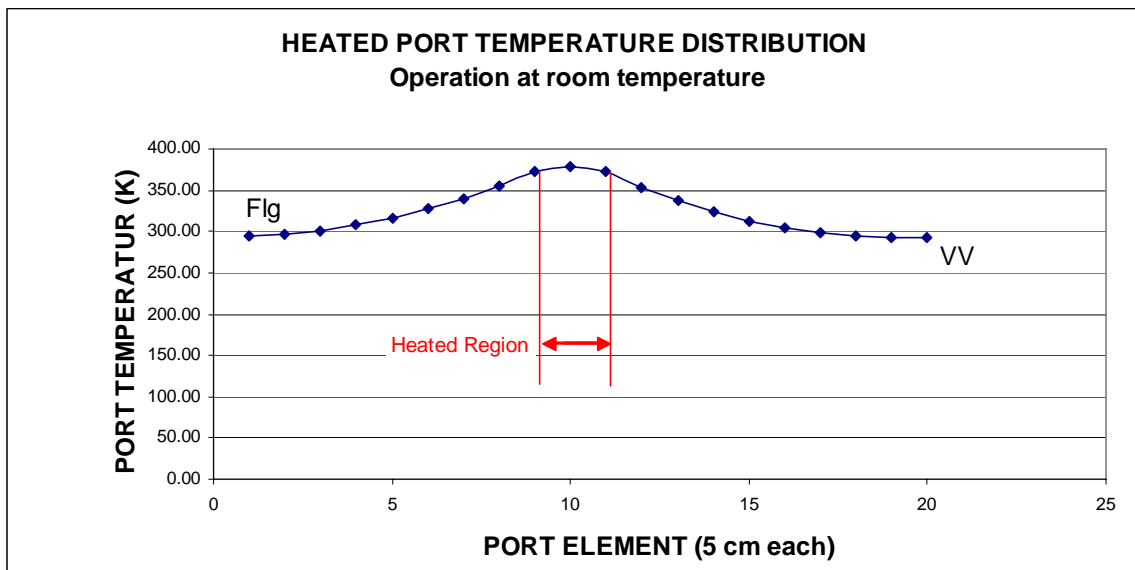

Figure 10 Port Temperature during Operation

Heat applied at midpoint of 8" port. Heat input to the port is 58 watts.



VV Support Rods

The VV is hung from six support rods fabricated from titanium alloy or Inconel which minimizes thermal growth and heat loss into the MC structure. The rods are wrapped in insulation and rest on insulation washers which provide additional thermal isolation. A schematic of the support rod design is shown in Figure 11. Perfect thermal contact is assumed at the VV end.

Figure 11 Support Concept

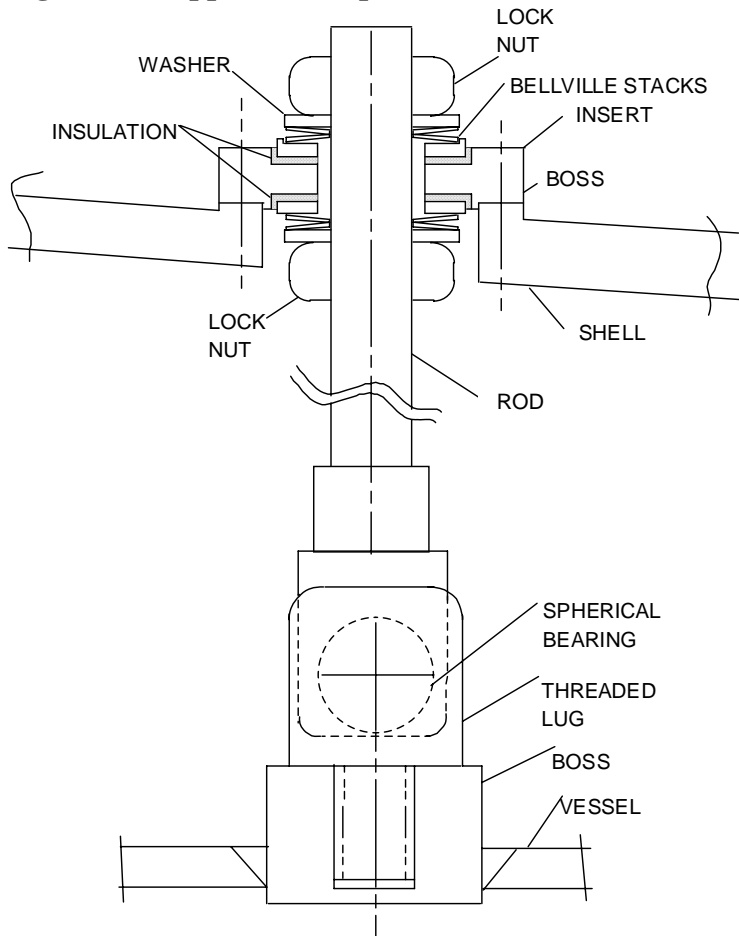

LOWER VESSEL HANGER CONCEPT

Materials

Strut Rod	6Al4V titanium or Inconel 718
Rod Diameter	0.75 inch diam
Effective Length	12 inches
Insulation Wrap	0.5 inch thick Microtherm around rod length
Washer	G-10 insulation

Figure 12 Support Rod Temperature During VV Bakeout

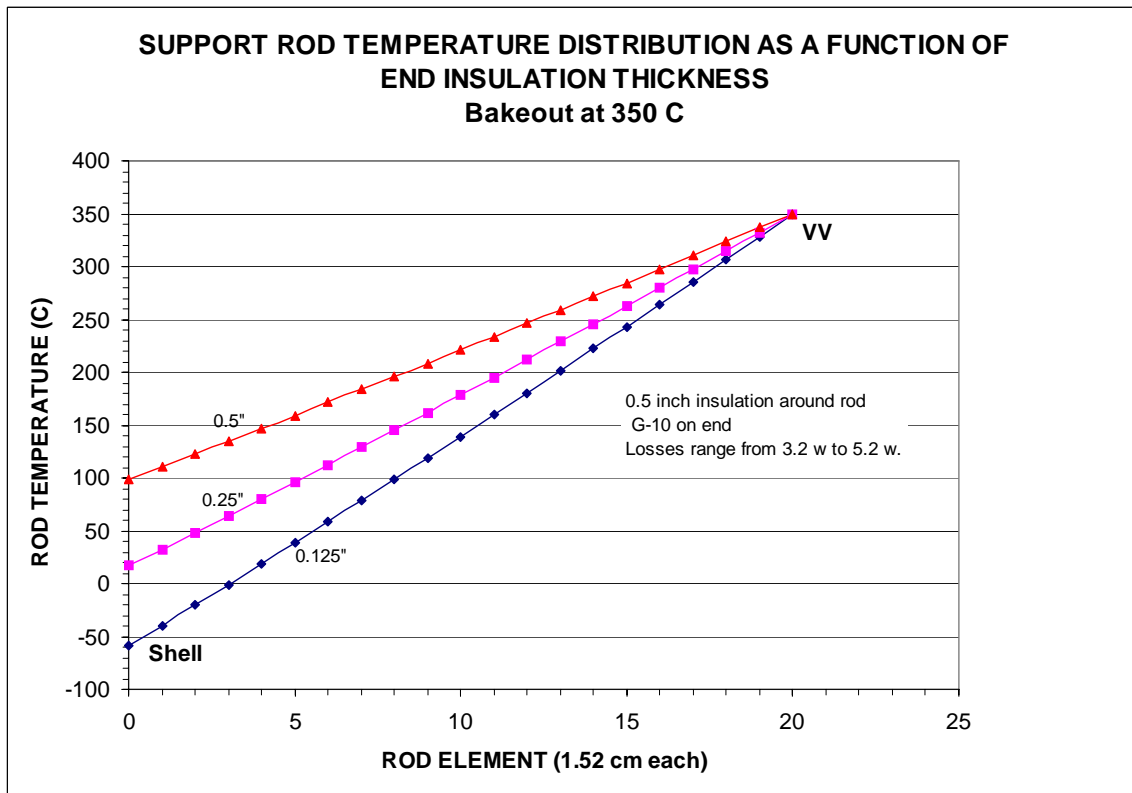
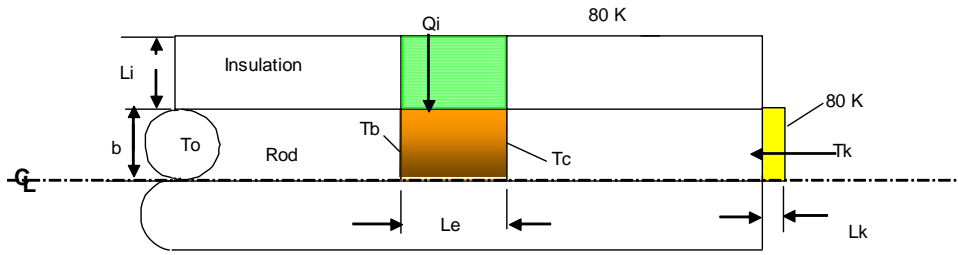

Bakeout Results

The heat losses are very minimal and do not influence the other VV heat balance calculations. The rod temperature distribution is driven primarily by the thickness of the insulation washer. A half inch thickness of insulation wrap is sufficient to limit the total losses to 3.2 w to 5.2 w per rod, most of which is lost axially. For the case using 0.5 inch insulation and losing 3.2 w, only 0.76 w is lost out the side into the MC structure. The effect of increasing end insulation thickness is to reduce the gradient in the rod and

increase its average temperature while reducing the overall heat loss. Losses for the system at operational temperature were also performed, the results indicating losses so low they may be neglected.

Summary

During 350 bakeout the vessel tracing will be required to supply on the order of 8.17 kW of heating to the vessel wall. During 150 bakeout the vessel tracing will be required to supply on the order of 4.75 kW of heating to the vessel wall. The port electrical heaters will have to supply on the order of 5.9 kW. During idle[pre-shot] operation these values drop to 1.02 kW and 4.7 kW respectively.

The port extensions need to have heat distributed evenly along their length, particularly during operation. Models representing heat added along the outer half of the extensions show portions of the pipe running well below room temperature [-15 C]. Attempts to boost the temperatures up to the required pre-shot temperature of 20 C results in very high temperatures at the port flanges. With heat added at the midway point, portions of the pipe run hot [102 C] and exceed the maximum permitted pre-shot operation temperature of 60 C. Total port coverage will make replacement of heaters very difficult or impossible since there is no access to the entire length of the extension once the vessel is assembled. The recommended solution is to add redundant heaters to the ports. An internal heater could be added inside the port on the vacuum side, in the event both heaters are lost.

The outside of the cryostat will run cold and result in condensate and icing unless the test cell dew point is kept below 15 C or a nominal amount of heat is supplied to its surface [on the order of 2.5 kW].

The cryostat gaseous nitrogen system will require 13.25 kW of cooling during bakeout and 8.1 kW during idle operation.

The modular coil liquid nitrogen system will require 3.1 kW of cooling during bakeout and 0.9 kW during idle operation.

Less than 30 w will be lost from the system through the six VV support rods.

Caveat: This analysis is strictly a global overview of the heat balance mechanisms at work in the vessel system; it is based on simple area/conduction relationships assuming perfect contact between components such as the modular coils and vessel and ignores details of the local geometry. It is meant as a first cut for design purposes and is useful for bounding the insulation requirements, power requirements, and tracing coolant parameters. It will be followed up by 3-D finite NASTRAN models which will more closely represent the actual geometry.